



84000

FEATURES:

Wall hugger power recliners with full footrest. Manual adjustable headrest on all items. Seat cushions with shaped foam + 1" layer of memory foam on top; arm with memory foam. Stitching: Small thread in fabric & large flat thread in leather.

OPTIONS

*Motorized headrest: \$305 ea. *N/A on stationary items.

*Motorized headrest \$305 +** Lumbar support & heated back \$385= \$690 ea. (Only on recliner items with arm).

**Attn: with BACK 2: available only on 30"seat widths | with BACK 4: available only with 22" seat depth.

Battery Pack: \$305/ea.

Foam: Extra firm \$35/seat.

Arm 7: Choice of with or without "Wood Insert" in arm. If with wood insert, specify colour.

Leg on 7.25 Arm: Metal: LG064 square (chrome) or LG196 cylinder (Chrome or Matte Black). Wood: LG008 (specify color).

Leg on D-BOX READY items: LG209 wood (specify color).

Seat Depth: 20" or 22".

HOME THEATRE Configurations

For Accessories, Cup holders & Configuration details, see page attached.

Accessory Dock : \$80 ea.

Cup Holders: Metal: \$90 ea. | LED lighted Cup Holder: \$90 ea. | *LED lighted Cup Holder with (1 or 2 motor) controls: \$125 ea.

*LED Light strip under seat: \$60/seat.

| Description | L x D x H | Leather | | | | | | Fabric | | |
|-------------------------------|---------------|---------|------|--|---|----------------------------------|---------------------------|--------|----------|-----------|
| | | 10 | 20 | 30 Bronx Hugo Illusion Tucson Utah Vintage Wild Laredo Yukon | 40 Cavallo Elegance Princess Santiago Sensation Sunset Trina Victoria | 50 Bull Cassiope Dublin | 60 Caress Ultrasued | A | B COM | C alta |
| 001 CHAIR | 38x40x33/40 | 3760 | 3975 | 4185 | 4400 | 4615 | 4830 | 3075 | 3150 | 3230 |
| 002 LOVESEAT | 62x40x33/40 | 5400 | 5640 | 5875 | 6110 | 6345 | 6585 | 4335 | 4470 | 4605 |
| 003 SOFA | 86x40x33/40 | 6515 | 6840 | 7170 | 7495 | 7820 | 8145 | 5245 | 5435 | 5625 |
| 005 LOUNGE CHAIR RIGHT ARM | 31x62x33/40 | 3535 | 3680 | 3825 | 3975 | 4120 | 4265 | 2825 | 2960 | 3095 |
| 009 ARMLESS LOVESEAT | 47x40x33/40 | 3780 | 3940 | 4095 | 4255 | 4410 | 4570 | 3015 | 3165 | 3310 |
| 011 LOUNGE CHAIR LEFT ARM | 31x62x33/40 | 3535 | 3680 | 3825 | 3975 | 4120 | 4265 | 2825 | 2960 | 3095 |
| 012 LOVESEAT LEFT ARM | 54x40x33/40 | 4660 | 4860 | 5065 | 5265 | 5470 | 5670 | 3715 | 3850 | 3985 |
| 017 DOUBLE CHAIR | 45x40x33/40 | 3960 | 4175 | 4390 | 4605 | 4815 | 5030 | 3175 | 3310 | 3445 |
| 021 APARTMENT SOFA NO ARM | 61x40x33/40 | 4275 | 4470 | 4660 | 4850 | 5040 | 5235 | 3330 | 3510 | 3690 |
| 040 ARMLESS SOFA | 71x40x33/40 | 4920 | 5130 | 5345 | 5560 | 5775 | 5985 | 3885 | 4075 | 4265 |
| 041 RECLINING CHAIR LEFT ARM | 31x40x33/40 | 3780 | 3915 | 4050 | 4185 | 4320 | 4455 | 3220 | 3320 | 3420 |
| 042 RECLINING CHAIR RIGHT ARM | 31x40x33/40 | 3780 | 3915 | 4050 | 4185 | 4320 | 4455 | 3220 | 3320 | 3420 |
| 044 RECLINER CHAIR | 38x40x33/40 | 4560 | 4760 | 4965 | 5165 | 5370 | 5570 | 3850 | 3930 | 4005 |
| 051 ARMLESS CHAIR | 23.5x40x33/40 | 2185 | 2295 | 2410 | 2520 | 2635 | 2745 | 1690 | 1790 | 1890 |
| 052 SOFA LEFT ARM | 78x40x33/40 | 5760 | 6010 | 6255 | 6505 | 6750 | 7000 | 4580 | 4785 | 4985 |
| 053 SOFA RIGHT ARM | 78x40x33/40 | 5760 | 6010 | 6255 | 6505 | 6750 | 7000 | 4580 | 4785 | 4985 |
| 056 CHAIR RIGHT ARM | 31x40x33/40 | 3030 | 3150 | 3275 | 3400 | 3525 | 3645 | 2385 | 2490 | 2590 |

84000

FEATURES:

Wall hugger power recliners with full footrest. Manual adjustable headrest on all items. Seat cushions with shaped foam + 1" layer of memory foam on top; arm with memory foam. Stitching: Small thread in fabric & large flat thread in leather.

OPTIONS

*Motorized headrest: \$305 ea. *N/A on stationary items.

*Motorized headrest \$305 +** Lumbar support & heated back \$385= \$690 ea. (Only on recliner items with arm).

**Attn: with BACK 2: available only on 30" seat widths | with BACK 4: available only with 22" seat depth.

Battery Pack: \$305/ea.

Foam: Extra firm \$35/seat.

Arm 7: Choice of with or without "Wood Insert" in arm. If with wood insert, specify colour.

Leg on 7.25 Arm: Metal: LG064 square (chrome) or LG196 cylinder (Chrome or Matte Black). Wood: LG008 (specify color).

Leg on D-BOX READY items: LG209 wood (specify color).

Seat Depth: 20" or 22".

HOME THEATRE Configurations

For Accessories, Cup holders & Configuration details, see page attached.

Accessory Dock : \$80 ea.

Cup Holders: Metal: \$90 ea. | LED lighted Cup Holder: \$90 ea. | *LED lighted Cup Holder with (1 or 2 motor) controls: \$125 ea.

*LED Light strip under seat: \$60/seat.

| Description | L x D x H | Leather | | | | | | Fabric | | |
|--------------------------------------|---------------|---------|------|--|---|----------------------------------|---------------------------|--------|----------|-----------|
| | | 10 | 20 | 30 Bronx Hugo Illusion Tucson Utah Vintage Wild Laredo Yukon | 40 Cavallo Elegance Princess Santiago Sensation Sunset Trina Victoria | 50 Bull Cassiope Dublin | 60 Caress Ultrasued | A | B COM | C alta |
| 057 CHAIR LEFT ARM | 31x40x33/40 | 3030 | 3150 | 3275 | 3400 | 3525 | 3645 | 2385 | 2490 | 2590 |
| 061 LOVESEAT RIGHT ARM | 54x40x33/40 | 4660 | 4860 | 5065 | 5265 | 5470 | 5670 | 3715 | 3850 | 3985 |
| 071 ARMLESS RECLINING CHAIR | 23.5x40x33/40 | 2940 | 3075 | 3210 | 3345 | 3480 | 3615 | 2520 | 2645 | 2770 |
| 095 APARTMENT SOFA | 76x40x33/40 | 5865 | 6165 | 6470 | 6775 | 7080 | 7380 | 4705 | 4875 | 5040 |
| 096 APARTMENT SOFA LEFT ARM | 68x40x33/40 | 5145 | 5380 | 5615 | 5850 | 6090 | 6325 | 4030 | 4200 | 4365 |
| 097 APARTMENT SOFA RIGHT ARM | 68x40x33/40 | 5145 | 5380 | 5615 | 5850 | 6090 | 6325 | 4030 | 4200 | 4365 |
| 124 STORAGE OTTOMAN | 30x22x17 | 1500 | 1555 | 1610 | 1665 | 1725 | 1780 | 1305 | 1330 | 1350 |
| 138 STRAIGHT ARM | 10x36x24.5 | 835 | 915 | 990 | 1070 | 1150 | 1230 | 700 | 745 | 790 |
| 159 WEDGE STORAGE | 11/27x36x24.5 | 1520 | 1575 | 1635 | 1690 | 1745 | 1800 | 1160 | 1195 | 1230 |
| 160 STRAIGHT STORAGE | 11x36x24.5 | 1430 | 1510 | 1590 | 1665 | 1745 | 1825 | 1105 | 1140 | 1170 |
| 165 DOUBLE RECLINING CHAIR | 45x40x33/40 | 4750 | 4950 | 5155 | 5355 | 5560 | 5760 | 4005 | 4155 | 4300 |
| 169 DOUBLE RECLINING CHAIR LEFT ARM | 38x40x33/40 | 3995 | 4165 | 4335 | 4500 | 4670 | 4840 | 3355 | 3490 | 3625 |
| 170 DOUBLE RECLINING CHAIR RIGHT ARM | 38x40x33/40 | 3995 | 4165 | 4335 | 4500 | 4670 | 4840 | 3355 | 3490 | 3625 |
| 171 ARMLESS DOUBLE RECLINING CHAIR | 30.5x40x33/40 | 3150 | 3275 | 3400 | 3525 | 3645 | 3770 | 2670 | 2790 | 2915 |
| 173 DOUBLE LOUNGE CHAIR LEFT ARM | 38x62x33/40 | 3825 | 4020 | 4210 | 4400 | 4590 | 4785 | 3075 | 3255 | 3435 |
| 174 DOUBLE LOUNGE CHAIR RIGHT ARM | 38x62x33/40 | 3825 | 4020 | 4210 | 4400 | 4590 | 4785 | 3075 | 3255 | 3435 |
| 175 DOUBLE CHAIR LEFT ARM | 38x40x33/40 | 3210 | 3365 | 3525 | 3680 | 3840 | 3995 | 2580 | 2715 | 2850 |
| 176 DOUBLE CHAIR RIGHT ARM | 38x40x33/40 | 3210 | 3365 | 3525 | 3680 | 3840 | 3995 | 2580 | 2715 | 2850 |

84000

FEATURES:

Wall hugger power recliners with full footrest. Manual adjustable headrest on all items. Seat cushions with shaped foam + 1" layer of memory foam on top; arm with memory foam. Stitching: Small thread in fabric & large flat thread in leather.

OPTIONS

*Motorized headrest: \$305 ea. *N/A on stationary items.

*Motorized headrest \$305 +** Lumbar support & heated back \$385= \$690 ea. (Only on recliner items with arm).

**Attn: with BACK 2: available only on 30" seat widths | with BACK 4: available only with 22" seat depth.

Battery Pack: \$305/ea.

Foam: Extra firm \$35/seat.

Arm 7: Choice of with or without "Wood Insert" in arm. If with wood insert, specify colour.

Leg on 7.25 Arm: Metal: LG064 square (chrome) or LG196 cylinder (Chrome or Matte Black). Wood: LG008 (specify color).

Leg on D-BOX READY items: LG209 wood (specify color).

Seat Depth: 20" or 22".

HOME THEATRE Configurations

For Accessories, Cup holders & Configuration details, see page attached.

Accessory Dock : \$80 ea.

Cup Holders: Metal: \$90 ea. | LED lighted Cup Holder: \$90 ea. | *LED lighted Cup Holder with (1 or 2 motor) controls: \$125 ea.

*LED Light strip under seat: \$60/seat.

| Description | L x D x H | Leather | | | | | | Fabric | | |
|--------------------------------------|--------------------|---------|------|--|---|----------------------------------|---------------------------|--------|----------|-----------|
| | | 10 | 20 | 30 Bronx Hugo Illusion Tucson Utah Vintage Wild Laredo Yukon | 40 Cavallo Elegance Princess Santiago Sensation Sunset Trina Victoria | 50 Bull Cassiope Dublin | 60 Caress Ultrasued | A | B COM | C alta |
| 177 ARMLESS DOUBLE CHAIR | 30.5x40x33/40 | 2365 | 2510 | 2655 | 2805 | 2950 | 3095 | 1835 | 1970 | 2105 |
| 190 SMALL WEDGE STORAGE | 11/21x36x24.5 | 1430 | 1510 | 1590 | 1665 | 1745 | 1825 | 1105 | 1140 | 1170 |
| 236 RECLINING LOUNGE CHAIR LEFT ARM | 31x62x33/40 | 4470 | 4615 | 4760 | 4905 | 5055 | 5200 | 3860 | 3995 | 4130 |
| 237 RECLINING LOUNGE CHAIR RIGHT ARM | 31x62x33/40 | 4470 | 4615 | 4760 | 4905 | 5055 | 5200 | 3860 | 3995 | 4130 |
| 238 RECLINING DBL LOUNGE CHAIR L-ARM | 38x62x33/40 | 4760 | 4950 | 5145 | 5335 | 5525 | 5715 | 4030 | 4210 | 4390 |
| 239 RECLINING DBL LOUNGE CHAIR R-ARM | 38x62x33/40 | 4760 | 4950 | 5145 | 5335 | 5525 | 5715 | 4030 | 4210 | 4390 |
| V51 WINE GLASS HOLDER | 3.5 x 5.5 x 6.5 | 80 | 80 | 80 | 80 | 80 | 80 | 80 | 80 | 80 |
| V52 PLASTIC SWIVEL TRAY | 13 3/8 x 9 5/8 | 80 | 80 | 80 | 80 | 80 | 80 | 80 | 80 | 80 |
| V53 WOOD IMITATION SWIVEL TRAY | 19 x 10 | 135 | 135 | 135 | 135 | 135 | 135 | 135 | 135 | 135 |
| V54 TABLET HOLDER | 4.5 x 8 x 10 | 90 | 90 | 90 | 90 | 90 | 90 | 90 | 90 | 90 |
| V55 FLEXIBLE SHAFT LIGHT | 1.5x5x14 pli /bent | 80 | 80 | 80 | 80 | 80 | 80 | 80 | 80 | 80 |



EXECUTIVE

HOME THEATRE COLLECTION

TO CONFIGURE YOUR CHAIR, YOU MUST CHOOSE 1 BACK, 1 SEAT AND 1 ARM
EXAMPLE: 84 - **2** - **1** - **1** = 84 211
BACK-SEAT-ARM



Back items



BACK 1
WITH MANUAL OR
*ELECTRIC HEADREST

*Optional Lumbar Support
& Heated Back available on:
- Seat Width: 23" or 30"
- Seat Depth: 20" or 22"



BACK 2
WITH MANUAL OR
*ELECTRIC HEADREST

*Optional Lumbar Support
& Heated Back available on:
- Seat Width: **30"** wide only
- Seat Depth: 20" or 22"



BACK 4
WITH MANUAL OR
*ELECTRIC HEADREST

*Optional Lumbar Support
& Heated Back available on:
- Seat Width: 23" or 30"
- Seat Depth: **22"** only

SEAT



SEAT 1
FULL LEG POWER RECLINER SEAT

ARM items, all 7,25" wide



ARM 1



ARM 6



ARM 7



ARM 8



ARM 9

SPECIFICATIONS

- Manual adjustable headrest or Electric headrest
- Full leg power recliner
- Wall hugger mechanism
- Shaped foam & memory foam
- Large flat thread for covers in leather



Back & Seat Depth 23" or 30"



Seat Depth 20" or 22"



Accessories



Accessory Dock



Wood Tray Table (Choice of 8 colors)



Plastic Tray Table



Wine Glass Holder



LED Lamp



Tablet Holder

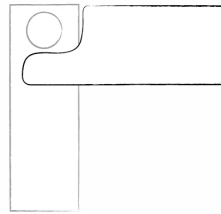

Coming soon
Wood rectangular tray table

Cupholders



Silver



Matte Black



Brown



LED Lighted Cupholder



LED Lighted Cupholder with Single Motor Control,
USB Port and LED Baserail



LED Lighted Cupholder with Double Motor Control,
USB Port and LED Baserail



SPECIFICATIONS

- Ⓐ 40" Total Height
- Ⓑ 33" Height headrest down
- Ⓒ 19,5" Seat height
- Ⓓ 65" Depth fully reclined
- Ⓔ 20" or 22" Seat depth
- Ⓕ 37,5" Depth with headrest up
- Ⓖ 24,5" Arm Height
- Ⓗ 7,25" Arm Width

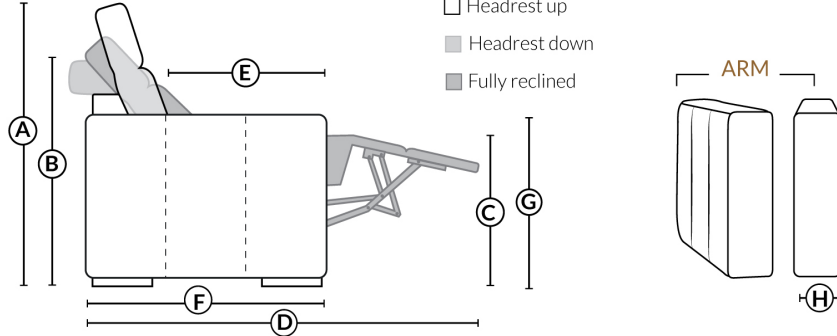

23" SEAT WIDTH

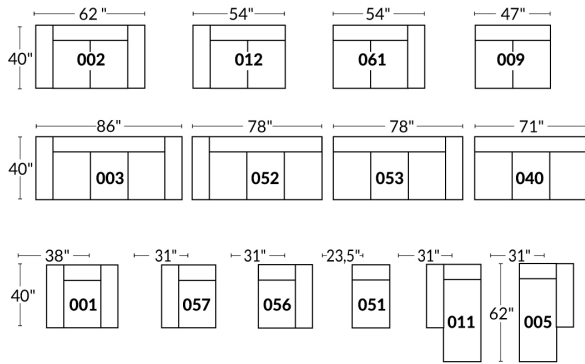

Power recliner Items

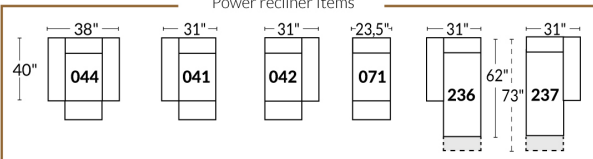

30" SEAT WIDTH

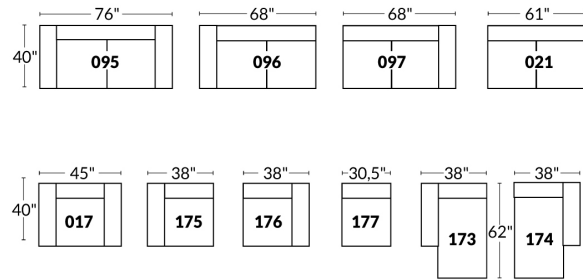

Power recliner Items

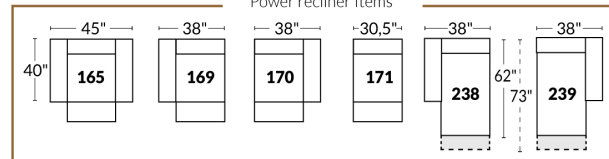

Others

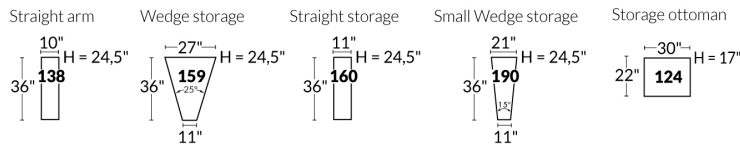

23" EXAMPLES

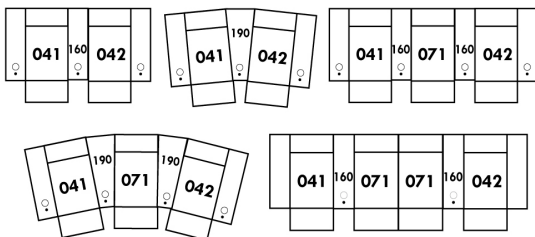

30" EXAMPLES

