

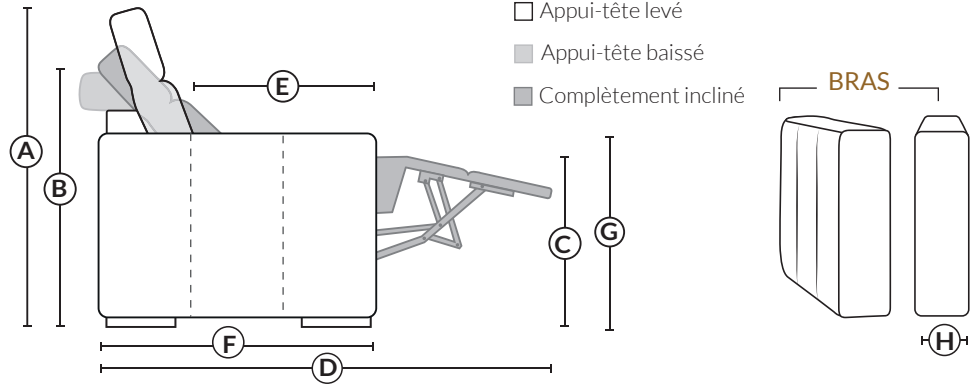

SPÉCIFICATIONS

- Ⓐ 40" Hauteur complète
- Ⓑ 33" Hauteur appui-tête baissé
- Ⓒ 19,5" Hauteur du siège
- Ⓓ 65" Profondeur inclinée
- Ⓔ 20" or 22" Profondeur assise
- Ⓕ 37,5" Profondeur appui-tête monté
- Ⓖ 24,5" Hauteur de bras
- Ⓗ 7,25" Largeur de bras



SIÈGE 23" DE LARGE

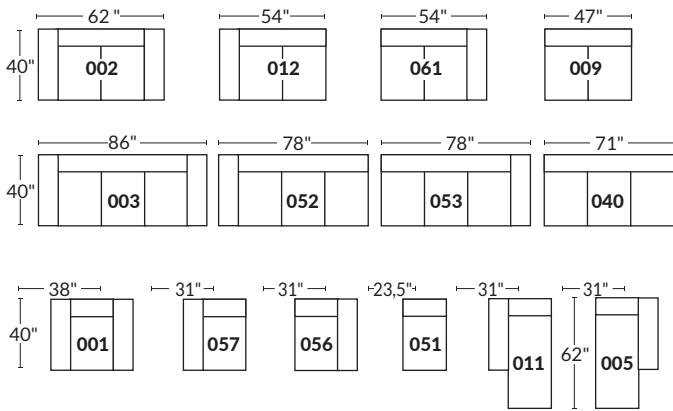

Items inclinables motorisés

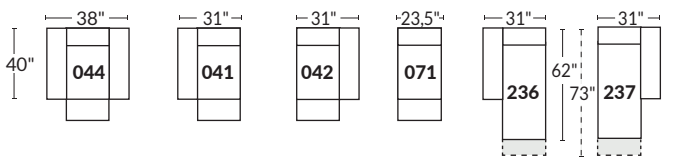

SIÈGE 30" DE LARGE

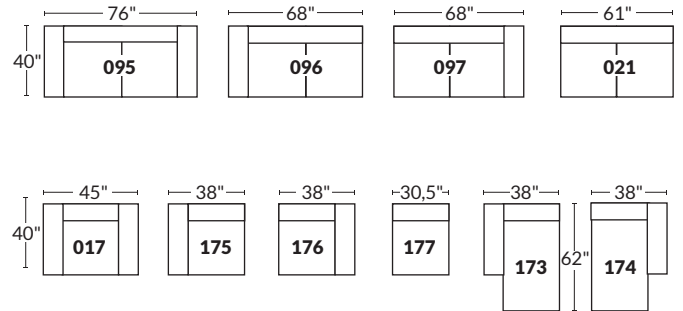

Items inclinables motorisés

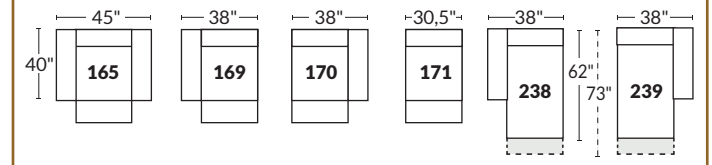

Autres

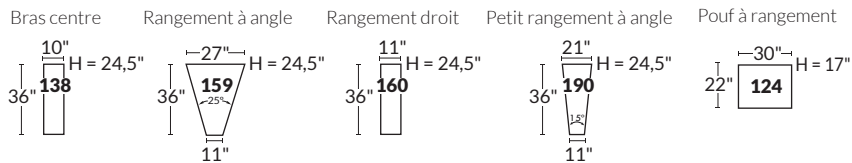

23" EXEMPLES

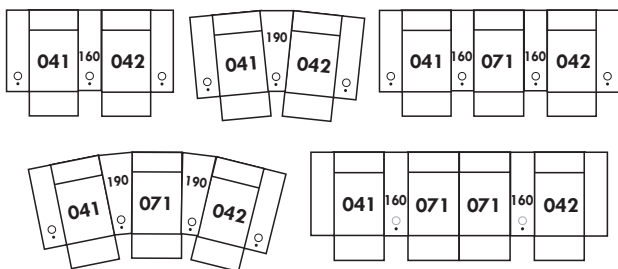

30" EXEMPLES

