

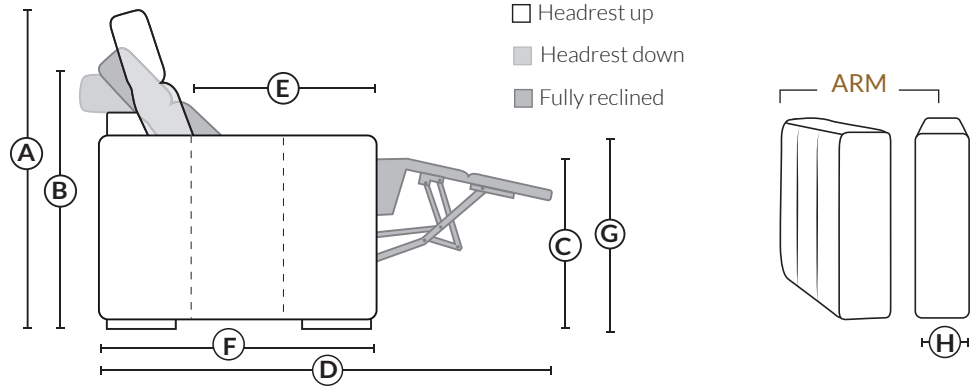

SPECIFICATIONS

- Ⓐ 40" Total Height
- Ⓑ 33" Height headrest down
- Ⓒ 19,5" Seat height
- Ⓓ 65" Depth fully reclined
- Ⓔ 20" or 22" Seat depth
- Ⓕ 37,5" Depth with headrest up
- Ⓖ 24,5" Arm Height
- Ⓗ 7,25" Arm Width



23" SEAT WIDTH

SKUS

30" SEAT WIDTH

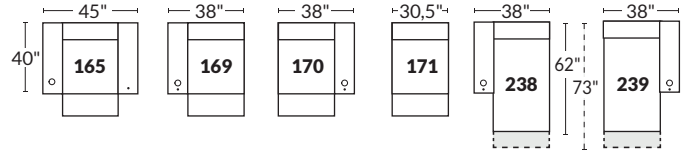
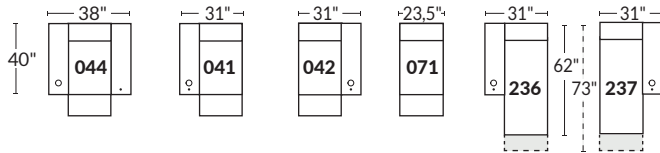

Others

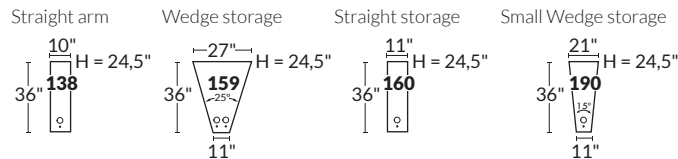

23" SEAT WIDTH

CONFIGURATION EXAMPLES

30" SEAT WIDTH

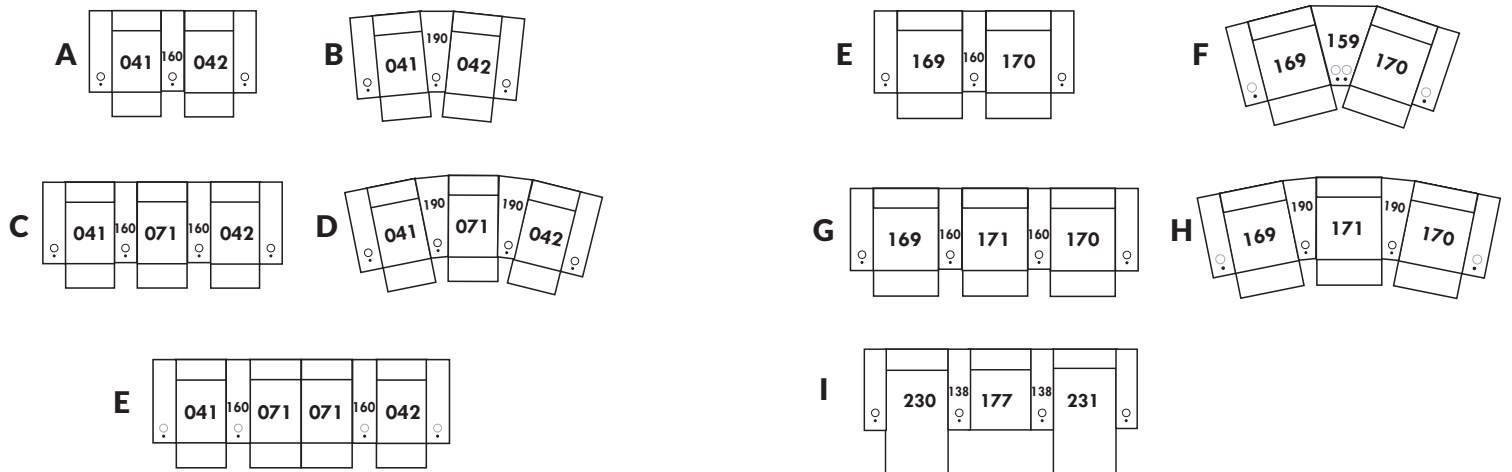



SPECIFICATIONS

- Ⓐ 40" Total Height
- Ⓑ 33" Height headrest down
- Ⓒ 19,5" Seat height
- Ⓓ 65" Depth fully reclined
- Ⓔ 20" or 22" Seat depth
- Ⓕ 37,5" Depth with headrest up
- Ⓖ 24,5" Arm Height
- Ⓗ 7,25" Arm Width

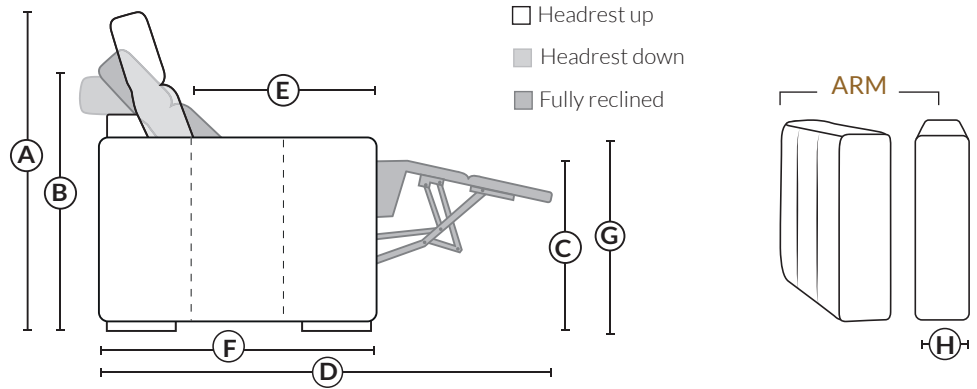

23" SEAT WIDTH

SKUS

30" SEAT WIDTH

D-BOX

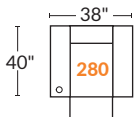

23" POWER RECLINER SEAT

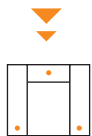

3 actuators

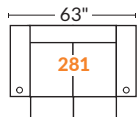

POWER RECLINER LOVESEAT

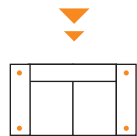

4 actuators

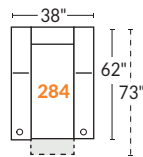

23" POWER RECLINER LOUNGE CHAIR

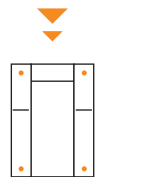

4 actuators

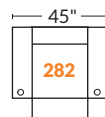

30" POWER RECLINER SEAT

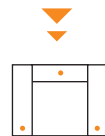

3 actuators

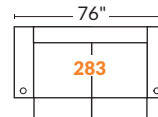

POWER RECLINER APARTEMENT SOFA

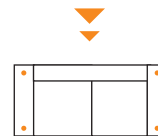

4 actuators

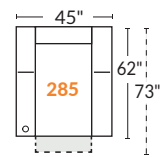

30" POWER RECLINER LOUNGE CHAIR

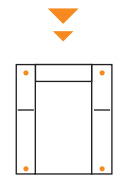

4 actuators

MULTIPLE SEATS

Leave a clearance of 4" between each D-BOX chair to not block the range of motion.

If the chair is near a wall, allow 6" of clearance.

*Up totwenty (20) seats can be connected to the HaptiSync Hub.

