



## CDN Volume Price List

January 19, 2022

|                      |                         |
|----------------------|-------------------------|
| <u>Customer Code</u> | <u>M0950</u>            |
| <u>Customer Name</u> | <u>MYHOME FURNITURE</u> |
| <u>Address</u>       | <u>FOR PRICE LIST</u>   |
|                      | <u> </u>                |



## CDN Price List

### 00200

Factory select: \$99.

To order "Earth tone" (Brown tones): code 3220#1.

To order "Neutral tone" (Beige, black or white): code 3221#1.

To order "Euro tone" (Brick, Red, Yellow or Blue): code 3222#1.

| Description       | L x D x H | Leather |                       |  |  |                                  |                           | Fabric |          |           |
|-------------------|-----------|---------|-----------------------|--|--|----------------------------------|---------------------------|--------|----------|-----------|
|                   |           | 10      | 20<br>Madras<br>Softy | 30<br>Hugo<br>Fantasy<br>Illusion<br>Tucson<br>Utah<br>Vintage<br>Wild Laredo<br>Yukon | 40<br>Elegance<br>Princess<br>Santiago<br>Sensation<br>Sunset<br>Trina<br>Victoria | 50<br>Bull<br>Cassiope<br>Dublin | 60<br>Caress<br>Ultrasued | A      | B<br>COM | C<br>alta |
| 006 OTTOMAN       | 19X19X17  | 340     | 355                   | 370  | 385  | 400                              | 415                       | 215    | 235      | 255       |
| 181 ROUND OTTOMAN | 16X16X16  | 330     | 350                   | 370  | 390  | 410                              | 430                       | 215    | 235      | 255       |



## CDN Price List

00224

Specify on your order:

Leg: LG8 wood (specify colour) or LG64 metal.  
Decorative Nail Option: \$50 upcharge.

When ordering this style, specify which Jaymar style you would like us to match the stitching.

| Description         | L x D x H | Leather |                       |  |  |                                  |                           | Fabric |          |           |
|---------------------|-----------|---------|-----------------------|--|--|----------------------------------|---------------------------|--------|----------|-----------|
|                     |           | 10      | 20<br>Madras<br>Softy | 30<br>Hugo<br>Fantasy<br>Illusion<br>Tucson<br>Utah<br>Vintage<br>Wild Laredo<br>Yukon | 40<br>Elegance<br>Princess<br>Santiago<br>Sensation<br>Sunset<br>Trina<br>Victoria | 50<br>Bull<br>Cassiope<br>Dublin | 60<br>Caress<br>Ultrasued | A      | B<br>COM | C<br>alta |
| 124 STORAGE OTTOMAN | 36X24X18  | 865     | 950                   | 1035   | 1120   | 1205                             | 1290                      | 690    | 725      | 760       |



## CDN Price List

### 00236

Specify on your order:

Legs: LG8 wood (specify colour) or LG64 metal.  
 Decorative Nail Option: \$75 upcharge.

When ordering this style, specify which Jaymar style you would like us to match the stitching.

| Description         | L x D x H | Leather |                       |  |  |                                  |                           | Fabric |          |           |
|---------------------|-----------|---------|-----------------------|--|--|----------------------------------|---------------------------|--------|----------|-----------|
|                     |           | 10      | 20<br>Madras<br>Softy | 30<br>Hugo<br>Fantasy<br>Illusion<br>Tucson<br>Utah<br>Vintage<br>Wild Laredo<br>Yukon | 40<br>Elegance<br>Princess<br>Santiago<br>Sensation<br>Sunset<br>Trina<br>Victoria | 50<br>Bull<br>Cassiope<br>Dublin | 60<br>Caress<br>Ultrasued | A      | B<br>COM | C<br>alta |
| 124 STORAGE OTTOMAN | 36X36X18  | 1015    | 1100                  | 1185   | 1270   | 1355                             | 1440                      | 875    | 910      | 945       |





## CDN Price List

00252

| Description       | L x D x H | Leather |                       |  |  |                                  |                           | Fabric |          |           |
|-------------------|-----------|---------|-----------------------|--|--|----------------------------------|---------------------------|--------|----------|-----------|
|                   |           | 10      | 20<br>Madras<br>Softy | 30<br>Hugo<br>Fantasy<br>Illusion<br>Tucson<br>Utah<br>Vintage<br>Wild Laredo<br>Yukon | 40<br>Elegance<br>Princess<br>Santiago<br>Sensation<br>Sunset<br>Trina<br>Victoria | 50<br>Bull<br>Cassiope<br>Dublin | 60<br>Caress<br>Ultrasued | A      | B<br>COM | C<br>alta |
| 115 LARGE OTTOMAN | 52X25X18  | 775     | 850                   | 925  | 1000   | 1075                             | 1150                      | 595    | 630      | 665       |



## CDN Price List

### APPUI-BRAS/ARMREST

Metal Cup holder included; specify colour stainless, matte black or brown.

| Description                           | L x D x H     | Leather |                       |  |  |                                  |                           | Fabric |          |           |
|---------------------------------------|---------------|---------|-----------------------|--|--|----------------------------------|---------------------------|--------|----------|-----------|
|                                       |               | 10      | 20<br>Madras<br>Softy | 30<br>Hugo<br>Fantasy<br>Illusion<br>Tucson<br>Utah<br>Vintage<br>Wild Laredo<br>Yukon | 40<br>Elegance<br>Princess<br>Santiago<br>Sensation<br>Sunset<br>Trina<br>Victoria | 50<br>Bull<br>Cassiope<br>Dublin | 60<br>Caress<br>Ultrasued | A      | B<br>COM | C<br>alta |
| 149 UNIVERSAL ARMREST - 1 CUP HOLDER  | 6.5X20X4.5/10 | 195     | 210                   | 225  | 240  | 255                              | 270                       | 150    | 155      | 160       |
| 193 UNIVERSAL ARMREST - 2 CUP HOLDERS | 6.5X20X4.5/10 | 215     | 230                   | 245  | 260  | 275                              | 290                       | 160    | 170      | 180       |



## CDN Price List

### RONDO TABLE

Option: Plexiglass table top \$150.

| Description           | L x D x H | Leather |                       |  |  |                                  |                           | Fabric |          |           |
|-----------------------|-----------|---------|-----------------------|--|--|----------------------------------|---------------------------|--------|----------|-----------|
|                       |           | 10      | 20<br>Madras<br>Softy | 30<br>Hugo<br>Fantasy<br>Illusion<br>Tucson<br>Utah<br>Vintage<br>Wild Laredo<br>Yukon | 40<br>Elegance<br>Princess<br>Santiago<br>Sensation<br>Sunset<br>Trina<br>Victoria | 50<br>Bull<br>Cassiope<br>Dublin | 60<br>Caress<br>Ultrasued | A      | B<br>COM | C<br>alta |
| 077 UPHOLSTERED TABLE | 42X42X12  | 485     | 520                   | 555  | 590  | 625                              | 660                       | 335    | 360      | 385       |



## CDN Price List

93

Specify colour of legs LG129 and LG98.  
Specify colour of legs for ottoman LG81.

| Description | L x D x H | Leather |                       |  |  |                                  |                           | Fabric |          |           |
|-------------|-----------|---------|-----------------------|--|--|----------------------------------|---------------------------|--------|----------|-----------|
|             |           | 10      | 20<br>Madras<br>Softy | 30<br>Hugo<br>Fantasy<br>Illusion<br>Tucson<br>Utah<br>Vintage<br>Wild Laredo<br>Yukon | 40<br>Elegance<br>Princess<br>Santiago<br>Sensation<br>Sunset<br>Trina<br>Victoria | 50<br>Bull<br>Cassiope<br>Dublin | 60<br>Caress<br>Ultrasued | A      | B<br>COM | C<br>alta |
| 001 CHAIR   | 30X33X35  | 1365    | 1445                  | 1525   | 1605   | 1685                             | 1765                      | 1055   | 1105     | 1155      |
| 006 OTTOMAN | 27X21X18  | 720     | 745                   | 770  | 795  | 820                              | 845                       | 495    | 505      | 515       |



## CDN Price List

### 204

Ideal for Dining room. Superior comfort with memory foam.

Factory select round or square 19" ottoman: \$115.

Factory select round or square 26" ottoman: \$145.

To order "Earth tone" (Brown tones): code 3220#1.

To order "Neutral tone" (Beige, black or white): code 3221#1.

To order "Euro tone" (Brick, Red, Yellow or Blue): code 3222#1.

| Description                             | L x D x H | Leather |                       |  |  |                                  |                           | Fabric |          |           |
|---|-----------|---------|-----------------------|--|--|----------------------------------|---------------------------|--------|----------|-----------|
|   |           | 10      | 20<br>Madras<br>Softy | 30<br>Hugo<br>Fantasy<br>Illusion<br>Tucson<br>Utah<br>Vintage<br>Wild Laredo<br>Yukon | 40<br>Elegance<br>Princess<br>Santiago<br>Sensation<br>Sunset<br>Trina<br>Victoria | 50<br>Bull<br>Cassiope<br>Dublin | 60<br>Caress<br>Ultrasued | A      | B<br>COM | C<br>alta |
| 182 ROUND OTTOMAN 19" CHAIR HEIGHT      | 17x17x19  | 340     | 355                   | 370  | 385  | 400                              | 415                       | 275    | 300      | 325       |
| 183 ROUND OTTOMAN 26" BAR STOOL HEIGHT  | 17x17x26  | 415     | 440                   | 465  | 490  | 515                              | 540                       | 350    | 370      | 390       |
| 184 SQUARE OTTOMAN 19" CHAIR HEIGHT     | 18x18x19  | 340     | 355                   | 370  | 385  | 400                              | 415                       | 275    | 300      | 325       |
| 185 SQUARE OTTOMAN 26" BAR STOOL HEIGHT | 18x18x26  | 415     | 440                   | 465  | 490  | 515                              | 540                       | 350    | 370      | 390       |



## 360

This swivel chair comes with 3 decorative cushions (1 Large & 2 small)

Specifications:  
Seat Height: 16.5"  
Seat Depth: 37"  
Seat Width: 37"  
Arm Height: 29"

OPTIONS:  
Combo: On 3 decorative cushions. Specify cover #2.  
Swivel Wood Base: Specify colour.

| Description      | L x D x H    | Leather |                       |  |  |                                  |                           | Fabric |          |           |
|------------------|--------------|---------|-----------------------|--|--|----------------------------------|---------------------------|--------|----------|-----------|
|                  |              | 10      | 20<br>Madras<br>Softy | 30<br>Hugo<br>Fantasy<br>Illusion<br>Tucson<br>Utah<br>Vintage<br>Wild Laredo<br>Yukon | 40<br>Elegance<br>Princess<br>Santiago<br>Sensation<br>Sunset<br>Trina<br>Victoria | 50<br>Bull<br>Cassiope<br>Dublin | 60<br>Caress<br>Ultrasued | A      | B<br>COM | C<br>alta |
| 015 SWIVEL CHAIR | 47 x 41 x 29 | 1590    | 1640                  | 1690   | 1740   | 1790                             | 1840                      | 1050   | 1085     | 1120      |



## CDN Price List

503

COMBO: Cover #1: Back . / Cover #2: Seat & Front Rail.  
COMBO PRICE: See "Product Knowledge Booklet".

| Description      | L x D x H  | Leather |                       |  |  |                                  |                           | Fabric |          |           |
|------------------|------------|---------|-----------------------|--|--|----------------------------------|---------------------------|--------|----------|-----------|
|                  |            | 10      | 20<br>Madras<br>Softy | 30<br>Hugo<br>Fantasy<br>Illusion<br>Tucson<br>Utah<br>Vintage<br>Wild Laredo<br>Yukon | 40<br>Elegance<br>Princess<br>Santiago<br>Sensation<br>Sunset<br>Trina<br>Victoria | 50<br>Bull<br>Cassiope<br>Dublin | 60<br>Caress<br>Ultrasued | A      | B<br>COM | C<br>alta |
| 015 SWIVEL CHAIR | 31x31x31.5 | 1060    | 1105                  | 1150   | 1195   | 1240                             | 1285                      | 825    | 875      | 925       |



## CDN Price List

### 506

COMBO: Cover #1: Back & Arms. / Cover #2: Seat & Front Rail.  
COMBO PRICE: See "Product Knowledge Booklet".

OPTION: Wood Base: add 50\$ (specify colour).

| Description      | L x D x H  | Leather |                       |  |  |                                  |                           | Fabric |          |           |
|------------------|------------|---------|-----------------------|--|--|----------------------------------|---------------------------|--------|----------|-----------|
|                  |            | 10      | 20<br>Madras<br>Softy | 30<br>Hugo<br>Fantasy<br>Illusion<br>Tucson<br>Utah<br>Vintage<br>Wild Laredo<br>Yukon | 40<br>Elegance<br>Princess<br>Santiago<br>Sensation<br>Sunset<br>Trina<br>Victoria | 50<br>Bull<br>Cassiope<br>Dublin | 60<br>Caress<br>Ultrasued | A      | B<br>COM | C<br>alta |
| 015 SWIVEL CHAIR | 31X31X31.5 | 1005    | 1055                  | 1105   | 1155   | 1205                             | 1255                      | 785    | 830      | 875       |





## CDN Price List

### 507

Specify colour of legs LG168 for type 001.  
COMBO: Cover #2 on back, seat and headrest.

| Description              | L x D x H  | Leather |                       |  |  |                                  |                           | Fabric |          |           |
|--------------------------|------------|---------|-----------------------|--|--|----------------------------------|---------------------------|--------|----------|-----------|
|                          |            | 10      | 20<br>Madras<br>Softy | 30<br>Hugo<br>Fantasy<br>Illusion<br>Tucson<br>Utah<br>Vintage<br>Wild Laredo<br>Yukon | 40<br>Elegance<br>Princess<br>Santiago<br>Sensation<br>Sunset<br>Trina<br>Victoria | 50<br>Bull<br>Cassiope<br>Dublin | 60<br>Caress<br>Ultrasued | A      | B<br>COM | C<br>alta |
| 001 CHAIR                | 28.5X34X35 | 1065    | 1120                  | 1175   | 1230   | 1285                             | 1340                      | 785    | 830      | 875       |
| 243 SWIVEL ROCKING CHAIR | 28.5X34X35 | 1135    | 1195                  | 1255   | 1315   | 1375                             | 1435                      | 880    | 910      | 940       |



## CDN Price List

### 509

LEGS: LG153 wood; specify colour of wood legs.

DECORATIVE NAILS: On chair back and base; add \$75. Specify colour of nails: Pewter or Brass.

| Description | L x D x H | Leather |                       |  |  |                                  |                           | Fabric |          |           |
|-------------|-----------|---------|-----------------------|--|--|----------------------------------|---------------------------|--------|----------|-----------|
|             |           | 10      | 20<br>Madras<br>Softy | 30<br>Hugo<br>Fantasy<br>Illusion<br>Tucson<br>Utah<br>Vintage<br>Wild Laredo<br>Yukon | 40<br>Elegance<br>Princess<br>Santiago<br>Sensation<br>Sunset<br>Trina<br>Victoria | 50<br>Bull<br>Cassiope<br>Dublin | 60<br>Caress<br>Ultrasued | A      | B<br>COM | C<br>alta |
| 001 CHAIR   | 29X36X31  | 1240    | 1290                  | 1340   | 1390   | 1440                             | 1490                      | 900    | 935      | 970       |
| 006 OTTOMAN | 23X22X14  | 525     | 570                   | 615  | 660  | 705                              | 750                       | 410    | 420      | 430       |



## CDN Price List

515

Specify wood leg colour LG01.

Depth of chair fully reclined 67". / Distance from wall: 18".

| Description        | L x D x H | Leather |                       |  |  |                                  |                           | Fabric |          |           |
|--------------------|-----------|---------|-----------------------|--|--|----------------------------------|---------------------------|--------|----------|-----------|
|                    |           | 10      | 20<br>Madras<br>Softy | 30<br>Hugo<br>Fantasy<br>Illusion<br>Tucson<br>Utah<br>Vintage<br>Wild Laredo<br>Yukon | 40<br>Elegance<br>Princess<br>Santiago<br>Sensation<br>Sunset<br>Trina<br>Victoria | 50<br>Bull<br>Cassiope<br>Dublin | 60<br>Caress<br>Ultrasued | A      | B<br>COM | C<br>alta |
| 044 RECLINER CHAIR | 32x35x41  | 1750    | 1820                  | 1890   | 1960   | 2030                             | 2100                      | 1355   | 1390     | 1425      |



## DISCOVERY

FEATURES: This swivel chair comes with a small back cushion.

Specifications:

Seat Height: 17"

Seat Depth: 23"

Seat Width: 22.5"

Arm Height: 27.5"

OPTIONS:

Contrast Piping: in fabric or leather - Specify cover.

Combo price small back cushion:

Chair in fabric / small back cushion in leather, add \$40. (Specify leather & colour)

Chair in leather / small back cushion in fabric; no charge. (Specify fabric & colour)

Wood swivel base: Specify Colour

| Description      | L x D x H        | Leather |                       |  |  |                                  |                           | Fabric |          |           |
|------------------|------------------|---------|-----------------------|--|--|----------------------------------|---------------------------|--------|----------|-----------|
|                  |                  | 10      | 20<br>Madras<br>Softy | 30<br>Hugo<br>Fantasy<br>Illusion<br>Tucson<br>Utah<br>Vintage<br>Wild Laredo<br>Yukon | 40<br>Elegance<br>Princess<br>Santiago<br>Sensation<br>Sunset<br>Trina<br>Victoria | 50<br>Bull<br>Cassiope<br>Dublin | 60<br>Caress<br>Ultrasued | A      | B<br>COM | C<br>alta |
| 015 SWIVEL CHAIR | 36.5 x 33.5 x 34 | 1300    | 1350                  | 1400   | 1450   | 1500                             | 1550                      | 900    | 935      | 970       |



## KIRK

FEATURES: Upholstered seat cushions with high quality 2.5 lb. density shaped foam and a 1" layer of memory foam.

Recommended in plain fabric only. In fabric, thread size will be smaller.

IN LEATHER available with CONTRASTING THREAD: Upcharge of \$50/piece. Specify thread number: 005-Black, 087-Beige, 103-Brown, 111-White.

Specify colour of base in wood.

| Description              | L x D x H  | Leather |                       |  |  |                                  |                           | Fabric |          |           |
|--------------------------|------------|---------|-----------------------|--|--|----------------------------------|---------------------------|--------|----------|-----------|
|                          |            | 10      | 20<br>Madras<br>Softy | 30<br>Hugo<br>Fantasy<br>Illusion<br>Tucson<br>Utah<br>Vintage<br>Wild Laredo<br>Yukon | 40<br>Elegance<br>Princess<br>Santiago<br>Sensation<br>Sunset<br>Trina<br>Victoria | 50<br>Bull<br>Cassiope<br>Dublin | 60<br>Caress<br>Ultrasued | A      | B<br>COM | C<br>alta |
| 015 SWIVEL CHAIR         | 31.5X34X34 | 1720    | 1780                  | 1840   | 1900   | 1960                             | 2020                      | 1340   | 1360     | 1380      |
| 243 SWIVEL ROCKING CHAIR | 31.5X34X34 | 1825    | 1885                  | 1945   | 2005   | 2065                             | 2125                      | 1450   | 1480     | 1510      |



## CDN Price List

### LA 1956

Metal swivel base.

Specs: Arm Height: 27". Seat Height: 18 1/2". Seat Depth: 19 1/2".

COMBO: Cover #1: Back & Arms. / Cover #2: Seat & Front Rail. For combo price: see "Product Knowledge" booklet.

| Description      | L x D x H    | Leather |                       |  |  |                                  |                           | Fabric |          |           |
|------------------|--------------|---------|-----------------------|--|--|----------------------------------|---------------------------|--------|----------|-----------|
|                  |              | 10      | 20<br>Madras<br>Softy | 30<br>Hugo<br>Fantasy<br>Illusion<br>Tucson<br>Utah<br>Vintage<br>Wild Laredo<br>Yukon | 40<br>Elegance<br>Princess<br>Santiago<br>Sensation<br>Sunset<br>Trina<br>Victoria | 50<br>Bull<br>Cassiope<br>Dublin | 60<br>Caress<br>Ultrasued | A      | B<br>COM | C<br>alta |
| 015 SWIVEL CHAIR | 31 x 29 x 31 | 1155    | 1210                  | 1265   | 1320   | 1375                             | 1430                      | 955    | 990      | 1025      |



## LINEAIRE I

Chair with upholstered arms.

Specifications:  
Seat Height: 15.5"  
Seat Depth: 23"  
Seat Width: 22"  
Arm Height: 21"

| Description | L x D x H    | Leather |                       |  |  |                                  |                           | Fabric |          |           |
|-------------|--------------|---------|-----------------------|--|--|----------------------------------|---------------------------|--------|----------|-----------|
|             |              | 10      | 20<br>Madras<br>Softy | 30<br>Hugo<br>Fantasy<br>Illusion<br>Tucson<br>Utah<br>Vintage<br>Wild Laredo<br>Yukon | 40<br>Elegance<br>Princess<br>Santiago<br>Sensation<br>Sunset<br>Trina<br>Victoria | 50<br>Bull<br>Cassiope<br>Dublin | 60<br>Caress<br>Ultrasued | A      | B<br>COM | C<br>alta |
| 001 CHAIR   | 28 x 35 x 31 | 1000    | 1050                  | 1100   | 1150   | 1200                             | 1250                      | 750    | 785      | 820       |



## LINEAIRE II

Chair with wood insert in arms. Specify colour.

Specifications:  
Seat Height: 15.5"  
Seat Depth: 23"  
Seat Width: 22"  
Arm Height: 21"

| Description | L x D x H    | Leather |                       |  |  |                                  |                           | Fabric |          |           |
|-------------|--------------|---------|-----------------------|--|--|----------------------------------|---------------------------|--------|----------|-----------|
|             |              | 10      | 20<br>Madras<br>Softy | 30<br>Hugo<br>Fantasy<br>Illusion<br>Tucson<br>Utah<br>Vintage<br>Wild Laredo<br>Yukon | 40<br>Elegance<br>Princess<br>Santiago<br>Sensation<br>Sunset<br>Trina<br>Victoria | 50<br>Bull<br>Cassiope<br>Dublin | 60<br>Caress<br>Ultrasued | A      | B<br>COM | C<br>alta |
| 001 CHAIR   | 28 x 35 x 31 | 1130    | 1180                  | 1230   | 1280   | 1330                             | 1380                      | 930    | 965      | 1000      |





## LINEAIRE III

Chair with wood arms. Specify colour.

Specifications:  
Seat Height: 15.5"  
Seat Depth: 23"  
Seat Width: 22"  
Arm Height: 21"

| Description | L x D x H      | Leather |                       |  |  |                                  |                           | Fabric |          |           |
|-------------|----------------|---------|-----------------------|--|--|----------------------------------|---------------------------|--------|----------|-----------|
|             |                | 10      | 20<br>Madras<br>Softy | 30<br>Hugo<br>Fantasy<br>Illusion<br>Tucson<br>Utah<br>Vintage<br>Wild Laredo<br>Yukon | 40<br>Elegance<br>Princess<br>Santiago<br>Sensation<br>Sunset<br>Trina<br>Victoria | 50<br>Bull<br>Cassiope<br>Dublin | 60<br>Caress<br>Ultrasued | A      | B<br>COM | C<br>alta |
| 001 CHAIR   | 29.5 x 35 x 31 | 1185    | 1235                  | 1285   | 1335   | 1385                             | 1435                      | 1050   | 1085     | 1120      |



## MADONNA

COMBO: Cover #2 on back and seat.

\*WARNING: It is recommended to use plain fabric with this style.

| Description             | L x D x H | Leather |                       |  |  |                                  |                           | Fabric |          |           |
|-------------------------|-----------|---------|-----------------------|--|--|----------------------------------|---------------------------|--------|----------|-----------|
|                         |           | 10      | 20<br>Madras<br>Softy | 30<br>Hugo<br>Fantasy<br>Illusion<br>Tucson<br>Utah<br>Vintage<br>Wild Laredo<br>Yukon | 40<br>Elegance<br>Princess<br>Santiago<br>Sensation<br>Sunset<br>Trina<br>Victoria | 50<br>Bull<br>Cassiope<br>Dublin | 60<br>Caress<br>Ultrasued | A      | B<br>COM | C<br>alta |
| 010 LOUNGE CHAIR        | 27X63X36  | 1420    | 1525                  | 1630   | 1735   | 1840                             | 1945                      | 1045   | 1115     | 1185      |
| 101 DOUBLE LOUNGE CHAIR | 39X63X36  | 1600    | 1720                  | 1840   | 1960   | 2080                             | 2200                      | 1175   | 1270     | 1365      |



## ODYSSEY

FEATURES: This swivel chair comes with a small back cushion.

Specifications:  
Seat Height: 17.25"  
Seat Depth: 23"  
Seat width: 23"  
Arm Height: 22.5"

OPTIONS:  
Combo price small back cushion:  
Chair in fabric / small back cushion in leather, add \$40. (Specify leather & colour)  
Chair in leather / small back cushion in fabric; no charge. (Specify fabric & colour)

Swivel Wood Base: Specify colour.

| Description      | L x D x H    | Leather |                       |  |  |                                  |                           | Fabric |          |           |
|------------------|--------------|---------|-----------------------|--|--|----------------------------------|---------------------------|--------|----------|-----------|
|                  |              | 10      | 20<br>Madras<br>Softy | 30<br>Hugo<br>Fantasy<br>Illusion<br>Tucson<br>Utah<br>Vintage<br>Wild Laredo<br>Yukon | 40<br>Elegance<br>Princess<br>Santiago<br>Sensation<br>Sunset<br>Trina<br>Victoria | 50<br>Bull<br>Cassiope<br>Dublin | 60<br>Caress<br>Ultrasued | A      | B<br>COM | C<br>alta |
| 015 SWIVEL CHAIR | 31 x 31 x 28 | 1300    | 1350                  | 1400   | 1450   | 1500                             | 1550                      | 900    | 935      | 970       |

## ALEXANDRA

**FEATURES:**

- Manual adjustable headrest on all items (2 on square corner & stationary on wedge).
- \*Wall hugger power recliners with full footrest (manual n/a).
- Power recliner lounge chair (manual n/a) with power headrest in option. Wall clearance 8" & front 5".
- Seat cushions with shaped foam + 1" layer of memory foam on top; arm with memory foam.
- Stitching: Small thread in fabric & large flat thread in leather.

\*Excludes 043 & 163 chairs: Wall clearance 16"

Chairs 043 & 163: arms with NO METAL insert.

Note: 2 recliner seats separated by a corner can not be opened at the same time. No recliner seats beside #155 Small Square Corner.

**OPTIONS**

Battery Pack: Add \$160/ea.

\*Motorized headrest: Add \$160 ea. (\*N/A on stationary items).

Foam: Extra firm add \$15/seat.

Choice of arms: (Large or the Small 6" Arm which will have no metal insert in arm): Leg on LARGE arm: LG103 wood, Metal: LG189 cyl. (Black or Chrome). SMALL Arm: LG08 wood, Metal: LG196 cyl. (Black or Chrome) or LG64 (sq). Specify colour.

Seat Depth: 20" or \*22". \*22" seat depth N/A on chairs 043 & 163.

043 & 163 Chairs: with wood base (specify colour).

**HOME THEATRE Configurations**

For Accessories, Cup holders & Configuration details, see Optima Home Theatre page attached.

Accessory Dock : \$35 ea.

Cup Holders: Metal: \$25 ea. | LED lighted Cup Holder: \$25 ea. | \*LED lighted Cup Holder with (1 or 2 motor) controls: \$40 ea.

\*LED Light strip under seat: \$25/seat.

| Description                        | L x D x H   | Leather |                       |  |  |                                  |                           | Fabric |          |           |
|------------------------------------|-------------|---------|-----------------------|--|--|----------------------------------|---------------------------|--------|----------|-----------|
|                                    |             | 10      | 20<br>Madras<br>Softy | 30<br>Hugo<br>Fantasy<br>Illusion<br>Tucson<br>Utah<br>Vintage<br>Wild Laredo<br>Yukon | 40<br>Elegance<br>Princess<br>Santiago<br>Sensation<br>Sunset<br>Trina<br>Victoria | 50<br>Bull<br>Cassiope<br>Dublin | 60<br>Caress<br>Ultrasued | A      | B<br>COM | C<br>alta |
| 001 CHAIR                          | 44x40x33/40 | 1890    | 1980                  | 2070   | 2160   | 2250                             | 2340                      | 1535   | 1580     | 1625      |
| 002 LOVESEAT                       | 67x40x33/40 | 2700    | 2815                  | 2930   | 3045   | 3160                             | 3275                      | 2175   | 2250     | 2325      |
| 003 SOFA                           | 91x40x33/40 | 3265    | 3415                  | 3565   | 3715   | 3865                             | 4015                      | 2625   | 2715     | 2805      |
| 005 LOUNGE CHAIR RIGHT ARM         | 34x62x33/40 | 1765    | 1830                  | 1895   | 1960   | 2025                             | 2090                      | 1410   | 1470     | 1530      |
| 009 ARMLESS LOVESEAT               | 47x40x33/40 | 1895    | 1965                  | 2035   | 2105   | 2175                             | 2245                      | 1490   | 1570     | 1650      |
| 011 LOUNGE CHAIR LEFT ARM          | 34x62x33/40 | 1765    | 1830                  | 1895   | 1960   | 2025                             | 2090                      | 1410   | 1470     | 1530      |
| 012 LOVESEAT LEFT ARM              | 57x40x33/40 | 2320    | 2420                  | 2520   | 2620   | 2720                             | 2820                      | 1850   | 1925     | 2000      |
| 017 DOUBLE CHAIR                   | 51x40x33/40 | 1980    | 2080                  | 2180   | 2280   | 2380                             | 2480                      | 1600   | 1660     | 1720      |
| 021 APARTMENT SOFA NO ARM          | 61x40x33/40 | 2140    | 2240                  | 2340   | 2440   | 2540                             | 2640                      | 1670   | 1755     | 1840      |
| 040 ARMLESS SOFA                   | 71x40x33/40 | 2450    | 2565                  | 2680   | 2795   | 2910                             | 3025                      | 1950   | 2040     | 2130      |
| 041 RECLINING CHAIR LEFT ARM       | 34x40x33/40 | 1885    | 1960                  | 2035   | 2110   | 2185                             | 2260                      | 1605   | 1640     | 1675      |
| 042 RECLINING CHAIR RIGHT ARM      | 34x40x33/40 | 1885    | 1960                  | 2035   | 2110   | 2185                             | 2260                      | 1605   | 1640     | 1675      |
| 043 SWIVEL ROCKING RECLINING CHAIR | 30x34x42    | 2235    | 2345                  | 2455   | 2565   | 2675                             | 2785                      | 1875   | 1920     | 1965      |
| 044 RECLINER CHAIR                 | 44x40x33/40 | 2275    | 2365                  | 2455   | 2545   | 2635                             | 2725                      | 1920   | 1970     | 2020      |
| 045 ARMLESS LOVESEAT BUMPER RIGHT  | 68x40x33/40 | 2245    | 2340                  | 2435   | 2530   | 2625                             | 2720                      | 1785   | 1850     | 1915      |

## ALEXANDRA

**FEATURES:**

- Manual adjustable headrest on all items (2 on square corner & stationary on wedge).
- \*Wall hugger power recliners with full footrest (manual n/a).
- Power recliner lounge chair (manual n/a) with power headrest in option. Wall clearance 8" & front 5".
- Seat cushions with shaped foam + 1" layer of memory foam on top; arm with memory foam.
- Stitching: Small thread in fabric & large flat thread in leather.

\*Excludes 043 & 163 chairs: Wall clearance 16"

Chairs 043 & 163: arms with NO METAL insert.

Note: 2 recliner seats separated by a corner can not be opened at the same time. No recliner seats beside #155 Small Square Corner.

**OPTIONS**

Battery Pack: Add \$160/ea.

\*Motorized headrest: Add \$160 ea. (\*N/A on stationary items).

Foam: Extra firm add \$15/seat.

Choice of arms: (Large or the Small 6" Arm which will have no metal insert in arm): Leg on LARGE arm: LG103 wood, Metal: LG189 cyl. (Black or Chrome). SMALL Arm: LG08 wood, Metal: LG196 cyl. (Black or Chrome) or LG64 (sq). Specify colour.

Seat Depth: 20" or \*22". \*22" seat depth N/A on chairs 043 & 163.

043 & 163 Chairs: with wood base (specify colour).

**HOME THEATRE Configurations**

For Accessories, Cup holders & Configuration details, see Optima Home Theatre page attached.

Accessory Dock : \$35 ea.

Cup Holders: Metal: \$25 ea. | LED lighted Cup Holder: \$25 ea. | \*LED lighted Cup Holder with (1 or 2 motor) controls: \$40 ea.

\*LED Light strip under seat: \$25/seat.

| Description                      | L x D x H     | Leather |                       |  |  |                                  |                           | Fabric |          |           |
|----------------------------------|---------------|---------|-----------------------|--|--|----------------------------------|---------------------------|--------|----------|-----------|
|                                  |               | 10      | 20<br>Madras<br>Softy | 30<br>Hugo<br>Fantasy<br>Illusion<br>Tucson<br>Utah<br>Vintage<br>Wild Laredo<br>Yukon | 40<br>Elegance<br>Princess<br>Santiago<br>Sensation<br>Sunset<br>Trina<br>Victoria | 50<br>Bull<br>Cassiope<br>Dublin | 60<br>Caress<br>Ultrasued | A      | B<br>COM | C<br>alta |
| 050 WEDGE                        | 49x49x33      | 1645    | 1745                  | 1845   | 1945   | 2045                             | 2145                      | 1210   | 1270     | 1330      |
| 051 ARMLESS CHAIR                | 23,5x40x33/40 | 1085    | 1135                  | 1185   | 1235   | 1285                             | 1335                      | 845    | 900      | 955       |
| 052 SOFA LEFT ARM                | 81x40x33/40   | 2870    | 3005                  | 3140   | 3275   | 3410                             | 3545                      | 2290   | 2385     | 2480      |
| 053 SOFA RIGHT ARM               | 81x40x33/40   | 2870    | 3005                  | 3140   | 3275   | 3410                             | 3545                      | 2290   | 2385     | 2480      |
| 055 SQUARE CORNER                | 44x44x33/40   | 1915    | 2010                  | 2105   | 2200   | 2295                             | 2390                      | 1510   | 1565     | 1620      |
| 056 CHAIR RIGHT ARM              | 34x40x33/40   | 1510    | 1575                  | 1640   | 1705   | 1770                             | 1835                      | 1200   | 1260     | 1320      |
| 057 CHAIR LEFT ARM               | 34x40x33/40   | 1510    | 1575                  | 1640   | 1705   | 1770                             | 1835                      | 1200   | 1260     | 1320      |
| 061 LOVESEAT RIGHT ARM           | 57x40x33/40   | 2320    | 2420                  | 2520   | 2620   | 2720                             | 2820                      | 1850   | 1925     | 2000      |
| 071 ARMLESS RECLINING CHAIR      | 23,5x40x33/40 | 1470    | 1525                  | 1580   | 1635   | 1690                             | 1745                      | 1250   | 1310     | 1370      |
| 086 ARMLESS LOVESEAT BUMPER LEFT | 68x40x33/40   | 2245    | 2340                  | 2435   | 2530   | 2625                             | 2720                      | 1785   | 1850     | 1915      |
| 088 ARMLESS CHAIR BUMPER LEFT    | 45x40x33/40   | 1440    | 1535                  | 1630   | 1725   | 1820                             | 1915                      | 1130   | 1165     | 1200      |
| 089 ARMLESS CHAIR BUMPER RIGHT   | 45x40x33/40   | 1440    | 1535                  | 1630   | 1725   | 1820                             | 1915                      | 1130   | 1165     | 1200      |
| 095 APARTMENT SOFA               | 81x40x33/40   | 2940    | 3085                  | 3230   | 3375   | 3520                             | 3665                      | 2350   | 2445     | 2540      |
| 096 APARTMENT SOFA LEFT ARM      | 71x40x33/40   | 2570    | 2680                  | 2790   | 2900   | 3010                             | 3120                      | 2020   | 2110     | 2200      |
| 097 APARTMENT SOFA RIGHT ARM     | 71x40x33/40   | 2570    | 2680                  | 2790   | 2900   | 3010                             | 3120                      | 2020   | 2110     | 2200      |
| 124 STORAGE OTTOMAN              | 30x22x17      | 745     | 765                   | 785  | 805  | 825                              | 845                       | 650    | 670      | 690       |

## ALEXANDRA

**FEATURES:**

- Manual adjustable headrest on all items (2 on square corner & stationary on wedge).
- \*Wall hugger power recliners with full footrest (manual n/a).
- Power recliner lounge chair (manual n/a) with power headrest in option. Wall clearance 8" & front 5".
- Seat cushions with shaped foam + 1" layer of memory foam on top; arm with memory foam.
- Stitching: Small thread in fabric & large flat thread in leather.

\*Excludes 043 & 163 chairs: Wall clearance 16"

Chairs 043 & 163: arms with NO METAL insert.

Note: 2 recliner seats separated by a corner can not be opened at the same time. No recliner seats beside #155 Small Square Corner.

**OPTIONS**

Battery Pack: Add \$160/ea.

\*Motorized headrest: Add \$160 ea. (\*N/A on stationary items).

Foam: Extra firm add \$15/seat.

Choice of arms: (Large or the Small 6" Arm which will have no metal insert in arm): Leg on LARGE arm: LG103 wood, Metal: LG189 cyl. (Black or Chrome). SMALL Arm: LG08 wood, Metal: LG196 cyl. (Black or Chrome) or LG64 (sq). Specify colour.

Seat Depth: 20" or \*22". \*22" seat depth N/A on chairs 043 & 163.

043 & 163 Chairs: with wood base (specify colour).

**HOME THEATRE Configurations**

For Accessories, Cup holders & Configuration details, see Optima Home Theatre page attached.

Accessory Dock : \$35 ea.

Cup Holders: Metal: \$25 ea. | LED lighted Cup Holder: \$25 ea. | \*LED lighted Cup Holder with (1 or 2 motor) controls: \$40 ea.

\*LED Light strip under seat: \$25/seat.

| Description                            | L x D x H     | Leather |                       |  |  |                                  |                           | Fabric |          |           |
|--|---------------|---------|-----------------------|--|--|----------------------------------|---------------------------|--------|----------|-----------|
|  |               | 10      | 20<br>Madras<br>Softy | 30<br>Hugo<br>Fantasy<br>Illusion<br>Tucson<br>Utah<br>Vintage<br>Wild Laredo<br>Yukon | 40<br>Elegance<br>Princess<br>Santiago<br>Sensation<br>Sunset<br>Trina<br>Victoria | 50<br>Bull<br>Cassiope<br>Dublin | 60<br>Caress<br>Ultrasued | A      | B<br>COM | C<br>alta |
| 138 STRAIGHT ARM                       | 10x36x24.5    | 415     | 450                   | 485  | 520  | 555                              | 590                       | 350    | 365      | 380       |
| 155 SMALL SQUARE CORNER                | 40x40x33/40   | 1915    | 2010                  | 2105   | 2200   | 2295                             | 2390                      | 1510   | 1565     | 1620      |
| 159 WEDGE STORAGE                      | 11/27x36x24.5 | 745     | 775                   | 805  | 835  | 865                              | 895                       | 585    | 600      | 615       |
| 160 STRAIGHT STORAGE                   | 11x36x24.5    | 720     | 745                   | 770  | 795  | 820                              | 845                       | 550    | 570      | 590       |
| 163 DBL SWIVEL ROCKING RECLINER CHAIR  | 33x34x42      | 2290    | 2410                  | 2530   | 2650   | 2770                             | 2890                      | 1880   | 1930     | 1980      |
| 165 DOUBLE RECLINING CHAIR             | 51x40x33/40   | 2375    | 2475                  | 2575   | 2675   | 2775                             | 2875                      | 2000   | 2065     | 2130      |
| 167 APARTMENT SOFA NO ARM BUMPER LEFT  | 82x40x33/40   | 2490    | 2620                  | 2750   | 2880   | 3010                             | 3140                      | 1960   | 2045     | 2130      |
| 168 APARTMENT SOFA NO ARM BUMPER RIGHT | 82x40x33/40   | 2490    | 2620                  | 2750   | 2880   | 3010                             | 3140                      | 1960   | 2045     | 2130      |
| 169 DOUBLE RECLINING CHAIR LEFT ARM    | 41x40x33/40   | 1990    | 2070                  | 2150   | 2230   | 2310                             | 2390                      | 1670   | 1750     | 1830      |
| 170 DOUBLE RECLINING CHAIR RIGHT ARM   | 41x40x33/40   | 1990    | 2070                  | 2150   | 2230   | 2310                             | 2390                      | 1670   | 1750     | 1830      |
| 171 ARMLESS DOUBLE RECLINING CHAIR     | 30,5x40x33/40 | 1575    | 1625                  | 1675   | 1725   | 1775                             | 1825                      | 1320   | 1380     | 1440      |
| 173 DOUBLE LOUNGE CHAIR LEFT ARM       | 41x62x33/40   | 1915    | 2005                  | 2095   | 2185   | 2275                             | 2365                      | 1535   | 1615     | 1695      |
| 174 DOUBLE LOUNGE CHAIR RIGHT ARM      | 41x62x33/40   | 1915    | 2005                  | 2095   | 2185   | 2275                             | 2365                      | 1535   | 1615     | 1695      |
| 175 DOUBLE CHAIR LEFT ARM              | 41x40x33/40   | 1590    | 1680                  | 1770   | 1860   | 1950                             | 2040                      | 1285   | 1350     | 1415      |
| 176 DOUBLE CHAIR RIGHT ARM             | 41x40x33/40   | 1590    | 1680                  | 1770   | 1860   | 1950                             | 2040                      | 1285   | 1350     | 1415      |
| 177 ARMLESS DOUBLE CHAIR               | 30,5x40x33/40 | 1185    | 1250                  | 1315   | 1380   | 1445                             | 1510                      | 915    | 970      | 1025      |

## ALEXANDRA

**FEATURES:**

- Manual adjustable headrest on all items (2 on square corner & stationary on wedge).
- \*Wall hugger power recliners with full footrest (manual n/a).
- Power recliner lounge chair (manual n/a) with power headrest in option. Wall clearance 8" & front 5".
- Seat cushions with shaped foam + 1" layer of memory foam on top; arm with memory foam.
- Stitching: Small thread in fabric & large flat thread in leather.

\*Excludes 043 & 163 chairs: Wall clearance 16"

Chairs 043 & 163: arms with NO METAL insert.

Note: 2 recliner seats separated by a corner can not be opened at the same time. No recliner seats beside #155 Small Square Corner.

**OPTIONS**

Battery Pack: Add \$160/ea.

\*Motorized headrest: Add \$160 ea. (\*N/A on stationary items).

Foam: Extra firm add \$15/seat.

Choice of arms: (Large or the Small 6" Arm which will have no metal insert in arm): Leg on LARGE arm: LG103 wood, Metal: LG189 cyl. (Black or Chrome). SMALL Arm: LG08 wood, Metal: LG196 cyl. (Black or Chrome) or LG64 (sq). Specify colour.

Seat Depth: 20" or \*22". \*22" seat depth N/A on chairs 043 & 163.

043 & 163 Chairs: with wood base (specify colour).

**HOME THEATRE Configurations**

For Accessories, Cup holders & Configuration details, see Optima Home Theatre page attached.

Accessory Dock : \$35 ea.

Cup Holders: Metal: \$25 ea. | LED lighted Cup Holder: \$25 ea. | \*LED lighted Cup Holder with (1 or 2 motor) controls: \$40 ea.

\*LED Light strip under seat: \$25/seat.

| Description                            | L x D x H       | Leather |                       |  |  |                                  |                           | Fabric |          |           |
|--|-----------------|---------|-----------------------|--|--|----------------------------------|---------------------------|--------|----------|-----------|
|  |                 | 10      | 20<br>Madras<br>Softy | 30<br>Hugo<br>Fantasy<br>Illusion<br>Tucson<br>Utah<br>Vintage<br>Wild Laredo<br>Yukon | 40<br>Elegance<br>Princess<br>Santiago<br>Sensation<br>Sunset<br>Trina<br>Victoria | 50<br>Bull<br>Cassiope<br>Dublin | 60<br>Caress<br>Ultrasued | A      | B<br>COM | C<br>alta |
| 178 ARMLESS DOUBLE CHAIR BUMPER LEFT   | 52x40x33/40     | 1545    | 1625                  | 1705   | 1785   | 1865                             | 1945                      | 1230   | 1290     | 1350      |
| 179 ARMLESS DOUBLE CHAIR BUMPER RIGHT  | 52x40x33/40     | 1545    | 1625                  | 1705   | 1785   | 1865                             | 1945                      | 1230   | 1290     | 1350      |
| 186 ARMLESS LOVESEAT BUMPER STORAGE-L  | 68x40x33/40     | 2420    | 2500                  | 2580   | 2660   | 2740                             | 2820                      | 1950   | 2015     | 2080      |
| 187 ARMLESS LOVESEAT BUMPER STORAGE-R  | 68x40x33/40     | 2420    | 2500                  | 2580   | 2660   | 2740                             | 2820                      | 1950   | 2015     | 2080      |
| 188 ARMLESS CHAIR BUMPER STORAGE-L     | 45x40x33/40     | 1600    | 1690                  | 1780   | 1870   | 1960                             | 2050                      | 1295   | 1330     | 1365      |
| 189 ARMLESS CHAIR BUMPER STORAGE-R     | 45x40x33/40     | 1600    | 1690                  | 1780   | 1870   | 1960                             | 2050                      | 1295   | 1330     | 1365      |
| 190 SMALL WEDGE STORAGE                | 11/21x36x24.5   | 720     | 745                   | 770  | 795  | 820                              | 845                       | 550    | 570      | 590       |
| 221 ARMLESS DBL CHAIR BUMPER STORAGE-L | 52x40x33/40     | 1705    | 1790                  | 1875   | 1960   | 2045                             | 2130                      | 1390   | 1450     | 1510      |
| 222 ARMLESS DBL CHAIR BUMPER STORAGE-R | 52x40x33/40     | 1705    | 1790                  | 1875   | 1960   | 2045                             | 2130                      | 1390   | 1450     | 1510      |
| 223 APT SOFA NO ARM BUMPER STORAGE-L   | 82x40x33/40     | 2655    | 2785                  | 2915   | 3045   | 3175                             | 3305                      | 2120   | 2215     | 2310      |
| 224 APT SOFA NO ARM BUMPER STORAGE-R   | 82x40x33/40     | 2655    | 2785                  | 2915   | 3045   | 3175                             | 3305                      | 2120   | 2215     | 2310      |
| 236 RECLINING LOUNGE CHAIR LEFT ARM    | 34x62x33/40     | 2160    | 2225                  | 2290   | 2355   | 2420                             | 2485                      | 1820   | 1880     | 1940      |
| 237 RECLINING LOUNGE CHAIR RIGHT ARM   | 34x62x33/40     | 2160    | 2225                  | 2290   | 2355   | 2420                             | 2485                      | 1820   | 1880     | 1940      |
| 238 RECLINING DBL LOUNGE CHAIR L-ARM   | 41x62x33/40     | 2315    | 2405                  | 2495   | 2585   | 2675                             | 2765                      | 1940   | 2020     | 2100      |
| 239 RECLINING DBL LOUNGE CHAIR R-ARM   | 41x62x33/40     | 2315    | 2405                  | 2495   | 2585   | 2675                             | 2765                      | 1940   | 2020     | 2100      |
| V51 WINE GLASS HOLDER                  | 3.5 x 5.5 x 6.5 | 35      | 35                    | 35   | 35   | 35                               | 35                        | 35     | 35       | 35        |

## ALEXANDRA

**FEATURES:**

- Manual adjustable headrest on all items (2 on square corner & stationary on wedge).
- \*Wall hugger power recliners with full footrest (manual n/a).
- Power recliner lounge chair (manual n/a) with power headrest in option. Wall clearance 8" & front 5".
- Seat cushions with shaped foam + 1" layer of memory foam on top; arm with memory foam.
- Stitching: Small thread in fabric & large flat thread in leather.

\*Excludes 043 & 163 chairs: Wall clearance 16"

Chairs 043 & 163: arms with NO METAL insert.

Note: 2 recliner seats separated by a corner can not be opened at the same time. No recliner seats beside #155 Small Square Corner.

**OPTIONS**

Battery Pack: Add \$160/ea.

\*Motorized headrest: Add \$160 ea. (\*N/A on stationary items).

Foam: Extra firm add \$15/seat.

Choice of arms: (Large or the Small 6" Arm which will have no metal insert in arm): Leg on LARGE arm: LG103 wood, Metal: LG189 cyl. (Black or Chrome). SMALL Arm: LG08 wood, Metal: LG196 cyl. (Black or Chrome) or LG64 (sq). Specify colour.

Seat Depth: 20" or \*22". \*22" seat depth N/A on chairs 043 & 163.

043 & 163 Chairs: with wood base (specify colour).

**HOME THEATRE Configurations**

For Accessories, Cup holders & Configuration details, see Optima Home Theatre page attached.

Accessory Dock : \$35 ea.

Cup Holders: Metal: \$25 ea. | LED lighted Cup Holder: \$25 ea. | \*LED lighted Cup Holder with (1 or 2 motor) controls: \$40 ea.

\*LED Light strip under seat: \$25/seat.

| Description                 | L x D x H          | Leather |                       |  |  |                                  |                           | Fabric |          |           |
|-----------------------------|--------------------|---------|-----------------------|--|--|----------------------------------|---------------------------|--------|----------|-----------|
|                             |                    | 10      | 20<br>Madras<br>Softy | 30<br>Hugo<br>Fantasy<br>Illusion<br>Tucson<br>Utah<br>Vintage<br>Wild Laredo<br>Yukon | 40<br>Elegance<br>Princess<br>Santiago<br>Sensation<br>Sunset<br>Trina<br>Victoria | 50<br>Bull<br>Cassiope<br>Dublin | 60<br>Caress<br>Ultrasued | A      | B<br>COM | C<br>alta |
| V52 PLASTIC SWIVEL TRAY     | 13 3/8 x 9 5/8     | 35      | 35                    | 35   | 35   | 35                               | 35                        | 35     | 35       | 35        |
| V53 WOOD SWIVEL TRAY        | 19 x 10            | 60      | 60                    | 60   | 60   | 60                               | 60                        | 60     | 60       | 60        |
| V54 TABLET HOLDER           | 4.5 x 8 x 10       | 40      | 40                    | 40   | 40   | 40                               | 40                        | 40     | 40       | 40        |
| V55 LED LAMP                | 1.5x5x14 plié/bent | 35      | 35                    | 35   | 35   | 35                               | 35                        | 35     | 35       | 35        |
| <b>CONFIGURATIONS</b>       |                    |         |                       |  |  |                                  |                           |        |          |           |
| _A CONFIG (169-170)         | 82X40X40           | 3980    | 4140                  | 4300   | 4460   | 4620                             | 4780                      | 3340   | 3500     | 3660      |
| _B CONFIG (169-171-174)     | 113X62X40          | 5480    | 5700                  | 5920   | 6140   | 6360                             | 6580                      | 4525   | 4745     | 4965      |
| _C CONFIG (096-055-171-170) | 115X115X40         | 8050    | 8385                  | 8720   | 9055   | 9390                             | 9725                      | 6520   | 6805     | 7090      |
| _D CONFIG (169-171-055-179) | 115X96X40          | 7025    | 7330                  | 7635   | 7940   | 8245                             | 8550                      | 5730   | 5985     | 6240      |
| _J CONFIG (041-042)         | 68X40X40           | 3770    | 3920                  | 4070   | 4220   | 4370                             | 4520                      | 3210   | 3280     | 3350      |
| _K CONFIG (041-071-005)     | 92X62X40           | 5120    | 5315                  | 5510   | 5705   | 5900                             | 6095                      | 4265   | 4420     | 4575      |
| _L CONFIG (012-055-071-042) | 102X102X40         | 7590    | 7915                  | 8240   | 8565   | 8890                             | 9215                      | 6215   | 6440     | 6665      |
| _M CONFIG (041-071-055-089) | 102X89X40          | 6710    | 7030                  | 7350   | 7670   | 7990                             | 8310                      | 5495   | 5680     | 5865      |





# ALEXANDRA

**OPTIMA**  
Collection

**Jaymar**

Conçu et fabriqué fièrement au Canada  
Proudly designed and made in Canada

Nos produits sont fabriqués à la main et des variations mineures peuvent survenir

Our product is hand-made and minor variations can occur.

## SPECIFICATIONS

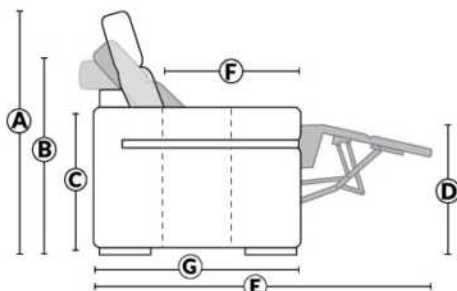

- Appui-tête levé Headrest up
- Appui-tête baissé Headrest down
- Complètement incliné Fully reclined

- A** Hauteur complète 40" Total Height
- B** Hauteur appui-tête baissé 33" Height headrest down
- C** Hauteur du bras 24,5" Arm Height
- D** Hauteur du siège 19,5" Seat height
- E** Profondeur inclinée 65" Depth fully reclined
- F** Profondeur d'assise 20"ou/ou 22" Seat depth
- G** Profondeur appui-tête monté 37,5" Depth with headrest up

## BRAS | ARMS

Option de bras:  
Bras Régulier Large 10" ou Petit bras 6"

Arm option  
Regular arm Large 10" or Small arm 6"

Contrôle de l'inclinaison situé à l'intérieur du bras  
Recliner control located on the inside of the arm.

Option d'accessoires disponible sur le bras régulier seulement  
Accessories option, available on Regular arms ONLY.

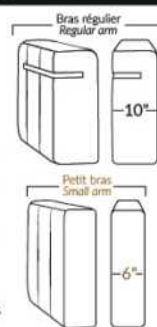

## FAUTEUIL BERÇANT PIVOTANT INCLINABLE SWIVEL ROCKING MOTION CHAIR

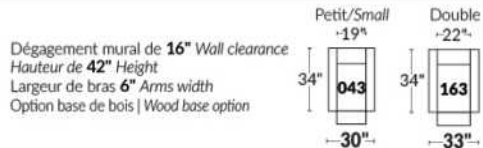

## SIÈGE 23" DE LARGE | 23" SEAT WIDTH

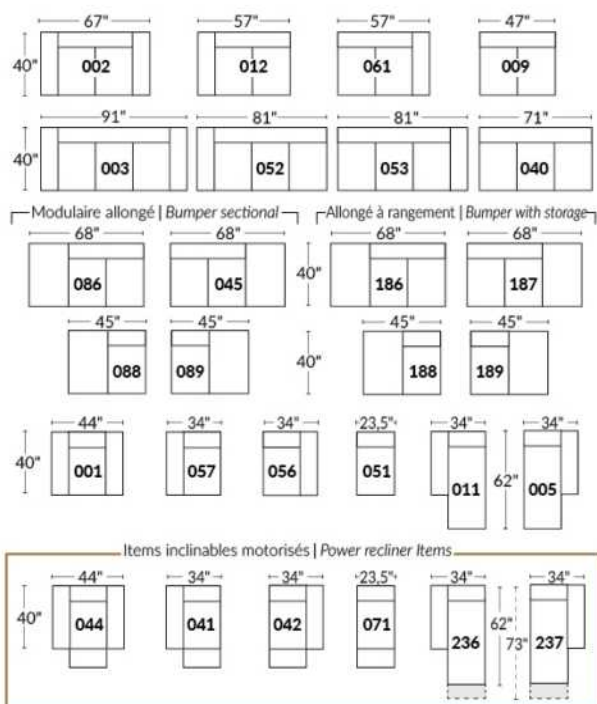

## SIÈGE 30" DE LARGE | 30" SEAT WIDTH

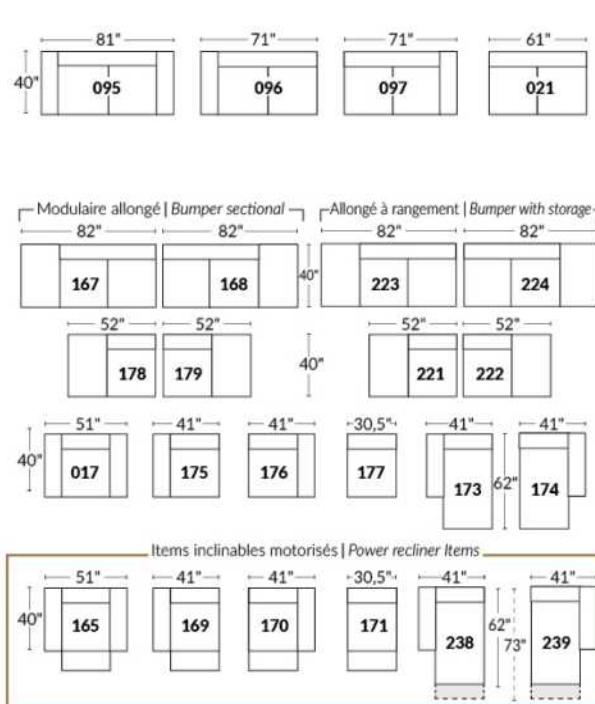

### Autres | Others

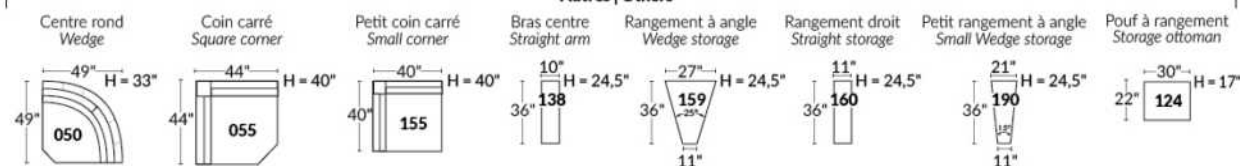

### EXEMPLE 23" EXAMPLE

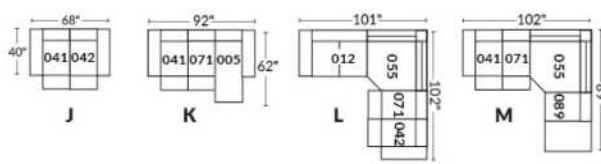

### EXEMPLE 30" EXAMPLE

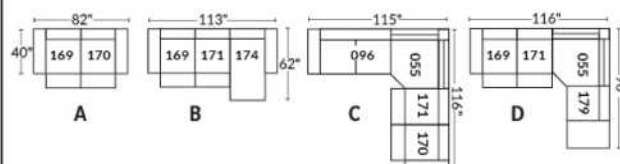

\*Available on certain models and on large arms ONLY.

### OPTIONS CUP HOLDERS

#### METAL



Silver



Matte Black



Brown

#### ILLUMINATED

1.



LED Lighted Cup holder

2.



LED Lighted Cup holder with Single Motor Control, USB Port and LED Base rail

3.



LED Lighted Cup holder with Dual Motor Control, USB Port and LED Base rail

Our illuminated one or two-control cup holders are compatible with LED lights under the seat. You can control the light on the cup holder. The 2 motor cup holder has a reset (home) button control to close your recliner back to its starting position.

#### LED Light under seat (Optional)

Available only in configurations with a minimum of 1 illuminated motorized cup holder with control buttons. The "light" button will control the opening and closing of the light.

For cup holder prices see description section of the Optima model price list.

Please provide us with a drawing of your configuration which indicates the cup holder type and its positioning.

#### Cup holder with controller:

It is important to specify the placement of the cups; on left arm or right arm and which recliner they will control. If you have a row of several seats with cup holders, by default, the controls will be on the left arms and on the right arm for the last outer chair.

#### EXAMPLE A:

041-169: Controller and cup holder on the left arm

071-171: hidden touch sensor buttons on side of seat

042-170: Controller and cup holder on right arm



#### EXAMPLE B:

071-171: These two items can be connected to a smart cup holder which will control the recliner. You must then use one of these items: 138,159, 160 and 190



#### Informations about headrest, controller on reclining seat

#### WITH illuminated cup holder

If you have a **stationary item**, you will have cup holder N°1.

If you have a recliner chair with a **manual headrest**, you will have the cup holder N°2.

If you have a recliner chair with an **electric headrest**, you will have cup holder N°3.

#### Without cup holder and with a reclining seat

If you have a recliner with a **manual headrest** you will have the touch sensor button control on the side of the seat.

If you have a recliner with an **electric headrest** you will have a dual push button controller with USB port on the arm.

If you have an **armless recliner**, you will have the hidden touch sensor button control.



Hidden touch sensor



Dual push button

# OPTIMA

## HOME THEATRE Configurations

\*Available on certain models and on large arms ONLY.

OPTIONS

### ACCESSORIES

Accessory Dock



V51 Wine Glass Holder



V52 Plastic Swivel Tray Table



V53 Wood Swivel tray Table  
(Choice of 8 colors)



Specify on which arm (left or right) the tray table will be installed.

V54 Tablet Holder



V55 LED Lamp



(For Accessory Dock price, see description section of the Optima model price list and for Accessory item prices, see at very end of the price list)

#### Items 138-159-160-190 and large arm.

Accessory docks and cups are Optional. \*Not available on small arms\*

Please specify on which arms you want the accessory docks and cup holders.

NB: Item 138-159-160-190 are unfinished on the sides, must be used between 2 seats.

Each storage item has 2 USB ports and one electrical outlet inside the storage.



#### SUGGESTED CONFIGURATIONS

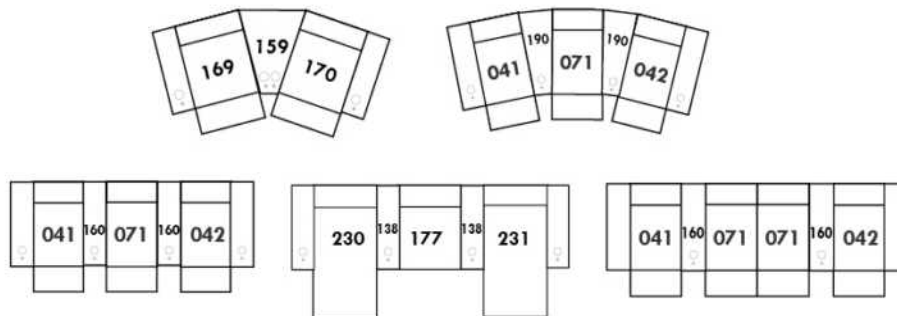

## CDN Price List

### ALLEGRO

LEG: Specify colour of legs LG4.

COMBO: Cover #2 on back only. PLAIN fabric recommended.

| Description                         | L x D x H    | Leather |                       |  |  |                                  |                           | Fabric |          |           |
|-------------------------------------|--------------|---------|-----------------------|--|--|----------------------------------|---------------------------|--------|----------|-----------|
|                                     |              | 10      | 20<br>Madras<br>Softy | 30<br>Hugo<br>Fantasy<br>Illusion<br>Tucson<br>Utah<br>Vintage<br>Wild Laredo<br>Yukon | 40<br>Elegance<br>Princess<br>Santiago<br>Sensation<br>Sunset<br>Trina<br>Victoria | 50<br>Bull<br>Cassiope<br>Dublin | 60<br>Caress<br>Ultrasued | A      | B<br>COM | C<br>alta |
| 001 CHAIR                           | 41X36X34     | 1405    | 1495                  | 1585   | 1675   | 1765                             | 1855                      | 1040   | 1095     | 1150      |
| 002 LOVESEAT                        | 64X36X34     | 1875    | 1995                  | 2115   | 2235   | 2355                             | 2475                      | 1360   | 1435     | 1510      |
| 003 SOFA                            | 87X36X34     | 2180    | 2335                  | 2490   | 2645   | 2800                             | 2955                      | 1635   | 1735     | 1835      |
| 005 LOUNGE CHAIR RIGHT ARM          | 32X60X34     | 1630    | 1750                  | 1870   | 1990   | 2110                             | 2230                      | 1130   | 1195     | 1260      |
| 006 OTTOMAN                         | 25.5X25.5X18 | 620     | 680                   | 740  | 800  | 860                              | 920                       | 535    | 545      | 555       |
| 009 ARMLESS LOVESEAT                | 46X36X34     | 1560    | 1675                  | 1790   | 1905   | 2020                             | 2135                      | 1155   | 1240     | 1325      |
| 011 LOUNGE CHAIR LEFT ARM           | 32X60X34     | 1630    | 1750                  | 1870   | 1990   | 2110                             | 2230                      | 1130   | 1195     | 1260      |
| 012 LOVESEAT LEFT ARM               | 55X36X34     | 1650    | 1780                  | 1910   | 2040   | 2170                             | 2300                      | 1255   | 1330     | 1405      |
| 024 SECTIONAL LOVESEAT BUMPER RIGHT | 79X36X34     | 1735    | 1840                  | 1945   | 2050   | 2155                             | 2260                      | 1325   | 1385     | 1445      |
| 048 SECTIONAL LOVESEAT BUMPER LEFT  | 79X36X34     | 1735    | 1840                  | 1945   | 2050   | 2155                             | 2260                      | 1325   | 1385     | 1445      |
| 050 WEDGE                           | 48X48X34     | 1390    | 1495                  | 1600   | 1705   | 1810                             | 1915                      | 1130   | 1175     | 1220      |
| 052 SOFA LEFT ARM                   | 78X36X34     | 1980    | 2130                  | 2280   | 2430   | 2580                             | 2730                      | 1535   | 1620     | 1705      |
| 053 SOFA RIGHT ARM                  | 78X36X34     | 1980    | 2130                  | 2280   | 2430   | 2580                             | 2730                      | 1535   | 1620     | 1705      |
| 055 SQUARE CORNER                   | 35X35X34     | 1345    | 1450                  | 1555   | 1660   | 1765                             | 1870                      | 1040   | 1100     | 1160      |
| 056 CHAIR RIGHT ARM                 | 32X36X34     | 1260    | 1330                  | 1400   | 1470   | 1540                             | 1610                      | 950    | 1000     | 1050      |
| 057 CHAIR LEFT ARM                  | 32X36X34     | 1260    | 1330                  | 1400   | 1470   | 1540                             | 1610                      | 950    | 1000     | 1050      |
| 061 LOVESEAT RIGHT ARM              | 55X36X34     | 1650    | 1780                  | 1910   | 2040   | 2170                             | 2300                      | 1255   | 1330     | 1405      |
| 095 APARTMENT SOFA                  | 79X36X34     | 2070    | 2205                  | 2340   | 2475   | 2610                             | 2745                      | 1575   | 1650     | 1725      |
| <b>CONFIGURATIONS</b>               |              |         |                       |  |  |                                  |                           |        |          |           |
| A CONF. A (052-005)                 | 110X60X34    | 3610    | 3880                  | 4150   | 4420   | 4690                             | 4960                      | 2665   | 2815     | 2965      |
| B CONF. B (048-053)                 | 114X79X34    | 3715    | 3970                  | 4225   | 4480   | 4735                             | 4990                      | 2860   | 3005     | 3150      |
| C CONF. C (012-050-061)             | 103X103X34   | 4690    | 5055                  | 5420   | 5785   | 6150                             | 6515                      | 3640   | 3835     | 4030      |
| D CONF. D (011-009-024)             | 114X79X34    | 4925    | 5265                  | 5605   | 5945   | 6285                             | 6625                      | 3610   | 3820     | 4030      |
| E CONF. E (057-024)                 | 79X68X34     | 2995    | 3170                  | 3345   | 3520   | 3695                             | 3870                      | 2275   | 2385     | 2495      |
| F CONF. F (003-001-006)             | 87X36X34     | 4205    | 4510                  | 4815   | 5120   | 5425                             | 5730                      | 3210   | 3375     | 3540      |

# ALLEGRO



Hauteur complète 34" | Hauteur de siège 18" | Hauteur devant bras 24" | Profondeur d'assise 21"  
 Total Height 34" | Seat Height 18" | Arm Height 24" | Seat Depth 21"

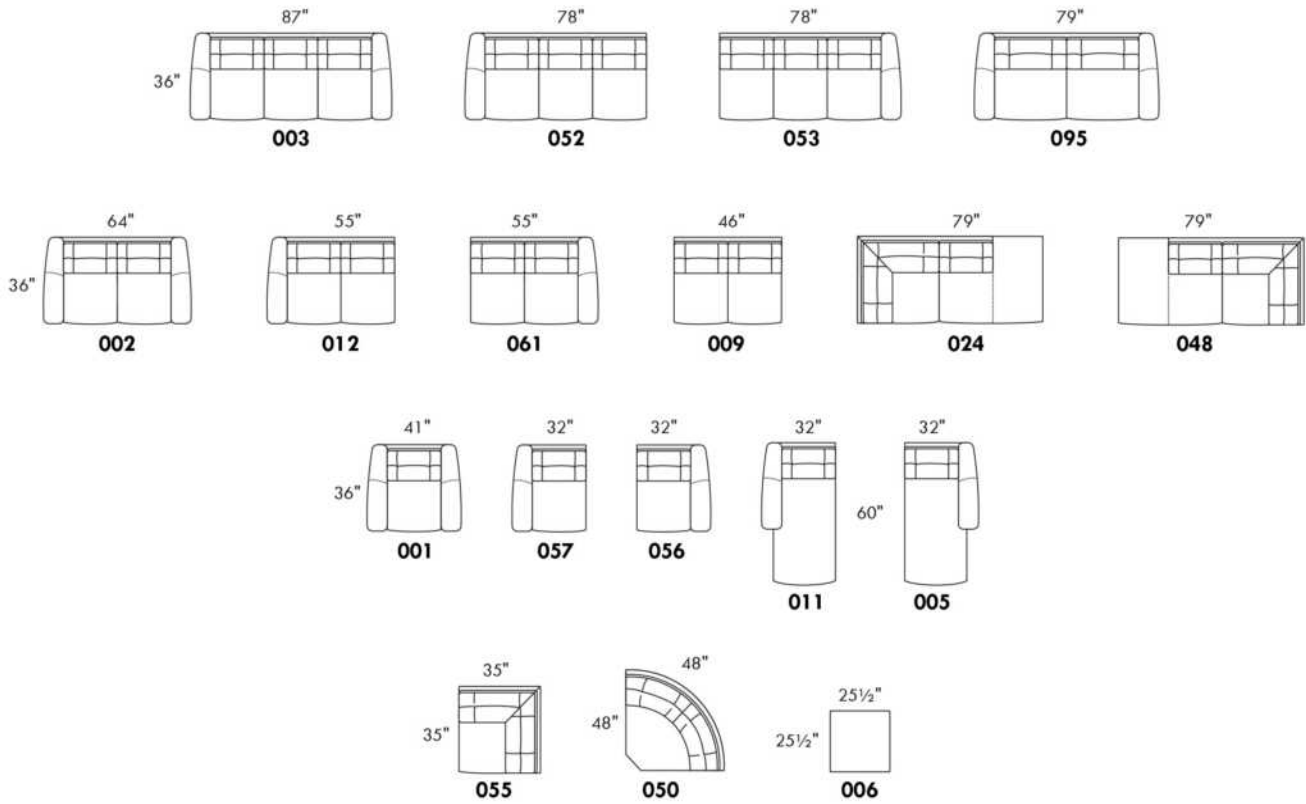

## CONFIGURATIONS

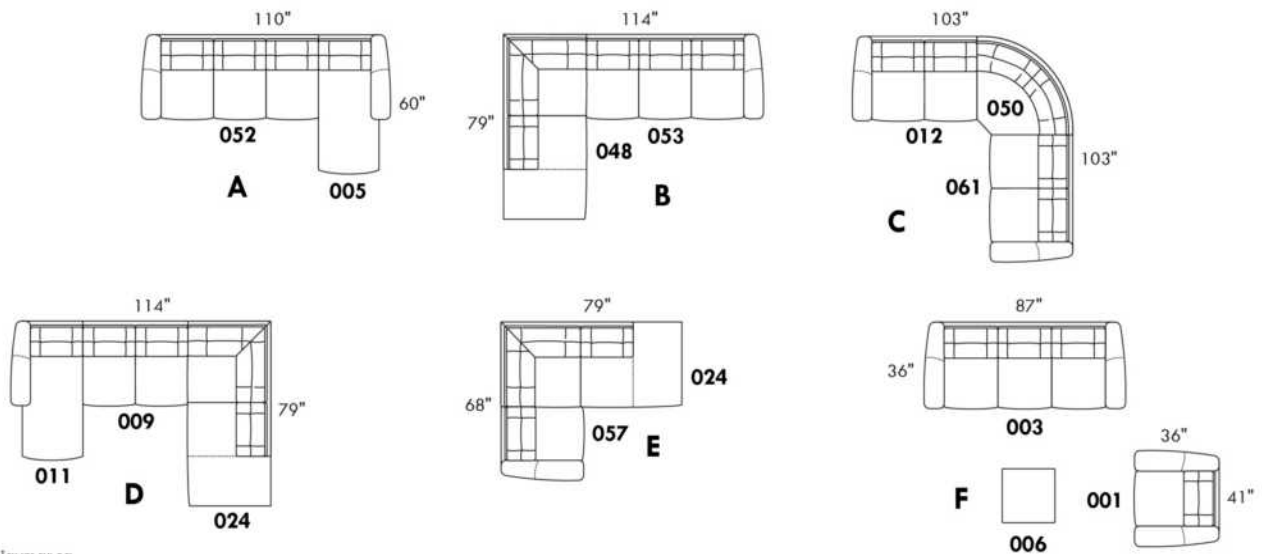

www.jaymar.ca

Toutes les dimensions indiquées sont au pouce près. Nos produits sont fabriqués à la main et des variations mineures peuvent survenir.  
 All dimensions indicated are to the nearest inch. Our product is hand-made and minor variations can occur.



## CDN Price List

### ALVARO

Specify colour of legs LG35.

COMBO: Cover #2 on back only.  
Plain fabric recommended for the base.

\*REMARK: In leather and fabric, armless end pieces and wedge are not fully upholstered.

| Description                         | L x D x H    | Leather |                       |  |  |                                  |                           | Fabric |          |           |
|-------------------------------------|--------------|---------|-----------------------|--|--|----------------------------------|---------------------------|--------|----------|-----------|
|                                     |              | 10      | 20<br>Madras<br>Softy | 30<br>Hugo<br>Fantasy<br>Illusion<br>Tucson<br>Utah<br>Vintage<br>Wild Laredo<br>Yukon | 40<br>Elegance<br>Princess<br>Santiago<br>Sensation<br>Sunset<br>Trina<br>Victoria | 50<br>Bull<br>Cassiope<br>Dublin | 60<br>Caress<br>Ultrasued | A      | B<br>COM | C<br>alta |
| 001 CHAIR                           | 40X38X34     | 1360    | 1455                  | 1550   | 1645   | 1740                             | 1835                      | 975    | 1035     | 1095      |
| 002 LOVESEAT                        | 63X38X34     | 1980    | 2085                  | 2190   | 2295   | 2400                             | 2505                      | 1305   | 1360     | 1415      |
| 003 SOFA                            | 86X38X34     | 2450    | 2610                  | 2770   | 2930   | 3090                             | 3250                      | 1685   | 1785     | 1885      |
| 005 LOUNGE CHAIR RIGHT ARM          | 32X67X34     | 1360    | 1455                  | 1550   | 1645   | 1740                             | 1835                      | 1040   | 1100     | 1160      |
| 006 OTTOMAN                         | 25.5X25.5X18 | 660     | 690                   | 720  | 750  | 780                              | 810                       | 505    | 525      | 545       |
| 011 LOUNGE CHAIR LEFT ARM           | 32X67X34     | 1360    | 1455                  | 1550   | 1645   | 1740                             | 1835                      | 1040   | 1100     | 1160      |
| 012 LOVESEAT LEFT ARM               | 55X38X34     | 1700    | 1820                  | 1940   | 2060   | 2180                             | 2300                      | 1180   | 1270     | 1360      |
| 024 SECTIONAL LOVESEAT BUMPER RIGHT | 80X38X34     | 2040    | 2155                  | 2270   | 2385   | 2500                             | 2615                      | 1395   | 1475     | 1555      |
| 045 ARMLESS LOVESEAT BUMPER RIGHT   | 67X38X34     | 1700    | 1820                  | 1940   | 2060   | 2180                             | 2300                      | 1180   | 1270     | 1360      |
| 048 SECTIONAL LOVESEAT BUMPER LEFT  | 80X38X34     | 2040    | 2155                  | 2270   | 2385   | 2500                             | 2615                      | 1395   | 1475     | 1555      |
| 050 WEDGE                           | 48X48X34     | 1260    | 1335                  | 1410   | 1485   | 1560                             | 1635                      | 975    | 1040     | 1105      |
| 051 ARMLESS CHAIR                   | 23X38X34     | 885     | 975                   | 1065   | 1155   | 1245                             | 1335                      | 775    | 840      | 905       |
| 052 SOFA LEFT ARM                   | 78X38X34     | 2175    | 2335                  | 2495   | 2655   | 2815                             | 2975                      | 1580   | 1655     | 1730      |
| 053 SOFA RIGHT ARM                  | 78X38X34     | 2175    | 2335                  | 2495   | 2655   | 2815                             | 2975                      | 1580   | 1655     | 1730      |
| 055 SQUARE CORNER                   | 38X38X34     | 1125    | 1220                  | 1315   | 1410   | 1505                             | 1600                      | 890    | 950      | 1010      |
| 056 CHAIR RIGHT ARM                 | 31X38X34     | 1125    | 1220                  | 1315   | 1410   | 1505                             | 1600                      | 890    | 945      | 1000      |
| 057 CHAIR LEFT ARM                  | 31X38X34     | 1125    | 1220                  | 1315   | 1410   | 1505                             | 1600                      | 890    | 945      | 1000      |
| 061 LOVESEAT RIGHT ARM              | 55X38X34     | 1700    | 1820                  | 1940   | 2060   | 2180                             | 2300                      | 1180   | 1270     | 1360      |
| 072 SECTIONAL SOFA LEFT ARM         | 90X38X34     | 2495    | 2660                  | 2825   | 2990   | 3155                             | 3320                      | 1740   | 1815     | 1890      |
| 073 SECTIONAL SOFA RIGHT ARM        | 90X38X34     | 2495    | 2660                  | 2825   | 2990   | 3155                             | 3320                      | 1740   | 1815     | 1890      |
| 086 ARMLESS LOVESEAT BUMPER LEFT    | 67X38X34     | 1700    | 1820                  | 1940   | 2060   | 2180                             | 2300                      | 1180   | 1270     | 1360      |
| <b>CONFIGURATIONS</b>               |              |         |                       |  |  |                                  |                           |        |          |           |
| A CONF. A (12-50-61)                | 103X103X34   | 4660    | 4975                  | 5290   | 5605   | 5920                             | 6235                      | 3335   | 3580     | 3825      |
| B CONF. B (72-61)                   | 90X93X34     | 4195    | 4480                  | 4765   | 5050   | 5335                             | 5620                      | 2920   | 3085     | 3250      |
| C CONF. C (11-53)                   | 67X110X34    | 3535    | 3790                  | 4045   | 4300   | 4555                             | 4810                      | 2620   | 2755     | 2890      |
| D CONF. D (52-05)                   | 110X67X34    | 3535    | 3790                  | 4045   | 4300   | 4555                             | 4810                      | 2620   | 2755     | 2890      |
| E CONF. E (72-45)                   | 90X105X34    | 4195    | 4480                  | 4765   | 5050   | 5335                             | 5620                      | 2920   | 3085     | 3250      |

## CDN Price List

### ALVARO

| Description          | L x D x H  | Leather |                       |  |  |                                  |                           | Fabric |          |           |
|----------------------|------------|---------|-----------------------|--|--|----------------------------------|---------------------------|--------|----------|-----------|
|                      |            | 10      | 20<br>Madras<br>Softy | 30<br>Hugo<br>Fantasy<br>Illusion<br>Tucson<br>Utah<br>Vintage<br>Wild Laredo<br>Yukon | 40<br>Elegance<br>Princess<br>Santiago<br>Sensation<br>Sunset<br>Trina<br>Victoria | 50<br>Bull<br>Cassiope<br>Dublin | 60<br>Caress<br>Ultrasued | A      | B<br>COM | C<br>alta |
| F CONF. F (86-73)    | 105X90X34  | 4195    | 4480                  | 4765   | 5050   | 5335                             | 5620                      | 2920   | 3085     | 3250      |
| G CONF. G (12-50-45) | 103X115X34 | 4660    | 4975                  | 5290   | 5605   | 5920                             | 6235                      | 3335   | 3580     | 3825      |
| H CONF. H (86-50-61) | 115X103X34 | 4660    | 4975                  | 5290   | 5605   | 5920                             | 6235                      | 3335   | 3580     | 3825      |
| I CONF. I (48-53)    | 80X116X34  | 4215    | 4490                  | 4765   | 5040   | 5315                             | 5590                      | 2975   | 3130     | 3285      |
| J CONF. J (52-24)    | 116X80X34  | 4215    | 4490                  | 4765   | 5040   | 5315                             | 5590                      | 2975   | 3130     | 3285      |
| K CONF. K (02-03)    | 63X86X34   | 4430    | 4695                  | 4960   | 5225   | 5490                             | 5755                      | 2990   | 3145     | 3300      |
| L CONF. L (01-03-06) | 40X86X25.5 | 4470    | 4755                  | 5040   | 5325   | 5610                             | 5895                      | 3165   | 3345     | 3525      |
| M CONF. M (72-53)    | 90X116X34  | 4670    | 4995                  | 5320   | 5645   | 5970                             | 6295                      | 3320   | 3470     | 3620      |
| N CONF. N (52-73)    | 116X90X34  | 4670    | 4995                  | 5320   | 5645   | 5970                             | 6295                      | 3320   | 3470     | 3620      |
| O CONF. O (52-50-61) | 126X103X34 | 5135    | 5490                  | 5845   | 6200   | 6555                             | 6910                      | 3735   | 3965     | 4195      |
| P CONF. P (12-50-53) | 103X126X34 | 5135    | 5490                  | 5845   | 6200   | 6555                             | 6910                      | 3735   | 3965     | 4195      |
| Q CONF. Q (52-50-45) | 126X115X34 | 5135    | 5490                  | 5845   | 6200   | 6555                             | 6910                      | 3735   | 3965     | 4195      |
| R CONF. R (86-50-53) | 115X126X34 | 5135    | 5490                  | 5845   | 6200   | 6555                             | 6910                      | 3735   | 3965     | 4195      |

# ALVARO



Hauteur complète 34" | Hauteur de siège 19" | Hauteur devant bras 24" | Profondeur d'assise 21"  
 Total Height 34" | Seat Height 19" | Arm Height 24" | Seat Depth 21"

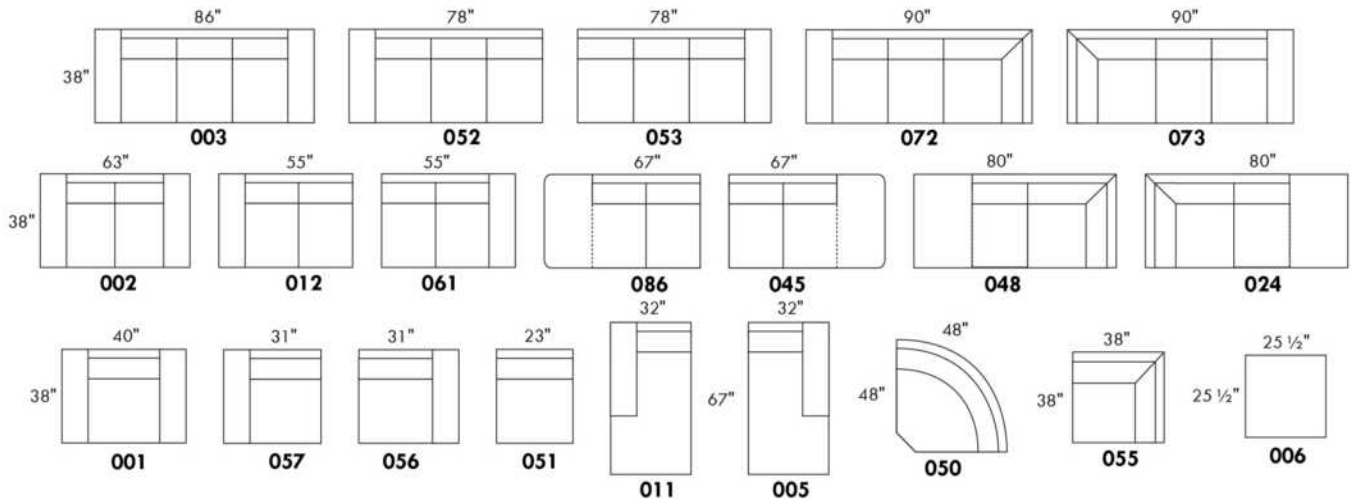

## CONFIGURATIONS

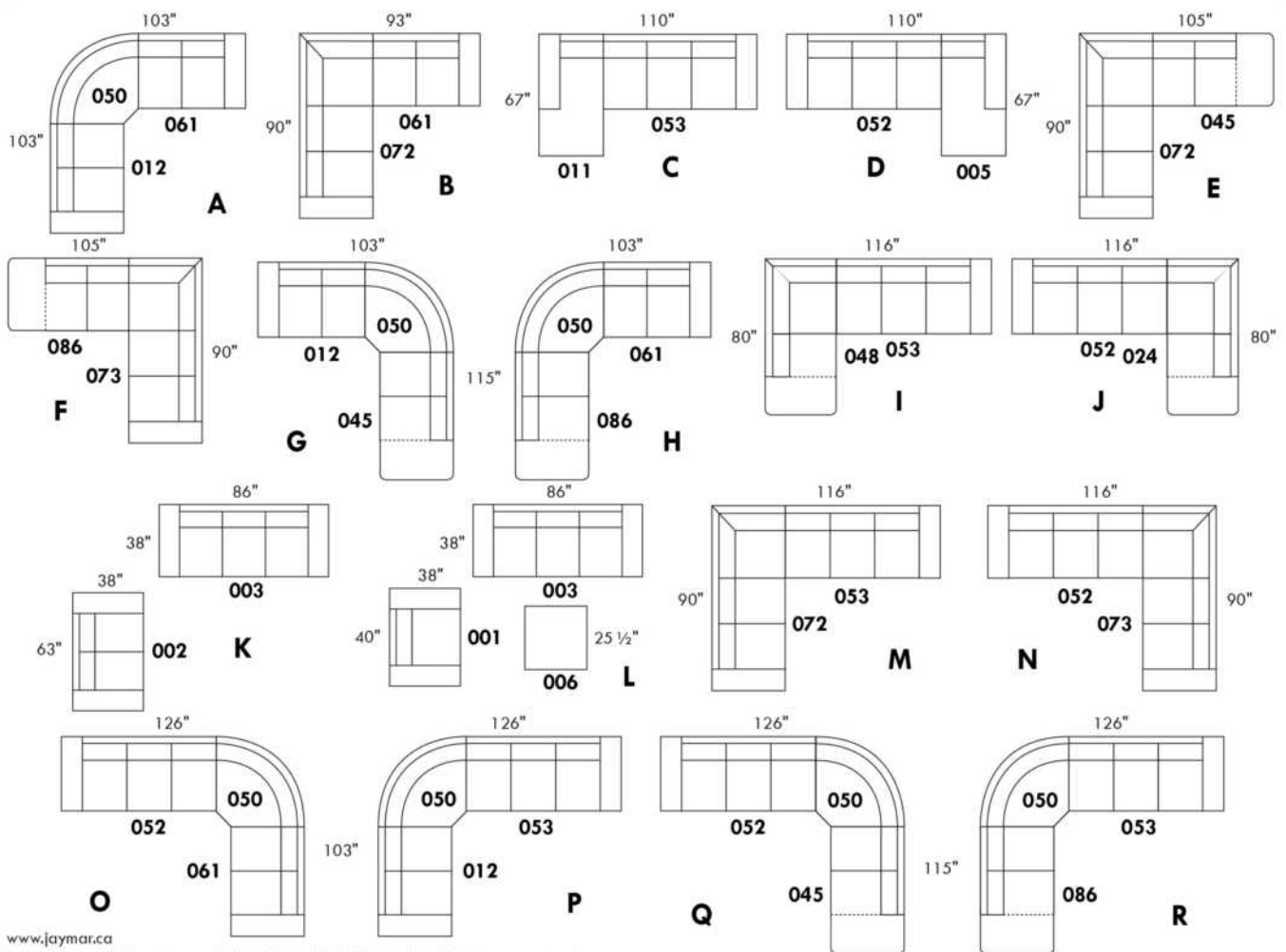

www.jaymar.ca

Toutes les dimensions indiquées sont au pouce près. Nos produits sont fabriqués à la main et des variations mineures peuvent survenir.  
 All dimensions indicated are to the nearest inch. Our product is hand-made and minor variations can occur.



## AMSTERDAM

### FEATURES:

- Manual adjustable headrest on all items (2 on square corner & stationary on wedge).
- \*Wall hugger power recliners with full footrest (manual n/a).
- Power recliner lounge chair (manual n/a) with power headrest in option. Wall clearance 8" & front 5".
- Seat cushions with shaped foam + 1" layer of memory foam on top.
- Stitching: Small thread in fabric & large flat thread in leather.
- \*Excludes 043 & 163 chairs: Wall clearance 16"

Note: 2 recliner seats separated by a corner can not be opened at the same time. No recliner seats beside #155 Small Square Corner.

### OPTIONS

- Battery Pack: add \$160 ea.
- \*Motorized headrest: add \$160 ea. (\*N/A on stationary items).
- Foam: Extra firm add \$15 per seat.
- Choice of Large or Small 6" Arm: Legs on LARGE arm: LG187 wood or LG189 metal (Black or Chrome). SMALL Arm: LG195 wood or LG196 metal (Black or Chrome). Specify colour.
- Seat Depth: 20" or \*22". \*22" seat depth N/A on chairs 043 & 163.
- 043 & 163 Chairs: with wood base (specify colour).

### HOME THEATRE Configurations

For Accessories, Cup holders & Configuration details, see Optima Home Theatre page attached.

Accessory Dock : \$35 ea.

Cup Holders: Metal: \$25 ea. | LED lighted Cup Holder: \$25 ea. | \*LED lighted Cup Holder with (1 or 2 motor) controls: \$40 ea.

\*LED Light strip under seat: \$25/seat.

| Description                        | L x D x H   | Leather |                       |  |  |                                  |                           | Fabric |          |           |
|------------------------------------|-------------|---------|-----------------------|--|--|----------------------------------|---------------------------|--------|----------|-----------|
|                                    |             | 10      | 20<br>Madras<br>Softy | 30<br>Hugo<br>Fantasy<br>Illusion<br>Tucson<br>Utah<br>Vintage<br>Wild Laredo<br>Yukon | 40<br>Elegance<br>Princess<br>Santiago<br>Sensation<br>Sunset<br>Trina<br>Victoria | 50<br>Bull<br>Cassiope<br>Dublin | 60<br>Caress<br>Ultrasued | A      | B<br>COM | C<br>alta |
| 001 CHAIR                          | 45x40x33/40 | 1890    | 1980                  | 2070   | 2160   | 2250                             | 2340                      | 1535   | 1580     | 1625      |
| 002 LOVESEAT                       | 68x40x33/40 | 2700    | 2815                  | 2930   | 3045   | 3160                             | 3275                      | 2175   | 2250     | 2325      |
| 003 SOFA                           | 92x40x33/40 | 3265    | 3415                  | 3565   | 3715   | 3865                             | 4015                      | 2625   | 2715     | 2805      |
| 005 LOUNGE CHAIR RIGHT ARM         | 35x62x33/40 | 1765    | 1830                  | 1895   | 1960   | 2025                             | 2090                      | 1410   | 1470     | 1530      |
| 009 ARMLESS LOVESEAT               | 47x40x33/40 | 1895    | 1965                  | 2035   | 2105   | 2175                             | 2245                      | 1490   | 1570     | 1650      |
| 011 LOUNGE CHAIR LEFT ARM          | 35x62x33/40 | 1765    | 1830                  | 1895   | 1960   | 2025                             | 2090                      | 1410   | 1470     | 1530      |
| 012 LOVESEAT LEFT ARM              | 58x40x33/40 | 2320    | 2420                  | 2520   | 2620   | 2720                             | 2820                      | 1850   | 1925     | 2000      |
| 017 DOUBLE CHAIR                   | 52x40x33/40 | 1980    | 2080                  | 2180   | 2280   | 2380                             | 2480                      | 1600   | 1660     | 1720      |
| 021 APARTMENT SOFA NO ARM          | 61x40x33/40 | 2140    | 2240                  | 2340   | 2440   | 2540                             | 2640                      | 1670   | 1755     | 1840      |
| 040 ARMLESS SOFA                   | 71x40x33/40 | 2450    | 2565                  | 2680   | 2795   | 2910                             | 3025                      | 1950   | 2040     | 2130      |
| 041 RECLINING CHAIR LEFT ARM       | 35x40x33/40 | 1885    | 1960                  | 2035   | 2110   | 2185                             | 2260                      | 1605   | 1640     | 1675      |
| 042 RECLINING CHAIR RIGHT ARM      | 35x40x33/40 | 1885    | 1960                  | 2035   | 2110   | 2185                             | 2260                      | 1605   | 1640     | 1675      |
| 043 SWIVEL ROCKING RECLINING CHAIR | 30x34x42    | 2235    | 2345                  | 2455   | 2565   | 2675                             | 2785                      | 1875   | 1920     | 1965      |
| 044 RECLINER CHAIR                 | 45x40x33/40 | 2275    | 2365                  | 2455   | 2545   | 2635                             | 2725                      | 1920   | 1970     | 2020      |
| 045 ARMLESS LOVESEAT BUMPER RIGHT  | 68x40x33/40 | 2245    | 2340                  | 2435   | 2530   | 2625                             | 2720                      | 1785   | 1850     | 1915      |
| 050 WEDGE                          | 49x49x33    | 1645    | 1745                  | 1845   | 1945   | 2045                             | 2145                      | 1210   | 1270     | 1330      |

## AMSTERDAM

**FEATURES:**

- Manual adjustable headrest on all items (2 on square corner & stationary on wedge).
- \*Wall hugger power recliners with full footrest (manual n/a).
- Power recliner lounge chair (manual n/a) with power headrest in option. Wall clearance 8" & front 5".
- Seat cushions with shaped foam + 1" layer of memory foam on top.
- Stitching: Small thread in fabric & large flat thread in leather.
- \*Excludes 043 & 163 chairs: Wall clearance 16"

Note: 2 recliner seats separated by a corner can not be opened at the same time. No recliner seats beside #155 Small Square Corner.

**OPTIONS**

- Battery Pack: add \$160 ea.
- \*Motorized headrest: add \$160 ea. (\*N/A on stationary items).
- Foam: Extra firm add \$15 per seat.
- Choice of Large or Small 6" Arm: Legs on LARGE arm: LG187 wood or LG189 metal (Black or Chrome). SMALL Arm: LG195 wood or LG196 metal (Black or Chrome). Specify colour.
- Seat Depth: 20" or \*22". \*22" seat depth N/A on chairs 043 & 163.
- 043 & 163 Chairs: with wood base (specify colour).

**HOME THEATRE Configurations**

For Accessories, Cup holders & Configuration details, see Optima Home Theatre page attached.

Accessory Dock : \$35 ea.

Cup Holders: Metal: \$25 ea. | LED lighted Cup Holder: \$25 ea. | \*LED lighted Cup Holder with (1 or 2 motor) controls: \$40 ea.

\*LED Light strip under seat: \$25/seat.

| Description                      | L x D x H     | Leather |                       |  |  |                                  |                            | Fabric |          |           |
|----------------------------------|---------------|---------|-----------------------|--|--|----------------------------------|----------------------------|--------|----------|-----------|
|                                  |               | 10      | 20<br>Madras<br>Softy | 30<br>Hugo<br>Fantasy<br>Illusion<br>Tucson<br>Utah<br>Vintage<br>Wild Laredo<br>Yukon | 40<br>Elegance<br>Princess<br>Santiago<br>Sensation<br>Sunset<br>Trina<br>Victoria | 50<br>Bull<br>Cassiope<br>Dublin | 60<br>Caresse<br>Ultrasued | A      | B<br>COM | C<br>alta |
| 051 ARMLESS CHAIR                | 23,5x40x33/40 | 1085    | 1135                  | 1185   | 1235   | 1285                             | 1335                       | 845    | 900      | 955       |
| 052 SOFA LEFT ARM                | 82x40x33/40   | 2870    | 3005                  | 3140   | 3275   | 3410                             | 3545                       | 2290   | 2385     | 2480      |
| 053 SOFA RIGHT ARM               | 82x40x33/40   | 2870    | 3005                  | 3140   | 3275   | 3410                             | 3545                       | 2290   | 2385     | 2480      |
| 055 SQUARE CORNER                | 44x44x33/40   | 1915    | 2010                  | 2105   | 2200   | 2295                             | 2390                       | 1510   | 1565     | 1620      |
| 056 CHAIR RIGHT ARM              | 35x40x33/40   | 1510    | 1575                  | 1640   | 1705   | 1770                             | 1835                       | 1200   | 1260     | 1320      |
| 057 CHAIR LEFT ARM               | 35x40x33/40   | 1510    | 1575                  | 1640   | 1705   | 1770                             | 1835                       | 1200   | 1260     | 1320      |
| 061 LOVESEAT RIGHT ARM           | 58x40x33/40   | 2320    | 2420                  | 2520   | 2620   | 2720                             | 2820                       | 1850   | 1925     | 2000      |
| 071 ARMLESS RECLINING CHAIR      | 23,5x40x33/40 | 1470    | 1525                  | 1580   | 1635   | 1690                             | 1745                       | 1250   | 1310     | 1370      |
| 086 ARMLESS LOVESEAT BUMPER LEFT | 68x40x33/40   | 2245    | 2340                  | 2435   | 2530   | 2625                             | 2720                       | 1785   | 1850     | 1915      |
| 088 ARMLESS CHAIR BUMPER LEFT    | 45x40x33/40   | 1440    | 1535                  | 1630   | 1725   | 1820                             | 1915                       | 1130   | 1165     | 1200      |
| 089 ARMLESS CHAIR BUMPER RIGHT   | 45x40x33/40   | 1440    | 1535                  | 1630   | 1725   | 1820                             | 1915                       | 1130   | 1165     | 1200      |
| 095 APARTMENT SOFA               | 82x40x33/40   | 2940    | 3085                  | 3230   | 3375   | 3520                             | 3665                       | 2350   | 2445     | 2540      |
| 096 APARTMENT SOFA LEFT ARM      | 72x40x33/40   | 2570    | 2680                  | 2790   | 2900   | 3010                             | 3120                       | 2020   | 2110     | 2200      |
| 097 APARTMENT SOFA RIGHT ARM     | 72x40x33/40   | 2570    | 2680                  | 2790   | 2900   | 3010                             | 3120                       | 2020   | 2110     | 2200      |
| 124 STORAGE OTTOMAN              | 30x22x17      | 745     | 765                   | 785  | 805  | 825                              | 845                        | 650    | 670      | 690       |
| 138 STRAIGHT ARM                 | 9.25x36x24    | 415     | 450                   | 485  | 520  | 555                              | 590                        | 350    | 365      | 380       |

## AMSTERDAM

### FEATURES:

- Manual adjustable headrest on all items (2 on square corner & stationary on wedge).
- \*Wall hugger power recliners with full footrest (manual n/a).
- Power recliner lounge chair (manual n/a) with power headrest in option. Wall clearance 8" & front 5".
- Seat cushions with shaped foam + 1" layer of memory foam on top.
- Stitching: Small thread in fabric & large flat thread in leather.
- \*Excludes 043 & 163 chairs: Wall clearance 16"

Note: 2 recliner seats separated by a corner can not be opened at the same time. No recliner seats beside #155 Small Square Corner.

### OPTIONS

- Battery Pack: add \$160 ea.
- \*Motorized headrest: add \$160 ea. (\*N/A on stationary items).
- Foam: Extra firm add \$15 per seat.
- Choice of Large or Small 6" Arm: Legs on LARGE arm: LG187 wood or LG189 metal (Black or Chrome). SMALL Arm: LG195 wood or LG196 metal (Black or Chrome). Specify colour.
- Seat Depth: 20" or \*22". \*22" seat depth N/A on chairs 043 & 163.
- 043 & 163 Chairs: with wood base (specify colour).

### HOME THEATRE Configurations

For Accessories, Cup holders & Configuration details, see Optima Home Theatre page attached.

Accessory Dock : \$35 ea.

Cup Holders: Metal: \$25 ea. | LED lighted Cup Holder: \$25 ea. | \*LED lighted Cup Holder with (1 or 2 motor) controls: \$40 ea.

\*LED Light strip under seat: \$25/seat.

| Description                            | L x D x H     | Leather |                       |  |  |                                  |                           | Fabric |          |           |
|--|---------------|---------|-----------------------|--|--|----------------------------------|---------------------------|--------|----------|-----------|
|  |               | 10      | 20<br>Madras<br>Softy | 30<br>Hugo<br>Fantasy<br>Illusion<br>Tucson<br>Utah<br>Vintage<br>Wild Laredo<br>Yukon | 40<br>Elegance<br>Princess<br>Santiago<br>Sensation<br>Sunset<br>Trina<br>Victoria | 50<br>Bull<br>Cassiope<br>Dublin | 60<br>Caress<br>Ultrasued | A      | B<br>COM | C<br>alta |
| 155 SMALL SQUARE CORNER                | 40x40x33/40   | 1915    | 2010                  | 2105   | 2200   | 2295                             | 2390                      | 1510   | 1565     | 1620      |
| 159 WEDGE STORAGE                      | 11/27x36x24   | 745     | 775                   | 805  | 835  | 865                              | 895                       | 585    | 600      | 615       |
| 160 STRAIGHT STORAGE                   | 11x36x24      | 720     | 745                   | 770  | 795  | 820                              | 845                       | 550    | 570      | 590       |
| 163 DBL SWIVEL ROCKING RECLINER CHAIR  | 33x34x42      | 2290    | 2410                  | 2530   | 2650   | 2770                             | 2890                      | 1880   | 1930     | 1980      |
| 165 DOUBLE RECLINING CHAIR             | 52x40x33/40   | 2375    | 2475                  | 2575   | 2675   | 2775                             | 2875                      | 2000   | 2065     | 2130      |
| 167 APARTMENT SOFA NO ARM BUMPER LEFT  | 82x40x33/40   | 2490    | 2620                  | 2750   | 2880   | 3010                             | 3140                      | 1960   | 2045     | 2130      |
| 168 APARTMENT SOFA NO ARM BUMPER RIGHT | 82x40x33/40   | 2490    | 2620                  | 2750   | 2880   | 3010                             | 3140                      | 1960   | 2045     | 2130      |
| 169 DOUBLE RECLINING CHAIR LEFT ARM    | 42x40x33/40   | 1990    | 2070                  | 2150   | 2230   | 2310                             | 2390                      | 1670   | 1750     | 1830      |
| 170 DOUBLE RECLINING CHAIR RIGHT ARM   | 42x40x33/40   | 1990    | 2070                  | 2150   | 2230   | 2310                             | 2390                      | 1670   | 1750     | 1830      |
| 171 ARMLESS DOUBLE RECLINING CHAIR     | 30,5x40x33/40 | 1575    | 1625                  | 1675   | 1725   | 1775                             | 1825                      | 1320   | 1380     | 1440      |
| 173 DOUBLE LOUNGE CHAIR LEFT ARM       | 42x62x33/40   | 1915    | 2005                  | 2095   | 2185   | 2275                             | 2365                      | 1535   | 1615     | 1695      |
| 174 DOUBLE LOUNGE CHAIR RIGHT ARM      | 42x62x33/40   | 1915    | 2005                  | 2095   | 2185   | 2275                             | 2365                      | 1535   | 1615     | 1695      |
| 175 DOUBLE CHAIR LEFT ARM              | 42x40x33/40   | 1590    | 1680                  | 1770   | 1860   | 1950                             | 2040                      | 1285   | 1350     | 1415      |
| 176 DOUBLE CHAIR RIGHT ARM             | 42x40x33/40   | 1590    | 1680                  | 1770   | 1860   | 1950                             | 2040                      | 1285   | 1350     | 1415      |
| 177 ARMLESS DOUBLE CHAIR               | 30,5x40x33/40 | 1185    | 1250                  | 1315   | 1380   | 1445                             | 1510                      | 915    | 970      | 1025      |
| 178 ARMLESS DOUBLE CHAIR BUMPER LEFT   | 52x40x33/40   | 1545    | 1625                  | 1705   | 1785   | 1865                             | 1945                      | 1230   | 1290     | 1350      |

## AMSTERDAM

### FEATURES:

- Manual adjustable headrest on all items (2 on square corner & stationary on wedge).
- \*Wall hugger power recliners with full footrest (manual n/a).
- Power recliner lounge chair (manual n/a) with power headrest in option. Wall clearance 8" & front 5".
- Seat cushions with shaped foam + 1" layer of memory foam on top.
- Stitching: Small thread in fabric & large flat thread in leather.
- \*Excludes 043 & 163 chairs: Wall clearance 16"

Note: 2 recliner seats separated by a corner can not be opened at the same time. No recliner seats beside #155 Small Square Corner.

### OPTIONS

- Battery Pack: add \$160 ea.
- \*Motorized headrest: add \$160 ea. (\*N/A on stationary items).
- Foam: Extra firm add \$15 per seat.
- Choice of Large or Small 6" Arm: Legs on LARGE arm: LG187 wood or LG189 metal (Black or Chrome). SMALL Arm: LG195 wood or LG196 metal (Black or Chrome). Specify colour.
- Seat Depth: 20" or \*22". \*22" seat depth N/A on chairs 043 & 163.
- 043 & 163 Chairs: with wood base (specify colour).

### HOME THEATRE Configurations

For Accessories, Cup holders & Configuration details, see Optima Home Theatre page attached.

Accessory Dock : \$35 ea.

Cup Holders: Metal: \$25 ea. | LED lighted Cup Holder: \$25 ea. | \*LED lighted Cup Holder with (1 or 2 motor) controls: \$40 ea.

\*LED Light strip under seat: \$25/seat.

| Description                            | L x D x H       | Leather |                       |  |  |                                  |                           | Fabric |          |           |
|--|-----------------|---------|-----------------------|--|--|----------------------------------|---------------------------|--------|----------|-----------|
|  |                 | 10      | 20<br>Madras<br>Softy | 30<br>Hugo<br>Fantasy<br>Illusion<br>Tucson<br>Utah<br>Vintage<br>Wild Laredo<br>Yukon | 40<br>Elegance<br>Princess<br>Santiago<br>Sensation<br>Sunset<br>Trina<br>Victoria | 50<br>Bull<br>Cassiope<br>Dublin | 60<br>Caress<br>Ultrasued | A      | B<br>COM | C<br>alta |
| 179 ARMLESS DOUBLE CHAIR BUMPER RIGHT  | 52x40x33/40     | 1545    | 1625                  | 1705   | 1785   | 1865                             | 1945                      | 1230   | 1290     | 1350      |
| 186 ARMLESS LOVESEAT BUMPER STORAGE-L  | 68x40x33/40     | 2420    | 2500                  | 2580   | 2660   | 2740                             | 2820                      | 1950   | 2015     | 2080      |
| 187 ARMLESS LOVESEAT BUMPER STORAGE-R  | 68x40x33/40     | 2420    | 2500                  | 2580   | 2660   | 2740                             | 2820                      | 1950   | 2015     | 2080      |
| 188 ARMLESS CHAIR BUMPER STORAGE-L     | 45x40x33/40     | 1600    | 1690                  | 1780   | 1870   | 1960                             | 2050                      | 1295   | 1330     | 1365      |
| 189 ARMLESS CHAIR BUMPER STORAGE-R     | 45x40x33/40     | 1600    | 1690                  | 1780   | 1870   | 1960                             | 2050                      | 1295   | 1330     | 1365      |
| 190 SMALL WEDGE STORAGE                | 11/21x36x24     | 720     | 745                   | 770  | 795  | 820                              | 845                       | 550    | 570      | 590       |
| 221 ARMLESS DBL CHAIR BUMPER STORAGE-L | 52x40x33/40     | 1705    | 1790                  | 1875   | 1960   | 2045                             | 2130                      | 1390   | 1450     | 1510      |
| 222 ARMLESS DBL CHAIR BUMPER STORAGE-R | 52x40x33/40     | 1705    | 1790                  | 1875   | 1960   | 2045                             | 2130                      | 1390   | 1450     | 1510      |
| 223 APT SOFA NO ARM BUMPER STORAGE-L   | 82x40x33/40     | 2655    | 2785                  | 2915   | 3045   | 3175                             | 3305                      | 2120   | 2215     | 2310      |
| 224 APT SOFA NO ARM BUMPER STORAGE-R   | 82x40x33/40     | 2655    | 2785                  | 2915   | 3045   | 3175                             | 3305                      | 2120   | 2215     | 2310      |
| 236 RECLINING LOUNGE CHAIR LEFT ARM    | 35x62x33/40     | 2160    | 2225                  | 2290   | 2355   | 2420                             | 2485                      | 1820   | 1880     | 1940      |
| 237 RECLINING LOUNGE CHAIR RIGHT ARM   | 35x62x33/40     | 2160    | 2225                  | 2290   | 2355   | 2420                             | 2485                      | 1820   | 1880     | 1940      |
| 238 RECLINING DBL LOUNGE CHAIR L-ARM   | 42x62x33/40     | 2315    | 2405                  | 2495   | 2585   | 2675                             | 2765                      | 1940   | 2020     | 2100      |
| 239 RECLINING DBL LOUNGE CHAIR R-ARM   | 42x62x33/40     | 2315    | 2405                  | 2495   | 2585   | 2675                             | 2765                      | 1940   | 2020     | 2100      |
| V51 WINE GLASS HOLDER                  | 3.5 x 5.5 x 6.5 | 35      | 35                    | 35   | 35   | 35                               | 35                        | 35     | 35       | 35        |
| V52 PLASTIC SWIVEL TRAY                | 13 3/8 x 9 5/8  | 35      | 35                    | 35   | 35   | 35                               | 35                        | 35     | 35       | 35        |

## AMSTERDAM

### FEATURES:

- Manual adjustable headrest on all items (2 on square corner & stationary on wedge).
- \*Wall hugger power recliners with full footrest (manual n/a).
- Power recliner lounge chair (manual n/a) with power headrest in option. Wall clearance 8" & front 5".
- Seat cushions with shaped foam + 1" layer of memory foam on top.
- Stitching: Small thread in fabric & large flat thread in leather.
- \*Excludes 043 & 163 chairs: Wall clearance 16"

Note: 2 recliner seats separated by a corner can not be opened at the same time. No recliner seats beside #155 Small Square Corner.

### OPTIONS

- Battery Pack: add \$160 ea.
- \*Motorized headrest: add \$160 ea. (\*N/A on stationary items).
- Foam: Extra firm add \$15 per seat.
- Choice of Large or Small 6" Arm: Legs on LARGE arm: LG187 wood or LG189 metal (Black or Chrome). SMALL Arm: LG195 wood or LG196 metal (Black or Chrome). Specify colour.
- Seat Depth: 20" or \*22". \*22" seat depth N/A on chairs 043 & 163.
- 043 & 163 Chairs: with wood base (specify colour).

### HOME THEATRE Configurations

For Accessories, Cup holders & Configuration details, see Optima Home Theatre page attached.

Accessory Dock : \$35 ea.

Cup Holders: Metal: \$25 ea. | LED lighted Cup Holder: \$25 ea. | \*LED lighted Cup Holder with (1 or 2 motor) controls: \$40 ea.

\*LED Light strip under seat: \$25/seat.

| Description                 | L x D x H          | Leather |                       |  |  |                                  |                           | Fabric |          |           |    |
|-----------------------------|--------------------|---------|-----------------------|--|--|----------------------------------|---------------------------|--------|----------|-----------|----|
|                             |                    | 10      | 20<br>Madras<br>Softy | 30<br>Hugo<br>Fantasy<br>Illusion<br>Tucson<br>Utah<br>Vintage<br>Wild Laredo<br>Yukon | 40<br>Elegance<br>Princess<br>Santiago<br>Sensation<br>Sunset<br>Trina<br>Victoria | 50<br>Bull<br>Cassiope<br>Dublin | 60<br>Caress<br>Ultrasued | A      | B<br>COM | C<br>alta |    |
| V53 WOOD SWIVEL TRAY        | 19 x 10            | 60      | 60                    | 60   | 60   | 60                               | 60                        | 60     | 60       | 60        | 60 |
| V54 TABLET HOLDER           | 4.5 x 8 x 10       | 40      | 40                    | 40   | 40   | 40                               | 40                        | 40     | 40       | 40        | 40 |
| V55 LED LAMP                | 1.5x5x14 plié/bent | 35      | 35                    | 35   | 35   | 35                               | 35                        | 35     | 35       | 35        | 35 |
| <b>CONFIGURATIONS</b>       |                    |         |                       |  |  |                                  |                           |        |          |           |    |
| _A CONFIG (169-170)         | 84X40X40           | 3980    | 4140                  | 4300   | 4460   | 4620                             | 4780                      | 3340   | 3500     | 3660      |    |
| _B CONFIG (169-171-174)     | 115X62X40          | 5480    | 5700                  | 5920   | 6140   | 6360                             | 6580                      | 4525   | 4745     | 4965      |    |
| _C CONFIG (096-055-171-170) | 116X116X40         | 8050    | 8385                  | 8720   | 9055   | 9390                             | 9725                      | 6520   | 6805     | 7090      |    |
| _D CONFIG (169-171-055-179) | 116X96X40          | 7025    | 7330                  | 7635   | 7940   | 8245                             | 8550                      | 5730   | 5985     | 6240      |    |
| _J CONFIG (041-042)         | 70X40X40           | 3770    | 3920                  | 4070   | 4220   | 4370                             | 4520                      | 3210   | 3280     | 3350      |    |
| _K CONFIG (041-071-005)     | 94X62X40           | 5120    | 5315                  | 5510   | 5705   | 5900                             | 6095                      | 4265   | 4420     | 4575      |    |
| _L CONFIG (012-055-071-042) | 102X102X40         | 7590    | 7915                  | 8240   | 8565   | 8890                             | 9215                      | 6215   | 6440     | 6665      |    |
| _M CONFIG (041-071-055-089) | 103X89X40          | 6710    | 7030                  | 7350   | 7670   | 7990                             | 8310                      | 5495   | 5680     | 5865      |    |



# AMSTERDAM

**OPTIMA**  
Collection

**Jaymar**

Conçu et fabriqué fièrement au Canada  
Proudly designed and made in Canada

Nos produits sont fabriqués à la main et des variations mineures peuvent survenir.

Our product is hand-made and minor variations can occur.

## SPECIFICATIONS

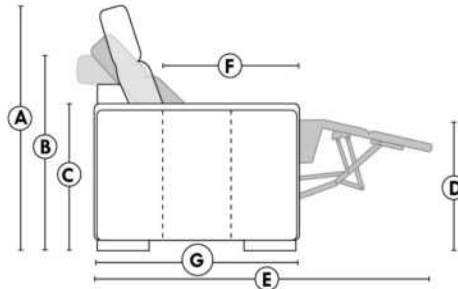

- Appui-tête levé Headrest up
- Appui-tête baissé Headrest down
- Complètement incliné Fully reclined

- A** Hauteur complète 40" Total Height
- B** Hauteur appui-tête baissé 33" Height headrest down
- C** Hauteur du bras 24" Arm Height
- D** Hauteur du siège 19,5" Seat height
- E** Profondeur inclinée 65" Depth fully reclined
- F** Profondeur d'assise 20"ou/ou 22" Seat depth
- G** Profondeur appui-tête monté 37,5" Depth with headrest up

## BRAS | ARMS

Option de bras:  
Bras Régulier Large 10,5" ou Petit bras 6"

Arm option  
Regular arm Large 10,5" or Small arm 6"

Contrôle de l'inclinaison situé à l'intérieur du bras  
Recliner control located on the inside of the arm.

Option d'accessoires disponible sur le bras régulier seulement  
Accessories option, available on Regular arms ONLY.

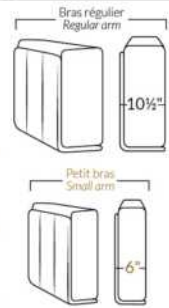

## FAUTEUIL BERÇANT PIVOTANT INCLINABLE SWIVEL ROCKING MOTION CHAIR



## SIÈGE 23" DE LARGE | 23" SEAT WIDTH

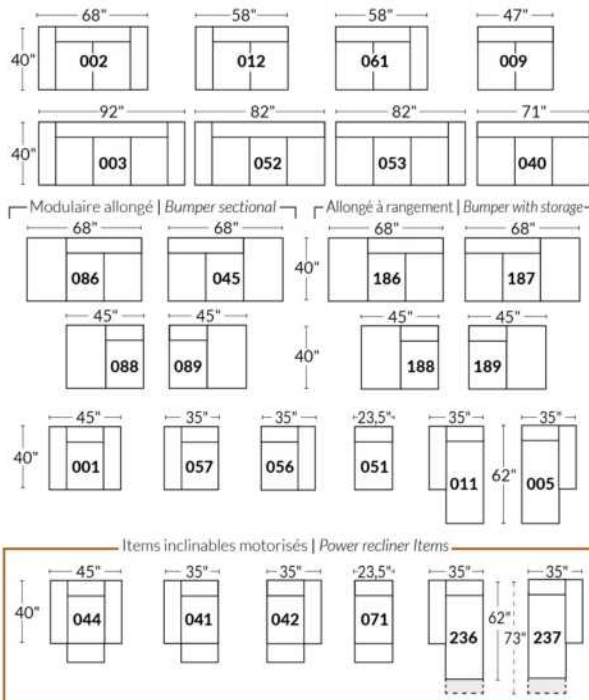

## SIÈGE 30" DE LARGE | 30" SEAT WIDTH

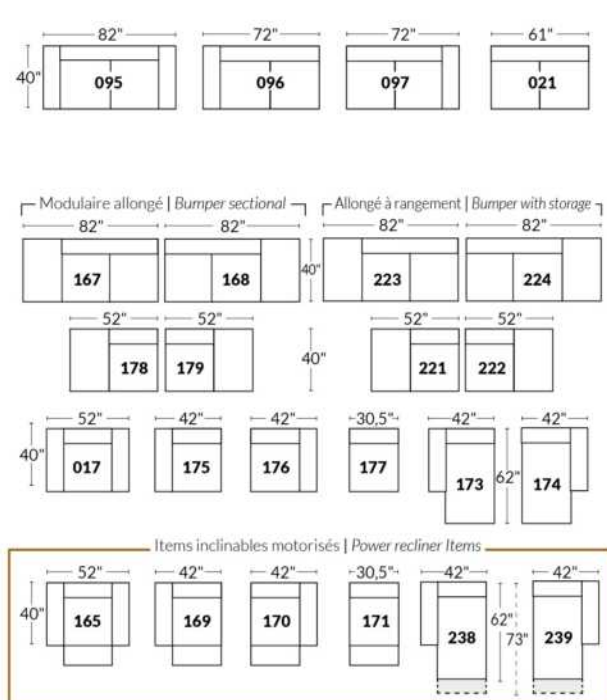

### Autres | Others

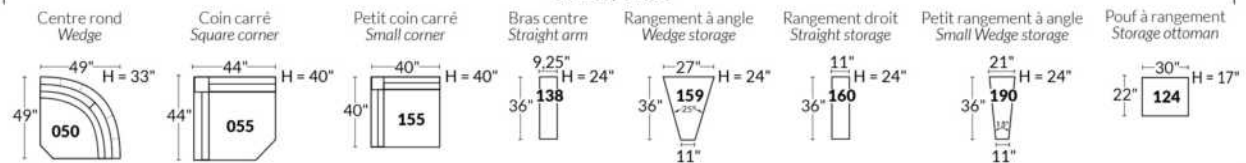

### EXEMPLE 23" EXAMPLE

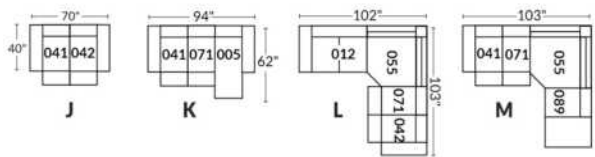

### EXEMPLE 30" EXAMPLE

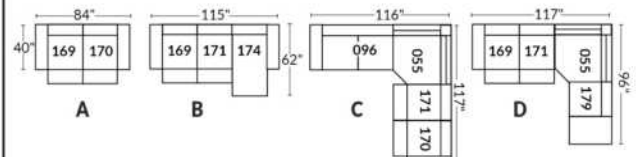

\*Available on certain models and on large arms ONLY.

### OPTIONS CUP HOLDERS

#### METAL



Silver



Matte Black



Brown

#### ILLUMINATED

1.



LED Lighted Cup holder

2.



LED Lighted Cup holder with Single Motor Control, USB Port and LED Base rail

3.



LED Lighted Cup holder with Dual Motor Control, USB Port and LED Base rail

Our illuminated one or two-control cup holders are compatible with LED lights under the seat. You can control the light on the cup holder. The 2 motor cup holder has a reset (home) button control to close your recliner back to its starting position.

#### LED Light under seat (Optional)

Available only in configurations with a minimum of 1 illuminated motorized cup holder with control buttons. The "light" button will control the opening and closing of the light.

For cup holder prices see description section of the Optima model price list.

Please provide us with a drawing of your configuration which indicates the cup holder type and its positioning.

#### Cup holder with controller:

It is important to specify the placement of the cups; on left arm or right arm and which recliner they will control. If you have a row of several seats with cup holders, by default, the controls will be on the left arms and on the right arm for the last outer chair.

#### EXAMPLE A:

041-169: Controller and cup holder on the left arm

071-171: hidden touch sensor buttons on side of seat

042-170: Controller and cup holder on right arm



#### EXAMPLE B:

071-171: These two items can be connected to a smart cup holder which will control the recliner. You must then use one of these items: 138, 159, 160 and 190



#### Informations about headrest, controller on reclining seat

#### WITH illuminated cup holder

If you have a stationary item, you will have cup holder N°1.

If you have a recliner chair with a manual headrest, you will have the cup holder N°2.

If you have a recliner chair with an electric headrest, you will have cup holder N°3.

#### Without cup holder and with a reclining seat

If you have a recliner with a manual headrest you will have the touch sensor button control on the side of the seat.

If you have a recliner with an electric headrest you will have a dual push button controller with USB port on the arm.

If you have an armless recliner, you will have the hidden touch sensor button control.



Hidden touch sensor



Dual push button









# OPTIMA

## HOME THEATRE Configurations

\*Available on certain models and on large arms ONLY.

### OPTIONS ACCESSORIES

|   |   |  |   |
|---|---|--|---|
| <p><b>Accessory Dock</b></p>         | <p><b>V51<br/>Wine Glass Holder</b></p>  | <p><b>V52<br/>Plastic Swivel Tray Table</b></p>  | <p><b>V53<br/>Wood Swivel tray Table<br/>(Choice of 8 colors)</b></p>  <p>Specify on which arm (left or right) the tray table will be installed.</p> |
| <p><b>V54<br/>Tablet Holder</b></p>  | <p><b>V55<br/>LED Lamp</b></p>           |  |   |

(For Accessory Dock price, see description section of the Optima model price list and for Accessory item prices, see at very end of the price list)

**Items 138-159-160-190 and large arm.**

Accessory docks and cups are Optional. \*Not available on small arms\*  
 Please specify on which arms you want the accessory docks and cup holders.  
 NB: Item 138-159-160-190 are unfinished on the sides, must be used between 2 seats.  
 Each storage item has 2 USB ports and one electrical outlet inside the storage.

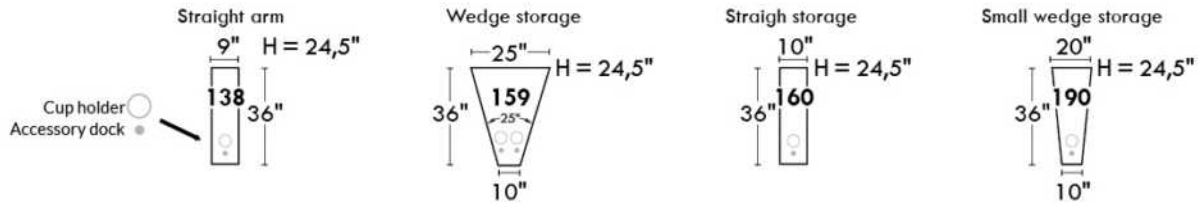

**SUGGESTED CONFIGURATIONS**

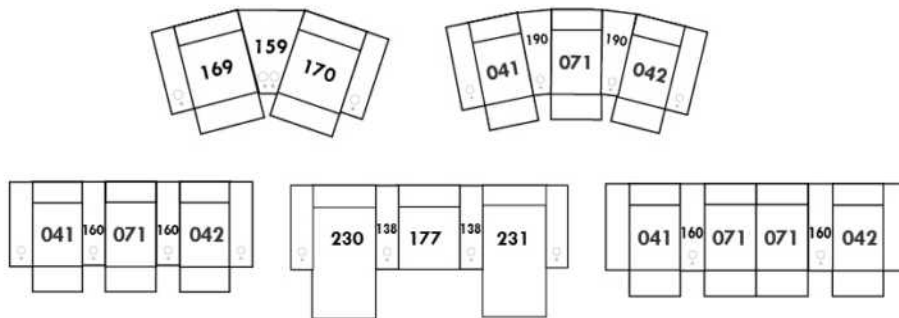



## CDN Price List

### ARMANI

LEGS: Specify wood leg colour LG35; ottoman LG68.

COMBO: Cover #2 on back and seat.

OPTIONS: LEATHER option: Specify front seat and arms if leather "Weave".

Sofa bed MATTRESS: Regular 4.5" mattress included. OPTIONAL 5" mattress:

-with coils and memory foam with gel: add \$100 or

-with high density foam and memory foam with gel: add \$150.

\*REMARK: In leather, armless end pieces are not fully upholstered.

| Description                       | L x D x H    | Leather |                       |  |  |                                  |                           | Fabric |          |           |
|-----------------------------------|--------------|---------|-----------------------|--|--|----------------------------------|---------------------------|--------|----------|-----------|
|                                   |              | 10      | 20<br>Madras<br>Softy | 30<br>Hugo<br>Fantasy<br>Illusion<br>Tucson<br>Utah<br>Vintage<br>Wild Laredo<br>Yukon | 40<br>Elegance<br>Princess<br>Santiago<br>Sensation<br>Sunset<br>Trina<br>Victoria | 50<br>Bull<br>Cassiope<br>Dublin | 60<br>Caress<br>Ultrasued | A      | B<br>COM | C<br>alta |
| 001 CHAIR                         | 39 X 37 X 35 | 1360    | 1455                  | 1550   | 1645   | 1740                             | 1835                      | 975    | 1035     | 1095      |
| 002 LOVESEAT                      | 63X37X35     | 1980    | 2085                  | 2190   | 2295   | 2400                             | 2505                      | 1305   | 1360     | 1415      |
| 003 SOFA                          | 86X37X35     | 2450    | 2610                  | 2770   | 2930   | 3090                             | 3250                      | 1625   | 1715     | 1805      |
| 005 LOUNGE CHAIR RIGHT ARM        | 32X66X35     | 1540    | 1620                  | 1700   | 1780   | 1860                             | 1940                      | 1150   | 1215     | 1280      |
| 006 OTTOMAN                       | 25.5X25.5X18 | 685     | 710                   | 735  | 760  | 785                              | 810                       | 550    | 570      | 590       |
| 009 ARMLESS LOVESEAT              | 46X37X35     | 1440    | 1575                  | 1710   | 1845   | 1980                             | 2115                      | 980    | 1045     | 1110      |
| 011 LOUNGE CHAIR LEFT ARM         | 32X66X35     | 1540    | 1620                  | 1700   | 1780   | 1860                             | 1940                      | 1150   | 1215     | 1280      |
| 012 LOVESEAT LEFT ARM             | 55X37X35     | 1700    | 1820                  | 1940   | 2060   | 2180                             | 2300                      | 1150   | 1220     | 1290      |
| 015 SWIVEL CHAIR                  | 39X37X36     | 1470    | 1570                  | 1670   | 1770   | 1870                             | 1970                      | 1095   | 1145     | 1195      |
| 018 ANGULAR LOVESEAT LEFT ARM     | 64X55X35     | 1750    | 1860                  | 1970   | 2080   | 2190                             | 2300                      | 1230   | 1310     | 1390      |
| 023 ANGULAR LOVESEAT RIGHT ARM    | 64X55X35     | 1750    | 1860                  | 1970   | 2080   | 2190                             | 2300                      | 1230   | 1310     | 1390      |
| 040 ARMLESS SOFA                  | 69X37X35     | 1910    | 2060                  | 2210   | 2360   | 2510                             | 2660                      | 1305   | 1375     | 1445      |
| 045 ARMLESS LOVESEAT BUMPER RIGHT | 67X37X35     | 1795    | 1930                  | 2065   | 2200   | 2335                             | 2470                      | 1290   | 1350     | 1410      |
| 046 ARMLESS ANGULAR LOVESEAT      | 58X49X35     | 1635    | 1765                  | 1895   | 2025   | 2155                             | 2285                      | 1170   | 1245     | 1320      |
| 050 WEDGE                         | 48X48X35     | 1260    | 1335                  | 1410   | 1485   | 1560                             | 1635                      | 945    | 1000     | 1055      |
| 051 ARMLESS CHAIR                 | 23X37X35     | 855     | 945                   | 1035   | 1125   | 1215                             | 1305                      | 715    | 765      | 815       |
| 052 SOFA LEFT ARM                 | 78X37X35     | 2175    | 2335                  | 2495   | 2655   | 2815                             | 2975                      | 1485   | 1570     | 1655      |
| 053 SOFA RIGHT ARM                | 78X37X35     | 2175    | 2335                  | 2495   | 2655   | 2815                             | 2975                      | 1485   | 1570     | 1655      |
| 055 SQUARE CORNER                 | 37X37X35     | 1205    | 1300                  | 1395   | 1490   | 1585                             | 1680                      | 890    | 945      | 1000      |
| 056 CHAIR RIGHT ARM               | 32X37X35     | 1110    | 1195                  | 1280   | 1365   | 1450                             | 1535                      | 825    | 890      | 955       |
| 057 CHAIR LEFT ARM                | 32X37X35     | 1110    | 1195                  | 1280   | 1365   | 1450                             | 1535                      | 825    | 890      | 955       |
| 060 QUEEN SOFA BED                | 86X37X35     | 2820    | 2980                  | 3140   | 3300   | 3460                             | 3620                      | 2105   | 2190     | 2275      |
| 061 LOVESEAT RIGHT ARM            | 55X37X35     | 1700    | 1820                  | 1940   | 2060   | 2180                             | 2300                      | 1150   | 1220     | 1290      |
| 072 SECTIONAL SOFA LEFT ARM       | 90X37X35     | 2495    | 2660                  | 2825   | 2990   | 3155                             | 3320                      | 1720   | 1800     | 1880      |

## CDN Price List

### ARMANI

LEGS: Specify wood leg colour LG35; ottoman LG68.

COMBO: Cover #2 on back and seat.

OPTIONS: LEATHER option: Specify front seat and arms if leather "Weave".

Sofa bed MATTRESS: Regular 4.5" mattress included. OPTIONAL 5" mattress:

-with coils and memory foam with gel: add \$100 or

-with high density foam and memory foam with gel: add \$150.

\*REMARK: In leather, armless end pieces are not fully upholstered.

| Description                      | L x D x H  | Leather |                       |  |  |                                  |                           | Fabric |          |           |
|----------------------------------|------------|---------|-----------------------|--|--|----------------------------------|---------------------------|--------|----------|-----------|
|                                  |            | 10      | 20<br>Madras<br>Softy | 30<br>Hugo<br>Fantasy<br>Illusion<br>Tucson<br>Utah<br>Vintage<br>Wild Laredo<br>Yukon | 40<br>Elegance<br>Princess<br>Santiago<br>Sensation<br>Sunset<br>Trina<br>Victoria | 50<br>Bull<br>Cassiope<br>Dublin | 60<br>Caress<br>Ultrasued | A      | B<br>COM | C<br>alta |
| 073 SECTIONAL SOFA RIGHT ARM     | 90X37X35   | 2495    | 2660                  | 2825   | 2990   | 3155                             | 3320                      | 1720   | 1800     | 1880      |
| 080 ANGULAR OTTOMAN              | 36X27X18   | 760     | 805                   | 850  | 895  | 940                              | 985                       | 645    | 670      | 695       |
| 082 QUEEN SOFA BED LEFT ARM      | 78X37X35   | 2535    | 2700                  | 2865   | 3030   | 3195                             | 3360                      | 1955   | 2035     | 2115      |
| 083 QUEEN SOFA BED RIGHT ARM     | 78X37X35   | 2535    | 2700                  | 2865   | 3030   | 3195                             | 3360                      | 1955   | 2035     | 2115      |
| 086 ARMLESS LOVESEAT BUMPER LEFT | 67X37X35   | 1795    | 1930                  | 2065   | 2200   | 2335                             | 2470                      | 1290   | 1350     | 1410      |
| 088 ARMLESS CHAIR BUMPER LEFT    | 44X37X35   | 1205    | 1300                  | 1395   | 1490   | 1585                             | 1680                      | 1005   | 1060     | 1115      |
| 089 ARMLESS CHAIR BUMPER RIGHT   | 44X37X35   | 1205    | 1300                  | 1395   | 1490   | 1585                             | 1680                      | 1005   | 1060     | 1115      |
| <b>CONFIGURATIONS</b>            |            |         |                       |  |  |                                  |                           |        |          |           |
| A CONF. A (057-050-009-005)      | 126X80X35  | 5350    | 5725                  | 6100   | 6475   | 6850                             | 7225                      | 3900   | 4150     | 4400      |
| B CONF. B (018-023)              | 128X55X35  | 3500    | 3720                  | 3940   | 4160   | 4380                             | 4600                      | 2460   | 2620     | 2780      |
| C CONF. C (086-055-045)          | 104X104X35 | 4795    | 5160                  | 5525   | 5890   | 6255                             | 6620                      | 3470   | 3645     | 3820      |
| D CONF. D (086-050-053)          | 126X115X35 | 5230    | 5600                  | 5970   | 6340   | 6710                             | 7080                      | 3720   | 3920     | 4120      |
| E CONF. E (057-073)              | 92X69X35   | 3605    | 3855                  | 4105   | 4355   | 4605                             | 4855                      | 2545   | 2690     | 2835      |
| F CONF. F (012-050-083)          | 126X103X35 | 5495    | 5855                  | 6215   | 6575   | 6935                             | 7295                      | 4050   | 4255     | 4460      |
| G CONF. G (012-050-061)          | 103X103X35 | 4660    | 4975                  | 5290   | 5605   | 5920                             | 6235                      | 3245   | 3440     | 3635      |
| H CONF. H (057-055-061)          | 92X69X35   | 4015    | 4315                  | 4615   | 4915   | 5215                             | 5515                      | 2865   | 3055     | 3245      |
| I CONF. I (012-055-053)          | 92X115X35  | 5080    | 5455                  | 5830   | 6205   | 6580                             | 6955                      | 3525   | 3735     | 3945      |
| J CONF. J (052-050-056)          | 126X80X35  | 4545    | 4865                  | 5185   | 5505   | 5825                             | 6145                      | 3255   | 3460     | 3665      |
| K CONF. K (052-050-061)          | 126X103X35 | 5135    | 5490                  | 5845   | 6200   | 6555                             | 6910                      | 3580   | 3790     | 4000      |

Hauteur complète 35" | Hauteur de siège 19" | Hauteur devant bras 24" | Profondeur d'assise 21"  
 Total Height 35" | Seat Height 19" | Arm Height 24" | Seat Depth 21"

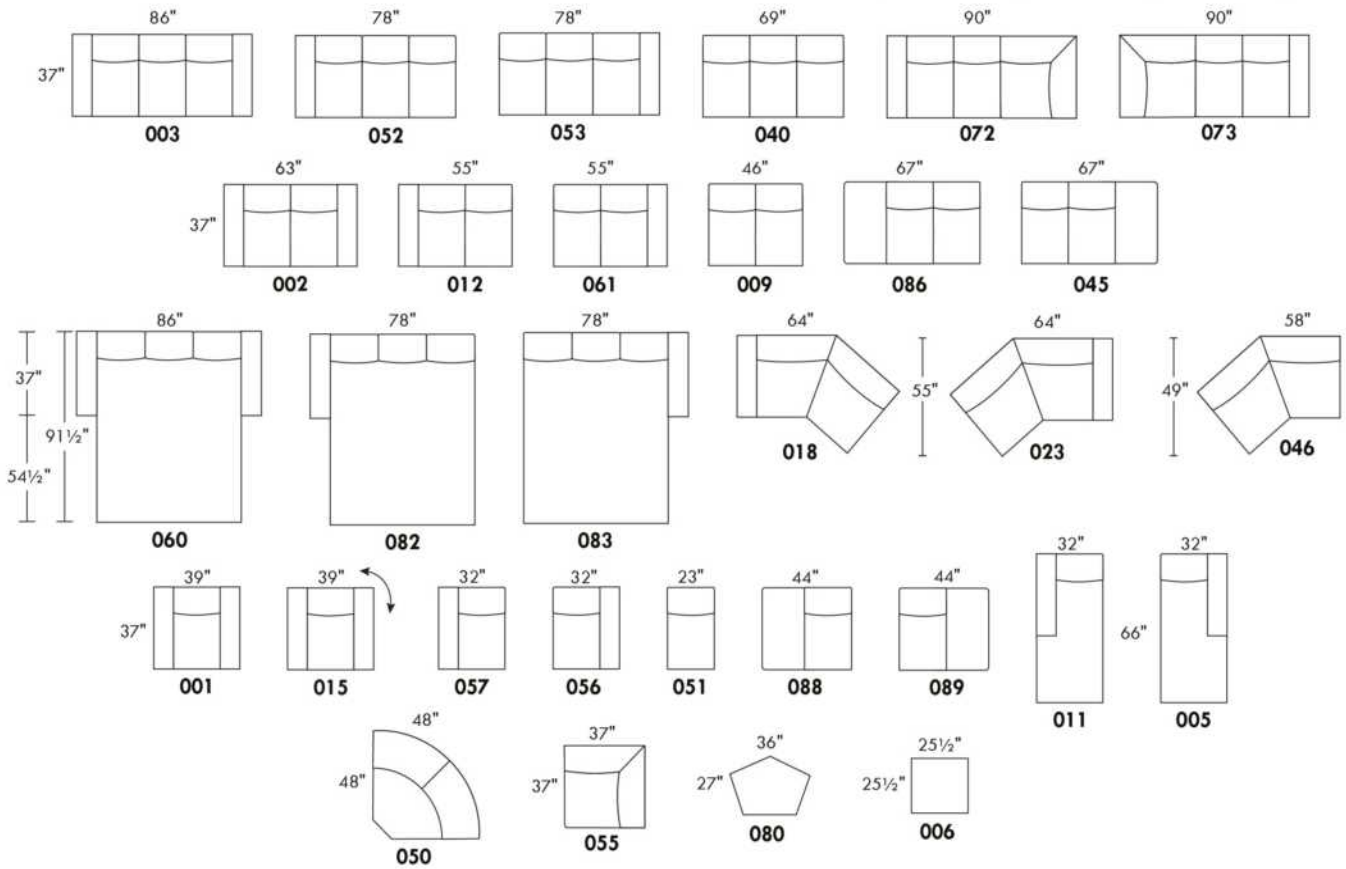

## CONFIGURATIONS

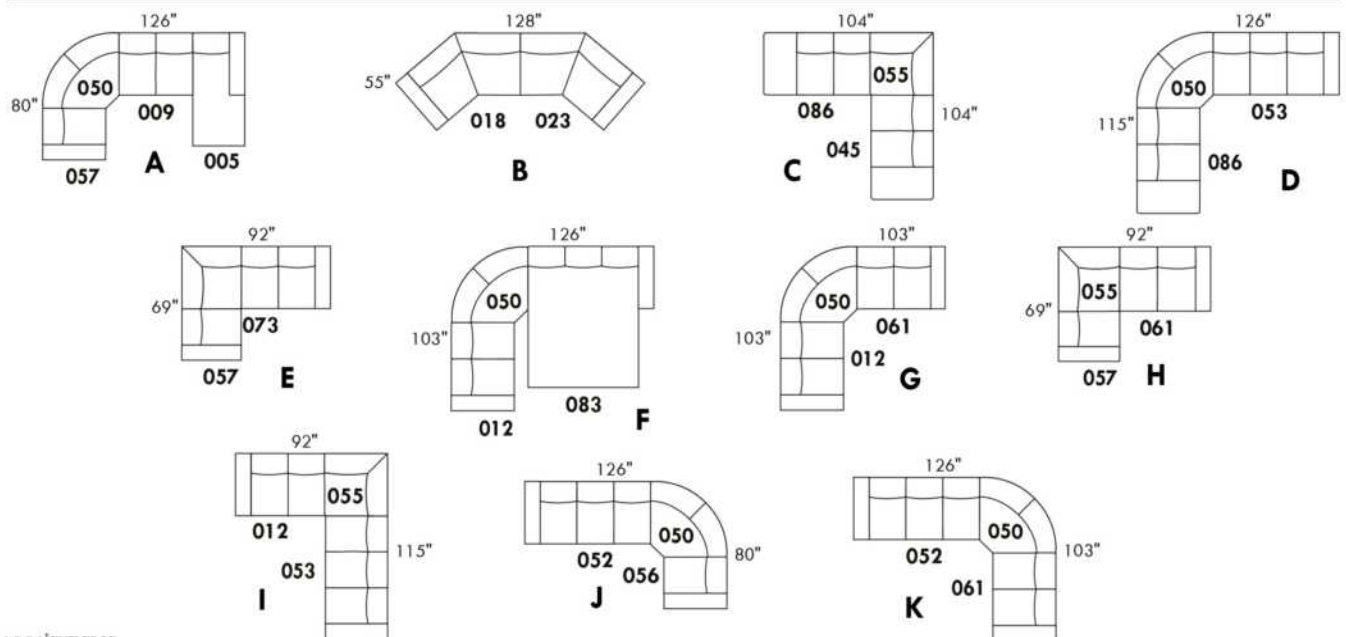

www.jaymar.ca

Toutes les dimensions indiquées sont au pouce près. Nos produits sont fabriqués à la main et des variations mineures peuvent survenir.  
 All dimensions indicated are to the nearest inch. Our product is hand-made and minor variations can occur.

## CDN Price List

### BARCELONA

Specify colour of legs LG103.

\*REMARK: Armless end pieces are not fully upholstered.

| Description                         | L x D x H | Leather |                       |  |  |                                  |                           | Fabric |          |           |
|-------------------------------------|-----------|---------|-----------------------|--|--|----------------------------------|---------------------------|--------|----------|-----------|
|                                     |           | 10      | 20<br>Madras<br>Softy | 30<br>Hugo<br>Fantasy<br>Illusion<br>Tucson<br>Utah<br>Vintage<br>Wild Laredo<br>Yukon | 40<br>Elegance<br>Princess<br>Santiago<br>Sensation<br>Sunset<br>Trina<br>Victoria | 50<br>Bull<br>Cassiope<br>Dublin | 60<br>Caress<br>Ultrasued | A      | B<br>COM | C<br>alta |
| 002 LOVESEAT                        | 72X41X35  | 2280    | 2410                  | 2540   | 2670   | 2800                             | 2930                      | 1535   | 1645     | 1755      |
| 005 LOUNGE CHAIR RIGHT ARM          | 36X67X35  | 1485    | 1575                  | 1665   | 1755   | 1845                             | 1935                      | 1320   | 1400     | 1480      |
| 009 ARMLESS LOVESEAT                | 52X41X35  | 1545    | 1680                  | 1815   | 1950   | 2085                             | 2220                      | 1330   | 1420     | 1510      |
| 011 LOUNGE CHAIR LEFT ARM           | 36X67X35  | 1485    | 1575                  | 1665   | 1755   | 1845                             | 1935                      | 1320   | 1400     | 1480      |
| 012 LOVESEAT LEFT ARM               | 62X41X35  | 1910    | 2045                  | 2180   | 2315   | 2450                             | 2585                      | 1420   | 1530     | 1640      |
| 024 SECTIONAL LOVESEAT BUMPER RIGHT | 86X41X35  | 2345    | 2480                  | 2615   | 2750   | 2885                             | 3020                      | 1740   | 1840     | 1940      |
| 040 ARMLESS SOFA                    | 78X41X35  | 2165    | 2330                  | 2495   | 2660   | 2825                             | 2990                      | 1830   | 1945     | 2060      |
| 048 SECTIONAL LOVESEAT BUMPER LEFT  | 86X41X35  | 2345    | 2480                  | 2615   | 2750   | 2885                             | 3020                      | 1740   | 1840     | 1940      |
| 051 ARMLESS CHAIR                   | 26X41X35  | 930     | 1020                  | 1110   | 1200   | 1290                             | 1380                      | 890    | 960      | 1030      |
| 052 SOFA LEFT ARM                   | 88X41X35  | 2445    | 2610                  | 2775   | 2940   | 3105                             | 3270                      | 1930   | 2045     | 2160      |
| 053 SOFA RIGHT ARM                  | 88X41X35  | 2445    | 2610                  | 2775   | 2940   | 3105                             | 3270                      | 1930   | 2045     | 2160      |
| 055 SQUARE CORNER                   | 39X39X35  | 1215    | 1305                  | 1395   | 1485   | 1575                             | 1665                      | 1200   | 1280     | 1360      |
| 056 CHAIR RIGHT ARM                 | 36X41X35  | 1275    | 1365                  | 1455   | 1545   | 1635                             | 1725                      | 980    | 1070     | 1160      |
| 057 CHAIR LEFT ARM                  | 36X41X35  | 1275    | 1365                  | 1455   | 1545   | 1635                             | 1725                      | 980    | 1070     | 1160      |
| 061 LOVESEAT RIGHT ARM              | 62X41X35  | 1910    | 2045                  | 2180   | 2315   | 2450                             | 2585                      | 1420   | 1530     | 1640      |
| 095 APARTMENT SOFA                  | 89X41X35  | 2715    | 2890                  | 3065   | 3240   | 3415                             | 3590                      | 1985   | 2100     | 2215      |
| 096 APARTMENT SOFA LEFT ARM         | 79X41X35  | 2375    | 2555                  | 2735   | 2915   | 3095                             | 3275                      | 1870   | 2000     | 2130      |
| 097 APARTMENT SOFA RIGHT ARM        | 79X41X35  | 2375    | 2555                  | 2735   | 2915   | 3095                             | 3275                      | 1870   | 2000     | 2130      |
| <b>CONFIGURATIONS</b>               |           |         |                       |  |  |                                  |                           |        |          |           |
| A CONF. A (12-24)                   | 103X86X35 | 4255    | 4525                  | 4795   | 5065   | 5335                             | 5605                      | 3160   | 3370     | 3580      |
| B CONF. B (48-61)                   | 86X103X35 | 4255    | 4525                  | 4795   | 5065   | 5335                             | 5605                      | 3160   | 3370     | 3580      |
| C CONF. C (12-05)                   | 98X67X35  | 3395    | 3620                  | 3845   | 4070   | 4295                             | 4520                      | 2740   | 2930     | 3120      |
| D CONF. D (11-61)                   | 67X98X35  | 3395    | 3620                  | 3845   | 4070   | 4295                             | 4520                      | 2740   | 2930     | 3120      |
| E CONF. E (52-24)                   | 129X86X35 | 4790    | 5090                  | 5390   | 5690   | 5990                             | 6290                      | 3670   | 3885     | 4100      |
| F CONF. F(48-53)                    | 86X129X35 | 4790    | 5090                  | 5390   | 5690   | 5990                             | 6290                      | 3670   | 3885     | 4100      |
| G CONF. G (52-05)                   | 124X67X35 | 3930    | 4185                  | 4440   | 4695   | 4950                             | 5205                      | 3250   | 3445     | 3640      |
| H CONF. H (11-53)                   | 67X124X35 | 3930    | 4185                  | 4440   | 4695   | 4950                             | 5205                      | 3250   | 3445     | 3640      |
| I CONF. I (11-09-05)                | 67X124X35 | 4515    | 4830                  | 5145   | 5460   | 5775                             | 6090                      | 3970   | 4220     | 4470      |
| J CONF. J (48-09-24)                | 86X134X35 | 6235    | 6640                  | 7045   | 7450   | 7855                             | 8260                      | 4810   | 5100     | 5390      |

## CDN Price List

### BARCELONA

| Description          | L x D x H | Leather |                       |  |  |                                  |                           | Fabric |          |           |
|----------------------|-----------|---------|-----------------------|--|--|----------------------------------|---------------------------|--------|----------|-----------|
|                      |           | 10      | 20<br>Madras<br>Softy | 30<br>Hugo<br>Fantasy<br>Illusion<br>Tucson<br>Utah<br>Vintage<br>Wild Laredo<br>Yukon | 40<br>Elegance<br>Princess<br>Santiago<br>Sensation<br>Sunset<br>Trina<br>Victoria | 50<br>Bull<br>Cassiope<br>Dublin | 60<br>Caress<br>Ultrasued | A      | B<br>COM | C<br>alta |
| K CONF. K (11-09-24) | 129X86X35 | 5375    | 5735                  | 6095   | 6455   | 6815                             | 7175                      | 4390   | 4660     | 4930      |
| L CONF. L (48-09-05) | 129X86X35 | 5375    | 5735                  | 6095   | 6455   | 6815                             | 7175                      | 4390   | 4660     | 4930      |

# BARCELONA



www.jaymar.ca

Toutes les dimensions indiquées sont au pouce près. Nos produits sont fabriqués à la main et des variations mineures peuvent survenir.  
All dimensions indicated are to the nearest inch. Our product is hand-made and minor variations can occur.

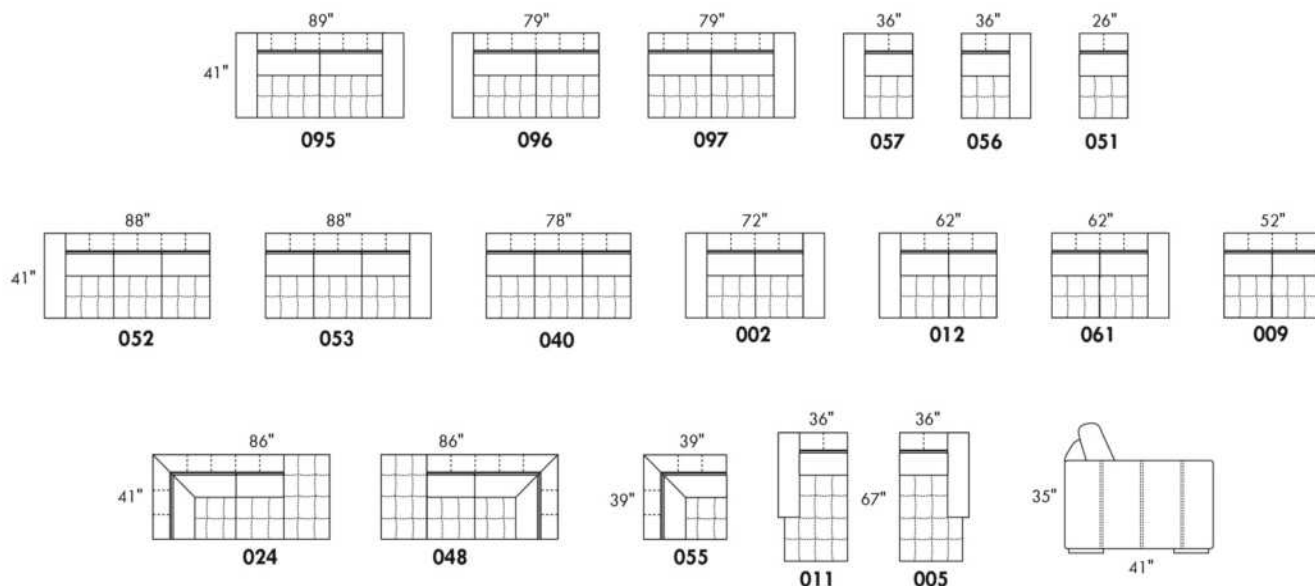

## CONFIGURATIONS

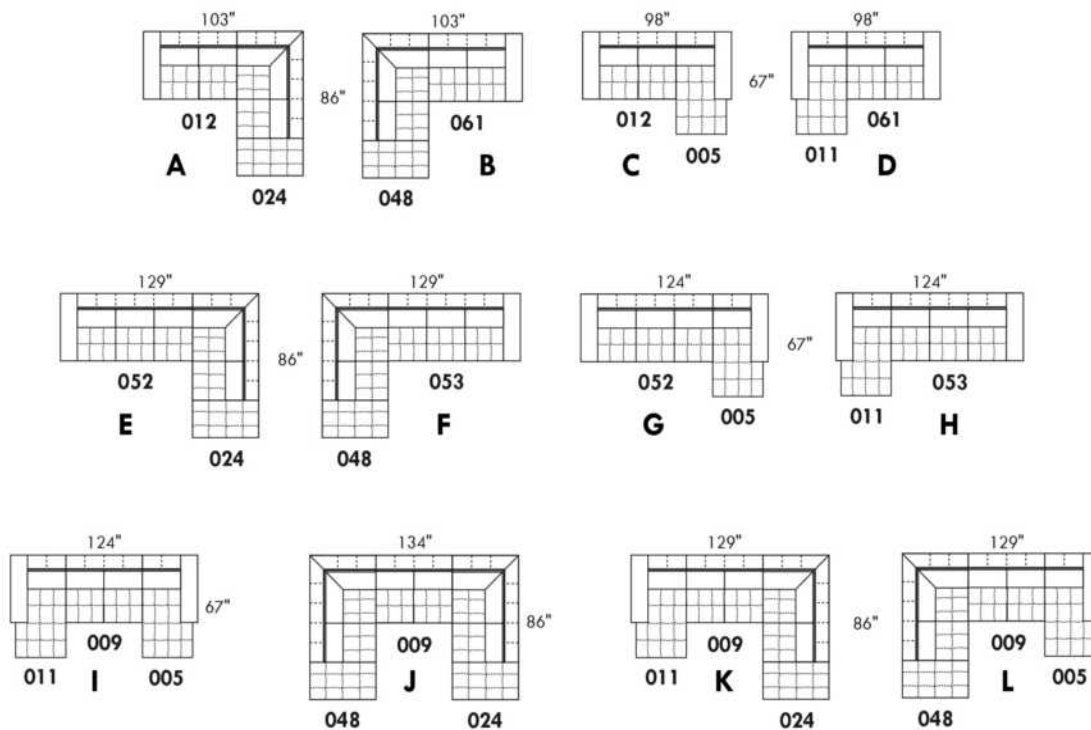

## BAZAAR

### FEATURES:

- The fashion collection offers unparalleled comfort. Each module is filled with a 100% Canadian feather mix.
- The envelopes are compartmentalized in 100% cotton casings to equally maintain the feathers in the cushions while minimizing feather leaks.
- All furniture pieces are finished on the sides and can be arranged as a sectional or as standalone pieces.
- Each item has a discreet fastening system that can be turned under the furniture.

Items #256 Large Square Ottoman & #257 Upholstered Square Table can be use as a square corner.

### BACK CUSHIONS

The back cushions (large & small) are included in the identified items. (See sketch).

You must choose the style of back cushions either: FASHION I (full width) or FASHION II (square cushion).

Note: You may not combine a Fashion I and II style cushion within the same item.

Ex: You can take a Fashion I cushion for a chair 001 & a Fashion II cushion for a square corner 055.

### Specify on your ORDER:

For each item, specify style (I or II) for the cushions.

You must also specify the cover of the base as well as the cushions.

Ex.: Item 095 base: Cover #1. Cushions Fashion II 833: cover #2 & 834: #3.

Leg: LG201 metal (chrome or black); specify colour.

Upholstered Tables items 077, 257 & 258: Specify color of wood table top.

EXTRA Back Cushions: Specify code, cover, color and quantity.

| Description                          | L x D x H   | Leather |                       |  |  |                                  |                           | Fabric |          |           |
|--------------------------------------|-------------|---------|-----------------------|--|--|----------------------------------|---------------------------|--------|----------|-----------|
|                                      |             | 10      | 20<br>Madras<br>Softy | 30<br>Hugo<br>Fantasy<br>Illusion<br>Tucson<br>Utah<br>Vintage<br>Wild Laredo<br>Yukon | 40<br>Elegance<br>Princess<br>Santiago<br>Sensation<br>Sunset<br>Trina<br>Victoria | 50<br>Bull<br>Cassiope<br>Dublin | 60<br>Caress<br>Ultrasued | A      | B<br>COM | C<br>alta |
| 006 OTTOMAN                          | 36x30x18    |         |                       |  |  |                                  |                           | 650    | 670      | 690       |
| 017 DOUBLE CHAIR                     | 57x44x30/35 |         |                       |  |  |                                  |                           | 1340   | 1390     | 1440      |
| 021 APARTMENT SOFA NO ARM            | 71x44x30/35 |         |                       |  |  |                                  |                           | 1750   | 1825     | 1900      |
| 055 SQUARE CORNER                    | 52x52x30/35 |         |                       |  |  |                                  |                           | 1545   | 1595     | 1645      |
| 077 UPHOLSTERED TABLE                | 36x44x16    |         |                       |  |  |                                  |                           | 900    | 925      | 950       |
| 095 APARTMENT SOFA                   | 93x44x30/35 |         |                       |  |  |                                  |                           | 1970   | 2050     | 2130      |
| 096 APARTMENT SOFA LEFT ARM          | 82x44x30/35 |         |                       |  |  |                                  |                           | 1855   | 1945     | 2035      |
| 097 APARTMENT SOFA RIGHT ARM         | 82x44x30/35 |         |                       |  |  |                                  |                           | 1855   | 1945     | 2035      |
| 115 LARGE OTTOMAN                    | 36x44x18    |         |                       |  |  |                                  |                           | 785    | 820      | 855       |
| 173 DOUBLE LOUNGE CHAIR LEFT ARM     | 41x78x30/35 |         |                       |  |  |                                  |                           | 1655   | 1710     | 1765      |
| 174 DOUBLE LOUNGE CHAIR RIGHT ARM    | 41x78x30/35 |         |                       |  |  |                                  |                           | 1655   | 1710     | 1765      |
| 175 DOUBLE CHAIR LEFT ARM            | 46x44x30/35 |         |                       |  |  |                                  |                           | 1235   | 1285     | 1335      |
| 176 DOUBLE CHAIR RIGHT ARM           | 46x44x30/35 |         |                       |  |  |                                  |                           | 1235   | 1285     | 1335      |
| 177 ARMLESS DOUBLE CHAIR             | 36x44x30/35 |         |                       |  |  |                                  |                           | 1135   | 1165     | 1195      |
| 178 ARMLESS DOUBLE CHAIR BUMPER LEFT | 60x44x30/35 |         |                       |  |  |                                  |                           | 1480   | 1525     | 1570      |

## BAZAAR

### FEATURES:

- The fashion collection offers unparalleled comfort. Each module is filled with a 100% Canadian feather mix.
- The envelopes are compartmentalized in 100% cotton casings to equally maintain the feathers in the cushions while minimizing feather leaks.
- All furniture pieces are finished on the sides and can be arranged as a sectional or as standalone pieces.
- Each item has a discreet fastening system that can be turned under the furniture.

Items #256 Large Square Ottoman & #257 Upholstered Square Table can be use as a square corner.

### BACK CUSHIONS

The back cushions (large & small) are included in the identified items. (See sketch).

You must choose the style of back cushions either: FASHION I (full width) or FASHION II (square cushion).

Note: You may not combine a Fashion I and II style cushion within the same item.

Ex: You can take a Fashion I cushion for a chair 001 & a Fashion II cushion for a square corner 055.

### Specify on your ORDER:

For each item, specify style (I or II) for the cushions.

You must also specify the cover of the base as well as the cushions.

Ex.: Item 095 base: Cover #1. Cushions Fashion II 833: cover #2 & 834: #3.

Leg: LG201 metal (chrome or black); specify colour.

Upholstered Tables items 077, 257 & 258: Specify color of wood table top.

EXTRA Back Cushions: Specify code, cover, color and quantity.

| Description                           | L x D x H     | Leather |                       |  |  |                                  |                           | Fabric |          |           |
|---------------------------------------|---------------|---------|-----------------------|--|--|----------------------------------|---------------------------|--------|----------|-----------|
|                                       |               | 10      | 20<br>Madras<br>Softy | 30<br>Hugo<br>Fantasy<br>Illusion<br>Tucson<br>Utah<br>Vintage<br>Wild Laredo<br>Yukon | 40<br>Elegance<br>Princess<br>Santiago<br>Sensation<br>Sunset<br>Trina<br>Victoria | 50<br>Bull<br>Cassiope<br>Dublin | 60<br>Caress<br>Ultrasued | A      | B<br>COM | C<br>alta |
| 179 ARMLESS DOUBLE CHAIR BUMPER RIGHT | 60x44x30/35   |         |                       |  |  |                                  |                           | 1480   | 1525     | 1570      |
| 256 LARGE SQUARE OTTOMAN              | 44x44x18      |         |                       |  |  |                                  |                           | 955    | 985      | 1015      |
| 257 UPHOLSTERED SQUARE TABLE          | 44x44x16      |         |                       |  |  |                                  |                           | 1155   | 1185     | 1215      |
| 258 SMALL UPHOLSTERED TABLE           | 15x44x16      |         |                       |  |  |                                  |                           | 600    | 615      | 630       |
| 831 F I: LARGE BACK CUSHION 34X19     | 34x7x19       |         |                       |  |  |                                  |                           | 105    | 105      | 105       |
| 832 F 1: SMALL BACK CUSHION 24X10     | 24x6x10       |         |                       |  |  |                                  |                           | 85     | 85       | 85        |
| 833 F II: LARGE BACK CUSHION 26X19    | 26x7x19       |         |                       |  |  |                                  |                           | 105    | 105      | 105       |
| 834 F II: SMALL BACK CUSHION 16X16    | 16x6x16       |         |                       |  |  |                                  |                           | 85     | 85       | 85        |
| <b>CONFIGURATIONS</b>                 |               |         |                       |  |  |                                  |                           |        |          |           |
| A CONFIG (173-097) + (006)            | 123X78X30/35  |         |                       |  |  |                                  |                           | 4160   | 4325     | 4490      |
| B CONFIG (096-055-176) + (077)        | 98X134X30/35  |         |                       |  |  |                                  |                           | 5535   | 5750     | 5965      |
| C CONFIG (175-115-055-097)            | 134X134X30/35 |         |                       |  |  |                                  |                           | 5420   | 5645     | 5870      |
| D CONFIG (173-177-055-097)            | 129X134X30/35 |         |                       |  |  |                                  |                           | 6190   | 6415     | 6640      |



## FASHION COLLECTION

### FASHION I

COUSSINS PLEINE LARGEUR  
 FULL BACK CUSHIONS

831 34 x 7 x 19  
 832 24 x 6 x 10



### FASHION II

COUSSINS CARRÉS - DOS APPARENT  
 SQUARE CUSHIONS - VISIBLE BACK

833 26 x 7 x 19  
 834 16 x 6 x 16

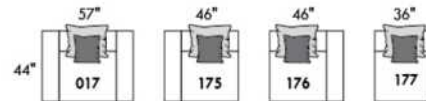
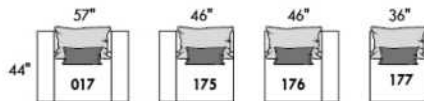
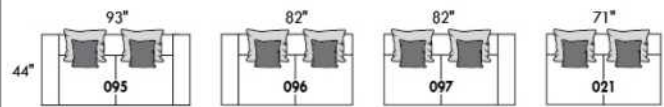
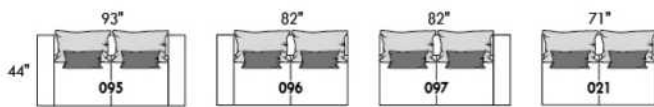

Mélanger & agencer!  
 Mix & Match!

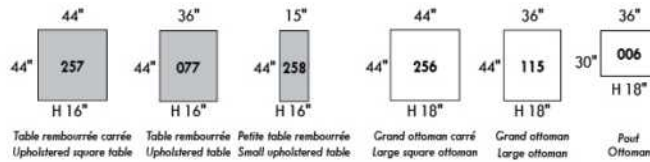
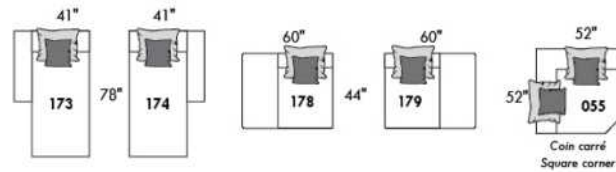
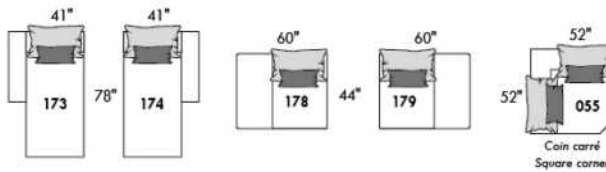

### Populaires | Popular CONFIGURATIONS

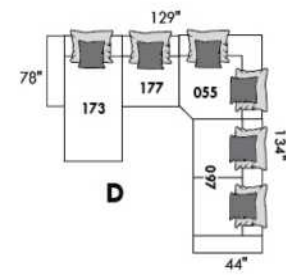
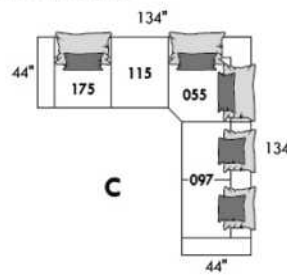
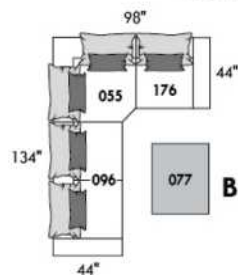
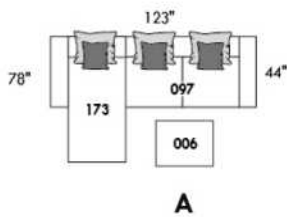

www.jaymar.ca

Toutes les dimensions indiquées sont au pouce près. Nos produits sont fabriqués à la main et des variations mineures peuvent survenir.  
 All dimensions indicated are to the nearest inch. Our product is hand-made and minor variations can occur.





### BAZINI

Specify colour of legs LG107.

PLAIN FABRIC RECOMMENDED.  
Cushions non reversable.

COMBO #1: Cover #2 on backs & seats. PRICE: See "Product Knowledge" booklet.

COMBO #2: Cover #2 SEATS in LEATHER ONLY; Grade 10 to 30 add \$60 per seat cushion. Grade 40 to 60 add \$90 per seat cushion. Lounge = 2 seats.

| Description                    | L x D x H  | Leather |                       |  |  |                                  |                           | Fabric |          |           |
|--------------------------------|------------|---------|-----------------------|--|--|----------------------------------|---------------------------|--------|----------|-----------|
|                                |            | 10      | 20<br>Madras<br>Softy | 30<br>Hugo<br>Fantasy<br>Illusion<br>Tucson<br>Utah<br>Vintage<br>Wild Laredo<br>Yukon | 40<br>Elegance<br>Princess<br>Santiago<br>Sensation<br>Sunset<br>Trina<br>Victoria | 50<br>Bull<br>Cassiope<br>Dublin | 60<br>Caress<br>Ultrasued | A      | B<br>COM | C<br>alta |
| 002 LOVESEAT                   | 66X41X34   | 2230    | 2335                  | 2440   | 2545   | 2650                             | 2755                      | 1450   | 1540     | 1630      |
| 005 LOUNGE CHAIR RIGHT ARM     | 42X70X34   | 1880    | 1980                  | 2080   | 2180   | 2280                             | 2380                      | 1390   | 1470     | 1550      |
| 006 OTTOMAN                    | 35X24X17   | 715     | 740                   | 765  | 790  | 815                              | 840                       | 535    | 545      | 555       |
| 011 LOUNGE CHAIR LEFT ARM      | 42X70X34   | 1880    | 1980                  | 2080   | 2180   | 2280                             | 2380                      | 1390   | 1470     | 1550      |
| 017 DOUBLE CHAIR               | 49X41X34   | 1695    | 1790                  | 1885   | 1980   | 2075                             | 2170                      | 1230   | 1295     | 1360      |
| 021 APARTMENT SOFA NO ARM      | 70X41X34   | 2065    | 2200                  | 2335   | 2470   | 2605                             | 2740                      | 1660   | 1765     | 1870      |
| 051 ARMLESS CHAIR              | 35X41X34   | 1115    | 1190                  | 1265   | 1340   | 1415                             | 1490                      | 1095   | 1145     | 1195      |
| 055 SQUARE CORNER              | 45X45X34   | 1195    | 1265                  | 1335   | 1405   | 1475                             | 1545                      | 1095   | 1145     | 1195      |
| 056 CHAIR RIGHT ARM            | 42X41X34   | 1400    | 1490                  | 1580   | 1670   | 1760                             | 1850                      | 1150   | 1205     | 1260      |
| 057 CHAIR LEFT ARM             | 42X41X34   | 1400    | 1490                  | 1580   | 1670   | 1760                             | 1850                      | 1150   | 1205     | 1260      |
| 088 ARMLESS CHAIR BUMPER LEFT  | 56X41X34   | 1460    | 1560                  | 1660   | 1760   | 1860                             | 1960                      | 1170   | 1225     | 1280      |
| 089 ARMLESS CHAIR BUMPER RIGHT | 56X41X34   | 1460    | 1560                  | 1660   | 1760   | 1860                             | 1960                      | 1170   | 1225     | 1280      |
| 095 APARTMENT SOFA             | 84X41X34   | 2675    | 2810                  | 2945   | 3080   | 3215                             | 3350                      | 1850   | 1960     | 2070      |
| 096 APARTMENT SOFA LEFT ARM    | 77X41X34   | 2355    | 2490                  | 2625   | 2760   | 2895                             | 3030                      | 1755   | 1860     | 1965      |
| 097 APARTMENT SOFA RIGHT ARM   | 77X41X34   | 2355    | 2490                  | 2625   | 2760   | 2895                             | 3030                      | 1755   | 1860     | 1965      |
| <b>CONFIGURATIONS</b>          |            |         |                       |  |  |                                  |                           |        |          |           |
| A CONF. A (011-097)            | 119X70X34  | 4235    | 4470                  | 4705   | 4940   | 5175                             | 5410                      | 3145   | 3330     | 3515      |
| B CONF. B (088-055-089)        | 101X101X34 | 4115    | 4385                  | 4655   | 4925   | 5195                             | 5465                      | 3435   | 3595     | 3755      |
| C CONF. C (096-055-056)        | 87X122X34  | 4950    | 5245                  | 5540   | 5835   | 6130                             | 6425                      | 4000   | 4210     | 4420      |
| D CONF. D (011-051-055-089)    | 122X101X34 | 5650    | 5995                  | 6340   | 6685   | 7030                             | 7375                      | 4750   | 4985     | 5220      |

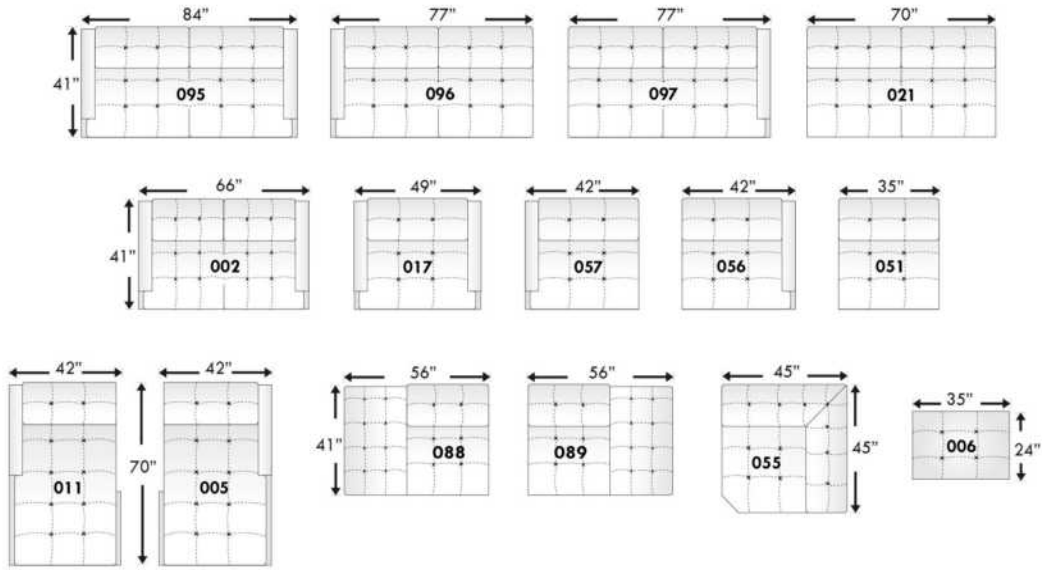

## Configurations

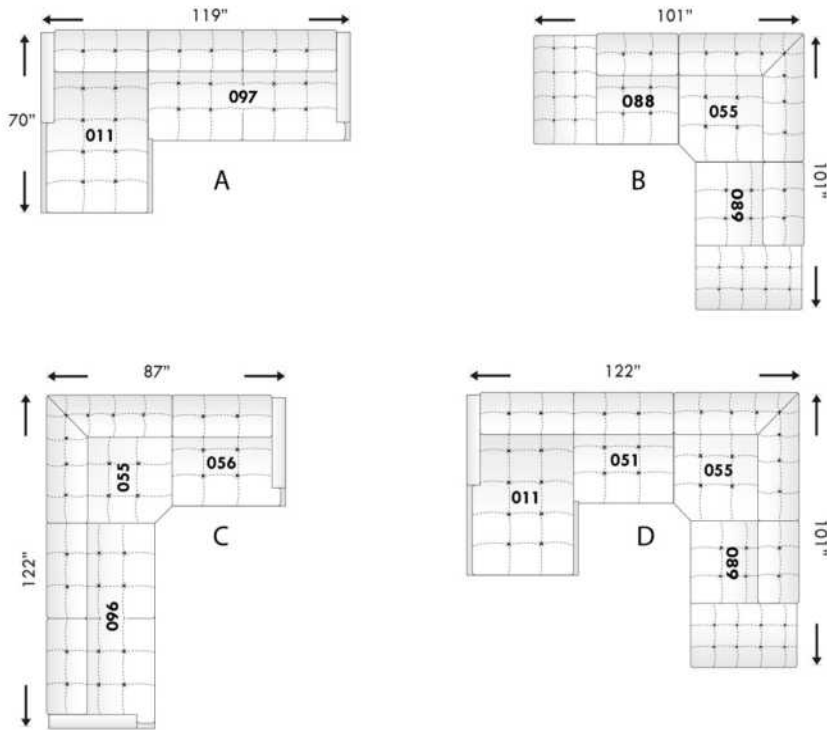

Toutes les dimensions indiquées sont au pouce près. Nos produits sont fabriqués à la main et des variations mineures peuvent survenir.  
 All dimensions indicated are to the nearest inch. Our product is hand-made and minor variations can occur.

RZ012-02

## BERLIN

### FEATURES:

- Manual adjustable headrest on all items (2 on square corner & stationary on wedge).
- \*Wall hugger power recliners with full footrest (manual n/a).
- Power recliner lounge chair (manual n/a) with power headrest in option. Wall clearance 8" & front 5".
- Seat cushions with shaped foam + 1" layer of memory foam on top.
- Stitching: Small thread in fabric & large flat thread in leather.
- \*Excludes 043 & 163 chairs: Wall clearance 16"

Note: 2 recliner seats separated by a corner can not be opened at the same time. No recliner seats beside #155 Small Square Corner.

### OPTIONS

- Battery Pack: Add \$160/ea.
- \*Motorized headrest:: Add \$160 ea. (\*N/A on stationary items).
- Foam: Extra ferme ajoutez \$15/siège.
- Choice of Large or Small 6" Arm: Legs on LARGE arm: LG187 wood or LG189 metal (Black or Chrome). SMALL Arm: LG195 wood or LG196 metal (Black or Chrome). Specify colour.
- Seat Depth: 20" or \*22". \*22" seat depth N/A on chairs 043 & 163.
- 043 & 163 Chairs: with wood base (specify colour).

### HOME THEATRE Configurations

For Accessories, Cup holders & Configuration details, see Optima Home Theatre page attached.

Accessory Dock : \$35 ea.

Cup Holders: Metal: \$25 ea. | LED lighted Cup Holder: \$25 ea. | \*LED lighted Cup Holder with (1 or 2 motor) controls: \$40 ea.

\*LED Light strip under seat: \$25/seat.

| Description                        | L x D x H   | Leather |                       |  |  |                                  |                           | Fabric |          |           |
|------------------------------------|-------------|---------|-----------------------|--|--|----------------------------------|---------------------------|--------|----------|-----------|
|                                    |             | 10      | 20<br>Madras<br>Softy | 30<br>Hugo<br>Fantasy<br>Illusion<br>Tucson<br>Utah<br>Vintage<br>Wild Laredo<br>Yukon | 40<br>Elegance<br>Princess<br>Santiago<br>Sensation<br>Sunset<br>Trina<br>Victoria | 50<br>Bull<br>Cassiope<br>Dublin | 60<br>Caress<br>Ultrasued | A      | B<br>COM | C<br>alta |
| 001 CHAIR                          | 45x40x33/40 | 1890    | 1980                  | 2070   | 2160   | 2250                             | 2340                      | 1535   | 1580     | 1625      |
| 002 LOVESEAT                       | 68x40x33/40 | 2700    | 2815                  | 2930   | 3045   | 3160                             | 3275                      | 2175   | 2250     | 2325      |
| 003 SOFA                           | 92x40x33/40 | 3265    | 3415                  | 3565   | 3715   | 3865                             | 4015                      | 2625   | 2715     | 2805      |
| 005 LOUNGE CHAIR RIGHT ARM         | 35x62x33/40 | 1765    | 1830                  | 1895   | 1960   | 2025                             | 2090                      | 1410   | 1470     | 1530      |
| 009 ARMLESS LOVESEAT               | 47x40x33/40 | 1895    | 1965                  | 2035   | 2105   | 2175                             | 2245                      | 1490   | 1570     | 1650      |
| 011 LOUNGE CHAIR LEFT ARM          | 35x62x33/40 | 1765    | 1830                  | 1895   | 1960   | 2025                             | 2090                      | 1410   | 1470     | 1530      |
| 012 LOVESEAT LEFT ARM              | 58x40x33/40 | 2320    | 2420                  | 2520   | 2620   | 2720                             | 2820                      | 1850   | 1925     | 2000      |
| 017 DOUBLE CHAIR                   | 52x40x33/40 | 1980    | 2080                  | 2180   | 2280   | 2380                             | 2480                      | 1600   | 1660     | 1720      |
| 021 APARTMENT SOFA NO ARM          | 61x40x33/40 | 2140    | 2240                  | 2340   | 2440   | 2540                             | 2640                      | 1670   | 1755     | 1840      |
| 040 ARMLESS SOFA                   | 71x40x33/40 | 2450    | 2565                  | 2680   | 2795   | 2910                             | 3025                      | 1950   | 2040     | 2130      |
| 041 RECLINING CHAIR LEFT ARM       | 35x40x33/40 | 1885    | 1960                  | 2035   | 2110   | 2185                             | 2260                      | 1605   | 1640     | 1675      |
| 042 RECLINING CHAIR RIGHT ARM      | 35x40x33/40 | 1885    | 1960                  | 2035   | 2110   | 2185                             | 2260                      | 1605   | 1640     | 1675      |
| 043 SWIVEL ROCKING RECLINING CHAIR | 30x34x42    | 2235    | 2345                  | 2455   | 2565   | 2675                             | 2785                      | 1875   | 1920     | 1965      |
| 044 RECLINER CHAIR                 | 45x40x33/40 | 2275    | 2365                  | 2455   | 2545   | 2635                             | 2725                      | 1920   | 1970     | 2020      |
| 045 ARMLESS LOVESEAT BUMPER RIGHT  | 68x40x33/40 | 2245    | 2340                  | 2435   | 2530   | 2625                             | 2720                      | 1785   | 1850     | 1915      |
| 050 WEDGE                          | 49x49x33    | 1645    | 1745                  | 1845   | 1945   | 2045                             | 2145                      | 1210   | 1270     | 1330      |

## BERLIN

### FEATURES:

- Manual adjustable headrest on all items (2 on square corner & stationary on wedge).
- \*Wall hugger power recliners with full footrest (manual n/a).
- Power recliner lounge chair (manual n/a) with power headrest in option. Wall clearance 8" & front 5".
- Seat cushions with shaped foam + 1" layer of memory foam on top.
- Stitching: Small thread in fabric & large flat thread in leather.
- \*Excludes 043 & 163 chairs: Wall clearance 16"

Note: 2 recliner seats separated by a corner can not be opened at the same time. No recliner seats beside #155 Small Square Corner.

### OPTIONS

- Battery Pack: Add \$160/ea.
- \*Motorized headrest:: Add \$160 ea. (\*N/A on stationary items).
- Foam: Extra ferme ajoutez \$15/siège.
- Choice of Large or Small 6" Arm: Legs on LARGE arm: LG187 wood or LG189 metal (Black or Chrome). SMALL Arm: LG195 wood or LG196 metal (Black or Chrome). Specify colour.
- Seat Depth: 20" or \*22". \*22" seat depth N/A on chairs 043 & 163.
- 043 & 163 Chairs: with wood base (specify colour).

### HOME THEATRE Configurations

For Accessories, Cup holders & Configuration details, see Optima Home Theatre page attached.

Accessory Dock : \$35 ea.

Cup Holders: Metal: \$25 ea. | LED lighted Cup Holder: \$25 ea. | \*LED lighted Cup Holder with (1 or 2 motor) controls: \$40 ea.

\*LED Light strip under seat: \$25/seat.

| Description                      | L x D x H     | Leather |                       |  |  |                                  |                            | Fabric |          |           |
|----------------------------------|---------------|---------|-----------------------|--|--|----------------------------------|----------------------------|--------|----------|-----------|
|                                  |               | 10      | 20<br>Madras<br>Softy | 30<br>Hugo<br>Fantasy<br>Illusion<br>Tucson<br>Utah<br>Vintage<br>Wild Laredo<br>Yukon | 40<br>Elegance<br>Princess<br>Santiago<br>Sensation<br>Sunset<br>Trina<br>Victoria | 50<br>Bull<br>Cassiope<br>Dublin | 60<br>Caresse<br>Ultrasued | A      | B<br>COM | C<br>alta |
| 051 ARMLESS CHAIR                | 23,5x40x33/40 | 1085    | 1135                  | 1185   | 1235   | 1285                             | 1335                       | 845    | 900      | 955       |
| 052 SOFA LEFT ARM                | 82x40x33/40   | 2870    | 3005                  | 3140   | 3275   | 3410                             | 3545                       | 2290   | 2385     | 2480      |
| 053 SOFA RIGHT ARM               | 82x40x33/40   | 2870    | 3005                  | 3140   | 3275   | 3410                             | 3545                       | 2290   | 2385     | 2480      |
| 055 SQUARE CORNER                | 44x44x33/40   | 1915    | 2010                  | 2105   | 2200   | 2295                             | 2390                       | 1510   | 1565     | 1620      |
| 056 CHAIR RIGHT ARM              | 35x40x33/40   | 1510    | 1575                  | 1640   | 1705   | 1770                             | 1835                       | 1200   | 1260     | 1320      |
| 057 CHAIR LEFT ARM               | 35x40x33/40   | 1510    | 1575                  | 1640   | 1705   | 1770                             | 1835                       | 1200   | 1260     | 1320      |
| 061 LOVESEAT RIGHT ARM           | 58x40x33/40   | 2320    | 2420                  | 2520   | 2620   | 2720                             | 2820                       | 1850   | 1925     | 2000      |
| 071 ARMLESS RECLINING CHAIR      | 23,5x40x33/40 | 1470    | 1525                  | 1580   | 1635   | 1690                             | 1745                       | 1250   | 1310     | 1370      |
| 086 ARMLESS LOVESEAT BUMPER LEFT | 68x40x33/40   | 2245    | 2340                  | 2435   | 2530   | 2625                             | 2720                       | 1785   | 1850     | 1915      |
| 088 ARMLESS CHAIR BUMPER LEFT    | 45x40x33/40   | 1440    | 1535                  | 1630   | 1725   | 1820                             | 1915                       | 1130   | 1165     | 1200      |
| 089 ARMLESS CHAIR BUMPER RIGHT   | 45x40x33/40   | 1440    | 1535                  | 1630   | 1725   | 1820                             | 1915                       | 1130   | 1165     | 1200      |
| 095 APARTMENT SOFA               | 82x40x33/40   | 2940    | 3085                  | 3230   | 3375   | 3520                             | 3665                       | 2350   | 2445     | 2540      |
| 096 APARTMENT SOFA LEFT ARM      | 72x40x33/40   | 2570    | 2680                  | 2790   | 2900   | 3010                             | 3120                       | 2020   | 2110     | 2200      |
| 097 APARTMENT SOFA RIGHT ARM     | 72x40x33/40   | 2570    | 2680                  | 2790   | 2900   | 3010                             | 3120                       | 2020   | 2110     | 2200      |
| 124 STORAGE OTTOMAN              | 30x22x17      | 745     | 765                   | 785  | 805  | 825                              | 845                        | 650    | 670      | 690       |
| 138 STRAIGHT ARM                 | 9.25x36x24    | 415     | 450                   | 485  | 520  | 555                              | 590                        | 350    | 365      | 380       |

## BERLIN

### FEATURES:

- Manual adjustable headrest on all items (2 on square corner & stationary on wedge).
- \*Wall hugger power recliners with full footrest (manual n/a).
- Power recliner lounge chair (manual n/a) with power headrest in option. Wall clearance 8" & front 5".
- Seat cushions with shaped foam + 1" layer of memory foam on top.
- Stitching: Small thread in fabric & large flat thread in leather.
- \*Excludes 043 & 163 chairs: Wall clearance 16"

Note: 2 recliner seats separated by a corner can not be opened at the same time. No recliner seats beside #155 Small Square Corner.

### OPTIONS

- Battery Pack: Add \$160/ea.
- \*Motorized headrest:: Add \$160 ea. (\*N/A on stationary items).
- Foam: Extra ferme ajoutez \$15/siège.
- Choice of Large or Small 6" Arm: Legs on LARGE arm: LG187 wood or LG189 metal (Black or Chrome). SMALL Arm: LG195 wood or LG196 metal (Black or Chrome). Specify colour.
- Seat Depth: 20" or \*22". \*22" seat depth N/A on chairs 043 & 163.
- 043 & 163 Chairs: with wood base (specify colour).

### HOME THEATRE Configurations

For Accessories, Cup holders & Configuration details, see Optima Home Theatre page attached.

Accessory Dock : \$35 ea.

Cup Holders: Metal: \$25 ea. | LED lighted Cup Holder: \$25 ea. | \*LED lighted Cup Holder with (1 or 2 motor) controls: \$40 ea.

\*LED Light strip under seat: \$25/seat.

| Description                            | L x D x H     | Leather |                       |  |  |                                  |                           | Fabric |          |           |
|--|---------------|---------|-----------------------|--|--|----------------------------------|---------------------------|--------|----------|-----------|
|  |               | 10      | 20<br>Madras<br>Softy | 30<br>Hugo<br>Fantasy<br>Illusion<br>Tucson<br>Utah<br>Vintage<br>Wild Laredo<br>Yukon | 40<br>Elegance<br>Princess<br>Santiago<br>Sensation<br>Sunset<br>Trina<br>Victoria | 50<br>Bull<br>Cassiope<br>Dublin | 60<br>Caress<br>Ultrasued | A      | B<br>COM | C<br>alta |
| 155 SMALL SQUARE CORNER                | 40x40x33/40   | 1915    | 2010                  | 2105   | 2200   | 2295                             | 2390                      | 1510   | 1565     | 1620      |
| 159 WEDGE STORAGE                      | 11/27x36x24   | 745     | 775                   | 805  | 835  | 865                              | 895                       | 585    | 600      | 615       |
| 160 STRAIGHT STORAGE                   | 11x36x24      | 720     | 745                   | 770  | 795  | 820                              | 845                       | 550    | 570      | 590       |
| 163 DBL SWIVEL ROCKING RECLINER CHAIR  | 33x34x42      | 2290    | 2410                  | 2530   | 2650   | 2770                             | 2890                      | 1880   | 1930     | 1980      |
| 165 DOUBLE RECLINING CHAIR             | 52x40x33/40   | 2375    | 2475                  | 2575   | 2675   | 2775                             | 2875                      | 2000   | 2065     | 2130      |
| 167 APARTMENT SOFA NO ARM BUMPER LEFT  | 82x40x33/40   | 2490    | 2620                  | 2750   | 2880   | 3010                             | 3140                      | 1960   | 2045     | 2130      |
| 168 APARTMENT SOFA NO ARM BUMPER RIGHT | 82x40x33/40   | 2490    | 2620                  | 2750   | 2880   | 3010                             | 3140                      | 1960   | 2045     | 2130      |
| 169 DOUBLE RECLINING CHAIR LEFT ARM    | 42x40x33/40   | 1990    | 2070                  | 2150   | 2230   | 2310                             | 2390                      | 1670   | 1750     | 1830      |
| 170 DOUBLE RECLINING CHAIR RIGHT ARM   | 42x40x33/40   | 1990    | 2070                  | 2150   | 2230   | 2310                             | 2390                      | 1670   | 1750     | 1830      |
| 171 ARMLESS DOUBLE RECLINING CHAIR     | 30,5x40x33/40 | 1575    | 1625                  | 1675   | 1725   | 1775                             | 1825                      | 1320   | 1380     | 1440      |
| 173 DOUBLE LOUNGE CHAIR LEFT ARM       | 42x62x33/40   | 1915    | 2005                  | 2095   | 2185   | 2275                             | 2365                      | 1535   | 1615     | 1695      |
| 174 DOUBLE LOUNGE CHAIR RIGHT ARM      | 42x62x33/40   | 1915    | 2005                  | 2095   | 2185   | 2275                             | 2365                      | 1535   | 1615     | 1695      |
| 175 DOUBLE CHAIR LEFT ARM              | 42x40x33/40   | 1590    | 1680                  | 1770   | 1860   | 1950                             | 2040                      | 1285   | 1350     | 1415      |
| 176 DOUBLE CHAIR RIGHT ARM             | 42x40x33/40   | 1590    | 1680                  | 1770   | 1860   | 1950                             | 2040                      | 1285   | 1350     | 1415      |
| 177 ARMLESS DOUBLE CHAIR               | 30,5x40x33/40 | 1185    | 1250                  | 1315   | 1380   | 1445                             | 1510                      | 915    | 970      | 1025      |
| 178 ARMLESS DOUBLE CHAIR BUMPER LEFT   | 52x40x33/40   | 1545    | 1625                  | 1705   | 1785   | 1865                             | 1945                      | 1230   | 1290     | 1350      |

## BERLIN

**FEATURES:**

- Manual adjustable headrest on all items (2 on square corner & stationary on wedge).
- \*Wall hugger power recliners with full footrest (manual n/a).
- Power recliner lounge chair (manual n/a) with power headrest in option. Wall clearance 8" & front 5".
- Seat cushions with shaped foam + 1" layer of memory foam on top.
- Stitching: Small thread in fabric & large flat thread in leather.
- \*Excludes 043 & 163 chairs: Wall clearance 16"

Note: 2 recliner seats separated by a corner can not be opened at the same time. No recliner seats beside #155 Small Square Corner.

**OPTIONS**

- Battery Pack: Add \$160/ea.
- \*Motorized headrest:: Add \$160 ea. (\*N/A on stationary items).
- Foam: Extra ferme ajoutez \$15/siège.
- Choice of Large or Small 6" Arm: Legs on LARGE arm: LG187 wood or LG189 metal (Black or Chrome). SMALL Arm: LG195 wood or LG196 metal (Black or Chrome). Specify colour.
- Seat Depth: 20" or \*22". \*22" seat depth N/A on chairs 043 & 163.
- 043 & 163 Chairs: with wood base (specify colour).

**HOME THEATRE Configurations**

For Accessories, Cup holders & Configuration details, see Optima Home Theatre page attached.

Accessory Dock : \$35 ea.

Cup Holders: Metal: \$25 ea. | LED lighted Cup Holder: \$25 ea. | \*LED lighted Cup Holder with (1 or 2 motor) controls: \$40 ea.

\*LED Light strip under seat: \$25/seat.

| Description                            | L x D x H       | Leather |                       |  |  |                                  |                           | Fabric |          |           |
|--|-----------------|---------|-----------------------|--|--|----------------------------------|---------------------------|--------|----------|-----------|
|  |                 | 10      | 20<br>Madras<br>Softy | 30<br>Hugo<br>Fantasy<br>Illusion<br>Tucson<br>Utah<br>Vintage<br>Wild Laredo<br>Yukon | 40<br>Elegance<br>Princess<br>Santiago<br>Sensation<br>Sunset<br>Trina<br>Victoria | 50<br>Bull<br>Cassiope<br>Dublin | 60<br>Caress<br>Ultrasued | A      | B<br>COM | C<br>alta |
| 179 ARMLESS DOUBLE CHAIR BUMPER RIGHT  | 52x40x33/40     | 1545    | 1625                  | 1705   | 1785   | 1865                             | 1945                      | 1230   | 1290     | 1350      |
| 186 ARMLESS LOVESEAT BUMPER STORAGE-L  | 68x40x33/40     | 2420    | 2500                  | 2580   | 2660   | 2740                             | 2820                      | 1950   | 2015     | 2080      |
| 187 ARMLESS LOVESEAT BUMPER STORAGE-R  | 68x40x33/40     | 2420    | 2500                  | 2580   | 2660   | 2740                             | 2820                      | 1950   | 2015     | 2080      |
| 188 ARMLESS CHAIR BUMPER STORAGE-L     | 45x40x33/40     | 1600    | 1690                  | 1780   | 1870   | 1960                             | 2050                      | 1295   | 1330     | 1365      |
| 189 ARMLESS CHAIR BUMPER STORAGE-R     | 45x40x33/40     | 1600    | 1690                  | 1780   | 1870   | 1960                             | 2050                      | 1295   | 1330     | 1365      |
| 190 SMALL WEDGE STORAGE                | 11/21x36x24     | 720     | 745                   | 770  | 795  | 820                              | 845                       | 550    | 570      | 590       |
| 221 ARMLESS DBL CHAIR BUMPER STORAGE-L | 52x40x33/40     | 1705    | 1790                  | 1875   | 1960   | 2045                             | 2130                      | 1390   | 1450     | 1510      |
| 222 ARMLESS DBL CHAIR BUMPER STORAGE-R | 52x40x33/40     | 1705    | 1790                  | 1875   | 1960   | 2045                             | 2130                      | 1390   | 1450     | 1510      |
| 223 APT SOFA NO ARM BUMPER STORAGE-L   | 82x40x33/40     | 2655    | 2785                  | 2915   | 3045   | 3175                             | 3305                      | 2120   | 2215     | 2310      |
| 224 APT SOFA NO ARM BUMPER STORAGE-R   | 82x40x33/40     | 2655    | 2785                  | 2915   | 3045   | 3175                             | 3305                      | 2120   | 2215     | 2310      |
| 236 RECLINING LOUNGE CHAIR LEFT ARM    | 35x62x33/40     | 2160    | 2225                  | 2290   | 2355   | 2420                             | 2485                      | 1820   | 1880     | 1940      |
| 237 RECLINING LOUNGE CHAIR RIGHT ARM   | 35x62x33/40     | 2160    | 2225                  | 2290   | 2355   | 2420                             | 2485                      | 1820   | 1880     | 1940      |
| 238 RECLINING DBL LOUNGE CHAIR L-ARM   | 42x62x33/40     | 2315    | 2405                  | 2495   | 2585   | 2675                             | 2765                      | 1940   | 2020     | 2100      |
| 239 RECLINING DBL LOUNGE CHAIR R-ARM   | 42x62x33/40     | 2315    | 2405                  | 2495   | 2585   | 2675                             | 2765                      | 1940   | 2020     | 2100      |
| V51 WINE GLASS HOLDER                  | 3.5 x 5.5 x 6.5 | 35      | 35                    | 35   | 35   | 35                               | 35                        | 35     | 35       | 35        |
| V52 PLASTIC SWIVEL TRAY                | 13 3/8 x 9 5/8  | 35      | 35                    | 35   | 35   | 35                               | 35                        | 35     | 35       | 35        |

## BERLIN

### FEATURES:

- Manual adjustable headrest on all items (2 on square corner & stationary on wedge).
- \*Wall hugger power recliners with full footrest (manual n/a).
- Power recliner lounge chair (manual n/a) with power headrest in option. Wall clearance 8" & front 5".
- Seat cushions with shaped foam + 1" layer of memory foam on top.
- Stitching: Small thread in fabric & large flat thread in leather.
- \*Excludes 043 & 163 chairs: Wall clearance 16"

Note: 2 recliner seats separated by a corner can not be opened at the same time. No recliner seats beside #155 Small Square Corner.

### OPTIONS

- Battery Pack: Add \$160/ea.
- \*Motorized headrest:: Add \$160 ea. (\*N/A on stationary items).
- Foam: Extra ferme ajoutez \$15/siège.
- Choice of Large or Small 6" Arm: Legs on LARGE arm: LG187 wood or LG189 metal (Black or Chrome). SMALL Arm: LG195 wood or LG196 metal (Black or Chrome). Specify colour.
- Seat Depth: 20" or \*22". \*22" seat depth N/A on chairs 043 & 163.
- 043 & 163 Chairs: with wood base (specify colour).

### HOME THEATRE Configurations

For Accessories, Cup holders & Configuration details, see Optima Home Theatre page attached.

Accessory Dock : \$35 ea.

Cup Holders: Metal: \$25 ea. | LED lighted Cup Holder: \$25 ea. | \*LED lighted Cup Holder with (1 or 2 motor) controls: \$40 ea.

\*LED Light strip under seat: \$25/seat.

| Description                 | L x D x H          | Leather |                       |  |  |                                  |                           | Fabric |          |           |    |
|-----------------------------|--------------------|---------|-----------------------|--|--|----------------------------------|---------------------------|--------|----------|-----------|----|
|                             |                    | 10      | 20<br>Madras<br>Softy | 30<br>Hugo<br>Fantasy<br>Illusion<br>Tucson<br>Utah<br>Vintage<br>Wild Laredo<br>Yukon | 40<br>Elegance<br>Princess<br>Santiago<br>Sensation<br>Sunset<br>Trina<br>Victoria | 50<br>Bull<br>Cassiope<br>Dublin | 60<br>Caress<br>Ultrasued | A      | B<br>COM | C<br>alta |    |
| V53 WOOD SWIVEL TRAY        | 19 x 10            | 60      | 60                    | 60   | 60   | 60                               | 60                        | 60     | 60       | 60        | 60 |
| V54 TABLET HOLDER           | 4.5 x 8 x 10       | 40      | 40                    | 40   | 40   | 40                               | 40                        | 40     | 40       | 40        | 40 |
| V55 LED LAMP                | 1.5x5x14 plié/bent | 35      | 35                    | 35   | 35   | 35                               | 35                        | 35     | 35       | 35        | 35 |
| <b>CONFIGURATIONS</b>       |                    |         |                       |  |  |                                  |                           |        |          |           |    |
| _A CONFIG (169-170)         | 84X40X40           | 3980    | 4140                  | 4300   | 4460   | 4620                             | 4780                      | 3340   | 3500     | 3660      |    |
| _B CONFIG (169-171-174)     | 115X62X40          | 5480    | 5700                  | 5920   | 6140   | 6360                             | 6580                      | 4525   | 4745     | 4965      |    |
| _C CONFIG (096-055-171-170) | 116X116X40         | 8050    | 8385                  | 8720   | 9055   | 9390                             | 9725                      | 6520   | 6805     | 7090      |    |
| _D CONFIG (169-171-055-179) | 116X96X40          | 7025    | 7330                  | 7635   | 7940   | 8245                             | 8550                      | 5730   | 5985     | 6240      |    |
| _J CONFIG (041-042)         | 70X40X40           | 3770    | 3920                  | 4070   | 4220   | 4370                             | 4520                      | 3210   | 3280     | 3350      |    |
| _K CONFIG (041-071-005)     | 94X62X40           | 5120    | 5315                  | 5510   | 5705   | 5900                             | 6095                      | 4265   | 4420     | 4575      |    |
| _L CONFIG (012-055-071-042) | 102X102X40         | 7590    | 7915                  | 8240   | 8565   | 8890                             | 9215                      | 6215   | 6440     | 6665      |    |
| _M CONFIG (041-071-055-089) | 103X89X40          | 6710    | 7030                  | 7350   | 7670   | 7990                             | 8310                      | 5495   | 5680     | 5865      |    |





# BERLIN

**OPTIMA**  
Collection

**Jaymar**

Conçu et fabriqué fièrement au Canada  
Proudly designed and made in Canada

Nos produits sont fabriqués à la main et des variations mineures peuvent survenir.

Our product is hand-made and minor variations can occur.

## SPECIFICATIONS

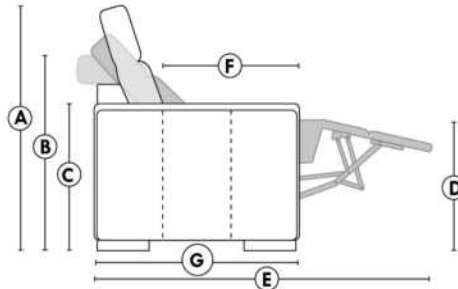

- Appui-tête levé / Headrest up
- Appui-tête baissé / Headrest down
- Complètement incliné / Fully reclined

- A** Hauteur complète 40" / Total Height
- B** Hauteur appui-tête baissé 33" / Height headrest down
- C** Hauteur du bras 24" / Arm Height
- D** Hauteur du siège 19,5" / Seat height
- E** Profondeur inclinée 65" / Depth fully reclined
- F** Profondeur d'assise 20" ou/ou 22" / Seat depth
- G** Profondeur appui-tête monté 37,5" / Depth with headrest up

## BRAS | ARMS

Option de bras:  
Bras Régulier Large 10,5" ou Petit bras 6"

Arm option  
Regular arm Large 10,5" or Small arm 6"

Contrôle de l'inclinaison situé à l'intérieur du bras  
Recliner control located on the inside of the arm.

Option d'accessoires disponible sur le bras régulier seulement  
Accessories option, available on Regular arms ONLY.

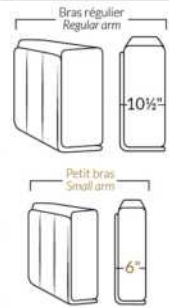

## FAUTEUIL BERÇANT PIVOTANT INCLINABLE SWIVEL ROCKING MOTION CHAIR



## SIÈGE 23" DE LARGE | 23" SEAT WIDTH

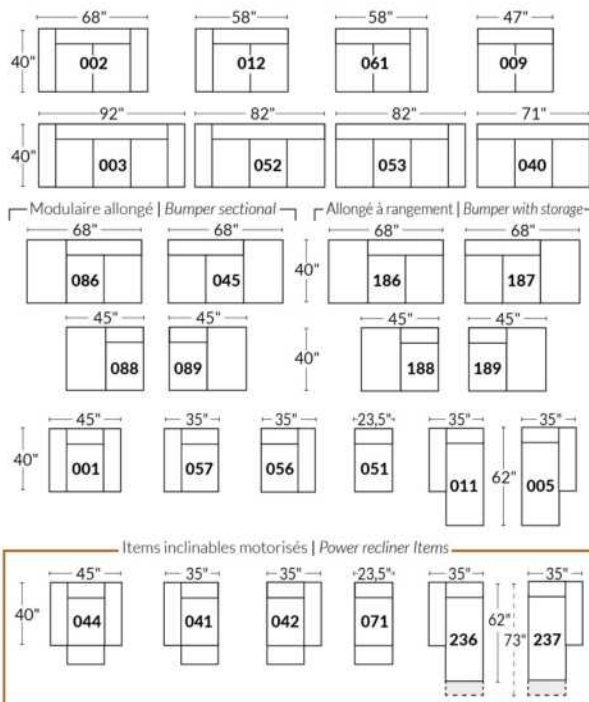

## SIÈGE 30" DE LARGE | 30" SEAT WIDTH

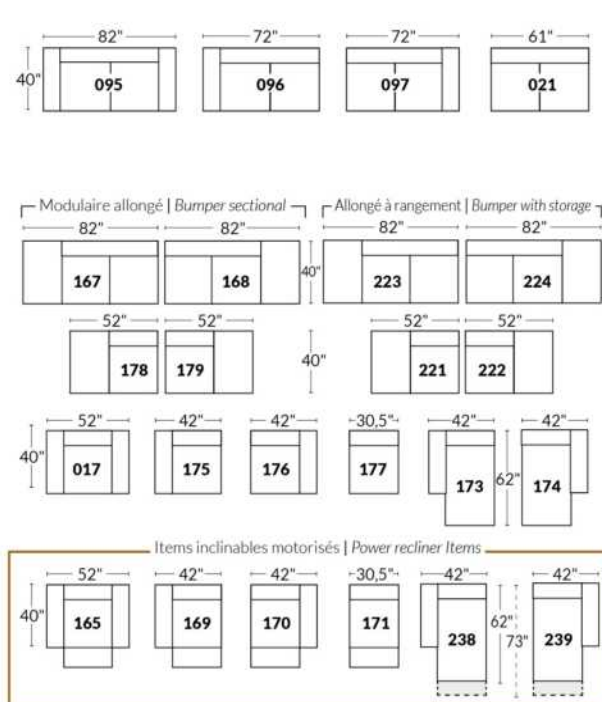

### Autres | Others

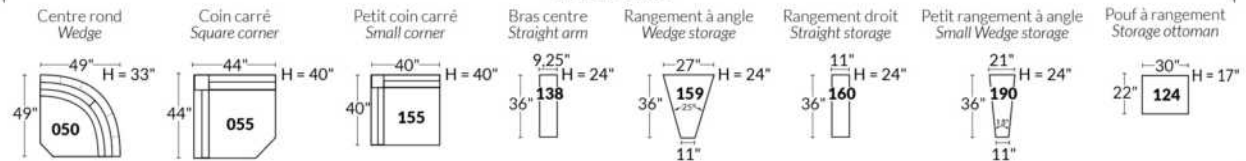

### EXEMPLE 23" EXAMPLE

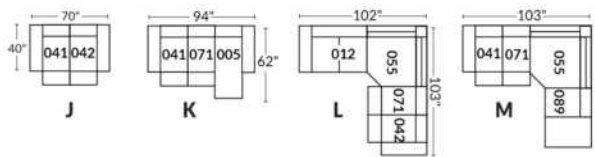

### EXEMPLE 30" EXAMPLE

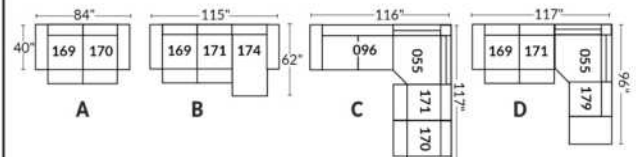

\*Available on certain models and on large arms ONLY.

### OPTIONS CUP HOLDERS

#### METAL



Silver



Matte Black



Brown

#### ILLUMINATED

1.



LED Lighted Cup holder

2.



LED Lighted Cup holder with Single Motor Control, USB Port and LED Baserail

3.



LED Lighted Cup holder with Dual Motor Control, USB Port and LED Baserail

Our illuminated one or two-control cup holders are compatible with LED lights under the seat. You can control the light on the cup holder. The 2 motor cup holder has a reset (home) button control to close your recliner back to its starting position.

#### LED Light under seat (Optional)

Available only in configurations with a minimum of 1 illuminated motorized cup holder with control buttons. The "light" button will control the opening and closing of the light.

For cup holder prices see description section of the Optima model price list.

Please provide us with a drawing of your configuration which indicates the cup holder type and its positioning.

#### Cup holder with controller:

It is important to specify the placement of the cups; on left arm or right arm and which recliner they will control. If you have a row of several seats with cup holders, by default, the controls will be on the left arms and on the right arm for the last outer chair.

#### EXAMPLE A:

041-169: Controller and cup holder on the left arm

071-171: hidden touch sensor buttons on side of seat

042-170: Controller and cup holder on right arm



#### EXAMPLE B:

071-171: These two items can be connected to a smart cup holder which will control the recliner. You must then use one of these items: 138,159, 160 and 190



#### Informations about headrest, controller on reclining seat

#### WITH illuminated cup holder

If you have a **stationary item**, you will have cup holder N°1.

If you have a recliner chair with a **manual headrest**, you will have the cup holder N°2.

If you have a recliner chair with an **electric headrest**, you will have cup holder N°3.

#### Without cup holder and with a reclining seat

If you have a recliner with a **manual headrest** you will have the touch sensor button control on the side of the seat.

If you have a recliner with an **electric headrest** you will have a dual push button controller with USB port on the arm.

If you have an **armless recliner**, you will have the hidden touch sensor button control.



Hidden touch sensor



Dual push button

# OPTIMA

## HOME THEATRE Configurations

\*Available on certain models and on large arms ONLY.

OPTIONS

### ACCESSORIES

Accessory Dock



V51 Wine Glass Holder



V52 Plastic Swivel Tray Table



V53 Wood Swivel tray Table  
(Choice of 8 colors)



Specify on which arm (left or right) the tray table will be installed.

V54 Tablet Holder



V55 LED Lamp



(For Accessory Dock price, see description section of the Optima model price list and for Accessory item prices, see at very end of the price list)

### Items 138-159-160-190 and large arm.

Accessory docks and cups are Optional. \*Not available on small arms\*

Please specify on which arms you want the accessory docks and cup holders.

NB: Item 138-159-160-190 are unfinished on the sides, must be used between 2 seats.

Each storage item has 2 USB ports and one electrical outlet inside the storage.



### SUGGESTED CONFIGURATIONS

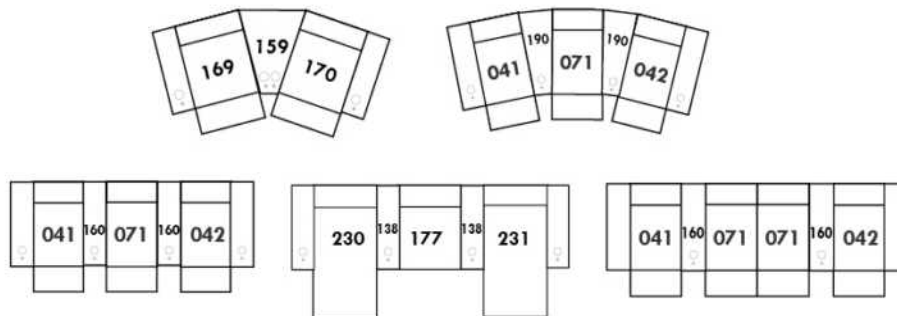

## CDN Price List

### BRASILIA

LG52 available metal or wood. If wood specify colour.

COMBO: Cover #2 on back only.

FABRIC: There is no stitching on seat cushion.

Plain fabric recommended for the base.

\*REMARK: In leather and fabric, armless end pieces and wedge are not fully upholstered.

| Description                             | L x D x H | Leather |                       |  |  |                                  |                           | Fabric |          |           |
|---|-----------|---------|-----------------------|--|--|----------------------------------|---------------------------|--------|----------|-----------|
|   |           | 10      | 20<br>Madras<br>Softy | 30<br>Hugo<br>Fantasy<br>Illusion<br>Tucson<br>Utah<br>Vintage<br>Wild Laredo<br>Yukon | 40<br>Elegance<br>Princess<br>Santiago<br>Sensation<br>Sunset<br>Trina<br>Victoria | 50<br>Bull<br>Cassiope<br>Dublin | 60<br>Caress<br>Ultrasued | A      | B<br>COM | C<br>alta |
| 001 CHAIR                               | 35X37X33  | 1275    | 1340                  | 1405   | 1470   | 1535                             | 1600                      | 945    | 995      | 1045      |
| 002 LOVESEAT                            | 59X37X33  | 1855    | 1970                  | 2085   | 2200   | 2315                             | 2430                      | 1230   | 1310     | 1390      |
| 005 LOUNGE CHAIR RIGHT ARM              | 30X65X33  | 1215    | 1325                  | 1435   | 1545   | 1655                             | 1765                      | 890    | 950      | 1010      |
| 009 ARMLESS LOVESEAT                    | 48X37X33  | 1455    | 1565                  | 1675   | 1785   | 1895                             | 2005                      | 1045   | 1120     | 1195      |
| 011 LOUNGE CHAIR LEFT ARM               | 30X65X33  | 1215    | 1325                  | 1435   | 1545   | 1655                             | 1765                      | 890    | 950      | 1010      |
| 012 LOVESEAT LEFT ARM                   | 54X37X33  | 1630    | 1745                  | 1860   | 1975   | 2090                             | 2205                      | 1140   | 1205     | 1270      |
| 021 APARTMENT SOFA NO ARM               | 64X37X33  | 1650    | 1790                  | 1930   | 2070   | 2210                             | 2350                      | 1155   | 1245     | 1335      |
| 045 ARMLESS LOVESEAT BUMPER RIGHT       | 67X37X33  | 1630    | 1745                  | 1860   | 1975   | 2090                             | 2205                      | 1140   | 1205     | 1270      |
| 050 WEDGE                               | 48X48X33  | 1215    | 1305                  | 1395   | 1485   | 1575                             | 1665                      | 925    | 995      | 1065      |
| 051 ARMLESS CHAIR                       | 24X37X33  | 885     | 955                   | 1025   | 1095   | 1165                             | 1235                      | 745    | 790      | 835       |
| 056 CHAIR RIGHT ARM                     | 30X37X33  | 1075    | 1140                  | 1205   | 1270   | 1335                             | 1400                      | 845    | 895      | 945       |
| 057 CHAIR LEFT ARM                      | 30X37X33  | 1075    | 1140                  | 1205   | 1270   | 1335                             | 1400                      | 845    | 895      | 945       |
| 061 LOVESEAT RIGHT ARM                  | 54X37X33  | 1630    | 1745                  | 1860   | 1975   | 2090                             | 2205                      | 1140   | 1205     | 1270      |
| 062 ANGLE CHAIR LEFT ARM                | 64X50X33  | 1585    | 1680                  | 1775   | 1870   | 1965                             | 2060                      | 1130   | 1175     | 1220      |
| 063 ANGLE CHAIR RIGHT ARM               | 64X50X33  | 1585    | 1680                  | 1775   | 1870   | 1965                             | 2060                      | 1130   | 1175     | 1220      |
| 086 ARMLESS LOVESEAT BUMPER LEFT        | 67X37X33  | 1630    | 1745                  | 1860   | 1975   | 2090                             | 2205                      | 1140   | 1205     | 1270      |
| 095 APARTMENT SOFA                      | 75X37X33  | 2065    | 2200                  | 2335   | 2470   | 2605                             | 2740                      | 1360   | 1440     | 1520      |
| 096 APARTMENT SOFA LEFT ARM             | 70X37X33  | 1835    | 1975                  | 2115   | 2255   | 2395                             | 2535                      | 1255   | 1340     | 1425      |
| 097 APARTMENT SOFA RIGHT ARM            | 70X37X33  | 1835    | 1975                  | 2115   | 2255   | 2395                             | 2535                      | 1255   | 1340     | 1425      |
| 105 APARTMENT SOFA RIGHT ARM / BUMPER-L | 89X37X33  | 2065    | 2200                  | 2335   | 2470   | 2605                             | 2740                      | 1360   | 1440     | 1520      |
| 106 APARTMENT SOFA LEFT ARM / BUMPER-R  | 89X37X33  | 2065    | 2200                  | 2335   | 2470   | 2605                             | 2740                      | 1360   | 1440     | 1520      |
| 107 LOVESEAT RIGHT ARM BUMPER LEFT      | 73X37X33  | 1855    | 1970                  | 2085   | 2200   | 2315                             | 2430                      | 1230   | 1310     | 1390      |
| 108 LOVESEAT LEFT ARM BUMPER RIGHT      | 73X37X33  | 1855    | 1970                  | 2085   | 2200   | 2315                             | 2430                      | 1230   | 1310     | 1390      |
| 124 STORAGE OTTOMAN                     | 30X22X18  | 755     | 780                   | 805  | 830  | 855                              | 880                       | 645    | 670      | 695       |
| <b>CONFIGURATIONS</b>                   |           |         |                       |  |  |                                  |                           |        |          |           |
| A CONF. A (95-01)                       | 35X75X33  | 3340    | 3540                  | 3740   | 3940   | 4140                             | 4340                      | 2305   | 2435     | 2565      |
| B CONF. B (96-05)                       | 100X65X33 | 3050    | 3300                  | 3550   | 3800   | 4050                             | 4300                      | 2145   | 2290     | 2435      |

## CDN Price List

### BRASILIA

| Description          | L x D x H  | Leather |                       |  |  |                                  |                           | Fabric |          |           |
|----------------------|------------|---------|-----------------------|--|--|----------------------------------|---------------------------|--------|----------|-----------|
|                      |            | 10      | 20<br>Madras<br>Softy | 30<br>Hugo<br>Fantasy<br>Illusion<br>Tucson<br>Utah<br>Vintage<br>Wild Laredo<br>Yukon | 40<br>Elegance<br>Princess<br>Santiago<br>Sensation<br>Sunset<br>Trina<br>Victoria | 50<br>Bull<br>Cassiope<br>Dublin | 60<br>Caress<br>Ultrasued | A      | B<br>COM | C<br>alta |
| C CONF. C (11-97)    | 65X100X33  | 3050    | 3300                  | 3550   | 3800   | 4050                             | 4300                      | 2145   | 2290     | 2435      |
| D CONF. D (96-63)    | 134X50X33  | 3420    | 3655                  | 3890   | 4125   | 4360                             | 4595                      | 2385   | 2515     | 2645      |
| E CONF. E (62-97)    | 50X134X33  | 3420    | 3655                  | 3890   | 4125   | 4360                             | 4595                      | 2385   | 2515     | 2645      |
| F CONF. F (12-05)    | 84X65X33   | 2845    | 3070                  | 3295   | 3520   | 3745                             | 3970                      | 2030   | 2155     | 2280      |
| G CONF. G (11-61)    | 65X84X33   | 2845    | 3070                  | 3295   | 3520   | 3745                             | 3970                      | 2030   | 2155     | 2280      |
| H CONF. H (86-05)    | 97X65X33   | 2845    | 3070                  | 3295   | 3520   | 3745                             | 3970                      | 2030   | 2155     | 2280      |
| I CONF. I (11-45)    | 65X97X33   | 2845    | 3070                  | 3295   | 3520   | 3745                             | 3970                      | 2030   | 2155     | 2280      |
| J CONF. J (12-63)    | 118X50X33  | 3215    | 3425                  | 3635   | 3845   | 4055                             | 4265                      | 2270   | 2380     | 2490      |
| K CONF. K (62-61)    | 50X118X33  | 3215    | 3425                  | 3635   | 3845   | 4055                             | 4265                      | 2270   | 2380     | 2490      |
| L CONF. L (86-63)    | 131X50X33  | 3215    | 3425                  | 3635   | 3845   | 4055                             | 4265                      | 2270   | 2380     | 2490      |
| M CONF. M (62-45)    | 50X131X33  | 3215    | 3425                  | 3635   | 3845   | 4055                             | 4265                      | 2270   | 2380     | 2490      |
| N CONF. N (95-02)    | 59X75X33   | 3920    | 4170                  | 4420   | 4670   | 4920                             | 5170                      | 2590   | 2750     | 2910      |
| O CONF. O (12-50-61) | 102X102X33 | 4475    | 4795                  | 5115   | 5435   | 5755                             | 6075                      | 3205   | 3405     | 3605      |
| P CONF. P (107-106)  | 73X89X33   | 3920    | 4170                  | 4420   | 4670   | 4920                             | 5170                      | 2590   | 2750     | 2910      |
| Q CONF. Q (105-108)  | 89X73X33   | 3920    | 4170                  | 4420   | 4670   | 4920                             | 5170                      | 2590   | 2750     | 2910      |
| R CONF. R (107-108)  | 73X73X33   | 3710    | 3940                  | 4170   | 4400   | 4630                             | 4860                      | 2460   | 2620     | 2780      |
| S CONF. S (86-50-61) | 115X102X33 | 4475    | 4795                  | 5115   | 5435   | 5755                             | 6075                      | 3205   | 3405     | 3605      |
| T CONF. T (12-50-45) | 102X115X33 | 4475    | 4795                  | 5115   | 5435   | 5755                             | 6075                      | 3205   | 3405     | 3605      |
| U CONF. U (86-50-45) | 115X115X33 | 4475    | 4795                  | 5115   | 5435   | 5755                             | 6075                      | 3205   | 3405     | 3605      |
| V CONF. V (96-50-61) | 118X102X33 | 4680    | 5025                  | 5370   | 5715   | 6060                             | 6405                      | 3320   | 3540     | 3760      |
| W CONF. W (12-50-97) | 102X118X33 | 4680    | 5025                  | 5370   | 5715   | 6060                             | 6405                      | 3320   | 3540     | 3760      |
| X CONF. X (96-50-45) | 118X115X33 | 4680    | 5025                  | 5370   | 5715   | 6060                             | 6405                      | 3320   | 3540     | 3760      |
| Y CONF. Y (86-50-97) | 115X118X33 | 4680    | 5025                  | 5370   | 5715   | 6060                             | 6405                      | 3320   | 3540     | 3760      |

# BRASILIA



Hauteur complète 33" | Hauteur de siège 19" | Hauteur devant bras 25" | Profondeur d'assise 21"  
 Total Height 33" | Seat Height 19" | Arm Height 25" | Seat Depth 21"

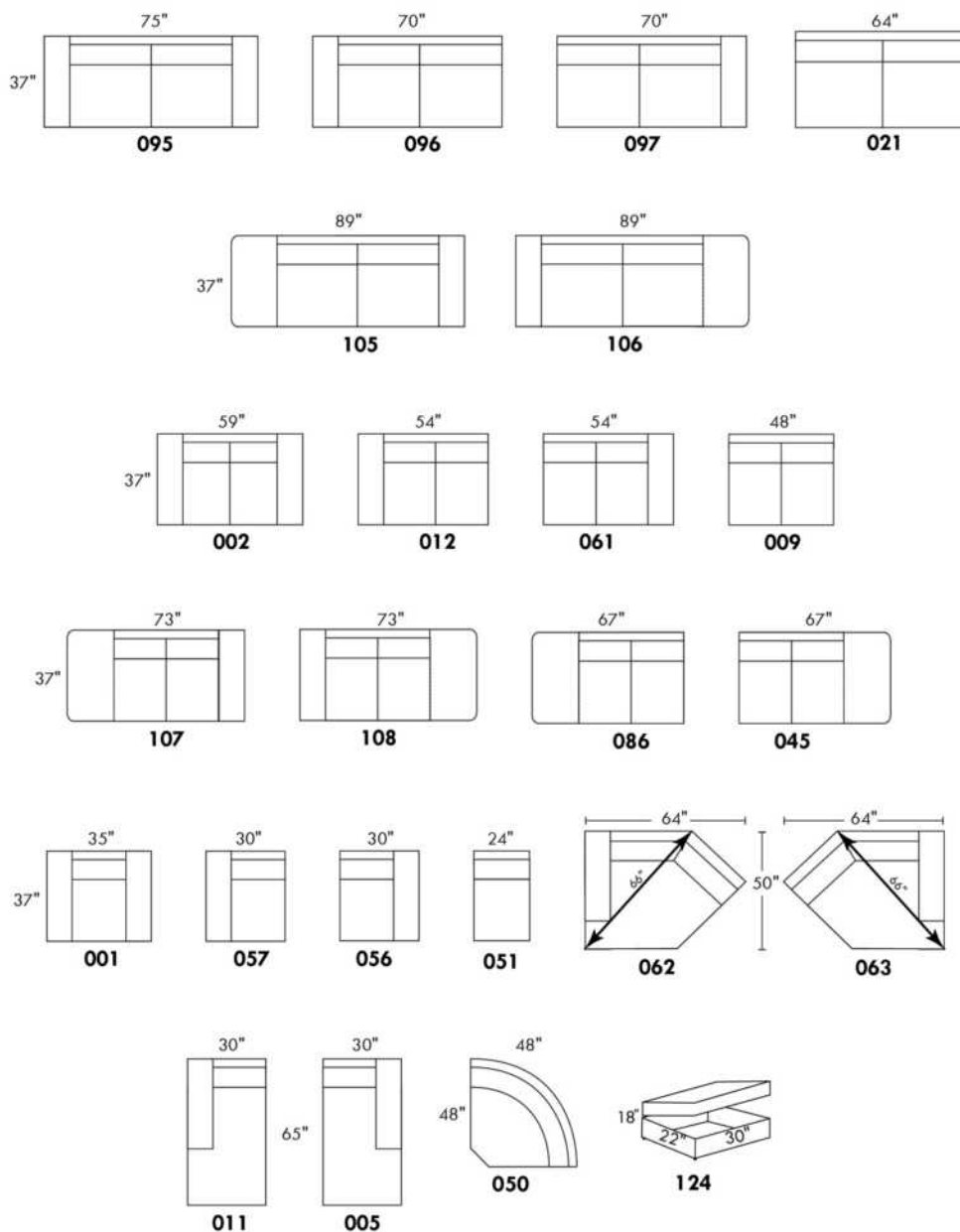

www.jaymar.ca

Toutes les dimensions indiquées sont au pouce près. Nos produits sont fabriqués à la main et des variations mineures peuvent survenir.  
 All dimensions indicated are to the nearest inch. Our product is hand-made and minor variations can occur.



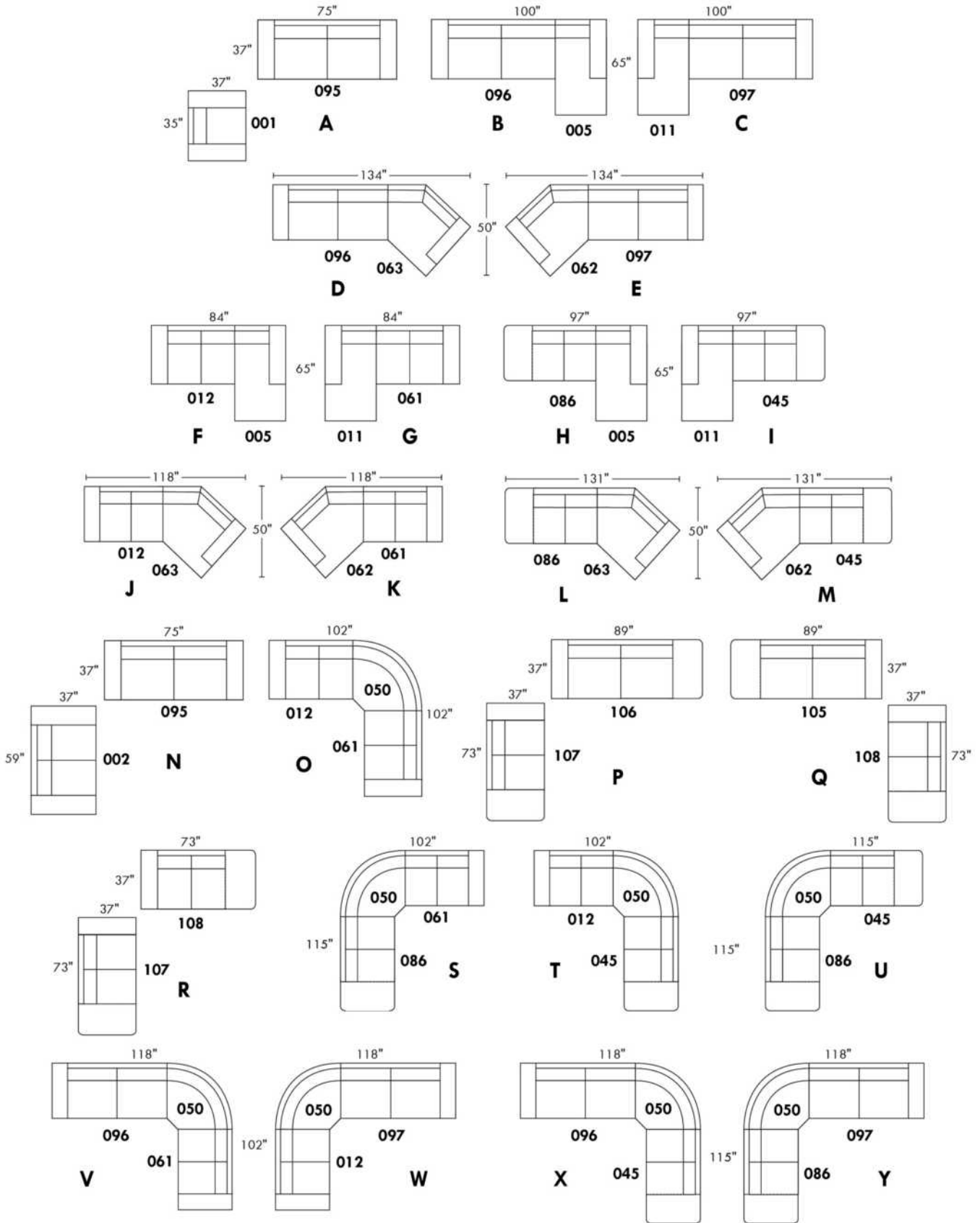

## BROOKLYN

**FEATURES:**

- Manual adjustable headrest on all items (2 on square corner & stationary on wedge).
- \*Wall hugger power recliners with full footrest (manual n/a).
- Power recliner lounge chair (manual n/a) with power headrest in option. Wall clearance 8" & front 5".
- Seat cushions with shaped foam + 1" layer of memory foam on top; arm with memory foam.
- Stitching: Small thread in fabric & large flat thread in leather.
- \*Excludes 043 & 163 chairs: Wall clearance 16"

Note: 2 recliner seats separated by a corner can not be opened at the same time. No recliner seats beside #155 Small Square Corner.

**OPTIONS**

- Battery Pack: Add \$160/ea.
- \*Motorized headrest: Add \$160 ea. (\*N/A on stationary items).
- Foam: Extra firm add \$15/seat.
- Choice of Large or Small 6" Arm: Leg on LARGE arm: LG187 wood or LG189 metal (Black or Chrome). Leg on SMALL Arm: LG08 wood or LG64 metal. Specify colour.
- Seat Depth: 20" or \*22". \*22" seat depth N/A on chairs 043 & 163.
- 043 & 163 Chairs: with wood base (specify colour).

| Description                        | L x D x H     | Leather |                       |  |  |                                  |                           | Fabric |          |           |
|------------------------------------|---------------|---------|-----------------------|--|--|----------------------------------|---------------------------|--------|----------|-----------|
|                                    |               | 10      | 20<br>Madras<br>Softy | 30<br>Hugo<br>Fantasy<br>Illusion<br>Tucson<br>Utah<br>Vintage<br>Wild Laredo<br>Yukon | 40<br>Elegance<br>Princess<br>Santiago<br>Sensation<br>Trina<br>Victoria | 50<br>Bull<br>Cassiope<br>Dublin | 60<br>Caress<br>Ultrasued | A      | B<br>COM | C<br>alta |
| 001 CHAIR                          | 43x40x33/40   | 1890    | 1980                  | 2070   | 2160   | 2250                             | 2340                      | 1535   | 1580     | 1625      |
| 002 LOVESEAT                       | 66x40x33/40   | 2700    | 2815                  | 2930   | 3045   | 3160                             | 3275                      | 2175   | 2250     | 2325      |
| 003 SOFA                           | 90x40x33/40   | 3265    | 3415                  | 3565   | 3715   | 3865                             | 4015                      | 2625   | 2715     | 2805      |
| 005 LOUNGE CHAIR RIGHT ARM         | 34x62x33/40   | 1765    | 1830                  | 1895   | 1960   | 2025                             | 2090                      | 1410   | 1470     | 1530      |
| 009 ARMLESS LOVESEAT               | 47x40x33/40   | 1895    | 1965                  | 2035   | 2105   | 2175                             | 2245                      | 1490   | 1570     | 1650      |
| 011 LOUNGE CHAIR LEFT ARM          | 34x62x33/40   | 1765    | 1830                  | 1895   | 1960   | 2025                             | 2090                      | 1410   | 1470     | 1530      |
| 012 LOVESEAT LEFT ARM              | 57x40x33/40   | 2320    | 2420                  | 2520   | 2620   | 2720                             | 2820                      | 1850   | 1925     | 2000      |
| 017 DOUBLE CHAIR                   | 50x40x33/40   | 1980    | 2080                  | 2180   | 2280   | 2380                             | 2480                      | 1600   | 1660     | 1720      |
| 021 APARTMENT SOFA NO ARM          | 61x40x33/40   | 2140    | 2240                  | 2340   | 2440   | 2540                             | 2640                      | 1670   | 1755     | 1840      |
| 040 ARMLESS SOFA                   | 71x40x33/40   | 2450    | 2565                  | 2680   | 2795   | 2910                             | 3025                      | 1950   | 2040     | 2130      |
| 041 RECLINING CHAIR LEFT ARM       | 34x40x33/40   | 1885    | 1960                  | 2035   | 2110   | 2185                             | 2260                      | 1605   | 1640     | 1675      |
| 042 RECLINING CHAIR RIGHT ARM      | 34x40x33/40   | 1885    | 1960                  | 2035   | 2110   | 2185                             | 2260                      | 1605   | 1640     | 1675      |
| 043 SWIVEL ROCKING RECLINING CHAIR | 30x34x42      | 2235    | 2345                  | 2455   | 2565   | 2675                             | 2785                      | 1875   | 1920     | 1965      |
| 044 RECLINER CHAIR                 | 43x40x33/40   | 2275    | 2365                  | 2455   | 2545   | 2635                             | 2725                      | 1920   | 1970     | 2020      |
| 045 ARMLESS LOVESEAT BUMPER RIGHT  | 68x40x33/40   | 2245    | 2340                  | 2435   | 2530   | 2625                             | 2720                      | 1785   | 1850     | 1915      |
| 050 WEDGE                          | 49x49x33      | 1645    | 1745                  | 1845   | 1945   | 2045                             | 2145                      | 1210   | 1270     | 1330      |
| 051 ARMLESS CHAIR                  | 23,5x40x33/40 | 1085    | 1135                  | 1185   | 1235   | 1285                             | 1335                      | 845    | 900      | 955       |
| 052 SOFA LEFT ARM                  | 81x40x33/40   | 2870    | 3005                  | 3140   | 3275   | 3410                             | 3545                      | 2290   | 2385     | 2480      |



## BROOKLYN

### FEATURES:

- Manual adjustable headrest on all items (2 on square corner & stationary on wedge).
- \*Wall hugger power recliners with full footrest (manual n/a).
- Power recliner lounge chair (manual n/a) with power headrest in option. Wall clearance 8" & front 5".
- Seat cushions with shaped foam + 1" layer of memory foam on top; arm with memory foam.
- Stitching: Small thread in fabric & large flat thread in leather.
- \*Excludes 043 & 163 chairs: Wall clearance 16"

Note: 2 recliner seats separated by a corner can not be opened at the same time. No recliner seats beside #155 Small Square Corner.

### OPTIONS

- Battery Pack: Add \$160/ea.
- \*Motorized headrest: Add \$160 ea. (\*N/A on stationary items).
- Foam: Extra firm add \$15/seat.
- Choice of Large or Small 6" Arm: Leg on LARGE arm: LG187 wood or LG189 metal (Black or Chrome). Leg on SMALL Arm: LG08 wood or LG64 metal. Specify colour.
- Seat Depth: 20" or \*22". \*22" seat depth N/A on chairs 043 & 163.
- 043 & 163 Chairs: with wood base (specify colour).

| Description                            | L x D x H     | Leather |                       |  |  |                                  |                           | Fabric |          |           |
|--|---------------|---------|-----------------------|--|--|----------------------------------|---------------------------|--------|----------|-----------|
|  |               | 10      | 20<br>Madras<br>Softy | 30<br>Hugo<br>Fantasy<br>Illusion<br>Tucson<br>Utah<br>Vintage<br>Wild Laredo<br>Yukon | 40<br>Elegance<br>Princess<br>Santiago<br>Sensation<br>Sunset<br>Trina<br>Victoria | 50<br>Bull<br>Cassiope<br>Dublin | 60<br>Caress<br>Ultrasued | A      | B<br>COM | C<br>alta |
| 053 SOFA RIGHT ARM                     | 81x40x33/40   | 2870    | 3005                  | 3140   | 3275   | 3410                             | 3545                      | 2290   | 2385     | 2480      |
| 055 SQUARE CORNER                      | 44x44x33/40   | 1915    | 2010                  | 2105   | 2200   | 2295                             | 2390                      | 1510   | 1565     | 1620      |
| 056 CHAIR RIGHT ARM                    | 34x40x33/40   | 1510    | 1575                  | 1640   | 1705   | 1770                             | 1835                      | 1200   | 1260     | 1320      |
| 057 CHAIR LEFT ARM                     | 34x40x33/40   | 1510    | 1575                  | 1640   | 1705   | 1770                             | 1835                      | 1200   | 1260     | 1320      |
| 061 LOVESEAT RIGHT ARM                 | 57x40x33/40   | 2320    | 2420                  | 2520   | 2620   | 2720                             | 2820                      | 1850   | 1925     | 2000      |
| 071 ARMLESS RECLINING CHAIR            | 23,5x40x33/40 | 1470    | 1525                  | 1580   | 1635   | 1690                             | 1745                      | 1250   | 1310     | 1370      |
| 086 ARMLESS LOVESEAT BUMPER LEFT       | 68x40x33/40   | 2245    | 2340                  | 2435   | 2530   | 2625                             | 2720                      | 1785   | 1850     | 1915      |
| 088 ARMLESS CHAIR BUMPER LEFT          | 45x40x33/40   | 1440    | 1535                  | 1630   | 1725   | 1820                             | 1915                      | 1130   | 1165     | 1200      |
| 089 ARMLESS CHAIR BUMPER RIGHT         | 45x40x33/40   | 1440    | 1535                  | 1630   | 1725   | 1820                             | 1915                      | 1130   | 1165     | 1200      |
| 095 APARTMENT SOFA                     | 80x40x33/40   | 2940    | 3085                  | 3230   | 3375   | 3520                             | 3665                      | 2350   | 2445     | 2540      |
| 096 APARTMENT SOFA LEFT ARM            | 71x40x33/40   | 2570    | 2680                  | 2790   | 2900   | 3010                             | 3120                      | 2020   | 2110     | 2200      |
| 097 APARTMENT SOFA RIGHT ARM           | 71x40x33/40   | 2570    | 2680                  | 2790   | 2900   | 3010                             | 3120                      | 2020   | 2110     | 2200      |
| 124 STORAGE OTTOMAN                    | 30x22x17      | 745     | 765                   | 785  | 805  | 825                              | 845                       | 650    | 670      | 690       |
| 155 SMALL SQUARE CORNER                | 40x40x33/40   | 1915    | 2010                  | 2105   | 2200   | 2295                             | 2390                      | 1510   | 1565     | 1620      |
| 163 DBL SWIVEL ROCKING RECLINER CHAIR  | 33x34x42      | 2290    | 2410                  | 2530   | 2650   | 2770                             | 2890                      | 1880   | 1930     | 1980      |
| 165 DOUBLE RECLINING CHAIR             | 50x40x33/40   | 2375    | 2475                  | 2575   | 2675   | 2775                             | 2875                      | 2000   | 2065     | 2130      |
| 167 APARTMENT SOFA NO ARM BUMPER LEFT  | 82x40x33/40   | 2490    | 2620                  | 2750   | 2880   | 3010                             | 3140                      | 1960   | 2045     | 2130      |
| 168 APARTMENT SOFA NO ARM BUMPER RIGHT | 82x40x33/40   | 2490    | 2620                  | 2750   | 2880   | 3010                             | 3140                      | 1960   | 2045     | 2130      |
| 169 DOUBLE RECLINING CHAIR LEFT ARM    | 41x40x33/40   | 1990    | 2070                  | 2150   | 2230   | 2310                             | 2390                      | 1670   | 1750     | 1830      |

## BROOKLYN

### FEATURES:

- Manual adjustable headrest on all items (2 on square corner & stationary on wedge).
- \*Wall hugger power recliners with full footrest (manual n/a).
- Power recliner lounge chair (manual n/a) with power headrest in option. Wall clearance 8" & front 5".
- Seat cushions with shaped foam + 1" layer of memory foam on top; arm with memory foam.
- Stitching: Small thread in fabric & large flat thread in leather.
- \*Excludes 043 & 163 chairs: Wall clearance 16"

Note: 2 recliner seats separated by a corner can not be opened at the same time. No recliner seats beside #155 Small Square Corner.

### OPTIONS

- Battery Pack: Add \$160/ea.
- \*Motorized headrest: Add \$160 ea. (\*N/A on stationary items).
- Foam: Extra firm add \$15/seat.
- Choice of Large or Small 6" Arm: Leg on LARGE arm: LG187 wood or LG189 metal (Black or Chrome). Leg on SMALL Arm: LG08 wood or LG64 metal. Specify colour.
- Seat Depth: 20" or \*22". \*22" seat depth N/A on chairs 043 & 163.
- 043 & 163 Chairs: with wood base (specify colour).

| Description                            | L x D x H     | Leather |                       |  |  |                                  |                           | Fabric |          |           |
|--|---------------|---------|-----------------------|--|--|----------------------------------|---------------------------|--------|----------|-----------|
|  |               | 10      | 20<br>Madras<br>Softy | 30<br>Hugo<br>Fantasy<br>Illusion<br>Tucson<br>Utah<br>Vintage<br>Wild Laredo<br>Yukon | 40<br>Elegance<br>Princess<br>Santiago<br>Sensation<br>Trina<br>Victoria | 50<br>Bull<br>Cassiope<br>Dublin | 60<br>Caress<br>Ultrasued | A      | B<br>COM | C<br>alta |
| 170 DOUBLE RECLINING CHAIR RIGHT ARM   | 41x40x33/40   | 1990    | 2070                  | 2150   | 2230   | 2310                             | 2390                      | 1670   | 1750     | 1830      |
| 171 ARMLESS DOUBLE RECLINING CHAIR     | 30,5x40x33/40 | 1575    | 1625                  | 1675   | 1725   | 1775                             | 1825                      | 1320   | 1380     | 1440      |
| 173 DOUBLE LOUNGE CHAIR LEFT ARM       | 41x62x33/40   | 1915    | 2005                  | 2095   | 2185   | 2275                             | 2365                      | 1535   | 1615     | 1695      |
| 174 DOUBLE LOUNGE CHAIR RIGHT ARM      | 41x62x33/40   | 1915    | 2005                  | 2095   | 2185   | 2275                             | 2365                      | 1535   | 1615     | 1695      |
| 175 DOUBLE CHAIR LEFT ARM              | 41x40x33/40   | 1590    | 1680                  | 1770   | 1860   | 1950                             | 2040                      | 1285   | 1350     | 1415      |
| 176 DOUBLE CHAIR RIGHT ARM             | 41x40x33/40   | 1590    | 1680                  | 1770   | 1860   | 1950                             | 2040                      | 1285   | 1350     | 1415      |
| 177 ARMLESS DOUBLE CHAIR               | 30,5x40x33/40 | 1185    | 1250                  | 1315   | 1380   | 1445                             | 1510                      | 915    | 970      | 1025      |
| 178 ARMLESS DOUBLE CHAIR BUMPER LEFT   | 52x40x33/40   | 1545    | 1625                  | 1705   | 1785   | 1865                             | 1945                      | 1230   | 1290     | 1350      |
| 179 ARMLESS DOUBLE CHAIR BUMPER RIGHT  | 52x40x33/40   | 1545    | 1625                  | 1705   | 1785   | 1865                             | 1945                      | 1230   | 1290     | 1350      |
| 186 ARMLESS LOVESEAT BUMPER STORAGE-L  | 68x40x33/40   | 2420    | 2500                  | 2580   | 2660   | 2740                             | 2820                      | 1950   | 2015     | 2080      |
| 187 ARMLESS LOVESEAT BUMPER STORAGE-R  | 68x40x33/40   | 2420    | 2500                  | 2580   | 2660   | 2740                             | 2820                      | 1950   | 2015     | 2080      |
| 188 ARMLESS CHAIR BUMPER STORAGE-L     | 45x40x33/40   | 1600    | 1690                  | 1780   | 1870   | 1960                             | 2050                      | 1295   | 1330     | 1365      |
| 189 ARMLESS CHAIR BUMPER STORAGE-R     | 45x40x33/40   | 1600    | 1690                  | 1780   | 1870   | 1960                             | 2050                      | 1295   | 1330     | 1365      |
| 221 ARMLESS DBL CHAIR BUMPER STORAGE-L | 52x40x33/40   | 1705    | 1790                  | 1875   | 1960   | 2045                             | 2130                      | 1390   | 1450     | 1510      |
| 222 ARMLESS DBL CHAIR BUMPER STORAGE-R | 52x40x33/40   | 1705    | 1790                  | 1875   | 1960   | 2045                             | 2130                      | 1390   | 1450     | 1510      |
| 223 APT SOFA NO ARM BUMPER STORAGE-L   | 82x40x33/40   | 2655    | 2785                  | 2915   | 3045   | 3175                             | 3305                      | 2120   | 2215     | 2310      |
| 224 APT SOFA NO ARM BUMPER STORAGE-R   | 82x40x33/40   | 2655    | 2785                  | 2915   | 3045   | 3175                             | 3305                      | 2120   | 2215     | 2310      |
| 236 RECLINING LOUNGE CHAIR LEFT ARM    | 34x62x33/40   | 2160    | 2225                  | 2290   | 2355   | 2420                             | 2485                      | 1820   | 1880     | 1940      |
| 237 RECLINING LOUNGE CHAIR RIGHT ARM   | 34x62x33/40   | 2160    | 2225                  | 2290   | 2355   | 2420                             | 2485                      | 1820   | 1880     | 1940      |

## BROOKLYN

### FEATURES:

- Manual adjustable headrest on all items (2 on square corner & stationary on wedge).
- \*Wall hugger power recliners with full footrest (manual n/a).
- Power recliner lounge chair (manual n/a) with power headrest in option. Wall clearance 8" & front 5".
- Seat cushions with shaped foam + 1" layer of memory foam on top; arm with memory foam.
- Stitching: Small thread in fabric & large flat thread in leather.
- \*Excludes 043 & 163 chairs: Wall clearance 16"

Note: 2 recliner seats separated by a corner can not be opened at the same time. No recliner seats beside #155 Small Square Corner.

### OPTIONS

- Battery Pack: Add \$160/ea.
- \*Motorized headrest: Add \$160 ea. (\*N/A on stationary items).
- Foam: Extra firm add \$15/seat.
- Choice of Large or Small 6" Arm: Leg on LARGE arm: LG187 wood or LG189 metal (Black or Chrome). Leg on SMALL Arm: LG08 wood or LG64 metal. Specify colour.
- Seat Depth: 20" or \*22". \*22" seat depth N/A on chairs 043 & 163.
- 043 & 163 Chairs: with wood base (specify colour).

| Description                          | L x D x H   | Leather |                       |  |  |                                  |                           | Fabric |          |           |
|--------------------------------------|-------------|---------|-----------------------|--|--|----------------------------------|---------------------------|--------|----------|-----------|
|                                      |             | 10      | 20<br>Madras<br>Softy | 30<br>Hugo<br>Fantasy<br>Illusion<br>Tucson<br>Utah<br>Vintage<br>Wild Laredo<br>Yukon | 40<br>Elegance<br>Princess<br>Santiago<br>Sensation<br>Sunset<br>Trina<br>Victoria | 50<br>Bull<br>Cassiope<br>Dublin | 60<br>Caress<br>Ultrasued | A      | B<br>COM | C<br>alta |
| 238 RECLINING DBL LOUNGE CHAIR L-ARM | 41x62x33/40 | 2315    | 2405                  | 2495   | 2585   | 2675                             | 2765                      | 1940   | 2020     | 2100      |
| 239 RECLINING DBL LOUNGE CHAIR R-ARM | 41x62x33/40 | 2315    | 2405                  | 2495   | 2585   | 2675                             | 2765                      | 1940   | 2020     | 2100      |
| <b>CONFIGURATIONS</b>                |             |         |                       |  |  |                                  |                           |        |          |           |
| A CONFIG (169-170)                   | 81X40X40    | 3980    | 4140                  | 4300   | 4460   | 4620                             | 4780                      | 3340   | 3500     | 3660      |
| B CONFIG (169-171-174)               | 113X62X40   | 5480    | 5700                  | 5920   | 6140   | 6360                             | 6580                      | 4525   | 4745     | 4965      |
| C CONFIG (096-055-171-170)           | 116X116X40  | 8050    | 8385                  | 8720   | 9055   | 9390                             | 9725                      | 6520   | 6805     | 7090      |
| D CONFIG (169-171-055-179)           | 116X96X40   | 7025    | 7330                  | 7635   | 7940   | 8245                             | 8550                      | 5730   | 5985     | 6240      |
| J CONFIG (041-042)                   | 67X40X40    | 3770    | 3920                  | 4070   | 4220   | 4370                             | 4520                      | 3210   | 3280     | 3350      |
| K CONFIG (041-071-005)               | 92X62X40    | 5120    | 5315                  | 5510   | 5705   | 5900                             | 6095                      | 4265   | 4420     | 4575      |
| L CONFIG (012-055-071-042)           | 102X102X40  | 7590    | 7915                  | 8240   | 8565   | 8890                             | 9215                      | 6215   | 6440     | 6665      |
| M CONFIG (041-071-055-089)           | 102X89X40   | 6710    | 7030                  | 7350   | 7670   | 7990                             | 8310                      | 5495   | 5680     | 5865      |



# BROOKLYN

**OPTIMA**  
Collection

**Jaymar**

Conçu et fabriqué fièrement au Canada  
Proudly designed and made in Canada

Nos produits sont fabriqués à la main et des variations mineures peuvent survenir

Our product is hand-made and minor variations can occur.

## SPECIFICATIONS

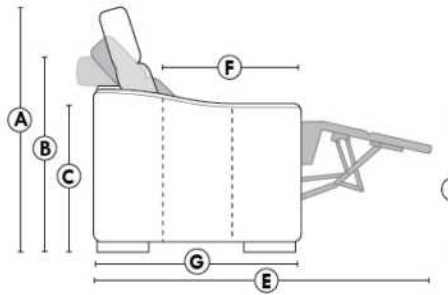

- Appui-tête levé Headrest up
- Appui-tête baissé Headrest down
- Complètement incliné Fully reclined

- A** Hauteur complète 40" Total Height
- B** Hauteur appui-tête baissé 33" Height headrest down
- C** Hauteur du bras 24" Arm Height
- D** Hauteur du siège 19,5" Seat height
- E** Profondeur inclinée 65" Depth fully reclined
- F** Profondeur d'assise 20"ou/ou 22" Seat depth
- G** Profondeur appui-tête monté 37,5" Depth with headrest up

## BRAS | ARMS

Option de bras:  
Bras Régulier Large 9,5" ou Petit bras 6"

Arm option  
Regular arm Large 9.5" or Small arm 6"

Contrôle de l'inclinaison situé à l'extérieur du bras  
Recliner control located on the outside of the arm.

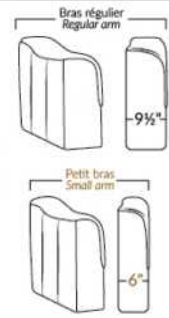

## FAUTEUIL BERÇANT PIVOTANT INCLINABLE SWIVEL ROCKING MOTION CHAIR



## SIÈGE 23" DE LARGE | 23" SEAT WIDTH

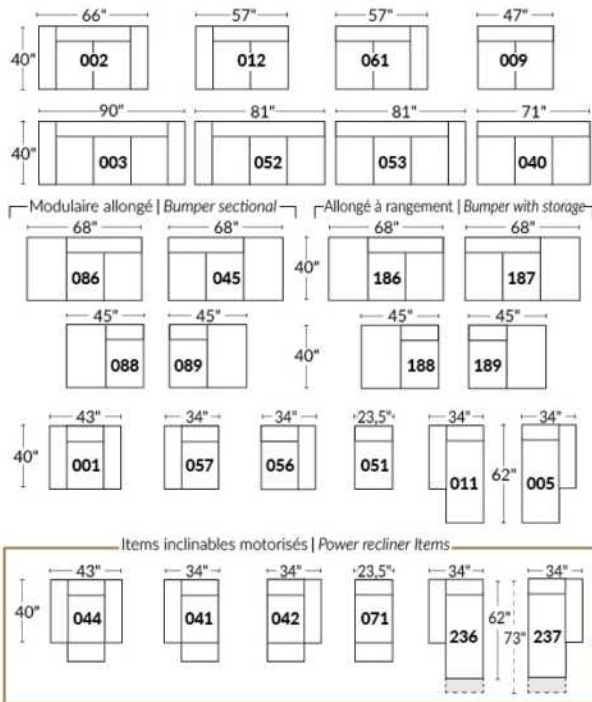

## SIÈGE 30" DE LARGE | 30" SEAT WIDTH

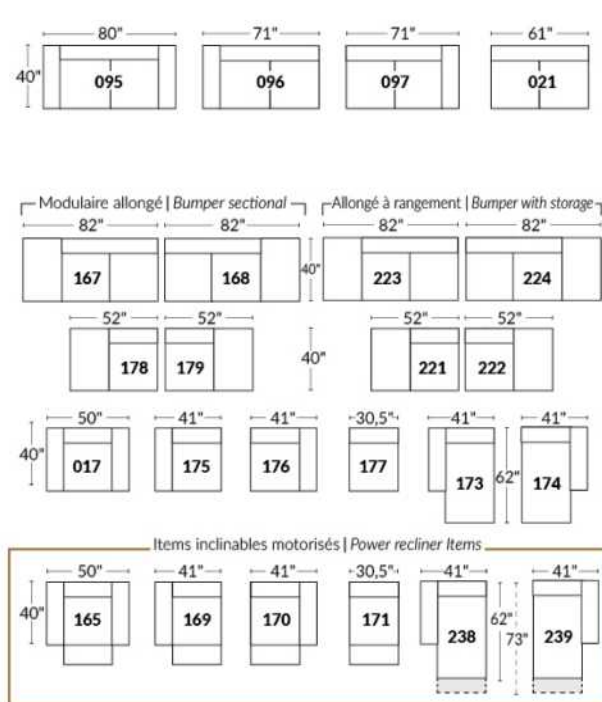

### Autres | Others

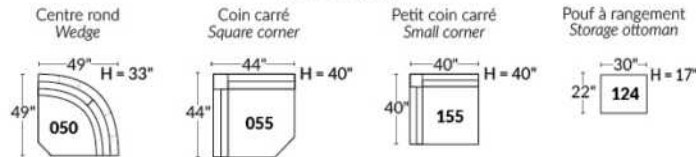

### EXEMPLE 23" EXAMPLE

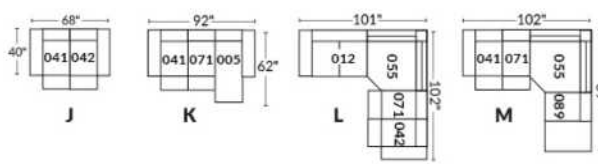

### EXEMPLE 30" EXAMPLE

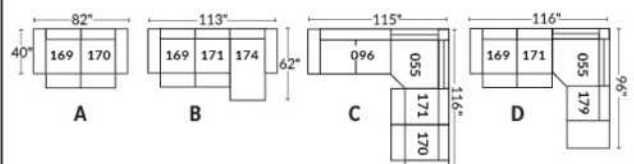

## BRUXELLES

### FEATURES:

- Manual adjustable headrest on all items (2 on square corner & stationary on wedge).
- \*Wall hugger power recliners with full footrest (manual n/a).
- Power recliner lounge chair (manual n/a) with power headrest in option. Wall clearance 8" & front 5".
- Seat cushions with shaped foam + 1" layer of memory foam on top; arm with memory foam.
- Stitching: Small thread in fabric & large flat thread in leather.
- \*Excludes 043 & 163 chairs: Wall clearance 16"

Note: 2 recliner seats separated by a corner can not be opened at the same time. No recliner seats beside #155 Small Square Corner.

### OPTIONS

- Battery Pack: Add \$160/ea.
- \*Motorized headrest: Add \$160 ea. (\*N/A on stationary items).
- Foam: Extra firm add \$15 /seat.
- Choice of arms: (Large or the Small 6" Arm): Leg on LARGE arm: LG103 wood, Metal: LG189 cyl. (Black or Chrome). SMALL Arm: LG08 wood, Metal: LG196 cyl. (Black or Chrome) or LG64 (sq). Specify colour.
- Seat Depth: 20" or \*22". \*22" seat depth N/A on chairs 043 & 163.
- 043 & 163 Chairs: with wood base (specify colour).

### HOME THEATRE Configurations

For Accessories, Cup holders & Configuration details, see Optima Home Theatre page attached.

Accessory Dock : \$35 ea.

Cup Holders: Metal: \$25 ea. | LED lighted Cup Holder: \$25 ea. | \*LED lighted Cup Holder with (1 or 2 motor) controls: \$40 ea.

\*LED Light strip under seat: \$25/seat.

| Description                        | L x D x H   | Leather |                       |  |  |                                  |                           | Fabric |          |           |
|------------------------------------|-------------|---------|-----------------------|--|--|----------------------------------|---------------------------|--------|----------|-----------|
|                                    |             | 10      | 20<br>Madras<br>Softy | 30<br>Hugo<br>Fantasy<br>Illusion<br>Tucson<br>Utah<br>Vintage<br>Wild Laredo<br>Yukon | 40<br>Elegance<br>Princess<br>Santiago<br>Sensation<br>Sunset<br>Trina<br>Victoria | 50<br>Bull<br>Cassiope<br>Dublin | 60<br>Caress<br>Ultrasued | A      | B<br>COM | C<br>alta |
| 001 CHAIR                          | 44x40x33/40 | 1890    | 1980                  | 2070   | 2160   | 2250                             | 2340                      | 1535   | 1580     | 1625      |
| 002 LOVESEAT                       | 67x40x33/40 | 2700    | 2815                  | 2930   | 3045   | 3160                             | 3275                      | 2175   | 2250     | 2325      |
| 003 SOFA                           | 91x40x33/40 | 3265    | 3415                  | 3565   | 3715   | 3865                             | 4015                      | 2625   | 2715     | 2805      |
| 005 LOUNGE CHAIR RIGHT ARM         | 34x62x33/40 | 1765    | 1830                  | 1895   | 1960   | 2025                             | 2090                      | 1410   | 1470     | 1530      |
| 009 ARMLESS LOVESEAT               | 47x40x33/40 | 1895    | 1965                  | 2035   | 2105   | 2175                             | 2245                      | 1490   | 1570     | 1650      |
| 011 LOUNGE CHAIR LEFT ARM          | 34x62x33/40 | 1765    | 1830                  | 1895   | 1960   | 2025                             | 2090                      | 1410   | 1470     | 1530      |
| 012 LOVESEAT LEFT ARM              | 57x40x33/40 | 2320    | 2420                  | 2520   | 2620   | 2720                             | 2820                      | 1850   | 1925     | 2000      |
| 017 DOUBLE CHAIR                   | 51x40x33/40 | 1980    | 2080                  | 2180   | 2280   | 2380                             | 2480                      | 1600   | 1660     | 1720      |
| 021 APARTMENT SOFA NO ARM          | 61x40x33/40 | 2140    | 2240                  | 2340   | 2440   | 2540                             | 2640                      | 1670   | 1755     | 1840      |
| 040 ARMLESS SOFA                   | 71x40x33/40 | 2450    | 2565                  | 2680   | 2795   | 2910                             | 3025                      | 1950   | 2040     | 2130      |
| 041 RECLINING CHAIR LEFT ARM       | 34x40x33/40 | 1885    | 1960                  | 2035   | 2110   | 2185                             | 2260                      | 1605   | 1640     | 1675      |
| 042 RECLINING CHAIR RIGHT ARM      | 34x40x33/40 | 1885    | 1960                  | 2035   | 2110   | 2185                             | 2260                      | 1605   | 1640     | 1675      |
| 043 SWIVEL ROCKING RECLINING CHAIR | 30x34x42    | 2235    | 2345                  | 2455   | 2565   | 2675                             | 2785                      | 1875   | 1920     | 1965      |
| 044 RECLINER CHAIR                 | 44x40x33/40 | 2275    | 2365                  | 2455   | 2545   | 2635                             | 2725                      | 1920   | 1970     | 2020      |
| 045 ARMLESS LOVESEAT BUMPER RIGHT  | 68x40x33/40 | 2245    | 2340                  | 2435   | 2530   | 2625                             | 2720                      | 1785   | 1850     | 1915      |
| 050 WEDGE                          | 49x49x33    | 1645    | 1745                  | 1845   | 1945   | 2045                             | 2145                      | 1210   | 1270     | 1330      |

## BRUXELLES

### FEATURES:

- Manual adjustable headrest on all items (2 on square corner & stationary on wedge).
- \*Wall hugger power recliners with full footrest (manual n/a).
- Power recliner lounge chair (manual n/a) with power headrest in option. Wall clearance 8" & front 5".
- Seat cushions with shaped foam + 1" layer of memory foam on top; arm with memory foam.
- Stitching: Small thread in fabric & large flat thread in leather.
- \*Excludes 043 & 163 chairs: Wall clearance 16"

Note: 2 recliner seats separated by a corner can not be opened at the same time. No recliner seats beside #155 Small Square Corner.

### OPTIONS

- Battery Pack: Add \$160/ea.
- \*Motorized headrest: Add \$160 ea. (\*N/A on stationary items).
- Foam: Extra firm add \$15 /seat.
- Choice of arms: (Large or the Small 6" Arm): Leg on LARGE arm: LG103 wood, Metal: LG189 cyl. (Black or Chrome). SMALL Arm: LG08 wood, Metal: LG196 cyl. (Black or Chrome) or LG64 (sq). Specify colour.
- Seat Depth: 20" or \*22". \*22" seat depth N/A on chairs 043 & 163.
- 043 & 163 Chairs: with wood base (specify colour).

### HOME THEATRE Configurations

For Accessories, Cup holders & Configuration details, see Optima Home Theatre page attached.

Accessory Dock : \$35 ea.

Cup Holders: Metal: \$25 ea. | LED lighted Cup Holder: \$25 ea. | \*LED lighted Cup Holder with (1 or 2 motor) controls: \$40 ea.

\*LED Light strip under seat: \$25/seat.

| Description                      | L x D x H     | Leather |                       |  |  |                                  |                            | Fabric |          |           |
|----------------------------------|---------------|---------|-----------------------|--|--|----------------------------------|----------------------------|--------|----------|-----------|
|                                  |               | 10      | 20<br>Madras<br>Softy | 30<br>Hugo<br>Fantasy<br>Illusion<br>Tucson<br>Utah<br>Vintage<br>Wild Laredo<br>Yukon | 40<br>Elegance<br>Princess<br>Santiago<br>Sensation<br>Sunset<br>Trina<br>Victoria | 50<br>Bull<br>Cassiope<br>Dublin | 60<br>Caresse<br>Ultrasued | A      | B<br>COM | C<br>alta |
| 051 ARMLESS CHAIR                | 23,5x40x33/40 | 1085    | 1135                  | 1185   | 1235   | 1285                             | 1335                       | 845    | 900      | 955       |
| 052 SOFA LEFT ARM                | 81x40x33/40   | 2870    | 3005                  | 3140   | 3275   | 3410                             | 3545                       | 2290   | 2385     | 2480      |
| 053 SOFA RIGHT ARM               | 81x40x33/40   | 2870    | 3005                  | 3140   | 3275   | 3410                             | 3545                       | 2290   | 2385     | 2480      |
| 055 SQUARE CORNER                | 44x44x33/40   | 1915    | 2010                  | 2105   | 2200   | 2295                             | 2390                       | 1510   | 1565     | 1620      |
| 056 CHAIR RIGHT ARM              | 34x40x33/40   | 1510    | 1575                  | 1640   | 1705   | 1770                             | 1835                       | 1200   | 1260     | 1320      |
| 057 CHAIR LEFT ARM               | 34x40x33/40   | 1510    | 1575                  | 1640   | 1705   | 1770                             | 1835                       | 1200   | 1260     | 1320      |
| 061 LOVESEAT RIGHT ARM           | 57x40x33/40   | 2320    | 2420                  | 2520   | 2620   | 2720                             | 2820                       | 1850   | 1925     | 2000      |
| 071 ARMLESS RECLINING CHAIR      | 23,5x40x33/40 | 1470    | 1525                  | 1580   | 1635   | 1690                             | 1745                       | 1250   | 1310     | 1370      |
| 086 ARMLESS LOVESEAT BUMPER LEFT | 68x40x33/40   | 2245    | 2340                  | 2435   | 2530   | 2625                             | 2720                       | 1785   | 1850     | 1915      |
| 088 ARMLESS CHAIR BUMPER LEFT    | 45x40x33/40   | 1440    | 1535                  | 1630   | 1725   | 1820                             | 1915                       | 1130   | 1165     | 1200      |
| 089 ARMLESS CHAIR BUMPER RIGHT   | 45x40x33/40   | 1440    | 1535                  | 1630   | 1725   | 1820                             | 1915                       | 1130   | 1165     | 1200      |
| 095 APARTMENT SOFA               | 81x40x33/40   | 2940    | 3085                  | 3230   | 3375   | 3520                             | 3665                       | 2350   | 2445     | 2540      |
| 096 APARTMENT SOFA LEFT ARM      | 71x40x33/40   | 2570    | 2680                  | 2790   | 2900   | 3010                             | 3120                       | 2020   | 2110     | 2200      |
| 097 APARTMENT SOFA RIGHT ARM     | 71x40x33/40   | 2570    | 2680                  | 2790   | 2900   | 3010                             | 3120                       | 2020   | 2110     | 2200      |
| 124 STORAGE OTTOMAN              | 30x22x17      | 745     | 765                   | 785  | 805  | 825                              | 845                        | 650    | 670      | 690       |
| 138 STRAIGHT ARM                 | 10x36x24.5    | 415     | 450                   | 485  | 520  | 555                              | 590                        | 350    | 365      | 380       |

## BRUXELLES

**FEATURES:**

- Manual adjustable headrest on all items (2 on square corner & stationary on wedge).
- \*Wall hugger power recliners with full footrest (manual n/a).
- Power recliner lounge chair (manual n/a) with power headrest in option. Wall clearance 8" & front 5".
- Seat cushions with shaped foam + 1" layer of memory foam on top; arm with memory foam.
- Stitching: Small thread in fabric & large flat thread in leather.
- \*Excludes 043 & 163 chairs: Wall clearance 16"

Note: 2 recliner seats separated by a corner can not be opened at the same time. No recliner seats beside #155 Small Square Corner.

**OPTIONS**

- Battery Pack: Add \$160/ea.
- \*Motorized headrest: Add \$160 ea. (\*N/A on stationary items).
- Foam: Extra firm add \$15 /seat.
- Choice of arms: (Large or the Small 6" Arm): Leg on LARGE arm: LG103 wood, Metal: LG189 cyl. (Black or Chrome). SMALL Arm: LG08 wood, Metal: LG196 cyl. (Black or Chrome) or LG64 (sq). Specify colour.
- Seat Depth: 20" or \*22". \*22" seat depth N/A on chairs 043 & 163.
- 043 & 163 Chairs: with wood base (specify colour).

**HOME THEATRE Configurations**

For Accessories, Cup holders & Configuration details, see Optima Home Theatre page attached.

Accessory Dock : \$35 ea.

Cup Holders: Metal: \$25 ea. | LED lighted Cup Holder: \$25 ea. | \*LED lighted Cup Holder with (1 or 2 motor) controls: \$40 ea.

\*LED Light strip under seat: \$25/seat.

| Description                            | L x D x H     | Leather |                       |  |  |                                  |                           | Fabric |          |           |
|--|---------------|---------|-----------------------|--|--|----------------------------------|---------------------------|--------|----------|-----------|
|  |               | 10      | 20<br>Madras<br>Softy | 30<br>Hugo<br>Fantasy<br>Illusion<br>Tucson<br>Utah<br>Vintage<br>Wild Laredo<br>Yukon | 40<br>Elegance<br>Princess<br>Santiago<br>Sensation<br>Sunset<br>Trina<br>Victoria | 50<br>Bull<br>Cassiope<br>Dublin | 60<br>Caress<br>Ultrasued | A      | B<br>COM | C<br>alta |
| 155 SMALL SQUARE CORNER                | 40x40x33/40   | 1915    | 2010                  | 2105   | 2200   | 2295                             | 2390                      | 1510   | 1565     | 1620      |
| 159 WEDGE STORAGE                      | 11/27x36x24.5 | 745     | 775                   | 805  | 835  | 865                              | 895                       | 585    | 600      | 615       |
| 160 STRAIGHT STORAGE                   | 11x36x24.5    | 720     | 745                   | 770  | 795  | 820                              | 845                       | 550    | 570      | 590       |
| 163 DBL SWIVEL ROCKING RECLINER CHAIR  | 33x34x42      | 2290    | 2410                  | 2530   | 2650   | 2770                             | 2890                      | 1880   | 1930     | 1980      |
| 165 DOUBLE RECLINING CHAIR             | 51x40x33/40   | 2375    | 2475                  | 2575   | 2675   | 2775                             | 2875                      | 2000   | 2065     | 2130      |
| 167 APARTMENT SOFA NO ARM BUMPER LEFT  | 82x40x33/40   | 2490    | 2620                  | 2750   | 2880   | 3010                             | 3140                      | 1960   | 2045     | 2130      |
| 168 APARTMENT SOFA NO ARM BUMPER RIGHT | 82x40x33/40   | 2490    | 2620                  | 2750   | 2880   | 3010                             | 3140                      | 1960   | 2045     | 2130      |
| 169 DOUBLE RECLINING CHAIR LEFT ARM    | 41x40x33/40   | 1990    | 2070                  | 2150   | 2230   | 2310                             | 2390                      | 1670   | 1750     | 1830      |
| 170 DOUBLE RECLINING CHAIR RIGHT ARM   | 41x40x33/40   | 1990    | 2070                  | 2150   | 2230   | 2310                             | 2390                      | 1670   | 1750     | 1830      |
| 171 ARMLESS DOUBLE RECLINING CHAIR     | 30,5x40x33/40 | 1575    | 1625                  | 1675   | 1725   | 1775                             | 1825                      | 1320   | 1380     | 1440      |
| 173 DOUBLE LOUNGE CHAIR LEFT ARM       | 41x62x33/40   | 1915    | 2005                  | 2095   | 2185   | 2275                             | 2365                      | 1535   | 1615     | 1695      |
| 174 DOUBLE LOUNGE CHAIR RIGHT ARM      | 41x62x33/40   | 1915    | 2005                  | 2095   | 2185   | 2275                             | 2365                      | 1535   | 1615     | 1695      |
| 175 DOUBLE CHAIR LEFT ARM              | 41x40x33/40   | 1590    | 1680                  | 1770   | 1860   | 1950                             | 2040                      | 1285   | 1350     | 1415      |
| 176 DOUBLE CHAIR RIGHT ARM             | 41x40x33/40   | 1590    | 1680                  | 1770   | 1860   | 1950                             | 2040                      | 1285   | 1350     | 1415      |
| 177 ARMLESS DOUBLE CHAIR               | 30,5x40x33/40 | 1185    | 1250                  | 1315   | 1380   | 1445                             | 1510                      | 915    | 970      | 1025      |
| 178 ARMLESS DOUBLE CHAIR BUMPER LEFT   | 52x40x33/40   | 1545    | 1625                  | 1705   | 1785   | 1865                             | 1945                      | 1230   | 1290     | 1350      |

## BRUXELLES

**FEATURES:**

- Manual adjustable headrest on all items (2 on square corner & stationary on wedge).
- \*Wall hugger power recliners with full footrest (manual n/a).
- Power recliner lounge chair (manual n/a) with power headrest in option. Wall clearance 8" & front 5".
- Seat cushions with shaped foam + 1" layer of memory foam on top; arm with memory foam.
- Stitching: Small thread in fabric & large flat thread in leather.
- \*Excludes 043 & 163 chairs: Wall clearance 16"

Note: 2 recliner seats separated by a corner can not be opened at the same time. No recliner seats beside #155 Small Square Corner.

**OPTIONS**

- Battery Pack: Add \$160/ea.
- \*Motorized headrest: Add \$160 ea. (\*N/A on stationary items).
- Foam: Extra firm add \$15 /seat.
- Choice of arms: (Large or the Small 6" Arm): Leg on LARGE arm: LG103 wood, Metal: LG189 cyl. (Black or Chrome). SMALL Arm: LG08 wood, Metal: LG196 cyl. (Black or Chrome) or LG64 (sq). Specify colour.
- Seat Depth: 20" or \*22". \*22" seat depth N/A on chairs 043 & 163.
- 043 & 163 Chairs: with wood base (specify colour).

**HOME THEATRE Configurations**

For Accessories, Cup holders & Configuration details, see Optima Home Theatre page attached.

Accessory Dock : \$35 ea.

Cup Holders: Metal: \$25 ea. | LED lighted Cup Holder: \$25 ea. | \*LED lighted Cup Holder with (1 or 2 motor) controls: \$40 ea.

\*LED Light strip under seat: \$25/seat.

| Description                            | L x D x H       | Leather |                       |  |  |                                  |                           | Fabric |          |           |
|--|-----------------|---------|-----------------------|--|--|----------------------------------|---------------------------|--------|----------|-----------|
|  |                 | 10      | 20<br>Madras<br>Softy | 30<br>Hugo<br>Fantasy<br>Illusion<br>Tucson<br>Utah<br>Vintage<br>Wild Laredo<br>Yukon | 40<br>Elegance<br>Princess<br>Santiago<br>Sensation<br>Sunset<br>Trina<br>Victoria | 50<br>Bull<br>Cassiope<br>Dublin | 60<br>Caress<br>Ultrasued | A      | B<br>COM | C<br>alta |
| 179 ARMLESS DOUBLE CHAIR BUMPER RIGHT  | 52x40x33/40     | 1545    | 1625                  | 1705   | 1785   | 1865                             | 1945                      | 1230   | 1290     | 1350      |
| 186 ARMLESS LOVESEAT BUMPER STORAGE-L  | 68x40x33/40     | 2420    | 2500                  | 2580   | 2660   | 2740                             | 2820                      | 1950   | 2015     | 2080      |
| 187 ARMLESS LOVESEAT BUMPER STORAGE-R  | 68x40x33/40     | 2420    | 2500                  | 2580   | 2660   | 2740                             | 2820                      | 1950   | 2015     | 2080      |
| 188 ARMLESS CHAIR BUMPER STORAGE-L     | 45x40x33/40     | 1600    | 1690                  | 1780   | 1870   | 1960                             | 2050                      | 1295   | 1330     | 1365      |
| 189 ARMLESS CHAIR BUMPER STORAGE-R     | 45x40x33/40     | 1600    | 1690                  | 1780   | 1870   | 1960                             | 2050                      | 1295   | 1330     | 1365      |
| 190 SMALL WEDGE STORAGE                | 11/21x36x24.5   | 720     | 745                   | 770  | 795  | 820                              | 845                       | 550    | 570      | 590       |
| 221 ARMLESS DBL CHAIR BUMPER STORAGE-L | 52x40x33/40     | 1705    | 1790                  | 1875   | 1960   | 2045                             | 2130                      | 1390   | 1450     | 1510      |
| 222 ARMLESS DBL CHAIR BUMPER STORAGE-R | 52x40x33/40     | 1705    | 1790                  | 1875   | 1960   | 2045                             | 2130                      | 1390   | 1450     | 1510      |
| 223 APT SOFA NO ARM BUMPER STORAGE-L   | 82x40x33/40     | 2655    | 2785                  | 2915   | 3045   | 3175                             | 3305                      | 2120   | 2215     | 2310      |
| 224 APT SOFA NO ARM BUMPER STORAGE-R   | 82x40x33/40     | 2655    | 2785                  | 2915   | 3045   | 3175                             | 3305                      | 2120   | 2215     | 2310      |
| 236 RECLINING LOUNGE CHAIR LEFT ARM    | 34x62x33/40     | 2160    | 2225                  | 2290   | 2355   | 2420                             | 2485                      | 1820   | 1880     | 1940      |
| 237 RECLINING LOUNGE CHAIR RIGHT ARM   | 34x62x33/40     | 2160    | 2225                  | 2290   | 2355   | 2420                             | 2485                      | 1820   | 1880     | 1940      |
| 238 RECLINING DBL LOUNGE CHAIR L-ARM   | 41x62x33/40     | 2315    | 2405                  | 2495   | 2585   | 2675                             | 2765                      | 1940   | 2020     | 2100      |
| 239 RECLINING DBL LOUNGE CHAIR R-ARM   | 41x62x33/40     | 2315    | 2405                  | 2495   | 2585   | 2675                             | 2765                      | 1940   | 2020     | 2100      |
| V51 WINE GLASS HOLDER                  | 3.5 x 5.5 x 6.5 | 35      | 35                    | 35   | 35   | 35                               | 35                        | 35     | 35       | 35        |
| V52 PLASTIC SWIVEL TRAY                | 13 3/8 x 9 5/8  | 35      | 35                    | 35   | 35   | 35                               | 35                        | 35     | 35       | 35        |



## BRUXELLES

**FEATURES:**

- Manual adjustable headrest on all items (2 on square corner & stationary on wedge).
- \*Wall hugger power recliners with full footrest (manual n/a).
- Power recliner lounge chair (manual n/a) with power headrest in option. Wall clearance 8" & front 5".
- Seat cushions with shaped foam + 1" layer of memory foam on top; arm with memory foam.
- Stitching: Small thread in fabric & large flat thread in leather.
- \*Excludes 043 & 163 chairs: Wall clearance 16"

Note: 2 recliner seats separated by a corner can not be opened at the same time. No recliner seats beside #155 Small Square Corner.

**OPTIONS**

- Battery Pack: Add \$160/ea.
- \*Motorized headrest: Add \$160 ea. (\*N/A on stationary items).
- Foam: Extra firm add \$15 /seat.
- Choice of arms: (Large or the Small 6" Arm): Leg on LARGE arm: LG103 wood, Metal: LG189 cyl. (Black or Chrome). SMALL Arm: LG08 wood, Metal: LG196 cyl. (Black or Chrome) or LG64 (sq). Specify colour.
- Seat Depth: 20" or \*22". \*22" seat depth N/A on chairs 043 & 163.
- 043 & 163 Chairs: with wood base (specify colour).

**HOME THEATRE Configurations**

For Accessories, Cup holders & Configuration details, see Optima Home Theatre page attached.

Accessory Dock : \$35 ea.

Cup Holders: Metal: \$25 ea. | LED lighted Cup Holder: \$25 ea. | \*LED lighted Cup Holder with (1 or 2 motor) controls: \$40 ea.

\*LED Light strip under seat: \$25/seat.

| Description                 | L x D x H          | Leather |                       |  |  |                                  |                           | Fabric |          |           |
|-----------------------------|--------------------|---------|-----------------------|--|--|----------------------------------|---------------------------|--------|----------|-----------|
|                             |                    | 10      | 20<br>Madras<br>Softy | 30<br>Hugo<br>Fantasy<br>Illusion<br>Tucson<br>Utah<br>Vintage<br>Wild Laredo<br>Yukon | 40<br>Elegance<br>Princess<br>Santiago<br>Sensation<br>Sunset<br>Trina<br>Victoria | 50<br>Bull<br>Cassiope<br>Dublin | 60<br>Caress<br>Ultrasued | A      | B<br>COM | C<br>alta |
| V53 WOOD SWIVEL TRAY        | 19 x 10            | 60      | 60                    | 60   | 60   | 60                               | 60                        | 60     | 60       | 60        |
| V54 TABLET HOLDER           | 4.5 x 8 x 10       | 40      | 40                    | 40   | 40   | 40                               | 40                        | 40     | 40       | 40        |
| V55 LED LAMP                | 1.5x5x14 pli /bent | 35      | 35                    | 35   | 35   | 35                               | 35                        | 35     | 35       | 35        |
| <b>CONFIGURATIONS</b>       |                    |         |                       |  |  |                                  |                           |        |          |           |
| _A CONFIG (169-170)         | 82X40X40           | 3980    | 4140                  | 4300   | 4460   | 4620                             | 4780                      | 3340   | 3500     | 3660      |
| _B CONFIG (169-171-174)     | 113X62X40          | 5480    | 5700                  | 5920   | 6140   | 6360                             | 6580                      | 4525   | 4745     | 4965      |
| _C CONFIG (096-055-171-170) | 115X115X40         | 8050    | 8385                  | 8720   | 9055   | 9390                             | 9725                      | 6520   | 6805     | 7090      |
| _D CONFIG (169-171-055-179) | 115X96X40          | 7025    | 7330                  | 7635   | 7940   | 8245                             | 8550                      | 5730   | 5985     | 6240      |
| _J CONFIG (041-042)         | 68X40X40           | 3770    | 3920                  | 4070   | 4220   | 4370                             | 4520                      | 3210   | 3280     | 3350      |
| _K CONFIG (041-071-005)     | 92X62X40           | 5120    | 5315                  | 5510   | 5705   | 5900                             | 6095                      | 4265   | 4420     | 4575      |
| _L CONFIG (012-055-071-042) | 102X102X40         | 7590    | 7915                  | 8240   | 8565   | 8890                             | 9215                      | 6215   | 6440     | 6665      |
| _M CONFIG (041-071-055-089) | 102X89X40          | 6710    | 7030                  | 7350   | 7670   | 7990                             | 8310                      | 5495   | 5680     | 5865      |



# BRUXELLES

**OPTIMA**  
Collection

**Jaymar**

Conçu et fabriqué fièrement au Canada  
Proudly designed and made in Canada

Nos produits sont fabriqués à la main et des variations mineures peuvent survenir

Our product is hand-made and minor variations can occur.

## SPECIFICATIONS

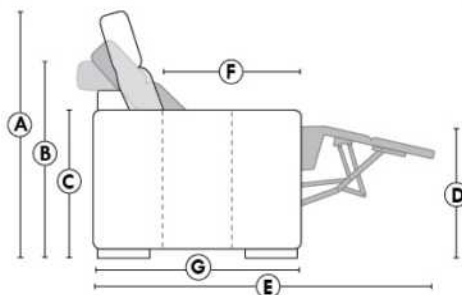

- Appui-tête levé Headrest up
- Appui-tête baissé Headrest down
- Complètement incliné Fully reclined

- A** Hauteur complète 40" Total Height
- B** Hauteur appui-tête baissé 33" Height headrest down
- C** Hauteur du bras 24,5" Arm Height
- D** Hauteur du siège 19,5" Seat height
- E** Profondeur inclinée 65" Depth fully reclined
- F** Profondeur d'assise 20"ou/ou 22" Seat depth
- G** Profondeur appui-tête monté 37,5" Depth with headrest up

## BRAS | ARMS

Option de bras:  
Bras Régulier Large 10" ou Petit bras 6"

Arm option  
Regular arm Large 10" or Small arm 6"

Contrôle de l'inclinaison situé à l'intérieur du bras  
Recliner control located on the inside of the arm.

Option d'accessoires disponible sur le bras régulier seulement  
Accessories option, available on Regular arms ONLY.

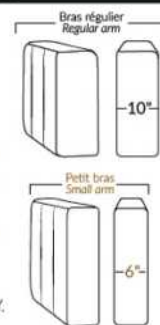

## FAUTEUIL BERÇANT PIVOTANT INCLINABLE SWIVEL ROCKING MOTION CHAIR

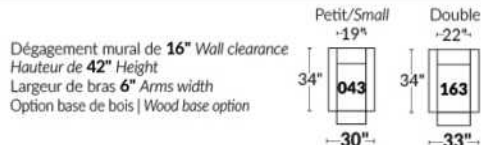

## SIÈGE 23" DE LARGE | 23" SEAT WIDTH

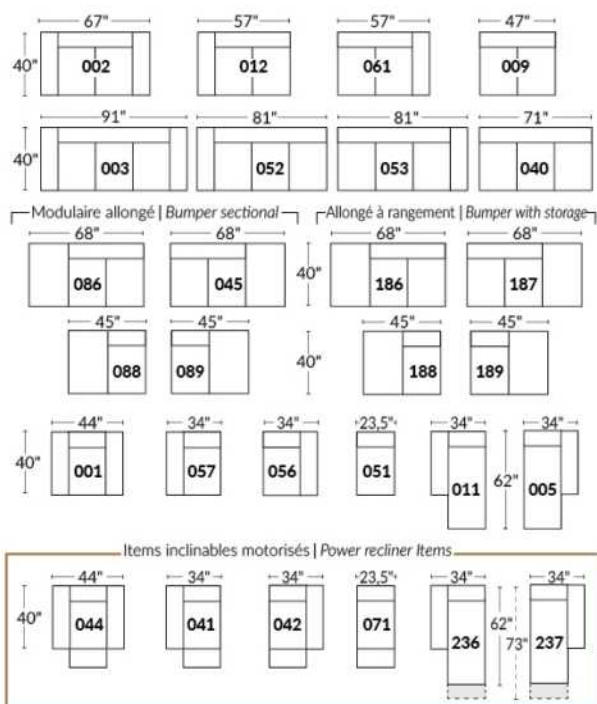

## SIÈGE 30" DE LARGE | 30" SEAT WIDTH

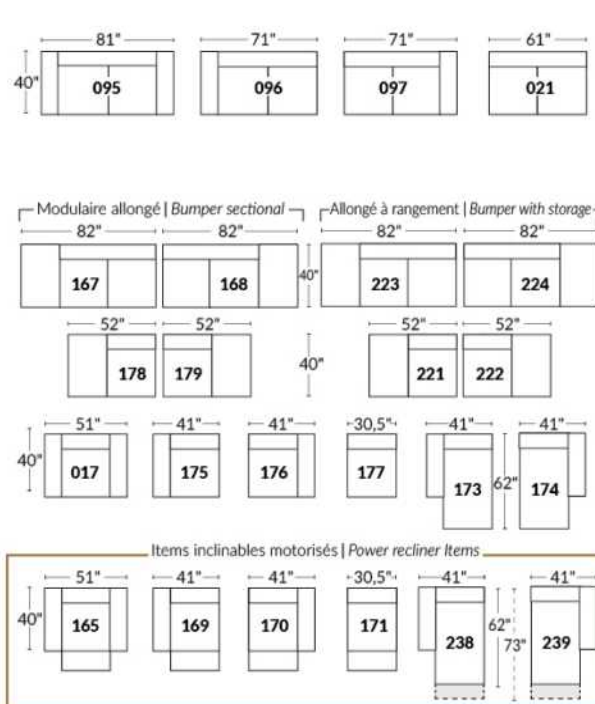

### Autres | Others

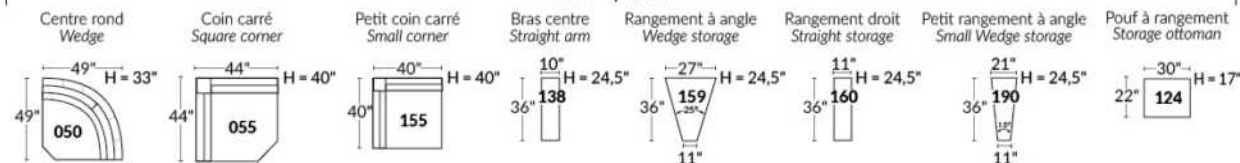

### EXEMPLE 23" EXAMPLE

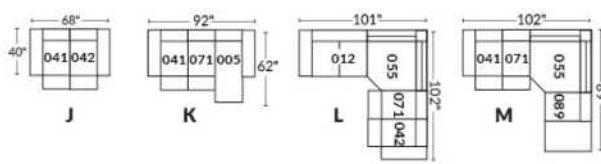

### EXEMPLE 30" EXAMPLE

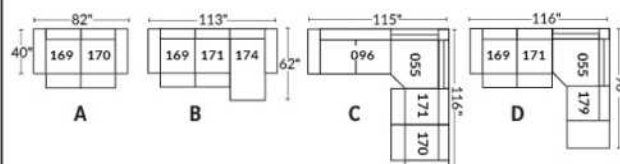

\*Available on certain models and on large arms ONLY.

### OPTIONS CUP HOLDERS

#### METAL



Silver



Matte Black



Brown

#### ILLUMINATED

1.



LED Lighted Cup holder

2.



LED Lighted Cup holder with Single Motor Control, USB Port and LED Base rail

3.



LED Lighted Cup holder with Dual Motor Control, USB Port and LED Base rail

Our illuminated one or two-control cup holders are compatible with LED lights under the seat. You can control the light on the cup holder. The 2 motor cup holder has a reset (home) button control to close your recliner back to its starting position.

#### LED Light under seat (Optional)

Available only in configurations with a minimum of 1 illuminated motorized cup holder with control buttons. The "light" button will control the opening and closing of the light.

For cup holder prices see description section of the Optima model price list.

Please provide us with a drawing of your configuration which indicates the cup holder type and its positioning.

#### Cup holder with controller:

It is important to specify the placement of the cups; on left arm or right arm and which recliner they will control. If you have a row of several seats with cup holders, by default, the controls will be on the left arms and on the right arm for the last outer chair.

#### EXAMPLE A:

041-169: Controller and cup holder on the left arm

071-171: hidden touch sensor buttons on side of seat

042-170: Controller and cup holder on right arm



#### EXAMPLE B:

071-171: These two items can be connected to a smart cup holder which will control the recliner. You must then use one of these items: 138, 159, 160 and 190



#### Informations about headrest, controller on reclining seat

#### WITH illuminated cup holder

If you have a **stationary item**, you will have cup holder N°1.

If you have a recliner chair with a **manual headrest**, you will have the cup holder N°2.

If you have a recliner chair with an **electric headrest**, you will have cup holder N°3.

#### Without cup holder and with a reclining seat

If you have a recliner with a **manual headrest** you will have the touch sensor button control on the side of the seat.

If you have a recliner with an **electric headrest** you will have a dual push button controller with USB port on the arm.

If you have an **armless recliner**, you will have the hidden touch sensor button control.



Hidden touch sensor



Dual push button

# OPTIMA

## HOME THEATRE Configurations

\*Available on certain models and on large arms ONLY.

OPTIONS

### ACCESSORIES

Accessory Dock



V51 Wine Glass Holder



V52 Plastic Swivel Tray Table



V53 Wood Swivel tray Table  
(Choice of 8 colors)



Specify on which arm (left or right) the tray table will be installed.

V54 Tablet Holder



V55 LED Lamp



(For Accessory Dock price, see description section of the Optima model price list and for Accessory item prices, see at very end of the price list)

### Items 138-159-160-190 and large arm.

Accessory docks and cups are Optional. \*Not available on small arms\*

Please specify on which arms you want the accessory docks and cup holders.

NB: Item 138-159-160-190 are unfinished on the sides, must be used between 2 seats.

Each storage item has 2 USB ports and one electrical outlet inside the storage.



### SUGGESTED CONFIGURATIONS



## BUDAPEST

**FEATURES:**

- Manual adjustable headrest on all items (2 on square corner & stationary on wedge).
- \*Wall hugger power recliners with full footrest (manual n/a).
- Power recliner lounge chair (manual n/a) with power headrest in option. Wall clearance 8" & front 5".
- Seat cushions with shaped foam + 1" layer of memory foam on top; arm with memory foam.
- Stitching: Small thread in fabric & large flat thread in leather.

\*Excludes 043 & 163 chairs: Wall clearance 16"

Note: 2 recliner seats separated by a corner can not be opened at the same time. No recliner seats beside #155 Small Square Corner.

**OPTIONS**

Battery Pack: ADD \$160/ea.

\*Motorized headrest: ADD \$160 ea. (\*N/A on stationary items).

Foam: Extra firm add \$15 /seat.

Choice of Large or Small 6" Arm: Leg on LARGE arm: LG103 wood or LG189 metal (Black or Chrome). SMALL Arm: LG08 wood or Metal: LG196 cyl. (Black or Chrome) or LG64 (sq). Specify colour.

Seat Depth: 20" or \*22". \*22" seat depth N/A on chairs 043 & 163.

043 & 163 Chairs: with wood base (specify colour).

**HOME THEATRE Configurations**

For Accessories, Cup holders & Configuration details, see Optima Home Theatre page attached.

Accessory Dock : \$35 ea.

Cup Holders: Metal: \$25 ea. | LED lighted Cup Holder: \$25 ea. | \*LED lighted Cup Holder with (1 or 2 motor) controls: \$40 ea.

\*LED Light strip under seat: \$25/seat.

| Description                        | L x D x H   | Leather |                       |  |  |                                  |                           | Fabric |          |           |
|------------------------------------|-------------|---------|-----------------------|--|--|----------------------------------|---------------------------|--------|----------|-----------|
|                                    |             | 10      | 20<br>Madras<br>Softy | 30<br>Hugo<br>Fantasy<br>Illusion<br>Tucson<br>Utah<br>Vintage<br>Wild Laredo<br>Yukon | 40<br>Elegance<br>Princess<br>Santiago<br>Sensation<br>Sunset<br>Trina<br>Victoria | 50<br>Bull<br>Cassiope<br>Dublin | 60<br>Caress<br>Ultrasued | A      | B<br>COM | C<br>alta |
| 001 CHAIR                          | 44x40x33/40 | 1890    | 1980                  | 2070   | 2160   | 2250                             | 2340                      | 1535   | 1580     | 1625      |
| 002 LOVESEAT                       | 67x40x33/40 | 2700    | 2815                  | 2930   | 3045   | 3160                             | 3275                      | 2175   | 2250     | 2325      |
| 003 SOFA                           | 91x40x33/40 | 3265    | 3415                  | 3565   | 3715   | 3865                             | 4015                      | 2625   | 2715     | 2805      |
| 005 LOUNGE CHAIR RIGHT ARM         | 34x62x33/40 | 1765    | 1830                  | 1895   | 1960   | 2025                             | 2090                      | 1410   | 1470     | 1530      |
| 009 ARMLESS LOVESEAT               | 47x40x33/40 | 1895    | 1965                  | 2035   | 2105   | 2175                             | 2245                      | 1490   | 1570     | 1650      |
| 011 LOUNGE CHAIR LEFT ARM          | 34x62x33/40 | 1765    | 1830                  | 1895   | 1960   | 2025                             | 2090                      | 1410   | 1470     | 1530      |
| 012 LOVESEAT LEFT ARM              | 57x40x33/40 | 2320    | 2420                  | 2520   | 2620   | 2720                             | 2820                      | 1850   | 1925     | 2000      |
| 017 DOUBLE CHAIR                   | 51x40x33/40 | 1980    | 2080                  | 2180   | 2280   | 2380                             | 2480                      | 1600   | 1660     | 1720      |
| 021 APARTMENT SOFA NO ARM          | 61x40x33/40 | 2140    | 2240                  | 2340   | 2440   | 2540                             | 2640                      | 1670   | 1755     | 1840      |
| 040 ARMLESS SOFA                   | 71x40x33/40 | 2450    | 2565                  | 2680   | 2795   | 2910                             | 3025                      | 1950   | 2040     | 2130      |
| 041 RECLINING CHAIR LEFT ARM       | 34x40x33/40 | 1885    | 1960                  | 2035   | 2110   | 2185                             | 2260                      | 1605   | 1640     | 1675      |
| 042 RECLINING CHAIR RIGHT ARM      | 34x40x33/40 | 1885    | 1960                  | 2035   | 2110   | 2185                             | 2260                      | 1605   | 1640     | 1675      |
| 043 SWIVEL ROCKING RECLINING CHAIR | 30x34x42    | 2235    | 2345                  | 2455   | 2565   | 2675                             | 2785                      | 1875   | 1920     | 1965      |
| 044 RECLINER CHAIR                 | 44x40x33/40 | 2275    | 2365                  | 2455   | 2545   | 2635                             | 2725                      | 1920   | 1970     | 2020      |
| 045 ARMLESS LOVESEAT BUMPER RIGHT  | 68x40x33/40 | 2245    | 2340                  | 2435   | 2530   | 2625                             | 2720                      | 1785   | 1850     | 1915      |
| 050 WEDGE                          | 49x49x33    | 1645    | 1745                  | 1845   | 1945   | 2045                             | 2145                      | 1210   | 1270     | 1330      |

## BUDAPEST

### FEATURES:

- Manual adjustable headrest on all items (2 on square corner & stationary on wedge).
- \*Wall hugger power recliners with full footrest (manual n/a).
- Power recliner lounge chair (manual n/a) with power headrest in option. Wall clearance 8" & front 5".
- Seat cushions with shaped foam + 1" layer of memory foam on top; arm with memory foam.
- Stitching: Small thread in fabric & large flat thread in leather.
- \*Excludes 043 & 163 chairs: Wall clearance 16"

Note: 2 recliner seats separated by a corner can not be opened at the same time. No recliner seats beside #155 Small Square Corner.

### OPTIONS

Battery Pack: ADD \$160/ea.

\*Motorized headrest: ADD \$160 ea. (\*N/A on stationary items).

Foam: Extra firm add \$15 /seat.

Choice of Large or Small 6" Arm: Leg on LARGE arm: LG103 wood or LG189 metal (Black or Chrome). SMALL Arm: LG08 wood or Metal: LG196 cyl. (Black or Chrome) or LG64 (sq). Specify colour.

Seat Depth: 20" or \*22". \*22" seat depth N/A on chairs 043 & 163.

043 & 163 Chairs: with wood base (specify colour).

### HOME THEATRE Configurations

For Accessories, Cup holders & Configuration details, see Optima Home Theatre page attached.

Accessory Dock : \$35 ea.

Cup Holders: Metal: \$25 ea. | LED lighted Cup Holder: \$25 ea. | \*LED lighted Cup Holder with (1 or 2 motor) controls: \$40 ea.

\*LED Light strip under seat: \$25/seat.

| Description                      | L x D x H     | Leather |                       |  |  |                                  |                            | Fabric |          |           |
|----------------------------------|---------------|---------|-----------------------|--|--|----------------------------------|----------------------------|--------|----------|-----------|
|                                  |               | 10      | 20<br>Madras<br>Softy | 30<br>Hugo<br>Fantasy<br>Illusion<br>Tucson<br>Utah<br>Vintage<br>Wild Laredo<br>Yukon | 40<br>Elegance<br>Princess<br>Santiago<br>Sensation<br>Sunset<br>Trina<br>Victoria | 50<br>Bull<br>Cassiope<br>Dublin | 60<br>Caresse<br>Ultrasued | A      | B<br>COM | C<br>alta |
| 051 ARMLESS CHAIR                | 23,5x40x33/40 | 1085    | 1135                  | 1185   | 1235   | 1285                             | 1335                       | 845    | 900      | 955       |
| 052 SOFA LEFT ARM                | 81x40x33/40   | 2870    | 3005                  | 3140   | 3275   | 3410                             | 3545                       | 2290   | 2385     | 2480      |
| 053 SOFA RIGHT ARM               | 81x40x33/40   | 2870    | 3005                  | 3140   | 3275   | 3410                             | 3545                       | 2290   | 2385     | 2480      |
| 055 SQUARE CORNER                | 44x44x33/40   | 1915    | 2010                  | 2105   | 2200   | 2295                             | 2390                       | 1510   | 1565     | 1620      |
| 056 CHAIR RIGHT ARM              | 34x40x33/40   | 1510    | 1575                  | 1640   | 1705   | 1770                             | 1835                       | 1200   | 1260     | 1320      |
| 057 CHAIR LEFT ARM               | 34x40x33/40   | 1510    | 1575                  | 1640   | 1705   | 1770                             | 1835                       | 1200   | 1260     | 1320      |
| 061 LOVESEAT RIGHT ARM           | 57x40x33/40   | 2320    | 2420                  | 2520   | 2620   | 2720                             | 2820                       | 1850   | 1925     | 2000      |
| 071 ARMLESS RECLINING CHAIR      | 23,5x40x33/40 | 1470    | 1525                  | 1580   | 1635   | 1690                             | 1745                       | 1250   | 1310     | 1370      |
| 086 ARMLESS LOVESEAT BUMPER LEFT | 68x40x33/40   | 2245    | 2340                  | 2435   | 2530   | 2625                             | 2720                       | 1785   | 1850     | 1915      |
| 088 ARMLESS CHAIR BUMPER LEFT    | 45x40x33/40   | 1440    | 1535                  | 1630   | 1725   | 1820                             | 1915                       | 1130   | 1165     | 1200      |
| 089 ARMLESS CHAIR BUMPER RIGHT   | 45x40x33/40   | 1440    | 1535                  | 1630   | 1725   | 1820                             | 1915                       | 1130   | 1165     | 1200      |
| 095 APARTMENT SOFA               | 81x40x33/40   | 2940    | 3085                  | 3230   | 3375   | 3520                             | 3665                       | 2350   | 2445     | 2540      |
| 096 APARTMENT SOFA LEFT ARM      | 71x40x33/40   | 2570    | 2680                  | 2790   | 2900   | 3010                             | 3120                       | 2020   | 2110     | 2200      |
| 097 APARTMENT SOFA RIGHT ARM     | 71x40x33/40   | 2570    | 2680                  | 2790   | 2900   | 3010                             | 3120                       | 2020   | 2110     | 2200      |
| 124 STORAGE OTTOMAN              | 30x22x17      | 745     | 765                   | 785  | 805  | 825                              | 845                        | 650    | 670      | 690       |
| 138 STRAIGHT ARM                 | 10x36x24      | 415     | 450                   | 485  | 520  | 555                              | 590                        | 350    | 365      | 380       |



## BUDAPEST

**FEATURES:**

- Manual adjustable headrest on all items (2 on square corner & stationary on wedge).
- \*Wall hugger power recliners with full footrest (manual n/a).
- Power recliner lounge chair (manual n/a) with power headrest in option. Wall clearance 8" & front 5".
- Seat cushions with shaped foam + 1" layer of memory foam on top; arm with memory foam.
- Stitching: Small thread in fabric & large flat thread in leather.
- \*Excludes 043 & 163 chairs: Wall clearance 16"

Note: 2 recliner seats separated by a corner can not be opened at the same time. No recliner seats beside #155 Small Square Corner.

**OPTIONS**

Battery Pack: ADD \$160/ea.

\*Motorized headrest: ADD \$160 ea. (\*N/A on stationary items).

Foam: Extra firm add \$15 /seat.

Choice of Large or Small 6" Arm: Leg on LARGE arm: LG103 wood or LG189 metal (Black or Chrome). SMALL Arm: LG08 wood or Metal: LG196 cyl. (Black or Chrome) or LG64 (sq). Specify colour.

Seat Depth: 20" or \*22". \*22" seat depth N/A on chairs 043 & 163.

043 & 163 Chairs: with wood base (specify colour).

**HOME THEATRE Configurations**

For Accessories, Cup holders & Configuration details, see Optima Home Theatre page attached.

Accessory Dock : \$35 ea.

Cup Holders: Metal: \$25 ea. | LED lighted Cup Holder: \$25 ea. | \*LED lighted Cup Holder with (1 or 2 motor) controls: \$40 ea.

\*LED Light strip under seat: \$25/seat.

| Description                            | L x D x H     | Leather |                       |  |  |                                  |                           | Fabric |          |           |
|--|---------------|---------|-----------------------|--|--|----------------------------------|---------------------------|--------|----------|-----------|
|  |               | 10      | 20<br>Madras<br>Softy | 30<br>Hugo<br>Fantasy<br>Illusion<br>Tucson<br>Utah<br>Vintage<br>Wild Laredo<br>Yukon | 40<br>Elegance<br>Princess<br>Santiago<br>Sensation<br>Sunset<br>Trina<br>Victoria | 50<br>Bull<br>Cassiope<br>Dublin | 60<br>Caress<br>Ultrasued | A      | B<br>COM | C<br>alta |
| 155 SMALL SQUARE CORNER                | 40x40x33/40   | 1915    | 2010                  | 2105   | 2200   | 2295                             | 2390                      | 1510   | 1565     | 1620      |
| 159 WEDGE STORAGE                      | 11/27x36x24   | 745     | 775                   | 805  | 835  | 865                              | 895                       | 585    | 600      | 615       |
| 160 STRAIGHT STORAGE                   | 11x36x24      | 720     | 745                   | 770  | 795  | 820                              | 845                       | 550    | 570      | 590       |
| 163 DBL SWIVEL ROCKING RECLINER CHAIR  | 33x34x42      | 2290    | 2410                  | 2530   | 2650   | 2770                             | 2890                      | 1880   | 1930     | 1980      |
| 165 DOUBLE RECLINING CHAIR             | 51x40x33/40   | 2375    | 2475                  | 2575   | 2675   | 2775                             | 2875                      | 2000   | 2065     | 2130      |
| 167 APARTMENT SOFA NO ARM BUMPER LEFT  | 82x40x33/40   | 2490    | 2620                  | 2750   | 2880   | 3010                             | 3140                      | 1960   | 2045     | 2130      |
| 168 APARTMENT SOFA NO ARM BUMPER RIGHT | 82x40x33/40   | 2490    | 2620                  | 2750   | 2880   | 3010                             | 3140                      | 1960   | 2045     | 2130      |
| 169 DOUBLE RECLINING CHAIR LEFT ARM    | 41x40x33/40   | 1990    | 2070                  | 2150   | 2230   | 2310                             | 2390                      | 1670   | 1750     | 1830      |
| 170 DOUBLE RECLINING CHAIR RIGHT ARM   | 41x40x33/40   | 1990    | 2070                  | 2150   | 2230   | 2310                             | 2390                      | 1670   | 1750     | 1830      |
| 171 ARMLESS DOUBLE RECLINING CHAIR     | 30,5x40x33/40 | 1575    | 1625                  | 1675   | 1725   | 1775                             | 1825                      | 1320   | 1380     | 1440      |
| 173 DOUBLE LOUNGE CHAIR LEFT ARM       | 41x62x33/40   | 1915    | 2005                  | 2095   | 2185   | 2275                             | 2365                      | 1535   | 1615     | 1695      |
| 174 DOUBLE LOUNGE CHAIR RIGHT ARM      | 41x62x33/40   | 1915    | 2005                  | 2095   | 2185   | 2275                             | 2365                      | 1535   | 1615     | 1695      |
| 175 DOUBLE CHAIR LEFT ARM              | 41x40x33/40   | 1590    | 1680                  | 1770   | 1860   | 1950                             | 2040                      | 1285   | 1350     | 1415      |
| 176 DOUBLE CHAIR RIGHT ARM             | 41x40x33/40   | 1590    | 1680                  | 1770   | 1860   | 1950                             | 2040                      | 1285   | 1350     | 1415      |
| 177 ARMLESS DOUBLE CHAIR               | 30,5x40x33/40 | 1185    | 1250                  | 1315   | 1380   | 1445                             | 1510                      | 915    | 970      | 1025      |
| 178 ARMLESS DOUBLE CHAIR BUMPER LEFT   | 52x40x33/40   | 1545    | 1625                  | 1705   | 1785   | 1865                             | 1945                      | 1230   | 1290     | 1350      |

## BUDAPEST

**FEATURES:**

- Manual adjustable headrest on all items (2 on square corner & stationary on wedge).
- \*Wall hugger power recliners with full footrest (manual n/a).
- Power recliner lounge chair (manual n/a) with power headrest in option. Wall clearance 8" & front 5".
- Seat cushions with shaped foam + 1" layer of memory foam on top; arm with memory foam.
- Stitching: Small thread in fabric & large flat thread in leather.
- \*Excludes 043 & 163 chairs: Wall clearance 16"

Note: 2 recliner seats separated by a corner can not be opened at the same time. No recliner seats beside #155 Small Square Corner.

**OPTIONS**

Battery Pack: ADD \$160/ea.

\*Motorized headrest: ADD \$160 ea. (\*N/A on stationary items).

Foam: Extra firm add \$15 /seat.

Choice of Large or Small 6" Arm: Leg on LARGE arm: LG103 wood or LG189 metal (Black or Chrome). SMALL Arm: LG08 wood or Metal: LG196 cyl. (Black or Chrome) or LG64 (sq). Specify colour.

Seat Depth: 20" or \*22". \*22" seat depth N/A on chairs 043 & 163.

043 & 163 Chairs: with wood base (specify colour).

**HOME THEATRE Configurations**

For Accessories, Cup holders & Configuration details, see Optima Home Theatre page attached.

Accessory Dock : \$35 ea.

Cup Holders: Metal: \$25 ea. | LED lighted Cup Holder: \$25 ea. | \*LED lighted Cup Holder with (1 or 2 motor) controls: \$40 ea.

\*LED Light strip under seat: \$25/seat.

| Description                            | L x D x H       | Leather |                       |  |  |                                  |                           | Fabric |          |           |
|--|-----------------|---------|-----------------------|--|--|----------------------------------|---------------------------|--------|----------|-----------|
|  |                 | 10      | 20<br>Madras<br>Softy | 30<br>Hugo<br>Fantasy<br>Illusion<br>Tucson<br>Utah<br>Vintage<br>Wild Laredo<br>Yukon | 40<br>Elegance<br>Princess<br>Santiago<br>Sensation<br>Sunset<br>Trina<br>Victoria | 50<br>Bull<br>Cassiope<br>Dublin | 60<br>Caress<br>Ultrasued | A      | B<br>COM | C<br>alta |
| 179 ARMLESS DOUBLE CHAIR BUMPER RIGHT  | 52x40x33/40     | 1545    | 1625                  | 1705   | 1785   | 1865                             | 1945                      | 1230   | 1290     | 1350      |
| 186 ARMLESS LOVESEAT BUMPER STORAGE-L  | 68x40x33/40     | 2420    | 2500                  | 2580   | 2660   | 2740                             | 2820                      | 1950   | 2015     | 2080      |
| 187 ARMLESS LOVESEAT BUMPER STORAGE-R  | 68x40x33/40     | 2420    | 2500                  | 2580   | 2660   | 2740                             | 2820                      | 1950   | 2015     | 2080      |
| 188 ARMLESS CHAIR BUMPER STORAGE-L     | 45x40x33/40     | 1600    | 1690                  | 1780   | 1870   | 1960                             | 2050                      | 1295   | 1330     | 1365      |
| 189 ARMLESS CHAIR BUMPER STORAGE-R     | 45x40x33/40     | 1600    | 1690                  | 1780   | 1870   | 1960                             | 2050                      | 1295   | 1330     | 1365      |
| 190 SMALL WEDGE STORAGE                | 11/21x36x24     | 720     | 745                   | 770  | 795  | 820                              | 845                       | 550    | 570      | 590       |
| 221 ARMLESS DBL CHAIR BUMPER STORAGE-L | 52x40x33/40     | 1705    | 1790                  | 1875   | 1960   | 2045                             | 2130                      | 1390   | 1450     | 1510      |
| 222 ARMLESS DBL CHAIR BUMPER STORAGE-R | 52x40x33/40     | 1705    | 1790                  | 1875   | 1960   | 2045                             | 2130                      | 1390   | 1450     | 1510      |
| 223 APT SOFA NO ARM BUMPER STORAGE-L   | 82x40x33/40     | 2655    | 2785                  | 2915   | 3045   | 3175                             | 3305                      | 2120   | 2215     | 2310      |
| 224 APT SOFA NO ARM BUMPER STORAGE-R   | 82x40x33/40     | 2655    | 2785                  | 2915   | 3045   | 3175                             | 3305                      | 2120   | 2215     | 2310      |
| 236 RECLINING LOUNGE CHAIR LEFT ARM    | 34x62x33/40     | 2160    | 2225                  | 2290   | 2355   | 2420                             | 2485                      | 1820   | 1880     | 1940      |
| 237 RECLINING LOUNGE CHAIR RIGHT ARM   | 34x62x33/40     | 2160    | 2225                  | 2290   | 2355   | 2420                             | 2485                      | 1820   | 1880     | 1940      |
| 238 RECLINING DBL LOUNGE CHAIR L-ARM   | 41x62x33/40     | 2315    | 2405                  | 2495   | 2585   | 2675                             | 2765                      | 1940   | 2020     | 2100      |
| 239 RECLINING DBL LOUNGE CHAIR R-ARM   | 41x62x33/40     | 2315    | 2405                  | 2495   | 2585   | 2675                             | 2765                      | 1940   | 2020     | 2100      |
| V51 WINE GLASS HOLDER                  | 3.5 x 5.5 x 6.5 | 35      | 35                    | 35   | 35   | 35                               | 35                        | 35     | 35       | 35        |
| V52 PLASTIC SWIVEL TRAY                | 13 3/8 x 9 5/8  | 35      | 35                    | 35   | 35   | 35                               | 35                        | 35     | 35       | 35        |



## BUDAPEST

### FEATURES:

- Manual adjustable headrest on all items (2 on square corner & stationary on wedge).
- \*Wall hugger power recliners with full footrest (manual n/a).
- Power recliner lounge chair (manual n/a) with power headrest in option. Wall clearance 8" & front 5".
- Seat cushions with shaped foam + 1" layer of memory foam on top; arm with memory foam.
- Stitching: Small thread in fabric & large flat thread in leather.
- \*Excludes 043 & 163 chairs: Wall clearance 16"

Note: 2 recliner seats separated by a corner can not be opened at the same time. No recliner seats beside #155 Small Square Corner.

### OPTIONS

Battery Pack: ADD \$160/ea.

\*Motorized headrest: ADD \$160 ea. (\*N/A on stationary items).

Foam: Extra firm add \$15 /seat.

Choice of Large or Small 6" Arm: Leg on LARGE arm: LG103 wood or LG189 metal (Black or Chrome). SMALL Arm: LG08 wood or Metal: LG196 cyl. (Black or Chrome) or LG64 (sq). Specify colour.

Seat Depth: 20" or \*22". \*22" seat depth N/A on chairs 043 & 163.

043 & 163 Chairs: with wood base (specify colour).

### HOME THEATRE Configurations

For Accessories, Cup holders & Configuration details, see Optima Home Theatre page attached.

Accessory Dock : \$35 ea.

Cup Holders: Metal: \$25 ea. | LED lighted Cup Holder: \$25 ea. | \*LED lighted Cup Holder with (1 or 2 motor) controls: \$40 ea.

\*LED Light strip under seat: \$25/seat.

| Description                 | L x D x H          | Leather |                       |  |  |                                  |                           | Fabric |          |           |    |
|-----------------------------|--------------------|---------|-----------------------|--|--|----------------------------------|---------------------------|--------|----------|-----------|----|
|                             |                    | 10      | 20<br>Madras<br>Softy | 30<br>Hugo<br>Fantasy<br>Illusion<br>Tucson<br>Utah<br>Vintage<br>Wild Laredo<br>Yukon | 40<br>Elegance<br>Princess<br>Santiago<br>Sensation<br>Sunset<br>Trina<br>Victoria | 50<br>Bull<br>Cassiope<br>Dublin | 60<br>Caress<br>Ultrasued | A      | B<br>COM | C<br>alta |    |
| V53 WOOD SWIVEL TRAY        | 19 x 10            | 60      | 60                    | 60   | 60   | 60                               | 60                        | 60     | 60       | 60        | 60 |
| V54 TABLET HOLDER           | 4.5 x 8 x 10       | 40      | 40                    | 40   | 40   | 40                               | 40                        | 40     | 40       | 40        | 40 |
| V55 LED LAMP                | 1.5x5x14 plié/bent | 35      | 35                    | 35   | 35   | 35                               | 35                        | 35     | 35       | 35        | 35 |
| <b>CONFIGURATIONS</b>       |                    |         |                       |  |  |                                  |                           |        |          |           |    |
| _A CONFIG (169-170)         | 82X40X40           | 3980    | 4140                  | 4300   | 4460   | 4620                             | 4780                      | 3340   | 3500     | 3660      |    |
| _B CONFIG (169-171-174)     | 113X62X40          | 5480    | 5700                  | 5920   | 6140   | 6360                             | 6580                      | 4525   | 4745     | 4965      |    |
| _C CONFIG (096-055-171-170) | 115X115X40         | 8050    | 8385                  | 8720   | 9055   | 9390                             | 9725                      | 6520   | 6805     | 7090      |    |
| _D CONFIG (169-171-055-179) | 115X96X40          | 7025    | 7330                  | 7635   | 7940   | 8245                             | 8550                      | 5730   | 5985     | 6240      |    |
| _J CONFIG (041-042)         | 68X40X40           | 3770    | 3920                  | 4070   | 4220   | 4370                             | 4520                      | 3210   | 3280     | 3350      |    |
| _K CONFIG (041-071-005)     | 92X62X40           | 5120    | 5315                  | 5510   | 5705   | 5900                             | 6095                      | 4265   | 4420     | 4575      |    |
| _L CONFIG (012-055-071-042) | 102X102X40         | 7590    | 7915                  | 8240   | 8565   | 8890                             | 9215                      | 6215   | 6440     | 6665      |    |
| _M CONFIG (041-071-055-089) | 102X89X40          | 6710    | 7030                  | 7350   | 7670   | 7990                             | 8310                      | 5495   | 5680     | 5865      |    |



# BUDAPEST

**OPTIMA**  
Collection

**Jaymar**

Conçu et fabriqué fièrement au Canada  
Proudly designed and made in Canada

Nos produits sont fabriqués à la main et  
des variations mineures peuvent survenir

Our product is hand-made and minor variations can occur.

## SPECIFICATIONS

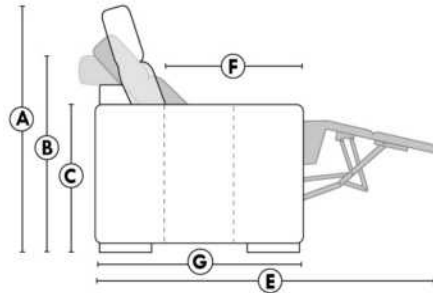

- Appui-tête levé / Headrest up
- Appui-tête baissé / Headrest down
- Complètement incliné / Fully reclined

- A** Hauteur complète 40" / Total Height
- B** Hauteur appui-tête baissé 33" / Height headrest down
- C** Hauteur du bras 24" / Arm Height
- D** Hauteur du siège 19,5" / Seat height
- E** Profondeur inclinée 65" / Depth fully reclined
- F** Profondeur d'assise 20" ou/ou 22" / Seat depth
- G** Profondeur appui-tête monté 37,5" / Depth with headrest up

## BRAS | ARMS

Option de bras:  
Bras Régulier Large 10" ou Petit bras 6"

Arm option  
Regular arm Large 10" or Small arm 6"

Contrôle de l'inclinaison situé à l'intérieur du bras  
Recliner control located on the inside of the arm.

Option d'accessoires disponible sur  
le bras régulier seulement  
Accessories option, available on Regular arms ONLY.

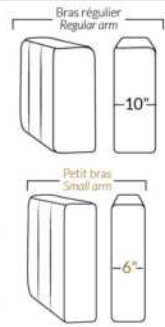

## FAUTEUIL BERÇANT PIVOTANT INCLINABLE SWIVEL ROCKING MOTION CHAIR

Dégagement mural de 16" / Wall clearance  
Hauteur de 42" / Height  
Largeur de bras 6" / Arms width  
Option base de bois / Wood base option

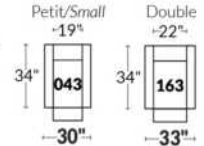

## SIÈGE 23" DE LARGE | 23" SEAT WIDTH

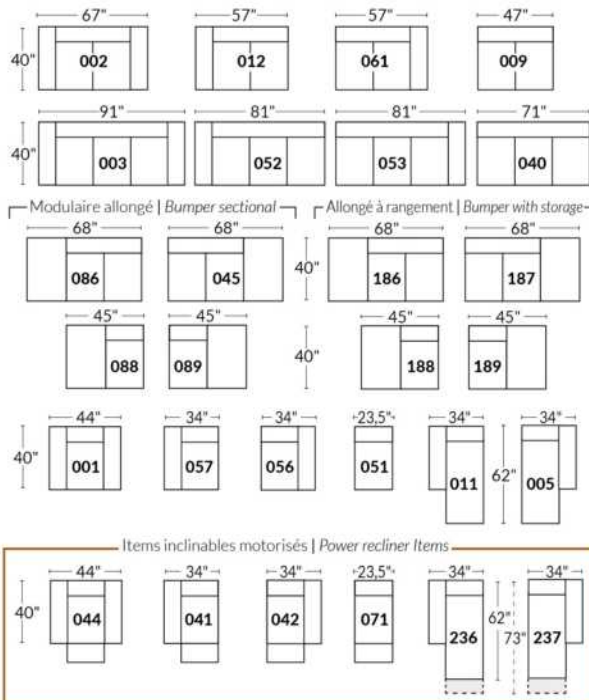

## SIÈGE 30" DE LARGE | 30" SEAT WIDTH

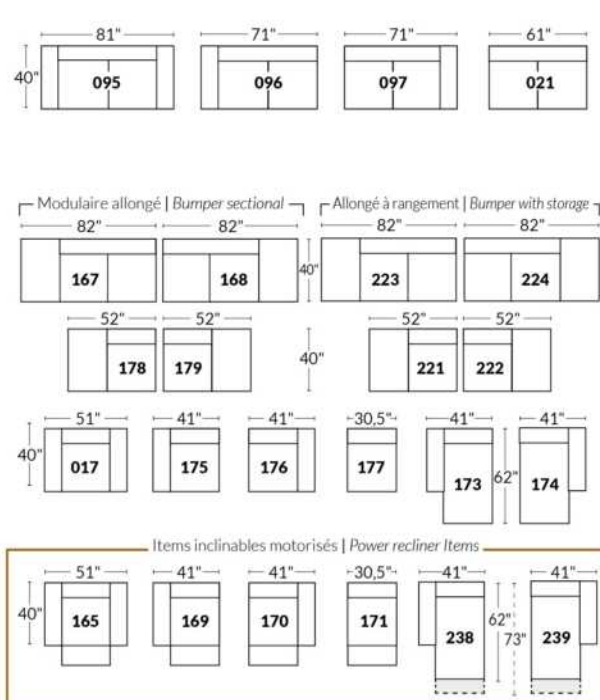

### Autres | Others

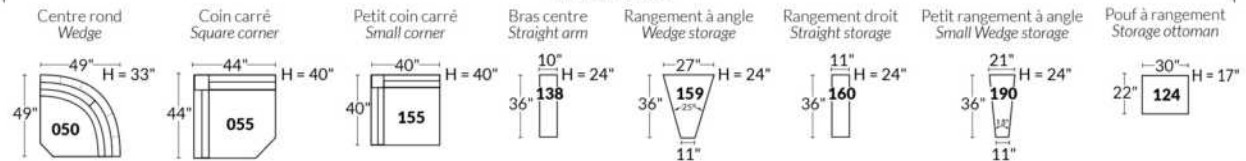

### EXEMPLE 23" EXAMPLE

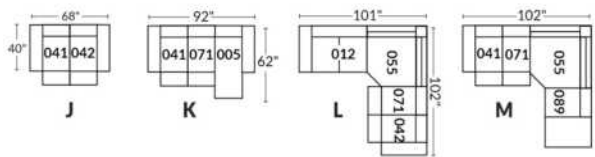

### EXEMPLE 30" EXAMPLE

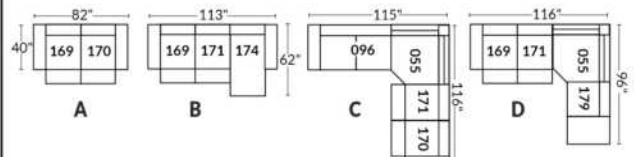

\*Available on certain models and on large arms ONLY.

### OPTIONS CUP HOLDERS

#### METAL



Silver



Matte Black



Brown

#### ILLUMINATED

1.



LED Lighted Cup holder

2.



LED Lighted Cup holder with Single Motor Control, USB Port and LED Base rail

3.



LED Lighted Cup holder with Dual Motor Control, USB Port and LED Base rail

Our illuminated one or two-control cup holders are compatible with LED lights under the seat. You can control the light on the cup holder. The 2 motor cup holder has a reset (home) button control to close your recliner back to its starting position.

#### LED Light under seat (Optional)

Available only in configurations with a minimum of 1 illuminated motorized cup holder with control buttons. The "light" button will control the opening and closing of the light.

For cup holder prices see description section of the Optima model price list.

Please provide us with a drawing of your configuration which indicates the cup holder type and its positioning.

#### Cup holder with controller:

It is important to specify the placement of the cups; on left arm or right arm and which recliner they will control. If you have a row of several seats with cup holders, by default, the controls will be on the left arms and on the right arm for the last outer chair.

#### EXAMPLE A:

041-169: Controller and cup holder on the left arm

071-171: hidden touch sensor buttons on side of seat

042-170: Controller and cup holder on right arm



#### EXAMPLE B:

071-171: These two items can be connected to a smart cup holder which will control the recliner. You must then use one of these items: 138, 159, 160 and 190



#### Informations about headrest, controller on reclining seat

#### WITH illuminated cup holder

If you have a **stationary item**, you will have cup holder N°1.

If you have a recliner chair with a **manual headrest**, you will have the cup holder N°2.

If you have a recliner chair with an **electric headrest**, you will have cup holder N°3.

#### Without cup holder and with a reclining seat

If you have a recliner with a **manual headrest** you will have the touch sensor button control on the side of the seat.

If you have a recliner with an **electric headrest** you will have a dual push button controller with USB port on the arm.

If you have an **armless recliner**, you will have the hidden touch sensor button control.



Hidden touch sensor



Dual push button

# OPTIMA

## HOME THEATRE Configurations

\*Available on certain models and on large arms ONLY.

OPTIONS

### ACCESSORIES

Accessory Dock



V51 Wine Glass Holder



V52 Plastic Swivel Tray Table



V53 Wood Swivel tray Table  
(Choice of 8 colors)



Specify on which arm (left or right) the tray table will be installed.

V54 Tablet Holder



V55 LED Lamp



(For Accessory Dock price, see description section of the Optima model price list and for Accessory item prices, see at very end of the price list)

#### Items 138-159-160-190 and large arm.

Accessory docks and cups are Optional. \*Not available on small arms\*

Please specify on which arms you want the accessory docks and cup holders.

NB: Item 138-159-160-190 are unfinished on the sides, must be used between 2 seats.

Each storage item has 2 USB ports and one electrical outlet inside the storage.



#### SUGGESTED CONFIGURATIONS

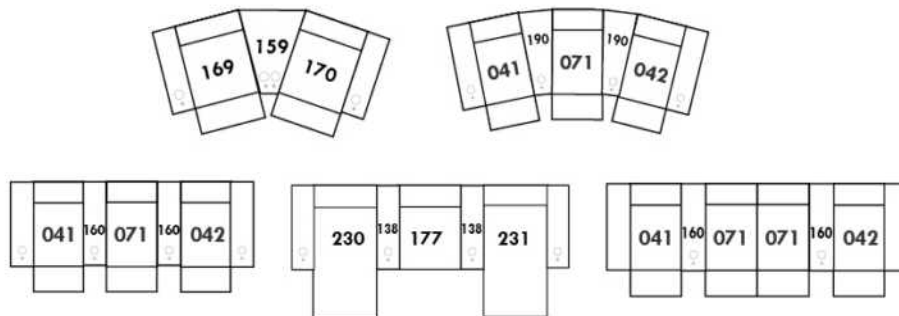

## CDN Price List

### CAVALIA

FEATURES: Memory foam in seat cushions. Stitching: Double & French. In FABRIC there is no vertical stitching on back cushions.

LEG: Specify color of legs LG109. / COMBO: Cover #2 on back, seat & arm pad.

PLAIN FABRIC recommended for the base.

\*REMARK: In leather & fabric, armless end pieces and wedge are NOT fully upholstered.

| Description                         | L x D x H    | Leather |                       |  |  |                                  |                           | Fabric |          |           |
|-------------------------------------|--------------|---------|-----------------------|--|--|----------------------------------|---------------------------|--------|----------|-----------|
|                                     |              | 10      | 20<br>Madras<br>Softy | 30<br>Hugo<br>Fantasy<br>Illusion<br>Tucson<br>Utah<br>Vintage<br>Wild Laredo<br>Yukon | 40<br>Elegance<br>Princess<br>Santiago<br>Sensation<br>Sunset<br>Trina<br>Victoria | 50<br>Bull<br>Cassiope<br>Dublin | 60<br>Caress<br>Ultrasued | A      | B<br>COM | C<br>alta |
| 001 CHAIR                           | 46X37X34     | 1415    | 1505                  | 1595   | 1685   | 1775                             | 1865                      | 1040   | 1100     | 1160      |
| 002 LOVESEAT                        | 69X37X34     | 2040    | 2155                  | 2270   | 2385   | 2500                             | 2615                      | 1360   | 1435     | 1510      |
| 005 LOUNGE CHAIR RIGHT ARM          | 43X62X34     | 1370    | 1475                  | 1580   | 1685   | 1790                             | 1895                      | 975    | 1035     | 1095      |
| 006 OTTOMAN                         | 25.5X25.5X18 | 690     | 715                   | 740  | 765  | 790                              | 815                       | 505    | 525      | 545       |
| 011 LOUNGE CHAIR LEFT ARM           | 43X62X34     | 1370    | 1475                  | 1580   | 1685   | 1790                             | 1895                      | 975    | 1035     | 1095      |
| 012 LOVESEAT LEFT ARM               | 57X37X34     | 1750    | 1860                  | 1970   | 2080   | 2190                             | 2300                      | 1255   | 1330     | 1405      |
| 024 SECTIONAL LOVESEAT BUMPER RIGHT | 90X37X34     | 2340    | 2520                  | 2700   | 2880   | 3060                             | 3240                      | 1740   | 1850     | 1960      |
| 048 SECTIONAL LOVESEAT BUMPER LEFT  | 90X37X34     | 2340    | 2520                  | 2700   | 2880   | 3060                             | 3240                      | 1740   | 1850     | 1960      |
| 050 WEDGE                           | 47X47X34     | 1210    | 1305                  | 1400   | 1495   | 1590                             | 1685                      | 955    | 1015     | 1075      |
| 055 SQUARE CORNER                   | 37X37X34     | 1160    | 1270                  | 1380   | 1490   | 1600                             | 1710                      | 910    | 970      | 1030      |
| 056 CHAIR RIGHT ARM                 | 43X37X34     | 1130    | 1225                  | 1320   | 1415   | 1510                             | 1605                      | 950    | 1005     | 1060      |
| 057 CHAIR LEFT ARM                  | 43X37X34     | 1130    | 1225                  | 1320   | 1415   | 1510                             | 1605                      | 950    | 1005     | 1060      |
| 061 LOVESEAT RIGHT ARM              | 57X37X34     | 1750    | 1860                  | 1970   | 2080   | 2190                             | 2300                      | 1255   | 1330     | 1405      |
| 088 ARMLESS CHAIR BUMPER LEFT       | 53X37X34     | 1285    | 1365                  | 1445   | 1525   | 1605                             | 1685                      | 950    | 1005     | 1060      |
| 089 ARMLESS CHAIR BUMPER RIGHT      | 53X37X34     | 1285    | 1365                  | 1445   | 1525   | 1605                             | 1685                      | 950    | 1005     | 1060      |
| 095 APARTMENT SOFA                  | 87X37X34     | 2290    | 2435                  | 2580   | 2725   | 2870                             | 3015                      | 1575   | 1655     | 1735      |
| 096 APARTMENT SOFA LEFT ARM         | 75X37X34     | 1990    | 2145                  | 2300   | 2455   | 2610                             | 2765                      | 1480   | 1570     | 1660      |
| 097 APARTMENT SOFA RIGHT ARM        | 75X37X34     | 1990    | 2145                  | 2300   | 2455   | 2610                             | 2765                      | 1480   | 1570     | 1660      |
| <b>CONFIGURATIONS</b>               |              |         |                       |  |  |                                  |                           |        |          |           |
| A CONF. A (12-50-61)                | 104X104X34   | 4710    | 5025                  | 5340   | 5655   | 5970                             | 6285                      | 3465   | 3675     | 3885      |
| B CONF. B (12-50-89)                | 100X104X34   | 4245    | 4530                  | 4815   | 5100   | 5385                             | 5670                      | 3160   | 3350     | 3540      |
| C CONF. C (88-50-89)                | 100X100X34   | 3780    | 4035                  | 4290   | 4545   | 4800                             | 5055                      | 2855   | 3025     | 3195      |
| D CONF. D (96-50-56)                | 90X122X34    | 4330    | 4675                  | 5020   | 5365   | 5710                             | 6055                      | 3385   | 3590     | 3795      |
| E CONF. E (95-01-06)                | 87X37X34     | 4395    | 4655                  | 4915   | 5175   | 5435                             | 5695                      | 3120   | 3280     | 3440      |
| F CONF. F (12-50-97)                | 122X104X34   | 4950    | 5310                  | 5670   | 6030   | 6390                             | 6750                      | 3690   | 3915     | 4140      |
| G CONF. G (96-05)                   | 118X62X34    | 3360    | 3620                  | 3880   | 4140   | 4400                             | 4660                      | 2455   | 2605     | 2755      |



Hauteur complète 34" | Hauteur de siège 18" | Hauteur devant bras 24" | Profondeur d'assise 21"  
 Total Height 34" | Seat Height 18" | Arm Height 24" | Seat Depth 21"

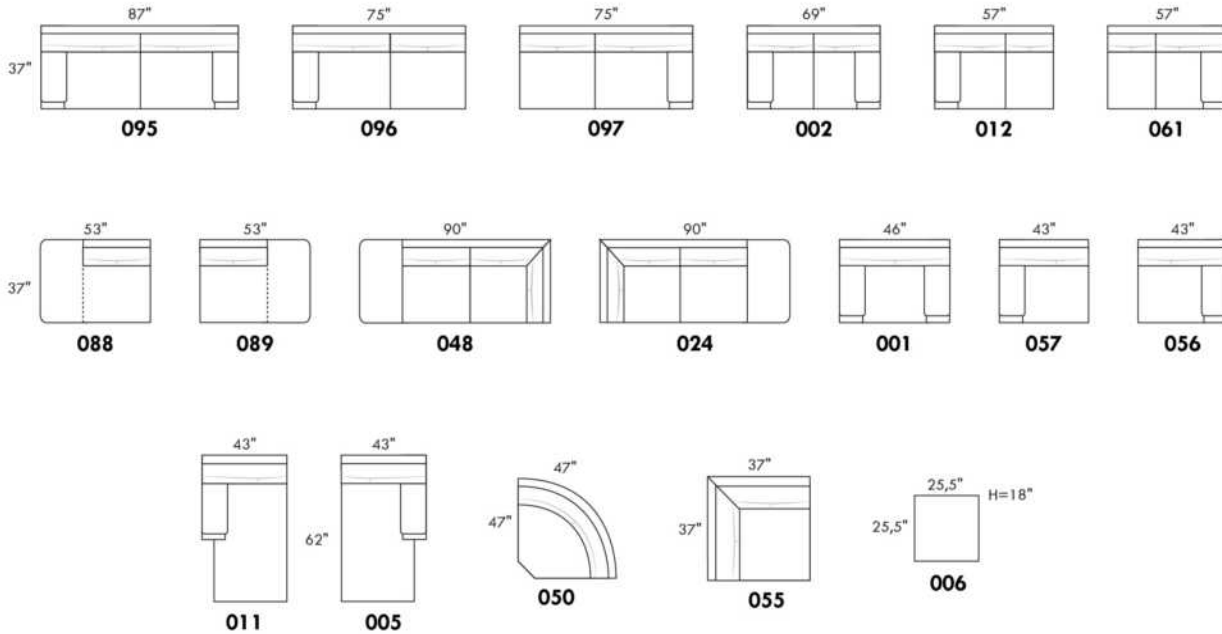

## CONFIGURATIONS

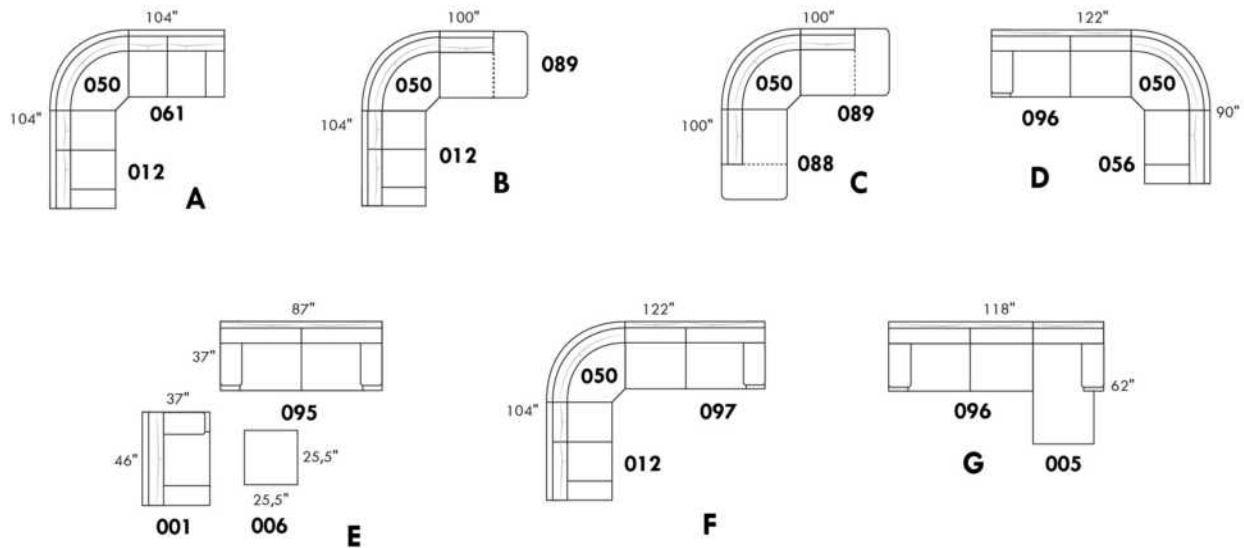

www.jaymar.ca

Toutes les dimensions indiquées sont au pouce près. Nos produits sont fabriqués à la main et des variations mineures peuvent survenir.  
 All dimensions indicated are to the nearest inch. Our product is hand-made and minor variations can occur.

## CHAMONIX

### FEATURES:

- Manual adjustable headrest on all items (stationary on wedge).
- \*Wall hugger power recliners with full footrest (manual n/a).
- Power recliner lounge chair (manual n/a) with power headrest in option. Wall clearance 8" & front 5".
- Seat cushions with shaped foam + 1" layer of memory foam on top; arm with memory foam.
- Stitching: Small thread in fabric & large flat thread in leather.
- \*Excludes 043 & 163 chairs: Wall clearance 16"

Note: 2 recliner seats separated by a corner can not be opened at the same time. No recliner seats beside item #155 .

### OPTIONS

- Battery Pack: Add \$160/ea.
- \*Motorized headrest: Add \$160 ea. (\*N/A on stationary items).
- Foam: Extra firm add \$15/seat.
- Choice of Large or Small 6" Arm: Leg on LARGE arm: LG187 wood or Metal: LG189 cyl. (Black or Chrome) or LG64 (sq). SMALL Arm: LG08 wood or Metal: LG196 cyl. (Black or Chrome) or LG64 (sq). Specify colour.
- Seat Depth: 20" or \*22". \*22" seat depth N/A on chairs 043 & 163.
- 043 & 163 Chairs: with wood base (specify colour).

### HOME THEATRE Configurations

For Accessories, Cup holders & Configuration details, see Optima Home Theatre page attached.

Accessory Dock : \$35 ea.

Cup Holders: Metal: \$25 ea. | LED lighted Cup Holder: \$25 ea. | \*LED lighted Cup Holder with (1 or 2 motor) controls: \$40 ea.

\*LED Light strip under seat: \$25/seat.

| Description                        | L x D x H   | Leather |                       |  |  |                                  |                           | Fabric |          |           |
|------------------------------------|-------------|---------|-----------------------|--|--|----------------------------------|---------------------------|--------|----------|-----------|
|                                    |             | 10      | 20<br>Madras<br>Softy | 30<br>Hugo<br>Fantasy<br>Illusion<br>Tucson<br>Utah<br>Vintage<br>Wild Laredo<br>Yukon | 40<br>Elegance<br>Princess<br>Santiago<br>Sensation<br>Sunset<br>Trina<br>Victoria | 50<br>Bull<br>Cassiope<br>Dublin | 60<br>Caress<br>Ultrasued | A      | B<br>COM | C<br>alta |
| 001 CHAIR                          | 42x40x33/40 | 1890    | 1980                  | 2070   | 2160   | 2250                             | 2340                      | 1535   | 1580     | 1625      |
| 002 LOVESEAT                       | 65x40x33/40 | 2700    | 2815                  | 2930   | 3045   | 3160                             | 3275                      | 2175   | 2250     | 2325      |
| 003 SOFA                           | 89x40x33/40 | 3265    | 3415                  | 3565   | 3715   | 3865                             | 4015                      | 2625   | 2715     | 2805      |
| 005 LOUNGE CHAIR RIGHT ARM         | 33x62x33/40 | 1765    | 1830                  | 1895   | 1960   | 2025                             | 2090                      | 1410   | 1470     | 1530      |
| 009 ARMLESS LOVESEAT               | 47x40x33/40 | 1895    | 1965                  | 2035   | 2105   | 2175                             | 2245                      | 1490   | 1570     | 1650      |
| 011 LOUNGE CHAIR LEFT ARM          | 33x62x33/40 | 1765    | 1830                  | 1895   | 1960   | 2025                             | 2090                      | 1410   | 1470     | 1530      |
| 012 LOVESEAT LEFT ARM              | 56x40x33/40 | 2320    | 2420                  | 2520   | 2620   | 2720                             | 2820                      | 1850   | 1925     | 2000      |
| 017 DOUBLE CHAIR                   | 49x40x33/40 | 1980    | 2080                  | 2180   | 2280   | 2380                             | 2480                      | 1600   | 1660     | 1720      |
| 021 APARTMENT SOFA NO ARM          | 61x40x33/40 | 2140    | 2240                  | 2340   | 2440   | 2540                             | 2640                      | 1670   | 1755     | 1840      |
| 040 ARMLESS SOFA                   | 71x40x33/40 | 2450    | 2565                  | 2680   | 2795   | 2910                             | 3025                      | 1950   | 2040     | 2130      |
| 041 RECLINING CHAIR LEFT ARM       | 33x40x33/40 | 1885    | 1960                  | 2035   | 2110   | 2185                             | 2260                      | 1605   | 1640     | 1675      |
| 042 RECLINING CHAIR RIGHT ARM      | 33x40x33/40 | 1885    | 1960                  | 2035   | 2110   | 2185                             | 2260                      | 1605   | 1640     | 1675      |
| 043 SWIVEL ROCKING RECLINING CHAIR | 30x34x42    | 2235    | 2345                  | 2455   | 2565   | 2675                             | 2785                      | 1875   | 1920     | 1965      |
| 044 RECLINER CHAIR                 | 42x40x33/40 | 2275    | 2365                  | 2455   | 2545   | 2635                             | 2725                      | 1920   | 1970     | 2020      |
| 045 ARMLESS LOVESEAT BUMPER RIGHT  | 68x40x33/40 | 2245    | 2340                  | 2435   | 2530   | 2625                             | 2720                      | 1785   | 1850     | 1915      |
| 050 WEDGE                          | 49x49x33    | 1645    | 1745                  | 1845   | 1945   | 2045                             | 2145                      | 1210   | 1270     | 1330      |

## CHAMONIX

### FEATURES:

- Manual adjustable headrest on all items (stationary on wedge).
- \*Wall hugger power recliners with full footrest (manual n/a).
- Power recliner lounge chair (manual n/a) with power headrest in option. Wall clearance 8" & front 5".
- Seat cushions with shaped foam + 1" layer of memory foam on top; arm with memory foam.
- Stitching: Small thread in fabric & large flat thread in leather.
- \*Excludes 043 & 163 chairs: Wall clearance 16"

Note: 2 recliner seats separated by a corner can not be opened at the same time. No recliner seats beside item #155 .

### OPTIONS

- Battery Pack: Add \$160/ea.
- \*Motorized headrest: Add \$160 ea. (\*N/A on stationary items).
- Foam: Extra firm add \$15/seat.
- Choice of Large or Small 6" Arm: Leg on LARGE arm: LG187 wood or Metal: LG189 cyl. (Black or Chrome) or LG64 (sq). SMALL Arm: LG08 wood or Metal: LG196 cyl. (Black or Chrome) or LG64 (sq). Specify colour.
- Seat Depth: 20" or \*22". \*22" seat depth N/A on chairs 043 & 163.
- 043 & 163 Chairs: with wood base (specify colour).

### HOME THEATRE Configurations

For Accessories, Cup holders & Configuration details, see Optima Home Theatre page attached.

Accessory Dock : \$35 ea.

Cup Holders: Metal: \$25 ea. | LED lighted Cup Holder: \$25 ea. | \*LED lighted Cup Holder with (1 or 2 motor) controls: \$40 ea.

\*LED Light strip under seat: \$25/seat.

| Description                      | L x D x H     | Leather |                       |  |  |                                  |                            | Fabric |          |           |
|----------------------------------|---------------|---------|-----------------------|--|--|----------------------------------|----------------------------|--------|----------|-----------|
|                                  |               | 10      | 20<br>Madras<br>Softy | 30<br>Hugo<br>Fantasy<br>Illusion<br>Tucson<br>Utah<br>Vintage<br>Wild Laredo<br>Yukon | 40<br>Elegance<br>Princess<br>Santiago<br>Sensation<br>Sunset<br>Trina<br>Victoria | 50<br>Bull<br>Cassiope<br>Dublin | 60<br>Caresse<br>Ultrasued | A      | B<br>COM | C<br>alta |
| 051 ARMLESS CHAIR                | 23,5x40x33/40 | 1085    | 1135                  | 1185   | 1235   | 1285                             | 1335                       | 845    | 900      | 955       |
| 052 SOFA LEFT ARM                | 80x40x33/40   | 2870    | 3005                  | 3140   | 3275   | 3410                             | 3545                       | 2290   | 2385     | 2480      |
| 053 SOFA RIGHT ARM               | 80x40x33/40   | 2870    | 3005                  | 3140   | 3275   | 3410                             | 3545                       | 2290   | 2385     | 2480      |
| 055 SQUARE CORNER                | 44x44x33/40   | 1915    | 2010                  | 2105   | 2200   | 2295                             | 2390                       | 1510   | 1565     | 1620      |
| 056 CHAIR RIGHT ARM              | 33x40x33/40   | 1510    | 1575                  | 1640   | 1705   | 1770                             | 1835                       | 1200   | 1260     | 1320      |
| 057 CHAIR LEFT ARM               | 33x40x33/40   | 1510    | 1575                  | 1640   | 1705   | 1770                             | 1835                       | 1200   | 1260     | 1320      |
| 061 LOVESEAT RIGHT ARM           | 56x40x33/40   | 2320    | 2420                  | 2520   | 2620   | 2720                             | 2820                       | 1850   | 1925     | 2000      |
| 071 ARMLESS RECLINING CHAIR      | 23,5x40x33/40 | 1470    | 1525                  | 1580   | 1635   | 1690                             | 1745                       | 1250   | 1310     | 1370      |
| 086 ARMLESS LOVESEAT BUMPER LEFT | 68x40x33/40   | 2245    | 2340                  | 2435   | 2530   | 2625                             | 2720                       | 1785   | 1850     | 1915      |
| 088 ARMLESS CHAIR BUMPER LEFT    | 45x40x33/40   | 1440    | 1535                  | 1630   | 1725   | 1820                             | 1915                       | 1130   | 1165     | 1200      |
| 089 ARMLESS CHAIR BUMPER RIGHT   | 45x40x33/40   | 1440    | 1535                  | 1630   | 1725   | 1820                             | 1915                       | 1130   | 1165     | 1200      |
| 095 APARTMENT SOFA               | 79x40x33/40   | 2940    | 3085                  | 3230   | 3375   | 3520                             | 3665                       | 2350   | 2445     | 2540      |
| 096 APARTMENT SOFA LEFT ARM      | 70x40x33/40   | 2570    | 2680                  | 2790   | 2900   | 3010                             | 3120                       | 2020   | 2110     | 2200      |
| 097 APARTMENT SOFA RIGHT ARM     | 70x40x33/40   | 2570    | 2680                  | 2790   | 2900   | 3010                             | 3120                       | 2020   | 2110     | 2200      |
| 124 STORAGE OTTOMAN              | 30x22x17      | 745     | 765                   | 785  | 805  | 825                              | 845                        | 650    | 670      | 690       |
| 138 STRAIGHT ARM                 | 9x36x24       | 415     | 450                   | 485  | 520  | 555                              | 590                        | 350    | 365      | 380       |



## CHAMONIX

### FEATURES:

- Manual adjustable headrest on all items (stationary on wedge).
- \*Wall hugger power recliners with full footrest (manual n/a).
- Power recliner lounge chair (manual n/a) with power headrest in option. Wall clearance 8" & front 5".
- Seat cushions with shaped foam + 1" layer of memory foam on top; arm with memory foam.
- Stitching: Small thread in fabric & large flat thread in leather.
- \*Excludes 043 & 163 chairs: Wall clearance 16"

Note: 2 recliner seats separated by a corner can not be opened at the same time. No recliner seats beside item #155 .

### OPTIONS

- Battery Pack: Add \$160/ea.
- \*Motorized headrest: Add \$160 ea. (\*N/A on stationary items).
- Foam: Extra firm add \$15/seat.
- Choice of Large or Small 6" Arm: Leg on LARGE arm: LG187 wood or Metal: LG189 cyl. (Black or Chrome) or LG64 (sq). SMALL Arm: LG08 wood or Metal: LG196 cyl. (Black or Chrome) or LG64 (sq). Specify colour.
- Seat Depth: 20" or \*22". \*22" seat depth N/A on chairs 043 & 163.
- 043 & 163 Chairs: with wood base (specify colour).

### HOME THEATRE Configurations

For Accessories, Cup holders & Configuration details, see Optima Home Theatre page attached.

Accessory Dock : \$35 ea.

Cup Holders: Metal: \$25 ea. | LED lighted Cup Holder: \$25 ea. | \*LED lighted Cup Holder with (1 or 2 motor) controls: \$40 ea.

\*LED Light strip under seat: \$25/seat.

| Description                            | L x D x H     | Leather |                       |  |  |                                  |                           | Fabric |          |           |
|--|---------------|---------|-----------------------|--|--|----------------------------------|---------------------------|--------|----------|-----------|
|  |               | 10      | 20<br>Madras<br>Softy | 30<br>Hugo<br>Fantasy<br>Illusion<br>Tucson<br>Utah<br>Vintage<br>Wild Laredo<br>Yukon | 40<br>Elegance<br>Princess<br>Santiago<br>Sensation<br>Sunset<br>Trina<br>Victoria | 50<br>Bull<br>Cassiope<br>Dublin | 60<br>Caress<br>Ultrasued | A      | B<br>COM | C<br>alta |
| 155 SMALL SQUARE CORNER                | 40x40x33/40   | 1915    | 2010                  | 2105   | 2200   | 2295                             | 2390                      | 1510   | 1565     | 1620      |
| 159 WEDGE STORAGE                      | 12/27x36x24   | 745     | 775                   | 805  | 835  | 865                              | 895                       | 585    | 600      | 615       |
| 160 STRAIGHT STORAGE                   | 12x36x24      | 720     | 745                   | 770  | 795  | 820                              | 845                       | 550    | 570      | 590       |
| 163 DBL SWIVEL ROCKING RECLINER CHAIR  | 33x34x42      | 2290    | 2410                  | 2530   | 2650   | 2770                             | 2890                      | 1880   | 1930     | 1980      |
| 165 DOUBLE RECLINING CHAIR             | 49x40x33/40   | 2375    | 2475                  | 2575   | 2675   | 2775                             | 2875                      | 2000   | 2065     | 2130      |
| 167 APARTMENT SOFA NO ARM BUMPER LEFT  | 82x40x33/40   | 2490    | 2620                  | 2750   | 2880   | 3010                             | 3140                      | 1960   | 2045     | 2130      |
| 168 APARTMENT SOFA NO ARM BUMPER RIGHT | 82x40x33/40   | 2490    | 2620                  | 2750   | 2880   | 3010                             | 3140                      | 1960   | 2045     | 2130      |
| 169 DOUBLE RECLINING CHAIR LEFT ARM    | 40x40x33/40   | 1990    | 2070                  | 2150   | 2230   | 2310                             | 2390                      | 1670   | 1750     | 1830      |
| 170 DOUBLE RECLINING CHAIR RIGHT ARM   | 40x40x33/40   | 1990    | 2070                  | 2150   | 2230   | 2310                             | 2390                      | 1670   | 1750     | 1830      |
| 171 ARMLESS DOUBLE RECLINING CHAIR     | 30,5x40x33/40 | 1575    | 1625                  | 1675   | 1725   | 1775                             | 1825                      | 1320   | 1380     | 1440      |
| 173 DOUBLE LOUNGE CHAIR LEFT ARM       | 40x62x33/40   | 1915    | 2005                  | 2095   | 2185   | 2275                             | 2365                      | 1535   | 1615     | 1695      |
| 174 DOUBLE LOUNGE CHAIR RIGHT ARM      | 40x62x33/40   | 1915    | 2005                  | 2095   | 2185   | 2275                             | 2365                      | 1535   | 1615     | 1695      |
| 175 DOUBLE CHAIR LEFT ARM              | 40x40x33/40   | 1590    | 1680                  | 1770   | 1860   | 1950                             | 2040                      | 1285   | 1350     | 1415      |
| 176 DOUBLE CHAIR RIGHT ARM             | 40x40x33/40   | 1590    | 1680                  | 1770   | 1860   | 1950                             | 2040                      | 1285   | 1350     | 1415      |
| 177 ARMLESS DOUBLE CHAIR               | 30,5x40x33/40 | 1185    | 1250                  | 1315   | 1380   | 1445                             | 1510                      | 915    | 970      | 1025      |
| 178 ARMLESS DOUBLE CHAIR BUMPER LEFT   | 52x40x33/40   | 1545    | 1625                  | 1705   | 1785   | 1865                             | 1945                      | 1230   | 1290     | 1350      |

## CHAMONIX

### FEATURES:

- Manual adjustable headrest on all items (stationary on wedge).
- \*Wall hugger power recliners with full footrest (manual n/a).
- Power recliner lounge chair (manual n/a) with power headrest in option. Wall clearance 8" & front 5".
- Seat cushions with shaped foam + 1" layer of memory foam on top; arm with memory foam.
- Stitching: Small thread in fabric & large flat thread in leather.
- \*Excludes 043 & 163 chairs: Wall clearance 16"

Note: 2 recliner seats separated by a corner can not be opened at the same time. No recliner seats beside item #155 .

### OPTIONS

- Battery Pack: Add \$160/ea.
- \*Motorized headrest: Add \$160 ea. (\*N/A on stationary items).
- Foam: Extra firm add \$15/seat.
- Choice of Large or Small 6" Arm: Leg on LARGE arm: LG187 wood or Metal: LG189 cyl. (Black or Chrome) or LG64 (sq). SMALL Arm: LG08 wood or Metal: LG196 cyl. (Black or Chrome) or LG64 (sq). Specify colour.
- Seat Depth: 20" or \*22". \*22" seat depth N/A on chairs 043 & 163.
- 043 & 163 Chairs: with wood base (specify colour).

### HOME THEATRE Configurations

For Accessories, Cup holders & Configuration details, see Optima Home Theatre page attached.

Accessory Dock : \$35 ea.

Cup Holders: Metal: \$25 ea. | LED lighted Cup Holder: \$25 ea. | \*LED lighted Cup Holder with (1 or 2 motor) controls: \$40 ea.

\*LED Light strip under seat: \$25/seat.

| Description                            | L x D x H       | Leather |                       |  |  |                                  |                           | Fabric |          |           |
|--|-----------------|---------|-----------------------|--|--|----------------------------------|---------------------------|--------|----------|-----------|
|  |                 | 10      | 20<br>Madras<br>Softy | 30<br>Hugo<br>Fantasy<br>Illusion<br>Tucson<br>Utah<br>Vintage<br>Wild Laredo<br>Yukon | 40<br>Elegance<br>Princess<br>Santiago<br>Sensation<br>Sunset<br>Trina<br>Victoria | 50<br>Bull<br>Cassiope<br>Dublin | 60<br>Caress<br>Ultrasued | A      | B<br>COM | C<br>alta |
| 179 ARMLESS DOUBLE CHAIR BUMPER RIGHT  | 52x40x33/40     | 1545    | 1625                  | 1705   | 1785   | 1865                             | 1945                      | 1230   | 1290     | 1350      |
| 186 ARMLESS LOVESEAT BUMPER STORAGE-L  | 68x40x33/40     | 2420    | 2500                  | 2580   | 2660   | 2740                             | 2820                      | 1950   | 2015     | 2080      |
| 187 ARMLESS LOVESEAT BUMPER STORAGE-R  | 68x40x33/40     | 2420    | 2500                  | 2580   | 2660   | 2740                             | 2820                      | 1950   | 2015     | 2080      |
| 188 ARMLESS CHAIR BUMPER STORAGE-L     | 45x40x33/40     | 1600    | 1690                  | 1780   | 1870   | 1960                             | 2050                      | 1295   | 1330     | 1365      |
| 189 ARMLESS CHAIR BUMPER STORAGE-R     | 45x40x33/40     | 1600    | 1690                  | 1780   | 1870   | 1960                             | 2050                      | 1295   | 1330     | 1365      |
| 190 SMALL WEDGE STORAGE                | 12/21x36x24     | 720     | 745                   | 770  | 795  | 820                              | 845                       | 550    | 570      | 590       |
| 221 ARMLESS DBL CHAIR BUMPER STORAGE-L | 52x40x33/40     | 1705    | 1790                  | 1875   | 1960   | 2045                             | 2130                      | 1390   | 1450     | 1510      |
| 222 ARMLESS DBL CHAIR BUMPER STORAGE-R | 52x40x33/40     | 1705    | 1790                  | 1875   | 1960   | 2045                             | 2130                      | 1390   | 1450     | 1510      |
| 223 APT SOFA NO ARM BUMPER STORAGE-L   | 82x40x33/40     | 2655    | 2785                  | 2915   | 3045   | 3175                             | 3305                      | 2120   | 2215     | 2310      |
| 224 APT SOFA NO ARM BUMPER STORAGE-R   | 82x40x33/40     | 2655    | 2785                  | 2915   | 3045   | 3175                             | 3305                      | 2120   | 2215     | 2310      |
| 236 RECLINING LOUNGE CHAIR LEFT ARM    | 33x62x33/40     | 2160    | 2225                  | 2290   | 2355   | 2420                             | 2485                      | 1820   | 1880     | 1940      |
| 237 RECLINING LOUNGE CHAIR RIGHT ARM   | 33x62x33/40     | 2160    | 2225                  | 2290   | 2355   | 2420                             | 2485                      | 1820   | 1880     | 1940      |
| 238 RECLINING DBL LOUNGE CHAIR L-ARM   | 40x62x33/40     | 2315    | 2405                  | 2495   | 2585   | 2675                             | 2765                      | 1940   | 2020     | 2100      |
| 239 RECLINING DBL LOUNGE CHAIR R-ARM   | 40x62x33/40     | 2315    | 2405                  | 2495   | 2585   | 2675                             | 2765                      | 1940   | 2020     | 2100      |
| V51 WINE GLASS HOLDER                  | 3.5 x 5.5 x 6.6 | 35      | 35                    | 35   | 35   | 35                               | 35                        | 35     | 35       | 35        |
| V52 PLASTIC SWIVEL TRAY                | 13 3/8 x 9 5/8  | 35      | 35                    | 35   | 35   | 35                               | 35                        | 35     | 35       | 35        |

## CHAMONIX

### FEATURES:

- Manual adjustable headrest on all items (stationary on wedge).
- \*Wall hugger power recliners with full footrest (manual n/a).
- Power recliner lounge chair (manual n/a) with power headrest in option. Wall clearance 8" & front 5".
- Seat cushions with shaped foam + 1" layer of memory foam on top; arm with memory foam.
- Stitching: Small thread in fabric & large flat thread in leather.
- \*Excludes 043 & 163 chairs: Wall clearance 16"

Note: 2 recliner seats separated by a corner can not be opened at the same time. No recliner seats beside item #155 .

### OPTIONS

- Battery Pack: Add \$160/ea.
- \*Motorized headrest: Add \$160 ea. (\*N/A on stationary items).
- Foam: Extra firm add \$15/seat.
- Choice of Large or Small 6" Arm: Leg on LARGE arm: LG187 wood or Metal: LG189 cyl. (Black or Chrome) or LG64 (sq). SMALL Arm: LG08 wood or Metal: LG196 cyl. (Black or Chrome) or LG64 (sq). Specify colour.
- Seat Depth: 20" or \*22". \*22" seat depth N/A on chairs 043 & 163.
- 043 & 163 Chairs: with wood base (specify colour).

### HOME THEATRE Configurations

For Accessories, Cup holders & Configuration details, see Optima Home Theatre page attached.

Accessory Dock : \$35 ea.

Cup Holders: Metal: \$25 ea. | LED lighted Cup Holder: \$25 ea. | \*LED lighted Cup Holder with (1 or 2 motor) controls: \$40 ea.

\*LED Light strip under seat: \$25/seat.

| Description                 | L x D x H          | Leather |                       |  |  |                                  |                           | Fabric |          |           |
|-----------------------------|--------------------|---------|-----------------------|--|--|----------------------------------|---------------------------|--------|----------|-----------|
|                             |                    | 10      | 20<br>Madras<br>Softy | 30<br>Hugo<br>Fantasy<br>Illusion<br>Tucson<br>Utah<br>Vintage<br>Wild Laredo<br>Yukon | 40<br>Elegance<br>Princess<br>Santiago<br>Sensation<br>Sunset<br>Trina<br>Victoria | 50<br>Bull<br>Cassiope<br>Dublin | 60<br>Caress<br>Ultrasued | A      | B<br>COM | C<br>alta |
| V53 WOOD SWIVEL TRAY        | 19 x 10            | 60      | 60                    | 60   | 60   | 60                               | 60                        | 60     | 60       | 60        |
| V54 TABLET HOLDER           | 4.5 x 8 x 10       | 40      | 40                    | 40   | 40   | 40                               | 40                        | 40     | 40       | 40        |
| V55 LED LAMP                | 1.5x5x14 plié/bent | 35      | 35                    | 35   | 35   | 35                               | 35                        | 35     | 35       | 35        |
| <b>CONFIGURATIONS</b>       |                    |         |                       |  |  |                                  |                           |        |          |           |
| _A CONFIG (169-170)         | 80X40X40           | 3980    | 4140                  | 4300   | 4460   | 4620                             | 4780                      | 3340   | 3500     | 3660      |
| _B CONFIG (169-171-174)     | 111X62X40          | 5480    | 5700                  | 5920   | 6140   | 6360                             | 6580                      | 4525   | 4745     | 4965      |
| _C CONFIG (096-055-171-170) | 115X115X40         | 8050    | 8385                  | 8720   | 9055   | 9390                             | 9725                      | 6520   | 6805     | 7090      |
| _D CONFIG (169-171-055-179) | 115X96X40          | 7025    | 7330                  | 7635   | 7940   | 8245                             | 8550                      | 5730   | 5985     | 6240      |
| _J CONFIG (041-042)         | 66X40X40           | 3770    | 3920                  | 4070   | 4220   | 4370                             | 4520                      | 3210   | 3280     | 3350      |
| _K CONFIG (041-071-005)     | 90X62X40           | 5120    | 5315                  | 5510   | 5705   | 5900                             | 6095                      | 4265   | 4420     | 4575      |
| _L CONFIG (012-055-071-042) | 101X101X40         | 7590    | 7915                  | 8240   | 8565   | 8890                             | 9215                      | 6215   | 6440     | 6665      |
| _M CONFIG (041-071-055-089) | 101X89X40          | 6710    | 7030                  | 7350   | 7670   | 7990                             | 8310                      | 5495   | 5680     | 5865      |



# CHAMONIX

**OPTIMA**  
Collection

**Jaymar**

Conçu et fabriqué fièrement au Canada  
Proudly designed and made in Canada

Nos produits sont fabriqués à la main et des variations mineures peuvent survenir.

Our product is hand-made and minor variations can occur.

## SPECIFICATIONS

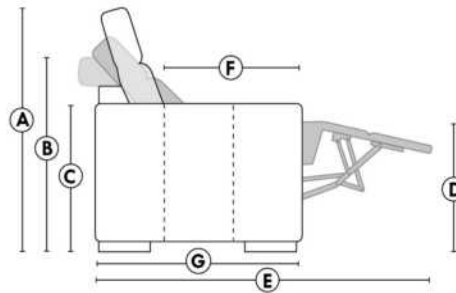

- Appui-tête levé Headrest up
- Appui-tête baissé Headrest down
- Complètement incliné Fully reclined

- A** Hauteur complète 40" Total Height
- B** Hauteur appui-tête baissé 33" Height headrest down
- C** Hauteur du bras 24" Arm Height
- D** Hauteur du siège 19,5" Seat height
- E** Profondeur inclinée 65" Depth fully reclined
- F** Profondeur d'assise 20"ou/ou 22" Seat depth
- G** Profondeur appui-tête monté 37,5" Depth with headrest up

## BRAS | ARMS

Option de bras:  
Bras Régulier Large 9" ou Petit bras 6"

Arm option  
Regular arm Large 9" or Small arm 6"

Contrôle de l'inclinaison situé à l'intérieur du bras  
Recliner control located on the inside of the arm.

Option d'accessoires disponible sur le bras régulier seulement  
Accessories option, available on Regular arms ONLY.

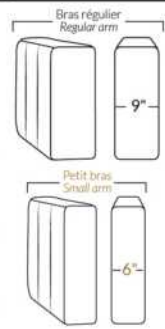

## FAUTEUIL BERÇANT PIVOTANT INCLINABLE SWIVEL ROCKING MOTION CHAIR



## SIÈGE 23" DE LARGE | 23" SEAT WIDTH

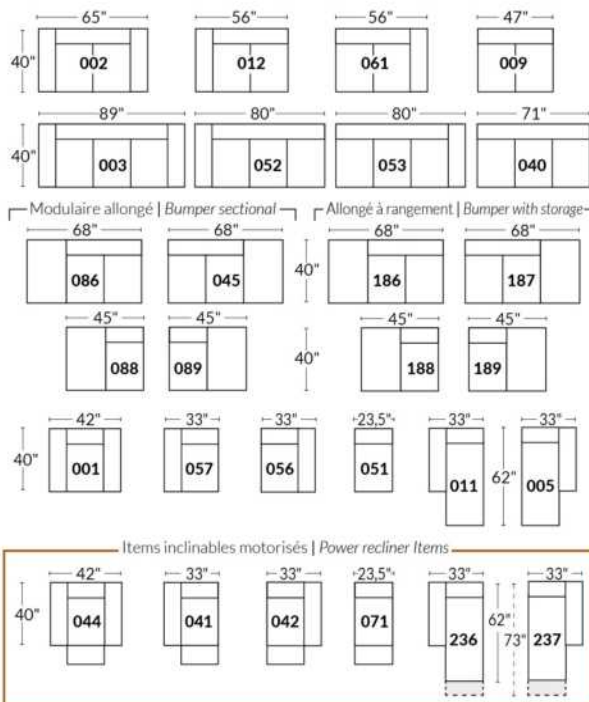

## SIÈGE 30" DE LARGE | 30" SEAT WIDTH

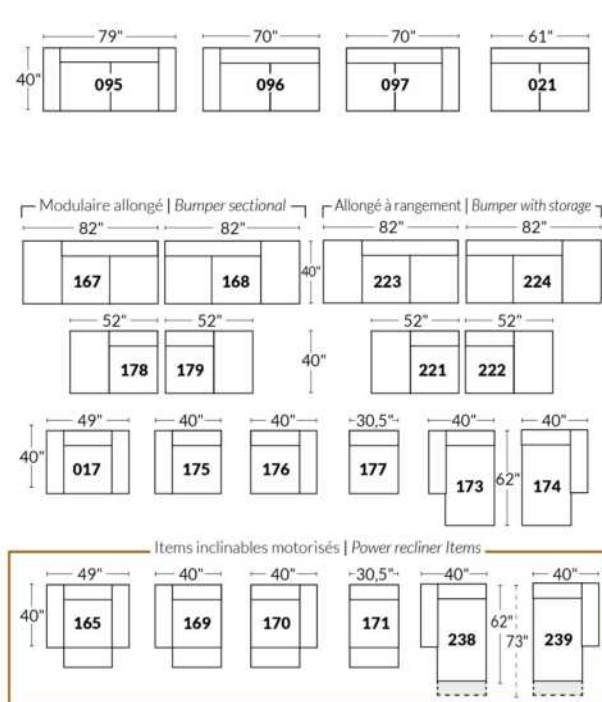

### Autres | Others

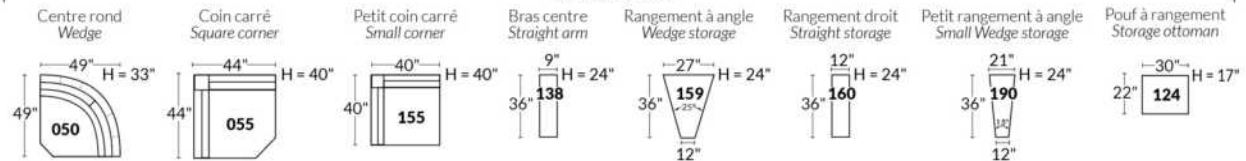

### EXEMPLE 23" EXAMPLE

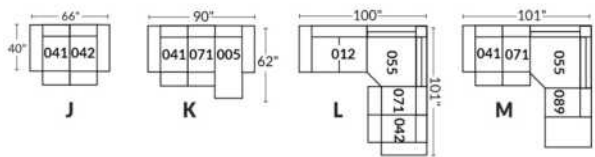

### EXEMPLE 30" EXAMPLE

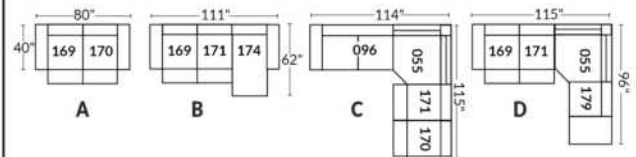

\*Available on certain models and on large arms ONLY.

### OPTIONS CUP HOLDERS

#### METAL



Silver



Matte Black



Brown

#### ILLUMINATED

1.



LED Lighted Cup holder

2.



LED Lighted Cup holder with Single Motor Control, USB Port and LED Base rail

3.



LED Lighted Cup holder with Dual Motor Control, USB Port and LED Base rail

Our illuminated one or two-control cup holders are compatible with LED lights under the seat. You can control the light on the cup holder. The 2 motor cup holder has a reset (home) button control to close your recliner back to its starting position.

#### LED Light under seat (Optional)

Available only in configurations with a minimum of 1 illuminated motorized cup holder with control buttons. The "light" button will control the opening and closing of the light.

For cup holder prices see description section of the Optima model price list.

Please provide us with a drawing of your configuration which indicates the cup holder type and its positioning.

#### Cup holder with controller:

It is important to specify the placement of the cups; on left arm or right arm and which recliner they will control. If you have a row of several seats with cup holders, by default, the controls will be on the left arms and on the right arm for the last outer chair.

#### EXAMPLE A:

041-169: Controller and cup holder on the left arm

071-171: hidden touch sensor buttons on side of seat

042-170: Controller and cup holder on right arm



#### EXAMPLE B:

071-171: These two items can be connected to a smart cup holder which will control the recliner. You must then use one of these items: 138, 159, 160 and 190



#### Informations about headrest, controller on reclining seat

#### WITH illuminated cup holder

If you have a **stationary item**, you will have cup holder N°1.

If you have a recliner chair with a **manual headrest**, you will have the cup holder N°2.

If you have a recliner chair with an **electric headrest**, you will have cup holder N°3.

#### Without cup holder and with a reclining seat

If you have a recliner with a **manual headrest** you will have the touch sensor button control on the side of the seat.

If you have a recliner with an **electric headrest** you will have a dual push button controller with USB port on the arm.

If you have an **armless recliner**, you will have the hidden touch sensor button control.



Hidden touch sensor



Dual push button

# OPTIMA

## HOME THEATRE Configurations

\*Available on certain models and on large arms ONLY.

OPTIONS

### ACCESSORIES

Accessory Dock



V51 Wine Glass Holder



V52 Plastic Swivel Tray Table



V53 Wood Swivel tray Table  
(Choice of 8 colors)



Specify on which arm (left or right) the tray table will be installed.

V54 Tablet Holder



V55 LED Lamp



(For Accessory Dock price, see description section of the Optima model price list and for Accessory item prices, see at very end of the price list)

### Items 138-159-160-190 and large arm.

Accessory docks and cups are Optional. \*Not available on small arms\*

Please specify on which arms you want the accessory docks and cup holders.

NB: Item 138-159-160-190 are unfinished on the sides, must be used between 2 seats.

Each storage item has 2 USB ports and one electrical outlet inside the storage.



### SUGGESTED CONFIGURATIONS





## CDN Price List

### CHLOE

FEATURES: Piping on arm contour , upholsterd seat cushions with shaped foam and 1" layer of memory foam. Back cushions stuffed with fiber filling for ultimate comfort . Deep seating depth of 22".

LEG: Specify color of wood legs LG111.

COMBO: Specify Cover #2 on seats & piping only. If COMBO LEATHER seats: Grade 10 - 30 add \$80 per seat. Grade 40 - 60 add \$120 per seat. Lounge chair or angle chair = 2 seats.

IN FABRIC: There is no stitching on seats for skus 005-011-062 and 063.

PLAIN fabric recommended for the base.

\*REMARK: In leather and fabric, armless end pieces and wedge are not fully upholstered.

| Description                       | L x D x H    | Leather |                       |  |  |                                  |                           | Fabric |          |           |
|-----------------------------------|--------------|---------|-----------------------|--|--|----------------------------------|---------------------------|--------|----------|-----------|
|                                   |              | 10      | 20<br>Madras<br>Softy | 30<br>Hugo<br>Fantasy<br>Illusion<br>Tucson<br>Utah<br>Vintage<br>Wild Laredo<br>Yukon | 40<br>Elegance<br>Princess<br>Santiago<br>Sensation<br>Sunset<br>Trina<br>Victoria | 50<br>Bull<br>Cassiope<br>Dublin | 60<br>Caress<br>Ultrasued | A      | B<br>COM | C<br>alta |
| 001 CHAIR                         | 39 x 38 x 36 | 1485    | 1575                  | 1665   | 1755   | 1845                             | 1935                      | 1040   | 1095     | 1150      |
| 002 LOVESEAT                      | 62 x 38 x 36 | 2120    | 2250                  | 2380   | 2510   | 2640                             | 2770                      | 1365   | 1435     | 1505      |
| 005 LOUNGE CHAIR RIGHT ARM        | 38 x 67 x 36 | 1650    | 1760                  | 1870   | 1980   | 2090                             | 2200                      | 1235   | 1300     | 1365      |
| 006 OTTOMAN                       | 40 x 29 x 17 | 785     | 840                   | 895  | 950  | 1005                             | 1060                      | 675    | 700      | 725       |
| 009 ARMLESS LOVESEAT              | 46 x 38 x 36 | 1575    | 1685                  | 1795   | 1905   | 2015                             | 2125                      | 1140   | 1215     | 1290      |
| 011 LOUNGE CHAIR LEFT ARM         | 38 x 67 x 36 | 1650    | 1760                  | 1870   | 1980   | 2090                             | 2200                      | 1235   | 1300     | 1365      |
| 012 LOVESEAT LEFT ARM             | 54 x 38 x 36 | 1815    | 1935                  | 2055   | 2175   | 2295                             | 2415                      | 1280   | 1335     | 1390      |
| 045 ARMLESS LOVESEAT BUMPER RIGHT | 67 x 38 x 36 | 1815    | 1935                  | 2055   | 2175   | 2295                             | 2415                      | 1235   | 1310     | 1385      |
| 050 WEDGE                         | 50 x 50 x 36 | 1485    | 1580                  | 1675   | 1770   | 1865                             | 1960                      | 1085   | 1130     | 1175      |
| 051 ARMLESS CHAIR                 | 23 x 38 x 36 | 830     | 925                   | 1020   | 1115   | 1210                             | 1305                      | 795    | 855      | 915       |
| 055 SQUARE CORNER                 | 39 x 39 x 36 | 1340    | 1445                  | 1550   | 1655   | 1760                             | 1865                      | 1050   | 1100     | 1150      |
| 056 CHAIR RIGHT ARM               | 31 x 38 x 36 | 1135    | 1245                  | 1355   | 1465   | 1575                             | 1685                      | 910    | 965      | 1020      |
| 057 CHAIR LEFT ARM                | 31 x 38 x 36 | 1135    | 1245                  | 1355   | 1465   | 1575                             | 1685                      | 910    | 965      | 1020      |
| 061 LOVESEAT RIGHT ARM            | 54 x 38 x 36 | 1815    | 1935                  | 2055   | 2175   | 2295                             | 2415                      | 1280   | 1335     | 1390      |
| 062 ANGLE CHAIR LEFT ARM          | 65 x 68 x 36 | 2055    | 2160                  | 2265   | 2370   | 2475                             | 2580                      | 1605   | 1665     | 1725      |
| 063 ANGLE CHAIR RIGHT ARM         | 65 x 68 x 36 | 2055    | 2160                  | 2265   | 2370   | 2475                             | 2580                      | 1605   | 1665     | 1725      |
| 086 ARMLESS LOVESEAT BUMPER LEFT  | 67 X 38 X 36 | 1815    | 1935                  | 2055   | 2175   | 2295                             | 2415                      | 1235   | 1310     | 1385      |
| 095 APARTMENT SOFA                | 76 x 38 x 36 | 2305    | 2445                  | 2585   | 2725   | 2865                             | 3005                      | 1570   | 1650     | 1730      |
| 096 APARTMENT SOFA LEFT ARM       | 68 x 38 x 36 | 2015    | 2160                  | 2305   | 2450   | 2595                             | 2740                      | 1445   | 1530     | 1615      |
| 097 APARTMENT SOFA RIGHT ARM      | 68 x 38 x 36 | 2015    | 2160                  | 2305   | 2450   | 2595                             | 2740                      | 1445   | 1530     | 1615      |
| <b>CONFIGURATIONS</b>             |              |         |                       |  |  |                                  |                           |        |          |           |
| A CONF. A (096-005)               | 106X67X36    | 3665    | 3920                  | 4175   | 4430   | 4685                             | 4940                      | 2680   | 2830     | 2980      |

## CDN Price List

### CHLOE

| Description             | L x D x H  | Leather |                       |  |  |                                  |                           | Fabric |          |           |
|-------------------------|------------|---------|-----------------------|--|--|----------------------------------|---------------------------|--------|----------|-----------|
|                         |            | 10      | 20<br>Madras<br>Softy | 30<br>Hugo<br>Fantasy<br>Illusion<br>Tucson<br>Utah<br>Vintage<br>Wild Laredo<br>Yukon | 40<br>Elegance<br>Princess<br>Santiago<br>Sensation<br>Sunset<br>Trina<br>Victoria | 50<br>Bull<br>Cassiope<br>Dublin | 60<br>Caress<br>Ultrasued | A      | B<br>COM | C<br>alta |
| B CONF. B (096-063)     | 136X68X36  | 4070    | 4320                  | 4570   | 4820   | 5070                             | 5320                      | 3050   | 3195     | 3340      |
| C CONF. C (011-061)     | 92X67X36   | 3465    | 3695                  | 3925   | 4155   | 4385                             | 4615                      | 2515   | 2635     | 2755      |
| D CONF. D (086-005)     | 105X67X36  | 3465    | 3695                  | 3925   | 4155   | 4385                             | 4615                      | 2470   | 2610     | 2750      |
| E CONF. E (062-061)     | 122X68X36  | 3870    | 4095                  | 4320   | 4545   | 4770                             | 4995                      | 2885   | 3000     | 3115      |
| F CONF. F (086-063)     | 135X68X36  | 3870    | 4095                  | 4320   | 4545   | 4770                             | 4995                      | 2840   | 2975     | 3110      |
| G CONF. G (012-050-061) | 104X104X36 | 5115    | 5450                  | 5785   | 6120   | 6455                             | 6790                      | 3645   | 3800     | 3955      |
| H CONF. H (012-055-045) | 106X93X36  | 4970    | 5315                  | 5660   | 6005   | 6350                             | 6695                      | 3565   | 3745     | 3925      |
| I CONF. I (096-050-045) | 118X117X36 | 5315    | 5675                  | 6035   | 6395   | 6755                             | 7115                      | 3765   | 3970     | 4175      |
| J CONF. J (096-055-061) | 107X93X36  | 5170    | 5540                  | 5910   | 6280   | 6650                             | 7020                      | 3775   | 3965     | 4155      |
| K CONF. K (086-050-045) | 117X117X36 | 5115    | 5450                  | 5785   | 6120   | 6455                             | 6790                      | 3555   | 3750     | 3945      |



Hauteur complète 36" | Hauteur de siège 18" | Hauteur devant bras 24" | Profondeur d'assise 22"  
Total Height 36" | Seat Height 18" | Arm Height 24" | Seat Depth 22"

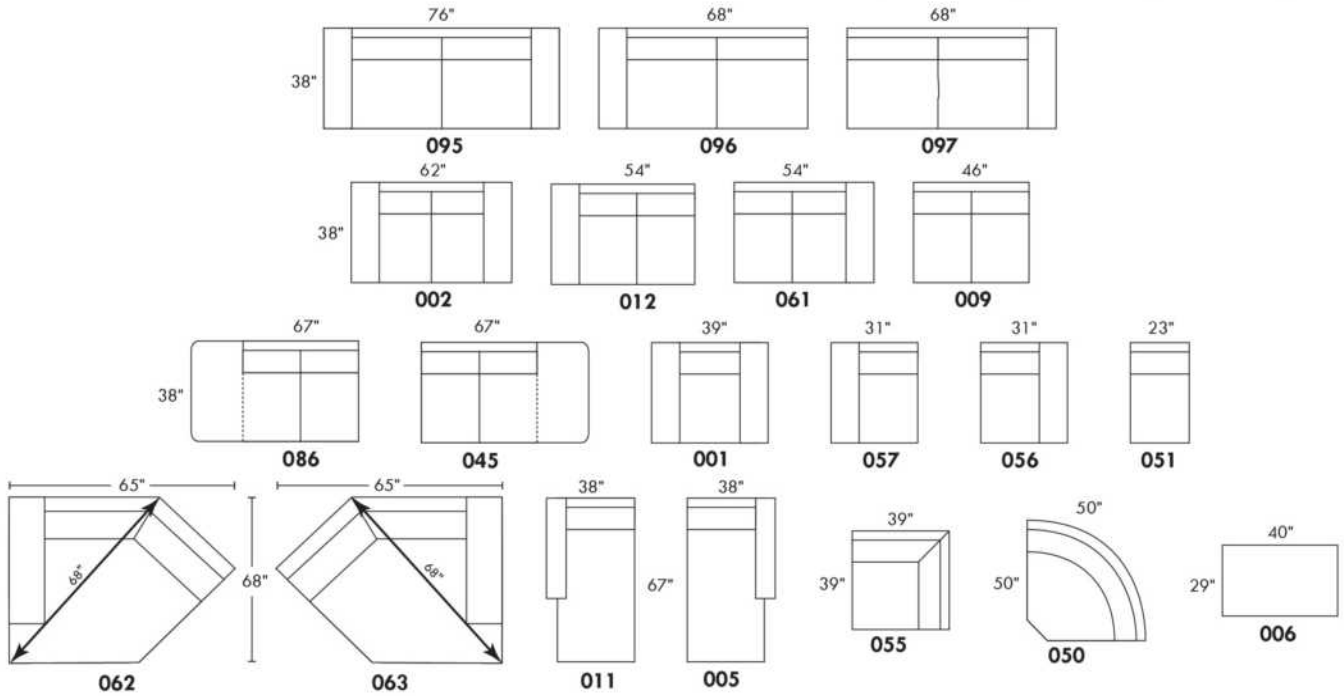

## CONFIGURATIONS

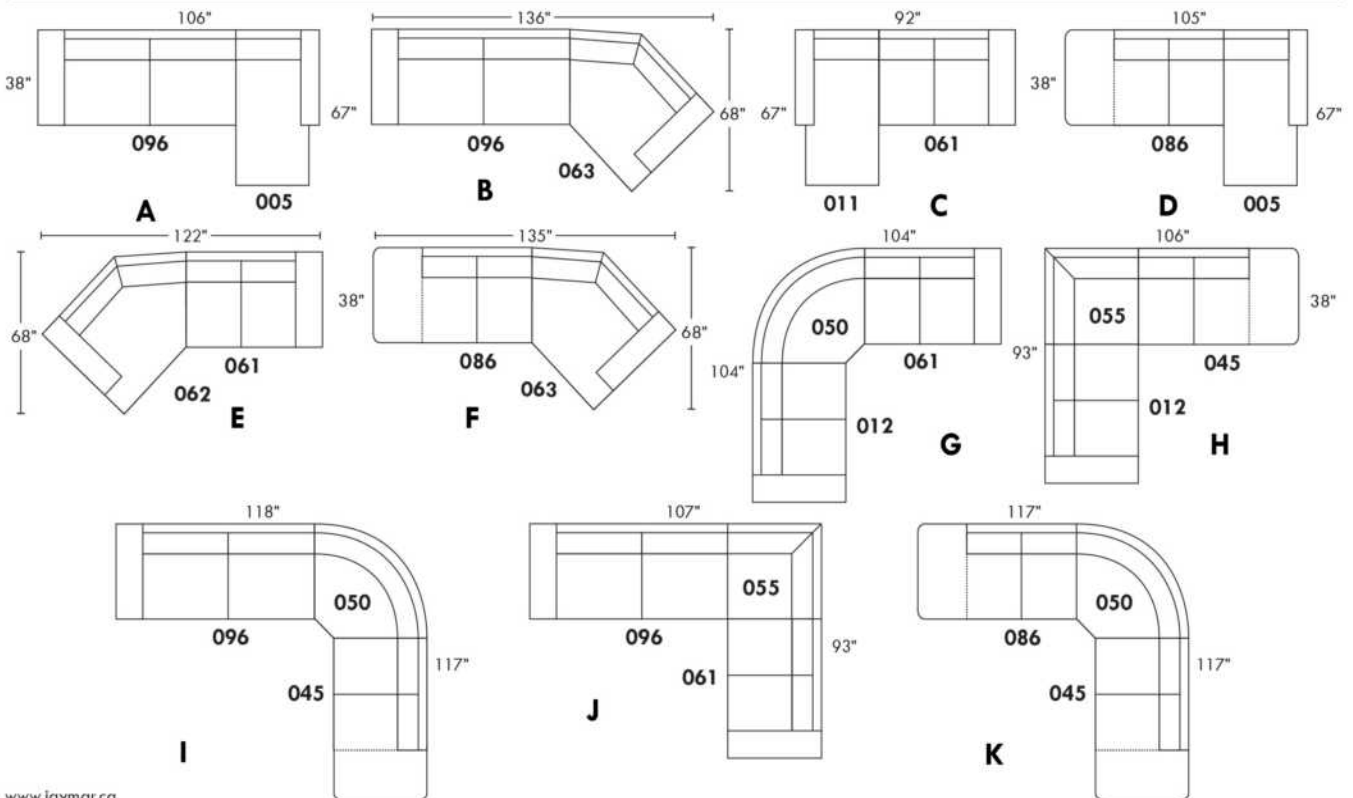

www.jaymar.ca

Toutes les dimensions indiquées sont au pouce près. Nos produits sont fabriqués à la main et des variations mineures peuvent survenir.  
All dimensions indicated are to the nearest inch. Our product is hand-made and minor variations can occur.



## CORRADO

Features: Manual adjustable headrest included (2 on square corner). Stitching: Small thread in fabric & large flat thread in leather. Memory foam in seat cushions.

NOTE: 2 recliner seats SEPARATED by a SQUARE CORNER or TABLE cannot be opened at the same time.

OPTIONS - Specify on your order + SKETCH of your config.:

Leg: LG64 metal or LG08 wood (specify colour).

TABLE #154: Specify colour of wood table top.

043 & 163 Chairs: with wood base (specify colour).

Accessories: Anchorage \$35 ea. | Plastic Swivel tray & Wine Glass holder \$35 ea. | Wood Swivel tray \$60 ea. | Tablet holder \$40 ea. & LED Lamp \$35 ea.

**\*\*MANUAL RECLINER N/A.\*\*** Motorized mechanism included in price of recliner chair items. For Battery Pack add \$160/mechanism.

| Description                        | L x D x H     | Leather |                       |  |  |                                  |                           | Fabric |          |           |
|------------------------------------|---------------|---------|-----------------------|--|--|----------------------------------|---------------------------|--------|----------|-----------|
|                                    |               | 10      | 20<br>Madras<br>Softy | 30<br>Hugo<br>Fantasy<br>Illusion<br>Tucson<br>Utah<br>Vintage<br>Wild Laredo<br>Yukon | 40<br>Elegance<br>Princess<br>Santiago<br>Sensation<br>Sunset<br>Trina<br>Victoria | 50<br>Bull<br>Cassiope<br>Dublin | 60<br>Caress<br>Ultrasued | A      | B<br>COM | C<br>alta |
| 001 CHAIR                          | 38X40X30/39   | 1695    | 1785                  | 1875   | 1965   | 2055                             | 2145                      | 1285   | 1320     | 1355      |
| 002 LOVESEAT                       | 61X40X30/39   | 2495    | 2615                  | 2735   | 2855   | 2975                             | 3095                      | 1875   | 1955     | 2035      |
| 003 SOFA                           | 85X40X30/39   | 3060    | 3210                  | 3360   | 3510   | 3660                             | 3810                      | 2320   | 2395     | 2470      |
| 005 LOUNGE CHAIR RIGHT ARM         | 31X62X30/39   | 1600    | 1680                  | 1760   | 1840   | 1920                             | 2000                      | 1200   | 1280     | 1360      |
| 009 ARMLESS LOVESEAT               | 47X40X30/39   | 1865    | 1940                  | 2015   | 2090   | 2165                             | 2240                      | 1410   | 1485     | 1560      |
| 011 LOUNGE CHAIR LEFT ARM          | 31X62X30/39   | 1600    | 1680                  | 1760   | 1840   | 1920                             | 2000                      | 1200   | 1280     | 1360      |
| 012 LOVESEAT LEFT ARM              | 54X40X30/39   | 2180    | 2290                  | 2400   | 2510   | 2620                             | 2730                      | 1635   | 1715     | 1795      |
| 017 DOUBLE CHAIR                   | 45X40X30/39   | 1795    | 1905                  | 2015   | 2125   | 2235                             | 2345                      | 1335   | 1390     | 1445      |
| 021 APARTMENT SOFA NO ARM          | 61X40X30/39   | 2095    | 2190                  | 2285   | 2380   | 2475                             | 2570                      | 1605   | 1675     | 1745      |
| 040 ARMLESS SOFA                   | 71X40X30/39   | 2435    | 2525                  | 2615   | 2705   | 2795                             | 2885                      | 1830   | 1935     | 2040      |
| 041 RECLINING CHAIR LEFT ARM       | 31X40X30/39   | 1745    | 1815                  | 1885   | 1955   | 2025                             | 2095                      | 1400   | 1465     | 1530      |
| 042 RECLINING CHAIR RIGHT ARM      | 31X40X30/39   | 1745    | 1815                  | 1885   | 1955   | 2025                             | 2095                      | 1400   | 1465     | 1530      |
| 043 SWIVEL ROCKING RECLINING CHAIR | 30 x 34 x 42  | 2150    | 2245                  | 2340   | 2435   | 2530                             | 2625                      | 1790   | 1835     | 1880      |
| 044 RECLINER CHAIR                 | 38X40X30/39   | 2060    | 2155                  | 2250   | 2345   | 2440                             | 2535                      | 1640   | 1690     | 1740      |
| 045 ARMLESS LOVESEAT BUMPER RIGHT  | 68X40X30/39   | 2185    | 2300                  | 2415   | 2530   | 2645                             | 2760                      | 1655   | 1730     | 1805      |
| 051 ARMLESS CHAIR                  | 23,5X40X30/39 | 1060    | 1110                  | 1160   | 1210   | 1260                             | 1310                      | 795    | 855      | 915       |
| 052 SOFA LEFT ARM                  | 78X40X30/39   | 2735    | 2855                  | 2975   | 3095   | 3215                             | 3335                      | 2080   | 2170     | 2260      |
| 053 SOFA RIGHT ARM                 | 78X40X30/39   | 2735    | 2855                  | 2975   | 3095   | 3215                             | 3335                      | 2080   | 2170     | 2260      |
| 055 SQUARE CORNER                  | 44X44X30/39   | 1945    | 2040                  | 2135   | 2230   | 2325                             | 2420                      | 1490   | 1540     | 1590      |
| 056 CHAIR RIGHT ARM                | 31X40X30/39   | 1365    | 1450                  | 1535   | 1620   | 1705                             | 1790                      | 1030   | 1080     | 1130      |
| 057 CHAIR LEFT ARM                 | 31X40X30/39   | 1365    | 1450                  | 1535   | 1620   | 1705                             | 1790                      | 1030   | 1080     | 1130      |
| 061 LOVESEAT RIGHT ARM             | 54X40X30/39   | 2180    | 2290                  | 2400   | 2510   | 2620                             | 2730                      | 1635   | 1715     | 1795      |



## CORRADO

Features: Manual adjustable headrest included (2 on square corner). Stitching: Small thread in fabric & large flat thread in leather. Memory foam in seat cushions.

NOTE: 2 recliner seats SEPARATED by a SQUARE CORNER or TABLE cannot be opened at the same time.

OPTIONS - Specify on your order + SKETCH of your config.:

Leg: LG64 metal or LG08 wood (specify colour).

TABLE #154: Specify colour of wood table top.

043 & 163 Chairs: with wood base (specify colour).

Accessories: Anchorage \$35 ea. | Plastic Swivel tray & Wine Glass holder \$35 ea. | Wood Swivel tray \$60 ea. | Tablet holder \$40 ea. & LED Lamp \$35 ea.

\*\*MANUAL RECLINER N/A.\*\* Motorized mechanism included in price of recliner chair items. For Battery Pack add \$160/mechanism.

| Description                            | L x D x H     | Leather |                       |  |  |                                  |                           | Fabric |          |           |
|--|---------------|---------|-----------------------|--|--|----------------------------------|---------------------------|--------|----------|-----------|
|  |               | 10      | 20<br>Madras<br>Softy | 30<br>Hugo<br>Fantasy<br>Illusion<br>Tucson<br>Utah<br>Vintage<br>Wild Laredo<br>Yukon | 40<br>Elegance<br>Princess<br>Santiago<br>Sensation<br>Sunset<br>Trina<br>Victoria | 50<br>Bull<br>Cassiope<br>Dublin | 60<br>Caress<br>Ultrasued | A      | B<br>COM | C<br>alta |
| 071 ARMLESS RECLINING CHAIR            | 23,5X40X30/39 | 1420    | 1475                  | 1530   | 1585   | 1640                             | 1695                      | 1170   | 1235     | 1300      |
| 086 ARMLESS LOVESEAT BUMPER LEFT       | 68X40X30/39   | 2185    | 2300                  | 2415   | 2530   | 2645                             | 2760                      | 1655   | 1730     | 1805      |
| 088 ARMLESS CHAIR BUMPER LEFT          | 45X40X30/39   | 1370    | 1460                  | 1550   | 1640   | 1730                             | 1820                      | 1055   | 1115     | 1175      |
| 089 ARMLESS CHAIR BUMPER RIGHT         | 45X40X30/39   | 1370    | 1460                  | 1550   | 1640   | 1730                             | 1820                      | 1055   | 1115     | 1175      |
| 095 APARTMENT SOFA                     | 75X40X30/39   | 2735    | 2885                  | 3035   | 3185   | 3335                             | 3485                      | 2075   | 2160     | 2245      |
| 096 APARTMENT SOFA LEFT ARM            | 68X40X30/39   | 2435    | 2565                  | 2695   | 2825   | 2955                             | 3085                      | 1825   | 1915     | 2005      |
| 097 APARTMENT SOFA RIGHT ARM           | 68X40X30/39   | 2435    | 2565                  | 2695   | 2825   | 2955                             | 3085                      | 1825   | 1915     | 2005      |
| 124 STORAGE OTTOMAN                    | 30X22X17      | 705     | 730                   | 755  | 780  | 805                              | 830                       | 605    | 615      | 625       |
| 154 UPHOLSTERED ANGULAR TABLE          | 7/34x33.5x19  | 600     | 625                   | 650  | 675  | 700                              | 725                       | 515    | 530      | 545       |
| 163 DBL SWIVEL ROCKING RECLINER CHAIR  | 33 x 34 x 42  | 2200    | 2315                  | 2430   | 2545   | 2660                             | 2775                      | 1795   | 1840     | 1885      |
| 165 DOUBLE RECLINING CHAIR             | 45X40X30/39   | 2160    | 2255                  | 2350   | 2445   | 2540                             | 2635                      | 1710   | 1785     | 1860      |
| 167 APARTMENT SOFA NO ARM BUMPER LEFT  | 82X40X30/39   | 2440    | 2580                  | 2720   | 2860   | 3000                             | 3140                      | 1835   | 1935     | 2035      |
| 168 APARTMENT SOFA NO ARM BUMPER RIGHT | 82X40X30/39   | 2440    | 2580                  | 2720   | 2860   | 3000                             | 3140                      | 1835   | 1935     | 2035      |
| 169 DOUBLE RECLINING CHAIR LEFT ARM    | 38X40X30/39   | 1830    | 1925                  | 2020   | 2115   | 2210                             | 2305                      | 1490   | 1545     | 1600      |
| 170 DOUBLE RECLINING CHAIR RIGHT ARM   | 38X40X30/39   | 1830    | 1925                  | 2020   | 2115   | 2210                             | 2305                      | 1490   | 1545     | 1600      |
| 171 ARMLESS DOUBLE RECLINING CHAIR     | 30,5X40X30/39 | 1525    | 1590                  | 1655   | 1720   | 1785                             | 1850                      | 1240   | 1305     | 1370      |
| 173 DOUBLE LOUNGE CHAIR LEFT ARM       | 38X62X30/39   | 1755    | 1840                  | 1925   | 2010   | 2095                             | 2180                      | 1325   | 1390     | 1455      |
| 174 DOUBLE LOUNGE CHAIR RIGHT ARM      | 38X62X30/39   | 1755    | 1840                  | 1925   | 2010   | 2095                             | 2180                      | 1325   | 1390     | 1455      |
| 175 DOUBLE CHAIR LEFT ARM              | 38X40X30/39   | 1470    | 1550                  | 1630   | 1710   | 1790                             | 1870                      | 1125   | 1175     | 1225      |
| 176 DOUBLE CHAIR RIGHT ARM             | 38X40X30/39   | 1470    | 1550                  | 1630   | 1710   | 1790                             | 1870                      | 1125   | 1175     | 1225      |
| 177 ARMLESS DOUBLE CHAIR               | 30,5X40X30/39 | 1150    | 1225                  | 1300   | 1375   | 1450                             | 1525                      | 880    | 940      | 1000      |
| 178 ARMLESS DOUBLE CHAIR BUMPER LEFT   | 52X40X30/39   | 1485    | 1575                  | 1665   | 1755   | 1845                             | 1935                      | 1140   | 1205     | 1270      |
| 179 ARMLESS DOUBLE CHAIR BUMPER RIGHT  | 52X40X30/39   | 1485    | 1575                  | 1665   | 1755   | 1845                             | 1935                      | 1140   | 1205     | 1270      |

## CDN Price List

### CORRADO

| Description                | L x D x H     | Leather |                       |  |  |                                  |                           | Fabric |          |           |
|----------------------------|---------------|---------|-----------------------|--|--|----------------------------------|---------------------------|--------|----------|-----------|
|                            |               | 10      | 20<br>Madras<br>Softy | 30<br>Hugo<br>Fantasy<br>Illusion<br>Tucson<br>Utah<br>Vintage<br>Wild Laredo<br>Yukon | 40<br>Elegance<br>Princess<br>Santiago<br>Sensation<br>Sunset<br>Trina<br>Victoria | 50<br>Bull<br>Cassiope<br>Dublin | 60<br>Caress<br>Ultrasued | A      | B<br>COM | C<br>alta |
| <b>CONFIGURATIONS</b>      |               |         |                       |  |  |                                  |                           |        |          |           |
| A CONFIG (169-170)         | 76X40X30/39   | 3660    | 3850                  | 4040   | 4230   | 4420                             | 4610                      | 2980   | 3090     | 3200      |
| B CONFIG (169-171-174)     | 107X62X30/39  | 5110    | 5355                  | 5600   | 5845   | 6090                             | 6335                      | 4055   | 4240     | 4425      |
| C CONFIG (096-055-171-170) | 112X113X30/39 | 7735    | 8120                  | 8505   | 8890   | 9275                             | 9660                      | 6045   | 6305     | 6565      |
| D CONFIG (169-171-055-179) | 113X96X30/39  | 6785    | 7130                  | 7475   | 7820   | 8165                             | 8510                      | 5360   | 5595     | 5830      |
| J CONFIG (041-042)         | 62X40X30/39   | 3490    | 3630                  | 3770   | 3910   | 4050                             | 4190                      | 2800   | 2930     | 3060      |
| K CONFIG (041-071-005)     | 86X62X30/39   | 4765    | 4970                  | 5175   | 5380   | 5585                             | 5790                      | 3770   | 3980     | 4190      |
| L CONFIG (012-055-071-042) | 98X99X30/39   | 7290    | 7620                  | 7950   | 8280   | 8610                             | 8940                      | 5695   | 5955     | 6215      |
| M CONFIG (041-071-055-089) | 99X89X30/39   | 6480    | 6790                  | 7100   | 7410   | 7720                             | 8030                      | 5115   | 5355     | 5595      |

# SPECIFICATIONS



## CORRADO

LINEA 30 Collection



Conçu et fabriqué fièrement au Canada  
Proudly designed and made in Canada

Nos produits sont fabriqués à la main et des variations mineures peuvent survenir

Our product is hand-made and minor variations can occur.

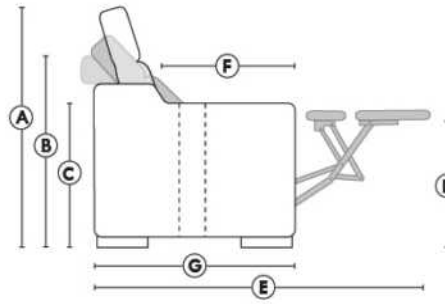

□ Appui-tête levé / Headrest up  
■ Appui-tête baissé / Headrest down  
■ Complètement incliné / Fully reclined

- (A) Hauteur complète 39" Total Height
- (B) Hauteur appui-tête baissé 30" Height headrest down
- (C) Hauteur du bras 23" Arm Height
- (D) Hauteur du siège 19,5" Seat height
- (E) Profondeur inclinée 63" Depth fully reclined
- (F) Profondeur d'assise 20" Seat depth
- (G) Profondeur appui-tête monté 37,5" Depth with headrest up

### BRAS | ARMS

Contrôle de l'inclinaison situé à l'intérieur du bras  
Recliner control located on the inside of the arm.

Option d'accessoires disponible  
Accessories option, available

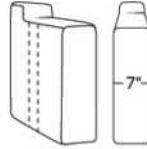

### FAUTEUIL BERÇANT PIVOTANT INCLINABLE SWIVEL ROCKING MOTION CHAIR

Dégagement mural de 16" Wall clearance  
Hauteur de 42" Height  
Largeur de bras 6" Arms width  
Option base de bois | Wood base option

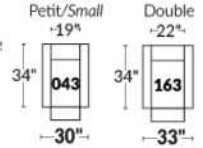

### SIÈGE 23" DE LARGE | 23" SEAT WIDTH

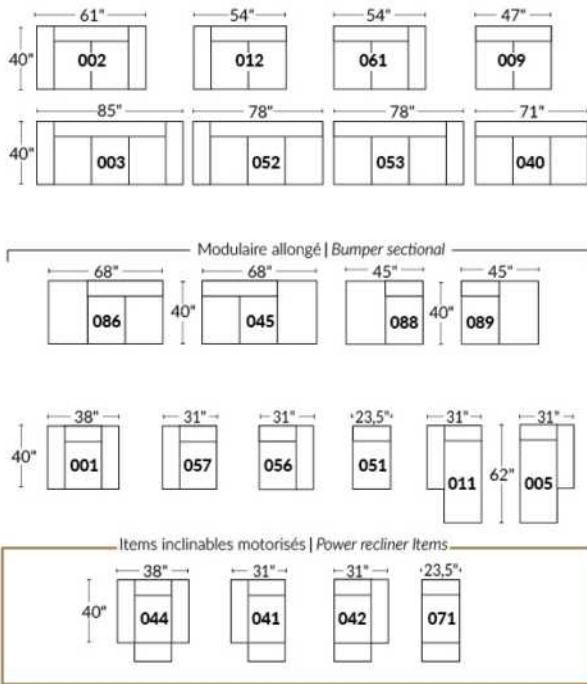

### SIÈGE 30" DE LARGE | 30" SEAT WIDTH

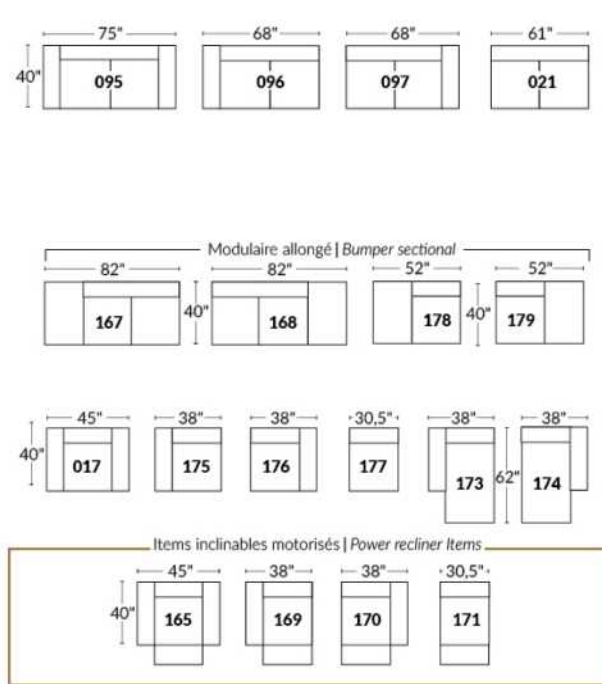

### Autres | Others

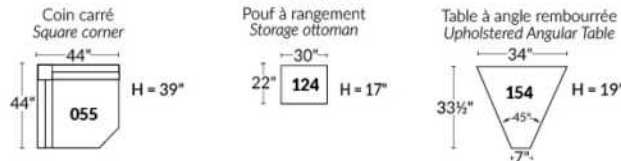

### EXEMPLE 23" EXAMPLE

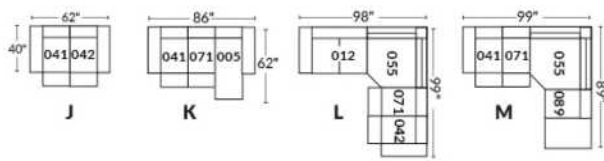

### EXEMPLE 30" EXAMPLE

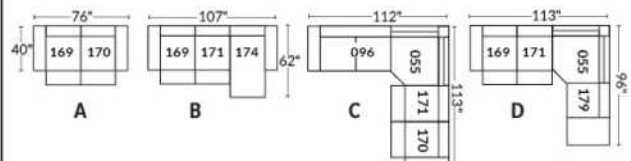

## DARIO

Features: Manual adjustable headrest included with all items (2 with square corner). Headrest STATIONARY on Wedge (050). Stitching: Small "French Stitch" in fabric & in leather. Swivel Rocking Recliner Chairs (items 043 & 163 only): seat cushions with 1" memory foam.

Note: 2 recliner seats separated by a wedge (050) or square corner (055) cannot be opened at the same time.

OPTIONS - Provide SKETCH of your config.:

Small 6" Arm: at same price.

Leg (specify colour): on LARGE arm: LG103 wood or LG189 metal (Black or Chrome). SMALL Arm: LG08 wood or LG64 metal.

Choice of Seat Depth: 20" or \*22". The \*22" seat depth N/A on chairs #043 & #163.

043 & 163 Chairs: with wood base (specify colour).

Foam (Extra Firm or Memory): Add \$15/seat. Bumper section counts as 1 seat & lounge chairs as 2 seats.

Motorized recliner mechanism with touch-sensor button add \$160/mechanism. | For Battery Pack: add \$320/mechanism.

| Description                        | L x D x H     | Leather |                       |  |  |                                  |                           | Fabric |          |           |
|------------------------------------|---------------|---------|-----------------------|--|--|----------------------------------|---------------------------|--------|----------|-----------|
|                                    |               | 10      | 20<br>Madras<br>Softy | 30<br>Hugo<br>Fantasy<br>Illusion<br>Tucson<br>Utah<br>Vintage<br>Wild Laredo<br>Yukon | 40<br>Elegance<br>Princess<br>Santiago<br>Sensation<br>Sunset<br>Trina<br>Victoria | 50<br>Bull<br>Cassiope<br>Dublin | 60<br>Caress<br>Ultrasued | A      | B<br>COM | C<br>alta |
| 001 CHAIR                          | 44X40X33/40   | 1630    | 1725                  | 1820   | 1915   | 2010                             | 2105                      | 1235   | 1295     | 1355      |
| 002 LOVESEAT                       | 67X40X33/40   | 2365    | 2485                  | 2605   | 2725   | 2845                             | 2965                      | 1800   | 1865     | 1930      |
| 003 SOFA                           | 91X40X33/40   | 2890    | 3045                  | 3200   | 3355   | 3510                             | 3665                      | 2180   | 2275     | 2370      |
| 005 LOUNGE CHAIR RIGHT ARM         | 34X62X33/40   | 1555    | 1625                  | 1695   | 1765   | 1835                             | 1905                      | 1155   | 1225     | 1295      |
| 009 ARMLESS LOVESEAT               | 47X40X33/40   | 1770    | 1835                  | 1900   | 1965   | 2030                             | 2095                      | 1330   | 1390     | 1450      |
| 011 LOUNGE CHAIR LEFT ARM          | 34X62X33/40   | 1555    | 1625                  | 1695   | 1765   | 1835                             | 1905                      | 1155   | 1225     | 1295      |
| 012 LOVESEAT LEFT ARM              | 57X40X33/40   | 2070    | 2160                  | 2250   | 2340   | 2430                             | 2520                      | 1575   | 1640     | 1705      |
| 017 DOUBLE CHAIR                   | 51X40X33/40   | 1750    | 1840                  | 1930   | 2020   | 2110                             | 2200                      | 1320   | 1370     | 1420      |
| 021 APARTMENT SOFA NO ARM          | 61X40X33/40   | 2010    | 2090                  | 2170   | 2250   | 2330                             | 2410                      | 1510   | 1600     | 1690      |
| 040 ARMLESS SOFA                   | 71X40X33/40   | 2280    | 2360                  | 2440   | 2520   | 2600                             | 2680                      | 1725   | 1815     | 1905      |
| 041 RECLINING CHAIR LEFT ARM       | 34X40X33/40   | 1510    | 1585                  | 1660   | 1735   | 1810                             | 1885                      | 1175   | 1230     | 1285      |
| 042 RECLINING CHAIR RIGHT ARM      | 34X40X33/40   | 1510    | 1585                  | 1660   | 1735   | 1810                             | 1885                      | 1175   | 1230     | 1285      |
| 043 SWIVEL ROCKING RECLINING CHAIR | 30x34x42      | 1965    | 2060                  | 2155   | 2250   | 2345                             | 2440                      | 1600   | 1645     | 1690      |
| 044 RECLINER CHAIR                 | 44X40X33/40   | 1805    | 1910                  | 2015   | 2120   | 2225                             | 2330                      | 1425   | 1480     | 1535      |
| 045 ARMLESS LOVESEAT BUMPER RIGHT  | 68X40X33/40   | 2080    | 2175                  | 2270   | 2365   | 2460                             | 2555                      | 1580   | 1650     | 1720      |
| 050 WEDGE                          | 49X49X33      | 1555    | 1640                  | 1725   | 1810   | 1895                             | 1980                      | 1100   | 1150     | 1200      |
| 051 ARMLESS CHAIR                  | 23,5X40X33/40 | 1005    | 1055                  | 1105   | 1155   | 1205                             | 1255                      | 765    | 820      | 875       |
| 052 SOFA LEFT ARM                  | 81X40X33/40   | 2590    | 2695                  | 2800   | 2905   | 3010                             | 3115                      | 1950   | 2040     | 2130      |
| 053 SOFA RIGHT ARM                 | 81X40X33/40   | 2590    | 2695                  | 2800   | 2905   | 3010                             | 3115                      | 1950   | 2040     | 2130      |
| 055 SQUARE CORNER                  | 44X44X33/40   | 1825    | 1925                  | 2025   | 2125   | 2225                             | 2325                      | 1390   | 1455     | 1520      |
| 056 CHAIR RIGHT ARM                | 34X40X33/40   | 1320    | 1395                  | 1470   | 1545   | 1620                             | 1695                      | 1000   | 1045     | 1090      |
| 057 CHAIR LEFT ARM                 | 34X40X33/40   | 1320    | 1395                  | 1470   | 1545   | 1620                             | 1695                      | 1000   | 1045     | 1090      |

## DARIO

Features: Manual adjustable headrest included with all items (2 with square corner). Headrest STATIONARY on Wedge (050). Stitching: Small "French Stitch" in fabric & in leather. Swivel Rocking Recliner Chairs (items 043 & 163 only): seat cushions with 1" memory foam.

Note: 2 recliner seats separated by a wedge (050) or square corner (055) cannot be opened at the same time.

OPTIONS - Provide SKETCH of your config.:

Small 6" Arm: at same price.

Leg (specify colour): on LARGE arm: LG103 wood or LG189 metal (Black or Chrome). SMALL Arm: LG08 wood or LG64 metal.

Choice of Seat Depth: 20" or \*22". The \*22" seat depth N/A on chairs #043 & #163.

043 & 163 Chairs: with wood base (specify colour).

Foam (Extra Firm or Memory): Add \$15/seat. Bumper section counts as 1 seat & lounge chairs as 2 seats.

Motorized recliner mechanism with touch-sensor button add \$160/mechanism. | For Battery Pack: add \$320/mechanism.

| Description                            | L x D x H     | Leather |                       |  |  |                                  |                           | Fabric |          |           |
|--|---------------|---------|-----------------------|--|--|----------------------------------|---------------------------|--------|----------|-----------|
|  |               | 10      | 20<br>Madras<br>Softy | 30<br>Hugo<br>Fantasy<br>Illusion<br>Tucson<br>Utah<br>Vintage<br>Wild Laredo<br>Yukon | 40<br>Elegance<br>Princess<br>Santiago<br>Sensation<br>Sunset<br>Trina<br>Victoria | 50<br>Bull<br>Cassiope<br>Dublin | 60<br>Caress<br>Ultrasued | A      | B<br>COM | C<br>alta |
| 061 LOVESEAT RIGHT ARM                 | 57X40X33/40   | 2070    | 2160                  | 2250   | 2340   | 2430                             | 2520                      | 1575   | 1640     | 1705      |
| 071 ARMLESS RECLINING CHAIR            | 23,5X40X33/40 | 1185    | 1250                  | 1315   | 1380   | 1445                             | 1510                      | 955    | 1020     | 1085      |
| 086 ARMLESS LOVESEAT BUMPER LEFT       | 68X40X33/40   | 2080    | 2175                  | 2270   | 2365   | 2460                             | 2555                      | 1580   | 1650     | 1720      |
| 088 ARMLESS CHAIR BUMPER LEFT          | 45X40X33/40   | 1330    | 1410                  | 1490   | 1570   | 1650                             | 1730                      | 1005   | 1050     | 1095      |
| 089 ARMLESS CHAIR BUMPER RIGHT         | 45X40X33/40   | 1330    | 1410                  | 1490   | 1570   | 1650                             | 1730                      | 1005   | 1050     | 1095      |
| 095 APARTMENT SOFA                     | 81X40X33/40   | 2625    | 2780                  | 2935   | 3090   | 3245                             | 3400                      | 1980   | 2070     | 2160      |
| 096 APARTMENT SOFA LEFT ARM            | 71X40X33/40   | 2315    | 2430                  | 2545   | 2660   | 2775                             | 2890                      | 1750   | 1835     | 1920      |
| 097 APARTMENT SOFA RIGHT ARM           | 71X40X33/40   | 2315    | 2430                  | 2545   | 2660   | 2775                             | 2890                      | 1750   | 1835     | 1920      |
| 124 STORAGE OTTOMAN                    | 30X22X17      | 705     | 730                   | 755  | 780  | 805                              | 830                       | 605    | 615      | 625       |
| 163 DBL SWIVEL ROCKING RECLINER CHAIR  | 33 x 34 x 42  | 2010    | 2125                  | 2240   | 2355   | 2470                             | 2585                      | 1605   | 1650     | 1695      |
| 165 DOUBLE RECLINING CHAIR             | 51X40X33/40   | 1920    | 2025                  | 2130   | 2235   | 2340                             | 2445                      | 1495   | 1565     | 1635      |
| 167 APARTMENT SOFA NO ARM BUMPER LEFT  | 82X40X33/40   | 2320    | 2440                  | 2560   | 2680   | 2800                             | 2920                      | 1770   | 1855     | 1940      |
| 168 APARTMENT SOFA NO ARM BUMPER RIGHT | 82X40X33/40   | 2320    | 2440                  | 2560   | 2680   | 2800                             | 2920                      | 1770   | 1855     | 1940      |
| 169 DOUBLE RECLINING CHAIR LEFT ARM    | 41X40X33/40   | 1605    | 1690                  | 1775   | 1860   | 1945                             | 2030                      | 1285   | 1335     | 1385      |
| 170 DOUBLE RECLINING CHAIR RIGHT ARM   | 41X40X33/40   | 1605    | 1690                  | 1775   | 1860   | 1945                             | 2030                      | 1285   | 1335     | 1385      |
| 171 ARMLESS DOUBLE RECLINING CHAIR     | 30,5X40X33/40 | 1305    | 1355                  | 1405   | 1455   | 1505                             | 1555                      | 1030   | 1095     | 1160      |
| 173 DOUBLE LOUNGE CHAIR LEFT ARM       | 41X62X33/40   | 1695    | 1785                  | 1875   | 1965   | 2055                             | 2145                      | 1295   | 1375     | 1455      |
| 174 DOUBLE LOUNGE CHAIR RIGHT ARM      | 41X62X33/40   | 1695    | 1785                  | 1875   | 1965   | 2055                             | 2145                      | 1295   | 1375     | 1455      |
| 175 DOUBLE CHAIR LEFT ARM              | 41X40X33/40   | 1420    | 1500                  | 1580   | 1660   | 1740                             | 1820                      | 1085   | 1145     | 1205      |
| 176 DOUBLE CHAIR RIGHT ARM             | 41X40X33/40   | 1420    | 1500                  | 1580   | 1660   | 1740                             | 1820                      | 1085   | 1145     | 1205      |
| 177 ARMLESS DOUBLE CHAIR               | 30,5X40X33/40 | 1120    | 1175                  | 1230   | 1285   | 1340                             | 1395                      | 845    | 905      | 965       |
| 178 ARMLESS DOUBLE CHAIR BUMPER LEFT   | 52X40X33/40   | 1440    | 1535                  | 1630   | 1725   | 1820                             | 1915                      | 1095   | 1150     | 1205      |

## DARIO

Features: Manual adjustable headrest included with all items (2 with square corner). Headrest STATIONARY on Wedge (050). Stitching: Small "French Stitch" in fabric & in leather. Swivel Rocking Recliner Chairs (items 043 & 163 only): seat cushions with 1" memory foam.

Note: 2 recliner seats separated by a wedge (050) or square corner (055) cannot be opened at the same time.

OPTIONS - Provide SKETCH of your config.:

Small 6" Arm: at same price.

Leg (specify colour): on LARGE arm: LG103 wood or LG189 metal (Black or Chrome). SMALL Arm: LG08 wood or LG64 metal.

Choice of Seat Depth: 20" or \*22". The \*22" seat depth N/A on chairs #043 & #163.

043 & 163 Chairs: with wood base (specify colour).

Foam (Extra Firm or Memory): Add \$15/seat. Bumper section counts as 1 seat & lounge chairs as 2 seats.

Motorized recliner mechanism with touch-sensor button add \$160/mechanism. | For Battery Pack: add \$320/mechanism.

| Description                           | L x D x H     | Leather |                       |  |  |                                  |                           | Fabric |          |           |
|---------------------------------------|---------------|---------|-----------------------|--|--|----------------------------------|---------------------------|--------|----------|-----------|
|                                       |               | 10      | 20<br>Madras<br>Softy | 30<br>Hugo<br>Fantasy<br>Illusion<br>Tucson<br>Utah<br>Vintage<br>Wild Laredo<br>Yukon | 40<br>Elegance<br>Princess<br>Santiago<br>Sensation<br>Sunset<br>Trina<br>Victoria | 50<br>Bull<br>Cassiope<br>Dublin | 60<br>Caress<br>Ultrasued | A      | B<br>COM | C<br>alta |
| 179 ARMLESS DOUBLE CHAIR BUMPER RIGHT | 52X40X33/40   | 1440    | 1535                  | 1630   | 1725   | 1820                             | 1915                      | 1095   | 1150     | 1205      |
| <b>CONFIGURATIONS</b>                 |               |         |                       |  |  |                                  |                           |        |          |           |
| A CONFIG (169-170)                    | 82X40X33/40   | 3210    | 3380                  | 3550   | 3720   | 3890                             | 4060                      | 2570   | 2670     | 2770      |
| B CONFIG (169-171-174)                | 113X62X33/40  | 4605    | 4830                  | 5055   | 5280   | 5505                             | 5730                      | 3610   | 3805     | 4000      |
| C CONFIG (096-055-171-170)            | 115X116X33/40 | 7050    | 7400                  | 7750   | 8100   | 8450                             | 8800                      | 5455   | 5720     | 5985      |
| D CONFIG (169-171-055-179)            | 116X96X33/40  | 6175    | 6505                  | 6835   | 7165   | 7495                             | 7825                      | 4800   | 5035     | 5270      |
| J CONFIG (041-042)                    | 68X40X33/40   | 3020    | 3170                  | 3320   | 3470   | 3620                             | 3770                      | 2350   | 2460     | 2570      |
| K CONFIG (041-071-005)                | 92X62X33/40   | 4250    | 4460                  | 4670   | 4880   | 5090                             | 5300                      | 3285   | 3475     | 3665      |
| L CONFIG (012-055-071-042)            | 101X102X33/40 | 6590    | 6920                  | 7250   | 7580   | 7910                             | 8240                      | 5095   | 5345     | 5595      |
| M CONFIG (041-071-055-089)            | 102X89X33/40  | 5850    | 6170                  | 6490   | 6810   | 7130                             | 7450                      | 4525   | 4755     | 4985      |





# DARIO

PARALLELE  
Collection 33

Jaymar

Conçu et fabriqué fièrement au Canada  
Proudly designed and made in Canada

Nos produits sont fabriqués à la main et des variations mineures peuvent survenir.

Our product is hand-made and minor variations can occur.

## SPECIFICATIONS

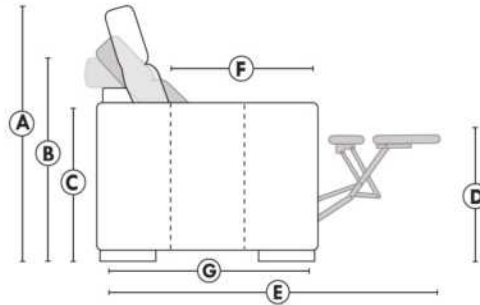

- Appui-tête levé Headrest up
- Appui-tête baissé Headrest down
- Complètement incliné Fully reclined

- A** Hauteur complète 40" Total Height
- B** Hauteur appui-tête baissé 33" Height headrest down
- C** Hauteur du bras 24" Arm Height
- D** Hauteur du siège 19,5" Seat height
- E** Profondeur inclinée 65" Depth fully reclined
- F** Profondeur d'assise 20" ou/ or 22" Seat depth
- G** Profondeur appui-tête monté 37,5" Depth with headrest up

## BRAS | ARMS

Option de bras:  
Bras Régulier Large 10" ou Petit bras 6"

Arm option  
Regular arm Large 10" or Small arm 6"

Contrôle de l'inclinaison situé à l'intérieur du bras  
Recliner control located on the inside of the arm.

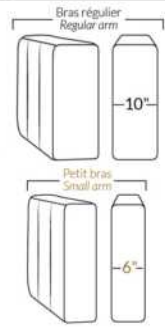

## FAUTEUIL BERÇANT PIVOTANT INCLINABLE SWIVEL ROCKING MOTION CHAIR

Dégagement mural de 16" Wall clearance  
Hauteur de 42" Height  
Largeur de bras 6" Arms width  
Option base de bois | Wood base option

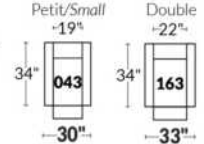

## SIÈGE 23" DE LARGE | 23" SEAT WIDTH

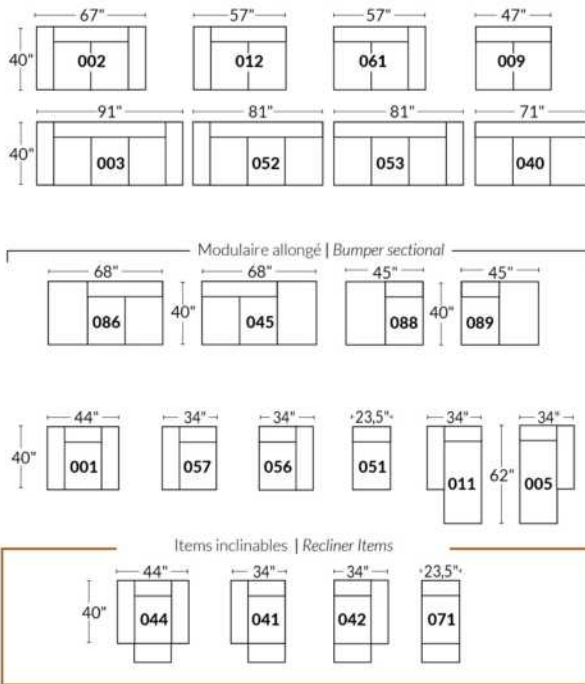

## SIÈGE 30" DE LARGE | 30" SEAT WIDTH

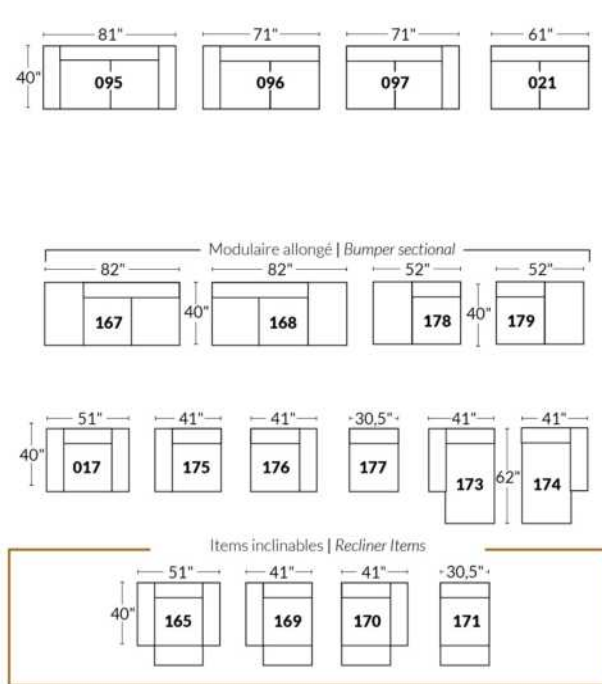

## Autres | Others

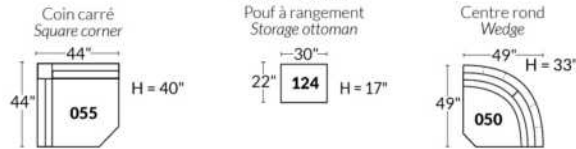

## EXEMPLE 23" EXAMPLE

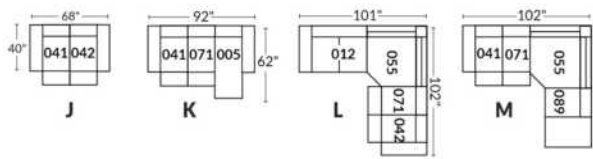

## EXEMPLE 30" EXAMPLE

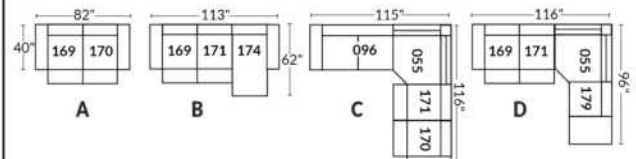

## CDN Price List

### ECLIPSE

FEATURE: Seat cushions and arms contain feathers. Back & Seat cushions reversable. In LEATHER: Backs & Seats will have parallel decorative seams. Back cushions will be semi attached with a zipper.

LEGS: LG189 metal or LG103 wood. If wood, specify colour.

COMBO: Cover #2 on backs & seats.

| Description                    | L x D x H     | Leather |                       |  |  |                                  |                           | Fabric |          |           |
|--------------------------------|---------------|---------|-----------------------|--|--|----------------------------------|---------------------------|--------|----------|-----------|
|                                |               | 10      | 20<br>Madras<br>Softy | 30<br>Hugo<br>Fantasy<br>Illusion<br>Tucson<br>Utah<br>Vintage<br>Wild Laredo<br>Yukon | 40<br>Elegance<br>Princess<br>Santiago<br>Sensation<br>Sunset<br>Trina<br>Victoria | 50<br>Bull<br>Cassiope<br>Dublin | 60<br>Caress<br>Ultrasued | A      | B<br>COM | C<br>alta |
| 002 LOVESEAT                   | 72 x 41 x 34  | 2585    | 2670                  | 2755   | 2840   | 2925                             | 3010                      | 1740   | 1825     | 1910      |
| 005 LOUNGE CHAIR RIGHT ARM     | 45 x 70 x 34  | 2100    | 2185                  | 2270   | 2355   | 2440                             | 2525                      | 1555   | 1625     | 1695      |
| 006 OTTOMAN                    | 35 x 24 x 17  | 705     | 730                   | 755  | 780  | 805                              | 830                       | 515    | 525      | 535       |
| 011 LOUNGE CHAIR LEFT ARM      | 45 x 70 x 34  | 2100    | 2185                  | 2270   | 2355   | 2440                             | 2525                      | 1555   | 1625     | 1695      |
| 017 DOUBLE CHAIR               | 55 x 41 x 34  | 2035    | 2115                  | 2195   | 2275   | 2355                             | 2435                      | 1510   | 1575     | 1640      |
| 021 APARTMENT SOFA NO ARM      | 70 x 41 x 34  | 2240    | 2355                  | 2470   | 2585   | 2700                             | 2815                      | 1720   | 1825     | 1930      |
| 051 ARMLESS CHAIR              | 35 x 41 x 34  | 1210    | 1305                  | 1400   | 1495   | 1590                             | 1685                      | 1110   | 1165     | 1220      |
| 055 SQUARE CORNER              | 45 x 45 x 34  | 1310    | 1365                  | 1420   | 1475   | 1530                             | 1585                      | 1130   | 1175     | 1220      |
| 056 CHAIR RIGHT ARM            | 45 x 41 x 34  | 1630    | 1720                  | 1810   | 1900   | 1990                             | 2080                      | 1320   | 1380     | 1440      |
| 057 CHAIR LEFT ARM             | 45 x 41 x 34  | 1630    | 1720                  | 1810   | 1900   | 1990                             | 2080                      | 1320   | 1380     | 1440      |
| 088 ARMLESS CHAIR BUMPER LEFT  | 56 x 41 x 34  | 1580    | 1665                  | 1750   | 1835   | 1920                             | 2005                      | 1250   | 1310     | 1370      |
| 089 ARMLESS CHAIR BUMPER RIGHT | 56 x 41 x 34  | 1580    | 1665                  | 1750   | 1835   | 1920                             | 2005                      | 1250   | 1310     | 1370      |
| 095 APARTMENT SOFA             | 90 x 41 x 34  | 3045    | 3160                  | 3275   | 3390   | 3505                             | 3620                      | 2085   | 2195     | 2305      |
| 096 APARTMENT SOFA LEFT ARM    | 80 x 41 x 34  | 2615    | 2735                  | 2855   | 2975   | 3095                             | 3215                      | 1905   | 2025     | 2145      |
| 097 APARTMENT SOFA RIGHT ARM   | 80 x 41 x 34  | 2615    | 2735                  | 2855   | 2975   | 3095                             | 3215                      | 1905   | 2025     | 2145      |
| <b>CONFIGURATIONS</b>          |               |         |                       |  |  |                                  |                           |        |          |           |
| A CONF. A (096-055-056)        | 90X125/41X34  | 5555    | 5820                  | 6085   | 6350   | 6615                             | 6880                      | 4355   | 4580     | 4805      |
| B CONF. B (088-055-097)        | 101X125X34    | 5505    | 5765                  | 6025   | 6285   | 6545                             | 6805                      | 4285   | 4510     | 4735      |
| C CONF. C (011-051-055-089)    | 125X70/101X34 | 6200    | 6520                  | 6840   | 7160   | 7480                             | 7800                      | 5045   | 5275     | 5505      |
| D CONF. D (011-097)            | 125X70/41X34  | 4715    | 4920                  | 5125   | 5330   | 5535                             | 5740                      | 3460   | 3650     | 3840      |
| E CONF. E (057-097)            | 125X41X34     | 4245    | 4455                  | 4665   | 4875   | 5085                             | 5295                      | 3225   | 3405     | 3585      |
| F CONF. F (097-055-021-005)    | 160X125/70X34 | 8265    | 8640                  | 9015   | 9390   | 9765                             | 10140                     | 6310   | 6650     | 6990      |

# ECLIPSE



Hauteur complète 34" | Hauteur de siège 18" | Hauteur devant bras 24" | Profondeur d'assise 24"  
 Total Height 34" | Seat Height 18" | Arm Height 24" | Seat Depth 24"

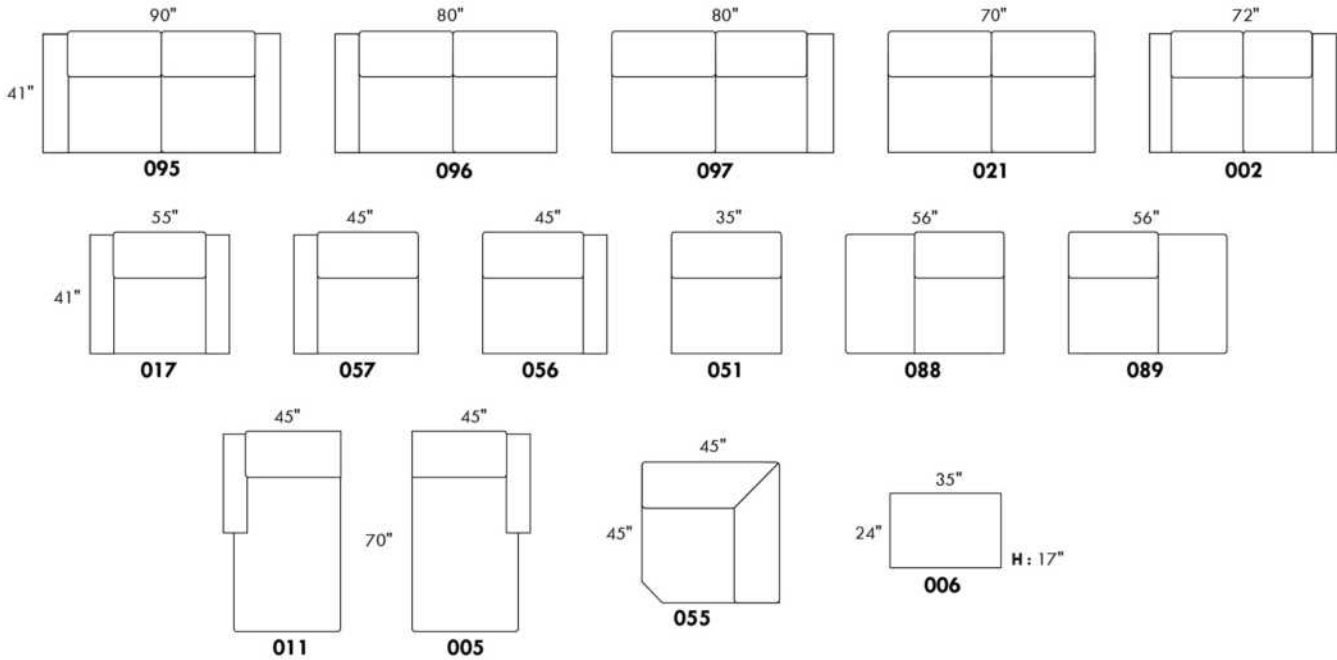

## CONFIGURATIONS

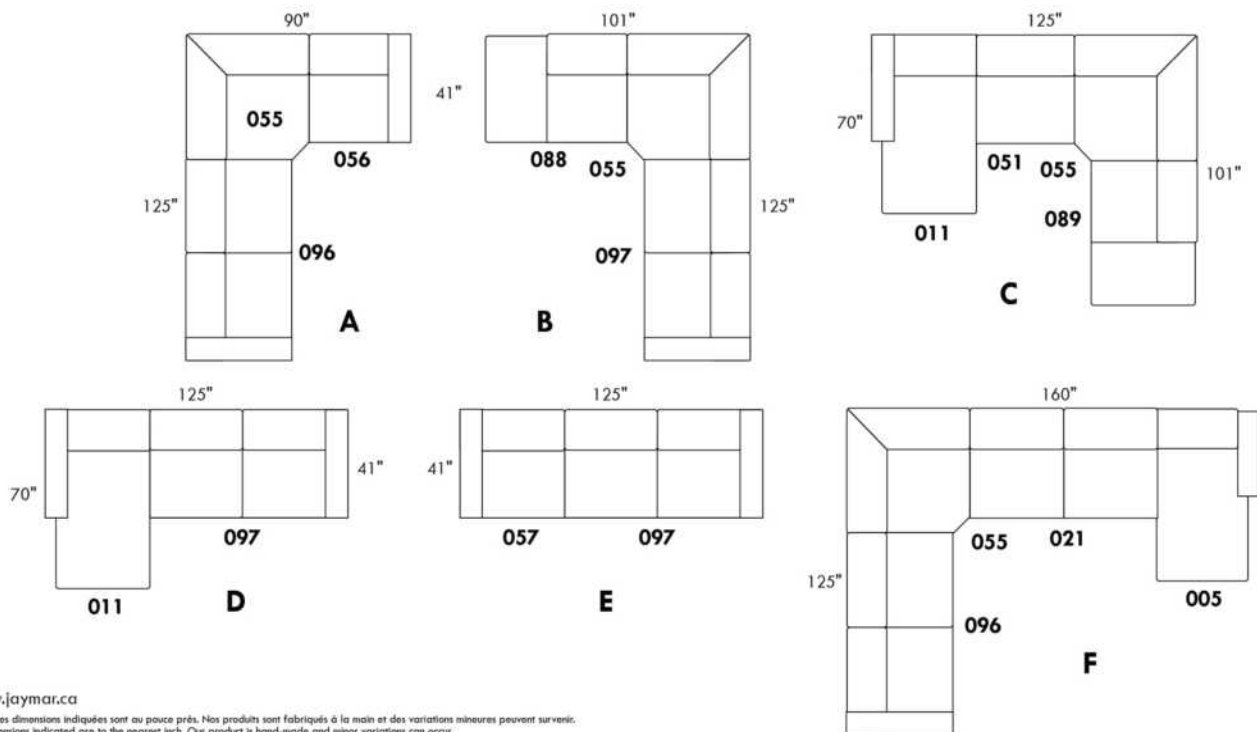

www.jaymar.ca

Toutes les dimensions indiquées sont au pouce près. Nos produits sont fabriqués à la main et des variations mineures peuvent survenir.  
 All dimensions indicated are to the nearest inch. Our product is hand-made and minor variations can occur.



## EDGE

Features: Manual adjustable headrest included with all items (2 with square corner). Stitching: Small thread in fabric and large flat thread in leather. Memory foam in seat cushions. Upholstery of top of arm with feathers. Cupholder N/A with this style.

NOTE: 2 recliner seats SEPARATED by a SQUARE CORNER or UPHOLSTERED TABLE cannot be opened at the same time.

OPTIONS - Specify on your order + SKETCH of your config:  
Leg: LG189 metal (Black or Chrome) or LG103 wood (specify colour).  
Table (154): Specify colour of wood table top.  
WITHOUT METAL insert on arm, add \$50/order.  
043 & 163 Chairs: with wood base (specify colour).

\*\*MANUAL RECLINER N/A.\*\* Motorized mechanism included in price of recliner chair items. For Battery Pack add \$160/mechanism.

| Description                        | L x D x H     | Leather |                       |  |  |                                  |                           | Fabric |          |           |
|------------------------------------|---------------|---------|-----------------------|--|--|----------------------------------|---------------------------|--------|----------|-----------|
|                                    |               | 10      | 20<br>Madras<br>Softy | 30<br>Hugo<br>Fantasy<br>Illusion<br>Tucson<br>Utah<br>Vintage<br>Wild Laredo<br>Yukon | 40<br>Elegance<br>Princess<br>Santiago<br>Sensation<br>Sunset<br>Trina<br>Victoria | 50<br>Bull<br>Cassiope<br>Dublin | 60<br>Caress<br>Ultrasued | A      | B<br>COM | C<br>alta |
| 001 CHAIR                          | 45x40x30/39   | 1805    | 1910                  | 2015   | 2120   | 2225                             | 2330                      | 1445   | 1495     | 1545      |
| 002 LOVESEAT                       | 68x40x30/39   | 2590    | 2690                  | 2790   | 2890   | 2990                             | 3090                      | 2045   | 2110     | 2175      |
| 003 SOFA                           | 92x40x30/39   | 3100    | 3250                  | 3400   | 3550   | 3700                             | 3850                      | 2450   | 2530     | 2610      |
| 005 LOUNGE CHAIR RIGHT ARM         | 35x62x30/39   | 1635    | 1710                  | 1785   | 1860   | 1935                             | 2010                      | 1295   | 1350     | 1405      |
| 009 ARMLESS LOVESEAT               | 47x40x30/39   | 1790    | 1860                  | 1930   | 2000   | 2070                             | 2140                      | 1390   | 1475     | 1560      |
| 011 LOUNGE CHAIR LEFT ARM          | 35x62x30/39   | 1635    | 1710                  | 1785   | 1860   | 1935                             | 2010                      | 1295   | 1350     | 1405      |
| 012 LOVESEAT LEFT ARM              | 58x40x30/39   | 2180    | 2290                  | 2400   | 2510   | 2620                             | 2730                      | 1725   | 1795     | 1865      |
| 017 DOUBLE CHAIR                   | 52x40x30/39   | 1920    | 2025                  | 2130   | 2235   | 2340                             | 2445                      | 1500   | 1570     | 1640      |
| 021 APARTMENT SOFA NO ARM          | 61x40x30/39   | 2045    | 2135                  | 2225   | 2315   | 2405                             | 2495                      | 1580   | 1660     | 1740      |
| 040 ARMLESS SOFA                   | 71x40x30/39   | 2305    | 2410                  | 2515   | 2620   | 2725                             | 2830                      | 1800   | 1895     | 1990      |
| 041 RECLINING CHAIR LEFT ARM       | 35x40x30/39   | 1790    | 1870                  | 1950   | 2030   | 2110                             | 2190                      | 1495   | 1540     | 1585      |
| 042 RECLINING CHAIR RIGHT ARM      | 35x40x30/39   | 1790    | 1870                  | 1950   | 2030   | 2110                             | 2190                      | 1495   | 1540     | 1585      |
| 043 SWIVEL ROCKING RECLINING CHAIR | 30x34x42      | 2150    | 2245                  | 2340   | 2435   | 2530                             | 2625                      | 1790   | 1835     | 1880      |
| 044 RECLINER CHAIR                 | 45x40x30/39   | 2180    | 2270                  | 2360   | 2450   | 2540                             | 2630                      | 1810   | 1855     | 1900      |
| 045 ARMLESS LOVESEAT BUMPER RIGHT  | 68x40x30/39   | 2100    | 2210                  | 2320   | 2430   | 2540                             | 2650                      | 1630   | 1710     | 1790      |
| 051 ARMLESS CHAIR                  | 23,5x40x30/39 | 1015    | 1060                  | 1105   | 1150   | 1195                             | 1240                      | 795    | 855      | 915       |
| 052 SOFA LEFT ARM                  | 82x40x30/39   | 2700    | 2835                  | 2970   | 3105   | 3240                             | 3375                      | 2120   | 2210     | 2300      |
| 053 SOFA RIGHT ARM                 | 82x40x30/39   | 2700    | 2835                  | 2970   | 3105   | 3240                             | 3375                      | 2120   | 2210     | 2300      |
| 055 SQUARE CORNER                  | 44x44x30/39   | 1865    | 1965                  | 2065   | 2165   | 2265                             | 2365                      | 1450   | 1510     | 1570      |
| 056 CHAIR RIGHT ARM                | 35x40x30/39   | 1415    | 1485                  | 1555   | 1625   | 1695                             | 1765                      | 1130   | 1165     | 1200      |
| 057 CHAIR LEFT ARM                 | 35x40x30/39   | 1415    | 1485                  | 1555   | 1625   | 1695                             | 1765                      | 1130   | 1165     | 1200      |
| 061 LOVESEAT RIGHT ARM             | 58x40x30/39   | 2180    | 2290                  | 2400   | 2510   | 2620                             | 2730                      | 1725   | 1795     | 1865      |



## EDGE

Features: Manual adjustable headrest included with all items (2 with square corner). Stitching: Small thread in fabric and large flat thread in leather. Memory foam in seat cushions. Upholstery of top of arm with feathers. Cupholder N/A with this style.

NOTE: 2 recliner seats SEPARATED by a SQUARE CORNER or UPHOLSTERED TABLE cannot be opened at the same time.

OPTIONS - Specify on your order + SKETCH of your config:  
Leg: LG189 metal (Black or Chrome) or LG103 wood (specify colour).  
Table (154): Specify colour of wood table top.  
WITHOUT METAL insert on arm, add \$50/order.  
043 & 163 Chairs: with wood base (specify colour).

\*\*MANUAL RECLINER N/A.\*\* Motorized mechanism included in price of recliner chair items. For Battery Pack add \$160/mechanism.

| Description                            | L x D x H     | Leather |                       |  |  |                                  |                           | Fabric |          |           |
|--|---------------|---------|-----------------------|--|--|----------------------------------|---------------------------|--------|----------|-----------|
|  |               | 10      | 20<br>Madras<br>Softy | 30<br>Hugo<br>Fantasy<br>Illusion<br>Tucson<br>Utah<br>Vintage<br>Wild Laredo<br>Yukon | 40<br>Elegance<br>Princess<br>Santiago<br>Sensation<br>Sunset<br>Trina<br>Victoria | 50<br>Bull<br>Cassiope<br>Dublin | 60<br>Caress<br>Ultrasued | A      | B<br>COM | C<br>alta |
| 071 ARMLESS RECLINING CHAIR            | 23,5x40x30/39 | 1390    | 1460                  | 1530   | 1600   | 1670                             | 1740                      | 1170   | 1225     | 1280      |
| 086 ARMLESS LOVESEAT BUMPER LEFT       | 68x40x30/39   | 2100    | 2210                  | 2320   | 2430   | 2540                             | 2650                      | 1630   | 1710     | 1790      |
| 088 ARMLESS CHAIR BUMPER LEFT          | 45x40x30/39   | 1335    | 1415                  | 1495   | 1575   | 1655                             | 1735                      | 1040   | 1085     | 1130      |
| 089 ARMLESS CHAIR BUMPER RIGHT         | 45x40x30/39   | 1335    | 1415                  | 1495   | 1575   | 1655                             | 1735                      | 1040   | 1085     | 1130      |
| 095 APARTMENT SOFA                     | 82x40x30/39   | 2820    | 2960                  | 3100   | 3240   | 3380                             | 3520                      | 2215   | 2315     | 2415      |
| 096 APARTMENT SOFA LEFT ARM            | 72x40x30/39   | 2440    | 2570                  | 2700   | 2830   | 2960                             | 3090                      | 1895   | 1980     | 2065      |
| 097 APARTMENT SOFA RIGHT ARM           | 72x40x30/39   | 2440    | 2570                  | 2700   | 2830   | 2960                             | 3090                      | 1895   | 1980     | 2065      |
| 124 STORAGE OTTOMAN                    | 30x22x17      | 705     | 730                   | 755  | 780  | 805                              | 830                       | 605    | 615      | 625       |
| 154 UPHOLSTERED ANGULAR TABLE          | 7/34x32.5x19  | 600     | 625                   | 650  | 675  | 700                              | 725                       | 515    | 530      | 545       |
| 163 DBL SWIVEL ROCKING RECLINER CHAIR  | 33 x 34 x 42  | 2200    | 2315                  | 2430   | 2545   | 2660                             | 2775                      | 1795   | 1840     | 1885      |
| 165 DOUBLE RECLINING CHAIR             | 52x40x30/39   | 2280    | 2390                  | 2500   | 2610   | 2720                             | 2830                      | 1875   | 1950     | 2025      |
| 167 APARTMENT SOFA NO ARM BUMPER LEFT  | 82x40x30/39   | 2350    | 2480                  | 2610   | 2740   | 2870                             | 3000                      | 1820   | 1905     | 1990      |
| 168 APARTMENT SOFA NO ARM BUMPER RIGHT | 82x40x30/39   | 2350    | 2480                  | 2610   | 2740   | 2870                             | 3000                      | 1820   | 1905     | 1990      |
| 169 DOUBLE RECLINING CHAIR LEFT ARM    | 42x40x30/39   | 1885    | 1965                  | 2045   | 2125   | 2205                             | 2285                      | 1550   | 1615     | 1680      |
| 170 DOUBLE RECLINING CHAIR RIGHT ARM   | 42x40x30/39   | 1885    | 1965                  | 2045   | 2125   | 2205                             | 2285                      | 1550   | 1615     | 1680      |
| 171 ARMLESS DOUBLE RECLINING CHAIR     | 30,5x40x30/39 | 1500    | 1550                  | 1600   | 1650   | 1700                             | 1750                      | 1235   | 1305     | 1375      |
| 173 DOUBLE LOUNGE CHAIR LEFT ARM       | 42x62x30/39   | 1790    | 1885                  | 1980   | 2075   | 2170                             | 2265                      | 1395   | 1485     | 1575      |
| 174 DOUBLE LOUNGE CHAIR RIGHT ARM      | 42x62x30/39   | 1790    | 1885                  | 1980   | 2075   | 2170                             | 2265                      | 1395   | 1485     | 1575      |
| 175 DOUBLE CHAIR LEFT ARM              | 42x40x30/39   | 1520    | 1600                  | 1680   | 1760   | 1840                             | 1920                      | 1175   | 1250     | 1325      |
| 176 DOUBLE CHAIR RIGHT ARM             | 42x40x30/39   | 1520    | 1600                  | 1680   | 1760   | 1840                             | 1920                      | 1175   | 1250     | 1325      |
| 177 ARMLESS DOUBLE CHAIR               | 30,5x40x30/39 | 1125    | 1185                  | 1245   | 1305   | 1365                             | 1425                      | 875    | 940      | 1005      |
| 178 ARMLESS DOUBLE CHAIR BUMPER LEFT   | 52x40x30/39   | 1455    | 1540                  | 1625   | 1710   | 1795                             | 1880                      | 1130   | 1180     | 1230      |
| 179 ARMLESS DOUBLE CHAIR BUMPER RIGHT  | 52x40x30/39   | 1455    | 1540                  | 1625   | 1710   | 1795                             | 1880                      | 1130   | 1180     | 1230      |

## CDN Price List

### EDGE

| Description                | L x D x H     | Leather |                       |  |  |                                  |                           | Fabric |          |           |
|----------------------------|---------------|---------|-----------------------|--|--|----------------------------------|---------------------------|--------|----------|-----------|
|                            |               | 10      | 20<br>Madras<br>Softy | 30<br>Hugo<br>Fantasy<br>Illusion<br>Tucson<br>Utah<br>Vintage<br>Wild Laredo<br>Yukon | 40<br>Elegance<br>Princess<br>Santiago<br>Sensation<br>Sunset<br>Trina<br>Victoria | 50<br>Bull<br>Cassiope<br>Dublin | 60<br>Caress<br>Ultrasued | A      | B<br>COM | C<br>alta |
| <b>CONFIGURATIONS</b>      |               |         |                       |  |  |                                  |                           |        |          |           |
| A CONFIG (169-170)         | 84X40X30/39   | 3770    | 3930                  | 4090   | 4250   | 4410                             | 4570                      | 3100   | 3230     | 3360      |
| B CONFIG (169-171-174)     | 115X62X30/39  | 5175    | 5400                  | 5625   | 5850   | 6075                             | 6300                      | 4180   | 4405     | 4630      |
| C CONFIG (096-055-171-170) | 116X117X30/39 | 7690    | 8050                  | 8410   | 8770   | 9130                             | 9490                      | 6130   | 6410     | 6690      |
| D CONFIG (169-171-055-179) | 117X96X30/39  | 6705    | 7020                  | 7335   | 7650   | 7965                             | 8280                      | 5365   | 5610     | 5855      |
| J CONFIG (041-042)         | 70X40X30/39   | 3580    | 3740                  | 3900   | 4060   | 4220                             | 4380                      | 2990   | 3080     | 3170      |
| K CONFIG (041-071-005)     | 94X62X30/39   | 4815    | 5040                  | 5265   | 5490   | 5715                             | 5940                      | 3960   | 4115     | 4270      |
| L CONFIG (012-055-071-042) | 102X103X30/39 | 7225    | 7585                  | 7945   | 8305   | 8665                             | 9025                      | 5840   | 6070     | 6300      |
| M CONFIG (041-071-055-089) | 103X89X30/39  | 6380    | 6710                  | 7040   | 7370   | 7700                             | 8030                      | 5155   | 5360     | 5565      |

# SPECIFICATIONS



## EDGE

LINEA 30 Collection



Conçu et fabriqué fièrement au Canada  
Proudly designed and made in Canada

Nos produits sont fabriqués à la main et des variations mineures peuvent survenir

Our product is hand-made and minor variations can occur.

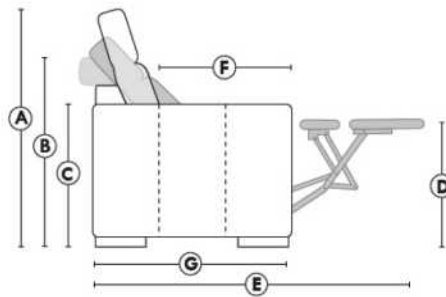

□ Appui-tête levé Headrest up    ■ Appui-tête baissé Headrest down    ■ Complètement incliné Fully reclined

- (A) Hauteur complète 39" Total Height
- (B) Hauteur appui-tête baissé 30" Height headrest down
- (C) Hauteur du bras 24" Arm Height
- (D) Hauteur du siège 19,5" Seat height
- (E) Profondeur inclinée 63" Depth fully reclined
- (F) Profondeur d'assise 20" Seat depth
- (G) Profondeur appui-tête monté 37,5" Depth with headrest up

### BRAS | ARMS

Controleur de l'inclinaison situé à l'intérieur du bras  
Recliner control located on the inside of the arm.

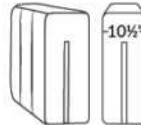

### FAUTEUIL BERÇANT PIVOTANT INCLINABLE SWIVEL ROCKING MOTION CHAIR

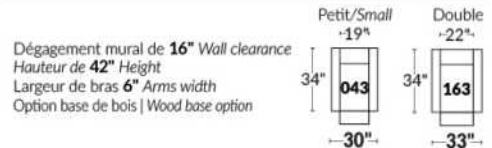

### SIÈGE 23" DE LARGE | 23" SEAT WIDTH

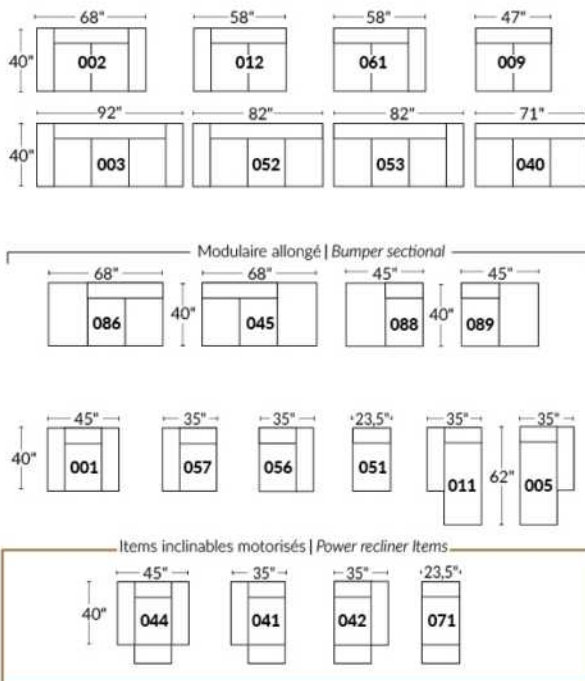

### SIÈGE 30" DE LARGE | 30" SEAT WIDTH

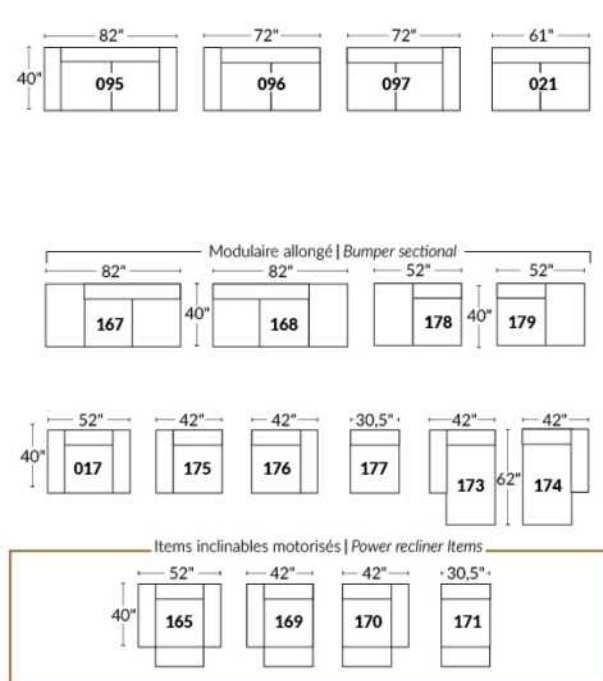

### Autres | Others

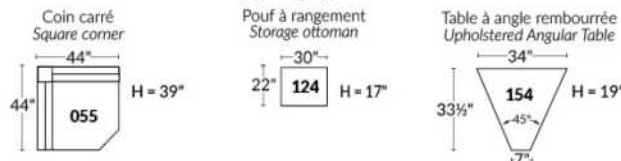

### EXEMPLE 23" EXAMPLE

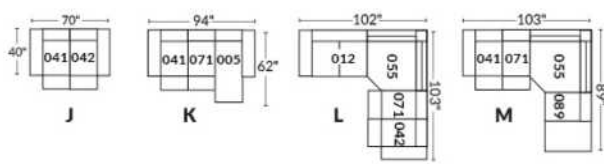

### EXEMPLE 30" EXAMPLE

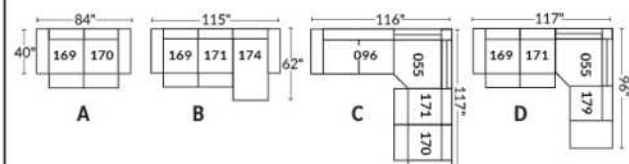

## CDN Price List

### ERICA

Specify colour of legs LG6.

In fabric horizontal band and puller are not part of the design.

| Description  | L x D x H    | Leather |                       |  |  |                                  |                           | Fabric |          |           |
|--------------|--------------|---------|-----------------------|--|--|----------------------------------|---------------------------|--------|----------|-----------|
|              |              | 10      | 20<br>Madras<br>Softy | 30<br>Hugo<br>Fantasy<br>Illusion<br>Tucson<br>Utah<br>Vintage<br>Wild Laredo<br>Yukon | 40<br>Elegance<br>Princess<br>Santiago<br>Sensation<br>Sunset<br>Trina<br>Victoria | 50<br>Bull<br>Cassiope<br>Dublin | 60<br>Caress<br>Ultrasued | A      | B<br>COM | C<br>alta |
| 001 CHAIR    | 42X37X37     | 1605    | 1700                  | 1795   | 1890   | 1985                             | 2080                      | 1100   | 1145     | 1190      |
| 002 LOVESEAT | 66X37X37     | 2290    | 2410                  | 2530   | 2650   | 2770                             | 2890                      | 1510   | 1590     | 1670      |
| 003 SOFA     | 89X37X37     | 2495    | 2655                  | 2815   | 2975   | 3135                             | 3295                      | 1750   | 1835     | 1920      |
| 006 OTTOMAN  | 25.5X25.5X18 | 685     | 710                   | 735  | 760  | 785                              | 810                       | 550    | 570      | 590       |



# ERICA



Hauteur de siège 20" | Hauteur devant bras 26" | Profondeur d'assise 21"  
Seat Height 20" | Arm Height 26" | Seat Depth 21"

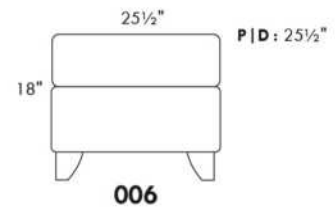
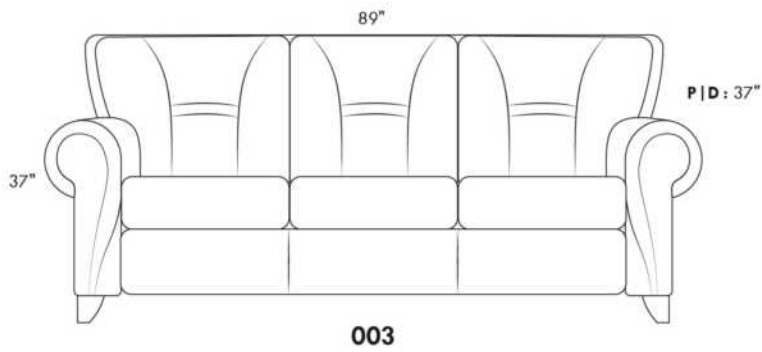
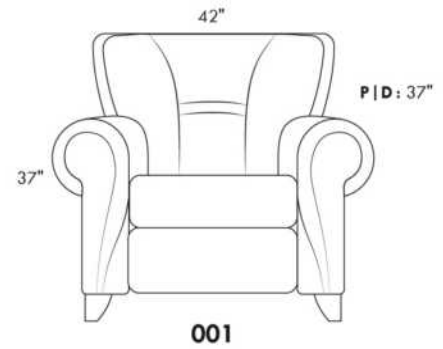
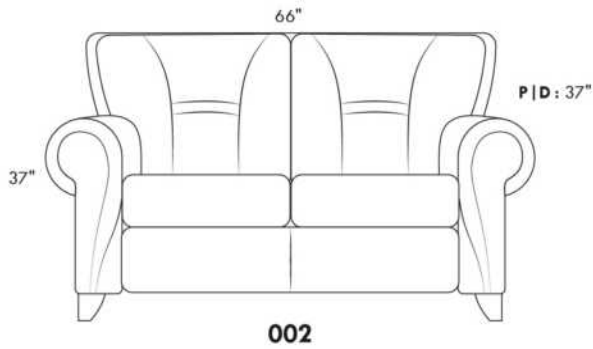

[www.jaymar.ca](http://www.jaymar.ca)

Toutes les dimensions indiquées sont au pouce près. Nos produits sont fabriqués à la main et des variations mineures peuvent survenir.  
All dimensions indicated are to the nearest inch. Our product is hand-made and minor variations can occur.

## EXPO

FEATURES: Upholstered seat cushions with high quality 2.5 lb. density shaped foam and a 1" layer of memory foam.

Recommended in PLAIN FABRIC only.

Item 077 Upholstered Table: Specify colour of table bottom in wood.

N.B.: ARMLESS END pieces (items 216 & 220 ONLY) are upholstered in leather or fabric.

| Description                           | L x D x H      | Leather |                       |  |  |                                  |                           | Fabric |          |           |
|---------------------------------------|----------------|---------|-----------------------|--|--|----------------------------------|---------------------------|--------|----------|-----------|
|                                       |                | 10      | 20<br>Madras<br>Softy | 30<br>Hugo<br>Fantasy<br>Illusion<br>Tucson<br>Utah<br>Vintage<br>Wild Laredo<br>Yukon | 40<br>Elegance<br>Princess<br>Santiago<br>Sensation<br>Sunset<br>Trina<br>Victoria | 50<br>Bull<br>Cassiope<br>Dublin | 60<br>Caress<br>Ultrasued | A      | B<br>COM | C<br>alta |
| 002 LOVESEAT                          | 73x40x34       | 2460    | 2600                  | 2740   | 2880   | 3020                             | 3160                      | 1610   | 1710     | 1810      |
| 005 LOUNGE CHAIR RIGHT ARM            | 37x70x34       | 1990    | 2125                  | 2260   | 2395   | 2530                             | 2665                      | 1320   | 1400     | 1480      |
| 009 ARMLESS LOVESEAT                  | 53x40x34       | 1975    | 2085                  | 2195   | 2305   | 2415                             | 2525                      | 1300   | 1380     | 1460      |
| 011 LOUNGE CHAIR LEFT ARM             | 37x70x34       | 1990    | 2125                  | 2260   | 2395   | 2530                             | 2665                      | 1320   | 1400     | 1480      |
| 012 LOVESEAT LEFT ARM                 | 63x40x34       | 2225    | 2335                  | 2445   | 2555   | 2665                             | 2775                      | 1450   | 1545     | 1640      |
| 050 WEDGE                             | 17/73x40/43x34 | 2400    | 2515                  | 2630   | 2745   | 2860                             | 2975                      | 1570   | 1655     | 1740      |
| 051 ARMLESS CHAIR                     | 27x40x34       | 1100    | 1145                  | 1190   | 1235   | 1280                             | 1325                      | 730    | 755      | 780       |
| 056 CHAIR RIGHT ARM                   | 37x40x34       | 1340    | 1390                  | 1440   | 1490   | 1540                             | 1590                      | 890    | 920      | 950       |
| 057 CHAIR LEFT ARM                    | 37x40x34       | 1340    | 1390                  | 1440   | 1490   | 1540                             | 1590                      | 890    | 920      | 950       |
| 061 LOVESEAT RIGHT ARM                | 63x40x34       | 2225    | 2335                  | 2445   | 2555   | 2665                             | 2775                      | 1450   | 1545     | 1640      |
| 077 UPHOLSTERED TABLE                 | 43.5x15.5x18   | 650     | 700                   | 750  | 800  | 850                              | 900                       | 440    | 460      | 480       |
| 208 CIRCULAR CHAIR RIGHT ARM          | 55X39/43X34    | 1650    | 1740                  | 1830   | 1920   | 2010                             | 2100                      | 1090   | 1140     | 1190      |
| 209 CIRCULAR CHAIR LEFT ARM           | 55X39/43X34    | 1650    | 1740                  | 1830   | 1920   | 2010                             | 2100                      | 1090   | 1140     | 1190      |
| 212 CIRCULAR APARTMENT SOFA RIGHT ARM | 96X39/51X34    | 2870    | 3045                  | 3220   | 3395   | 3570                             | 3745                      | 1870   | 1990     | 2110      |
| 213 CIRCULAR APARTMENT SOFA LEFT ARM  | 96X39/51X34    | 2870    | 3045                  | 3220   | 3395   | 3570                             | 3745                      | 1870   | 1990     | 2110      |
| 214 CIRCULAR APARTMENT SOFA           | 105X39/51X34   | 3115    | 3325                  | 3535   | 3745   | 3955                             | 4165                      | 2010   | 2120     | 2230      |
| 216 CIRCULAR APARTMENT SOFA NO ARM    | 88X39/47X34    | 2655    | 2800                  | 2945   | 3090   | 3235                             | 3380                      | 1740   | 1825     | 1910      |
| 220 CIRCULAR CHAIR NO ARM             | 46X39/43X34    | 1405    | 1485                  | 1565   | 1645   | 1725                             | 1805                      | 965    | 1030     | 1095      |
| <b>CONFIGURATIONS</b>                 |                |         |                       |  |  |                                  |                           |        |          |           |
| A CONFIG. (213-216-212)               | 177X99.5X34    | 8395    | 8890                  | 9385   | 9880   | 10375                            | 10870                     | 5480   | 5805     | 6130      |
| B CONFIG. (213-220-212)               | 175X86X34      | 7145    | 7575                  | 8005   | 8435   | 8865                             | 9295                      | 4705   | 5010     | 5315      |
| C CONFIG. (213-212)                   | 162.5X72.5X34  | 5740    | 6090                  | 6440   | 6790   | 7140                             | 7490                      | 3740   | 3980     | 4220      |
| D CONFIG. (209-220-208)               | 140X60.5X34    | 4705    | 4965                  | 5225   | 5485   | 5745                             | 6005                      | 3145   | 3310     | 3475      |
| E CONFIG. (216-216-216)               | 177X88.5X34    | 7965    | 8400                  | 8835   | 9270   | 9705                             | 10140                     | 5220   | 5475     | 5730      |
| F CONFIG. (216-220-216)               | 171X75X34      | 6715    | 7085                  | 7455   | 7825   | 8195                             | 8565                      | 4445   | 4680     | 4915      |
| G CONFIG. (220-220-220)               | 125.5X53X34    | 4215    | 4455                  | 4695   | 4935   | 5175                             | 5415                      | 2895   | 3090     | 3285      |

## CDN Price List

### EXPO

| Description                     | L x D x H  | Leather |                       |  |  |                                  |                           | Fabric |          |           |
|---------------------------------|------------|---------|-----------------------|--|--|----------------------------------|---------------------------|--------|----------|-----------|
|                                 |            | 10      | 20<br>Madras<br>Softy | 30<br>Hugo<br>Fantasy<br>Illusion<br>Tucson<br>Utah<br>Vintage<br>Wild Laredo<br>Yukon | 40<br>Elegance<br>Princess<br>Santiago<br>Sensation<br>Sunset<br>Trina<br>Victoria | 50<br>Bull<br>Cassiope<br>Dublin | 60<br>Caress<br>Ultrasued | A      | B<br>COM | C<br>alta |
| H CONFIG. (012-050-009-005)     | 133X106X34 | 8590    | 9060                  | 9530   | 10000  | 10470                            | 10940                     | 5640   | 5980     | 6320      |
| I CONFIG. (011-051-050-061)     | 107X106X34 | 7715    | 8120                  | 8525   | 8930   | 9335                             | 9740                      | 5070   | 5355     | 5640      |
| J CONFIG. (011-051-050-051-005) | 107X107X34 | 8580    | 9055                  | 9530   | 10005  | 10480                            | 10955                     | 5670   | 5965     | 6260      |
| K CONFIG. (012-050-061)         | 106X106X34 | 6850    | 7185                  | 7520   | 7855   | 8190                             | 8525                      | 4470   | 4745     | 5020      |

Hauteur complète 34" | Hauteur de siège 17¼" | Hauteur devant bras 24" | Profondeur d'assise 23"  
 Total Height 34" | Seat Height 17¼" | Arm Height 24" | Seat Depth 23"

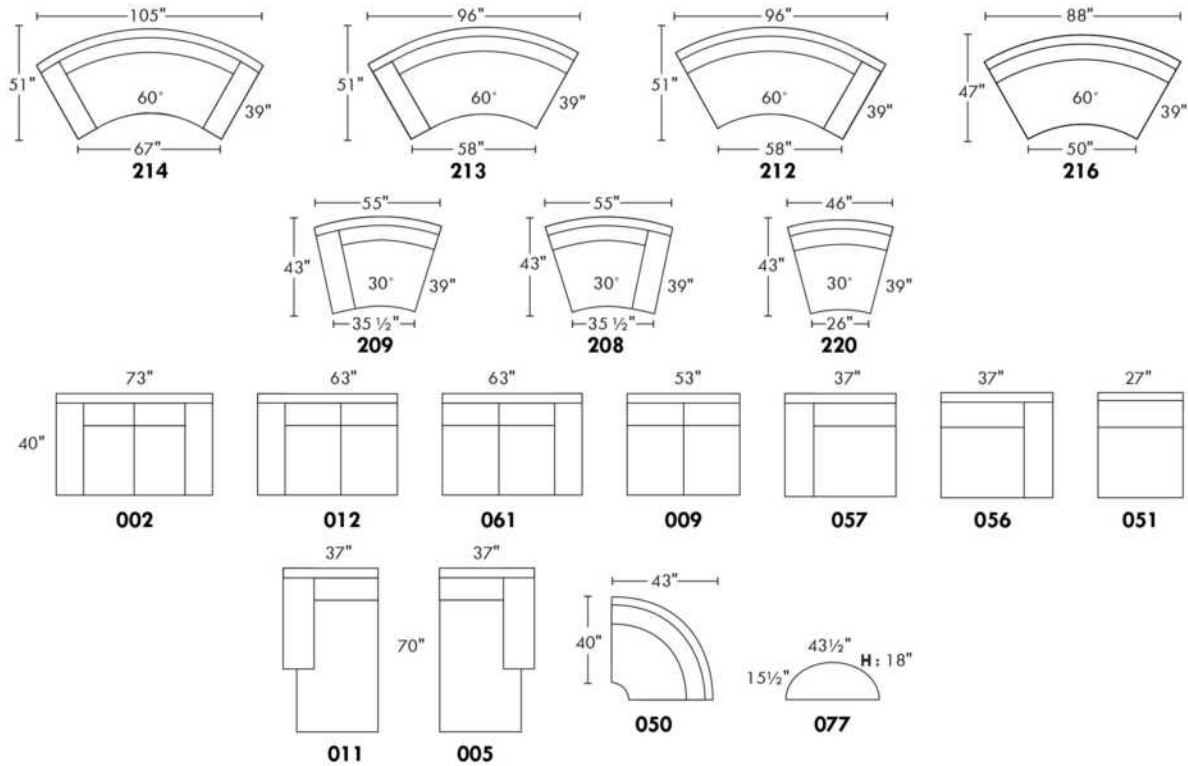

## CONFIGURATIONS

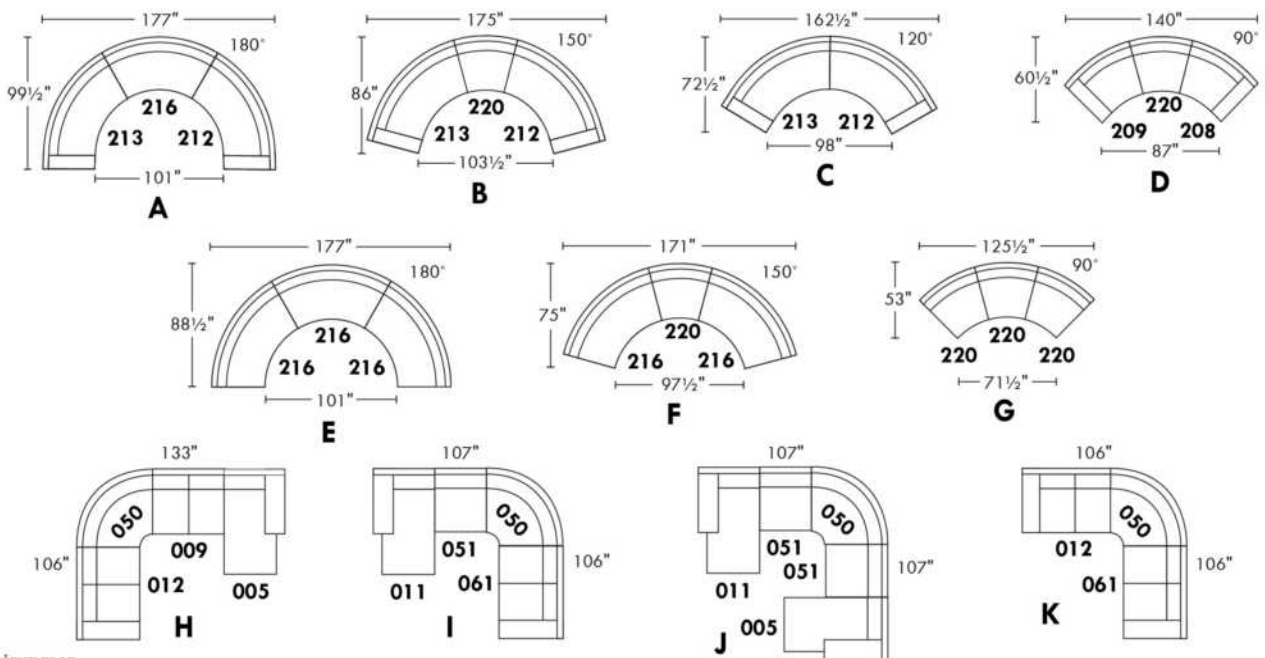

www.jaymar.ca

Toutes les dimensions indiquées sont au pouce près. Nos produits sont fabriqués à la main et des variations mineures peuvent survenir.  
 All dimensions indicated are to the nearest inch. Our product is hand-made and minor variations can occur.

## FELIX

LEG: Specify colour of legs LG171 (round) or LG8 (square).

In FABRIC there is NO DECORATIVE STITCHING on back cushions. COMBO: Cover #2 on back only.

1x Removable headrest included with motion skus 044, 041, 042 & 071. EXTRA headrest on non motion back: add \$125/ headrest.

Specify REGULAR seating 21" or DEEP seating 22". The following ITEMS are NOT AVAILABLE in DEEP SEATING: 018, 023, 046, 050, 055, 062, 063 & ALL MOTION items 044, 041, 042 & 071.

OPTIONS:

UPHOLSTERY of seat cushions WITH FEATHERS: Add \$60 per seat. \*Bumper counts as 1 seat, skus 005-011-062 & 063 count as 2 seats each.

NAILS on arms only: Add \$35 per arm.

Sofa bed MATTRESS: Regular 4" thick mattress included. OPTIONAL mattresses:

- 4,5" thick mattress with coils and memory foam with gel: add \$100 or

- 5" thick mattress with high density foam and memory foam with gel: add \$150.

Motorized reclining mechanism with TOUCH-SENSOR button add \$160/ mechanism. For WIRELESS (Battery) motorized reclining mechanism add \$320.

N.B.: 2 reclining seats SEPARATED BY a WEDGE or SQUARE CORNER cannot be opened at the same time.

| Description                       | L x D x H    | Leather |                       |  |  |                                  |                           | Fabric |          |           |
|-----------------------------------|--------------|---------|-----------------------|--|--|----------------------------------|---------------------------|--------|----------|-----------|
|                                   |              | 10      | 20<br>Madras<br>Softy | 30<br>Hugo<br>Fantasy<br>Illusion<br>Tucson<br>Utah<br>Vintage<br>Wild Laredo<br>Yukon | 40<br>Elegance<br>Princess<br>Santiago<br>Sensation<br>Sunset<br>Trina<br>Victoria | 50<br>Bull<br>Cassiope<br>Dublin | 60<br>Caress<br>Ultrasued | A      | B<br>COM | C<br>alta |
| 001 CHAIR                         | 43X37X35     | 1390    | 1485                  | 1580   | 1675   | 1770                             | 1865                      | 995    | 1040     | 1085      |
| 002 LOVESEAT                      | 66X37X35     | 1990    | 2125                  | 2260   | 2395   | 2530                             | 2665                      | 1360   | 1435     | 1510      |
| 003 SOFA                          | 89X37X35     | 2465    | 2635                  | 2805   | 2975   | 3145                             | 3315                      | 1750   | 1845     | 1940      |
| 005 LOUNGE CHAIR RIGHT ARM        | 33X61X35     | 1630    | 1740                  | 1850   | 1960   | 2070                             | 2180                      | 1145   | 1225     | 1305      |
| 006 OTTOMAN                       | 25.5X25.5X19 | 630     | 685                   | 740  | 795  | 850                              | 905                       | 535    | 545      | 555       |
| 009 ARMLESS LOVESEAT              | 46X37X35     | 1545    | 1655                  | 1765   | 1875   | 1985                             | 2095                      | 1130   | 1195     | 1260      |
| 011 LOUNGE CHAIR LEFT ARM         | 33X61X35     | 1630    | 1740                  | 1850   | 1960   | 2070                             | 2180                      | 1145   | 1225     | 1305      |
| 012 LOVESEAT LEFT ARM             | 56X37X35     | 1765    | 1880                  | 1995   | 2110   | 2225                             | 2340                      | 1230   | 1315     | 1400      |
| 018 ANGULAR LOVESEAT LEFT ARM     | 70X51X35     | 1875    | 2005                  | 2135   | 2265   | 2395                             | 2525                      | 1335   | 1405     | 1475      |
| 023 ANGULAR LOVESEAT RIGHT ARM    | 70X51X35     | 1875    | 2005                  | 2135   | 2265   | 2395                             | 2525                      | 1335   | 1405     | 1475      |
| 040 ARMLESS SOFA                  | 69X37X35     | 2040    | 2185                  | 2330   | 2475   | 2620                             | 2765                      | 1495   | 1600     | 1705      |
| 041 RECLINING CHAIR LEFT ARM      | 33X37X43     | 1580    | 1660                  | 1740   | 1820   | 1900                             | 1980                      | 1300   | 1360     | 1420      |
| 042 RECLINING CHAIR RIGHT ARM     | 33X37X43     | 1580    | 1660                  | 1740   | 1820   | 1900                             | 1980                      | 1300   | 1360     | 1420      |
| 044 RECLINER CHAIR                | 43X37X43     | 1800    | 1900                  | 2000   | 2100   | 2200                             | 2300                      | 1395   | 1475     | 1555      |
| 045 ARMLESS LOVESEAT BUMPER RIGHT | 66X37X35     | 1795    | 1930                  | 2065   | 2200   | 2335                             | 2470                      | 1255   | 1330     | 1405      |
| 046 ARMLESS ANGULAR LOVESEAT      | 60X51X35     | 1690    | 1805                  | 1920   | 2035   | 2150                             | 2265                      | 1210   | 1295     | 1380      |
| 050 WEDGE                         | 48X48X35     | 1460    | 1545                  | 1630   | 1715   | 1800                             | 1885                      | 1125   | 1170     | 1215      |
| 051 ARMLESS CHAIR                 | 23X37X35     | 945     | 1005                  | 1065   | 1125   | 1185                             | 1245                      | 765    | 815      | 865       |
| 052 SOFA LEFT ARM                 | 79X37X35     | 2240    | 2405                  | 2570   | 2735   | 2900                             | 3065                      | 1620   | 1720     | 1820      |
| 053 SOFA RIGHT ARM                | 79X37X35     | 2240    | 2405                  | 2570   | 2735   | 2900                             | 3065                      | 1620   | 1720     | 1820      |
| 055 SQUARE CORNER                 | 37X37X35     | 1400    | 1485                  | 1570   | 1655   | 1740                             | 1825                      | 1055   | 1125     | 1195      |

## FELIX

LEG: Specify colour of legs LG171 (round) or LG8 (square).

In FABRIC there is NO DECORATIVE STITCHING on back cushions. COMBO: Cover #2 on back only.

1x Removable headrest included with motion skus 044, 041, 042 & 071. EXTRA headrest on non motion back: add \$125/ headrest.

Specify REGULAR seating 21" or DEEP seating 22". The following ITEMS are NOT AVAILABLE in DEEP SEATING: 018, 023, 046, 050, 055, 062, 063 & ALL MOTION items 044, 041, 042 & 071.

OPTIONS:

UPHOLSTERY of seat cushions WITH FEATHERS: Add \$60 per seat. \*Bumper counts as 1 seat, skus 005-011-062 & 063 count as 2 seats each.

NAILS on arms only: Add \$35 per arm.

Sofa bed MATTRESS: Regular 4" thick mattress included. OPTIONAL mattresses:

- 4,5" thick mattress with coils and memory foam with gel: add \$100 or

- 5" thick mattress with high density foam and memory foam with gel: add \$150.

Motorized reclining mechanism with TOUCH-SENSOR button add \$160/ mechanism. For WIRELESS (Battery) motorized reclining mechanism add \$320.

N.B.: 2 reclining seats SEPARATED BY a WEDGE or SQUARE CORNER cannot be opened at the same time.

| Description                      | L x D x H  | Leather |                       |  |  |                                  |                           | Fabric |          |           |
|----------------------------------|------------|---------|-----------------------|--|--|----------------------------------|---------------------------|--------|----------|-----------|
|                                  |            | 10      | 20<br>Madras<br>Softy | 30<br>Hugo<br>Fantasy<br>Illusion<br>Tucson<br>Utah<br>Vintage<br>Wild Laredo<br>Yukon | 40<br>Elegance<br>Princess<br>Santiago<br>Sensation<br>Sunset<br>Trina<br>Victoria | 50<br>Bull<br>Cassiope<br>Dublin | 60<br>Caress<br>Ultrasued | A      | B<br>COM | C<br>alta |
| 056 CHAIR RIGHT ARM              | 33X37X35   | 1155    | 1260                  | 1365   | 1470   | 1575                             | 1680                      | 890    | 940      | 990       |
| 057 CHAIR LEFT ARM               | 33X37X35   | 1155    | 1260                  | 1365   | 1470   | 1575                             | 1680                      | 890    | 940      | 990       |
| 060 QUEEN SOFA BED               | 89X37X35   | 2855    | 3025                  | 3195   | 3365   | 3535                             | 3705                      | 2130   | 2240     | 2350      |
| 061 LOVESEAT RIGHT ARM           | 56X37X35   | 1765    | 1880                  | 1995   | 2110   | 2225                             | 2340                      | 1230   | 1315     | 1400      |
| 062 ANGLE CHAIR LEFT ARM         | 70X65X35   | 1690    | 1780                  | 1870   | 1960   | 2050                             | 2140                      | 1180   | 1270     | 1360      |
| 063 ANGLE CHAIR RIGHT ARM        | 70X65X35   | 1690    | 1780                  | 1870   | 1960   | 2050                             | 2140                      | 1180   | 1270     | 1360      |
| 071 ARMLESS RECLINING CHAIR      | 23X37X43   | 1345    | 1410                  | 1475   | 1540   | 1605                             | 1670                      | 1175   | 1225     | 1275      |
| 072 SECTIONAL SOFA LEFT ARM      | 92.5X37X35 | 2650    | 2805                  | 2960   | 3115   | 3270                             | 3425                      | 1870   | 1975     | 2080      |
| 073 SECTIONAL SOFA RIGHT ARM     | 92.5X37X35 | 2650    | 2805                  | 2960   | 3115   | 3270                             | 3425                      | 1870   | 1975     | 2080      |
| 079 QUEEN SOFA BED NO ARM        | 69X37X35   | 2420    | 2580                  | 2740   | 2900   | 3060                             | 3220                      | 1885   | 1995     | 2105      |
| 080 ANGULAR OTTOMAN              | 36X27X19   | 735     | 760                   | 785  | 810  | 835                              | 860                       | 610    | 620      | 630       |
| 082 QUEEN SOFA BED LEFT ARM      | 79X37X35   | 2615    | 2780                  | 2945   | 3110   | 3275                             | 3440                      | 2020   | 2110     | 2200      |
| 083 QUEEN SOFA BED RIGHT ARM     | 79X37X35   | 2615    | 2780                  | 2945   | 3110   | 3275                             | 3440                      | 2020   | 2110     | 2200      |
| 086 ARMLESS LOVESEAT BUMPER LEFT | 66X37X35   | 1795    | 1930                  | 2065   | 2200   | 2335                             | 2470                      | 1255   | 1330     | 1405      |
| 088 ARMLESS CHAIR BUMPER LEFT    | 43X37X35   | 1185    | 1285                  | 1385   | 1485   | 1585                             | 1685                      | 905    | 970      | 1035      |
| 089 ARMLESS CHAIR BUMPER RIGHT   | 43X37X35   | 1185    | 1285                  | 1385   | 1485   | 1585                             | 1685                      | 905    | 970      | 1035      |
| 306 OTTOMAN WITH LOUNGE CUSHION  | 24X24X19   | 750     | 805                   | 860  | 915  | 970                              | 1025                      | 620    | 645      | 670       |

# FELIX

Hauteur complète 35" | Hauteur de siège 19" | Hauteur devant bras 25" | Profondeur d'assise 21"/22"  
 Total Height 35" | Seat Height 19" | Arm Height 25" | Seat Depth 21"/22"

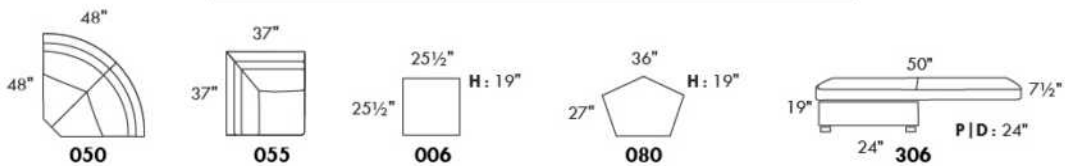
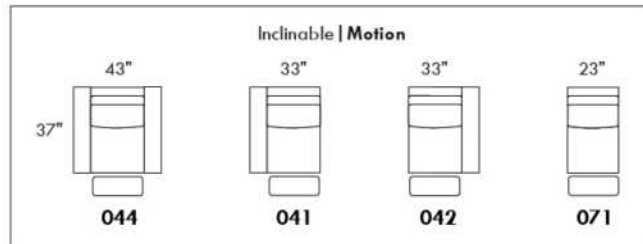
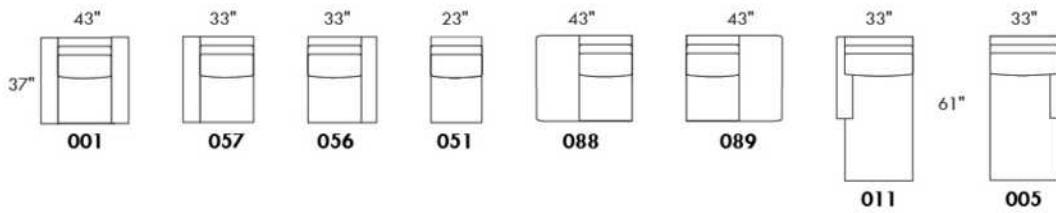
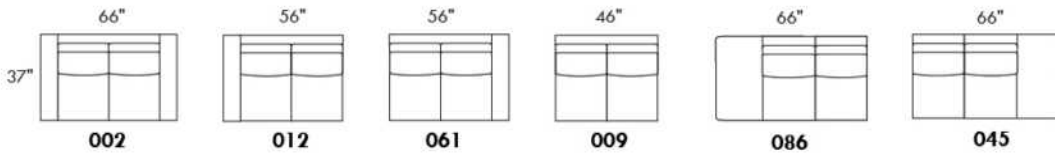
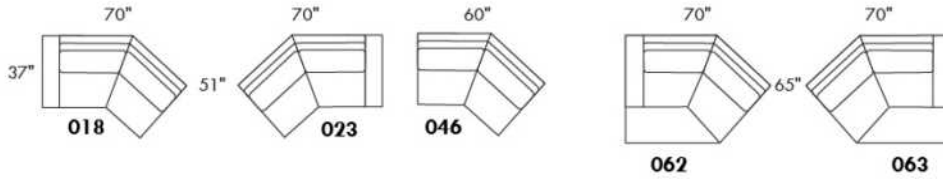
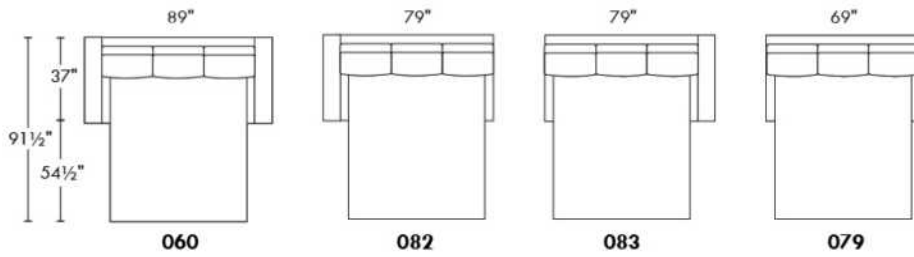
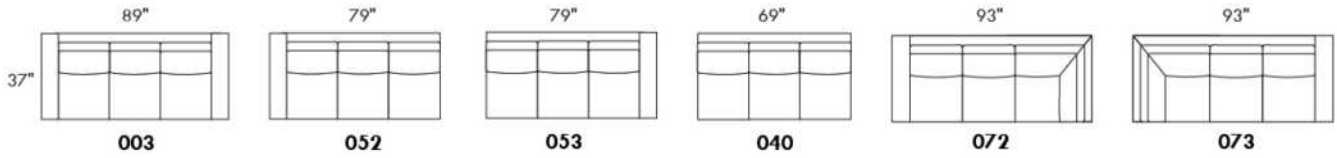

www.jaymar.ca

Toutes les dimensions indiquées sont au pouce près. Nos produits sont fabriqués à la main et des variations mineures peuvent survenir.  
 All dimensions indicated are to the nearest inch. Our product is hand-made and minor variations can occur.

## GLAMOUR

### FEATURES:

- The fashion collection offers unparalleled comfort. Each module is filled with a 100% Canadian feather mix.
- The envelopes are compartmentalized in 100% cotton casings to equally maintain the feathers in the cushions while minimizing feather leaks.
- All furniture pieces are finished on the sides and can be arranged as a sectional or as standalone pieces.
- Each item has a discreet fastening system that can be turned under the furniture.

Items #256 Large Square Ottoman & #257 Upholstered Square Table can be use as a square corner.

ARM CUSHIONS - INCLUDED: Cover will be the same as the fabric choosen for the base only.

### BACK CUSHIONS

The back cushions (large & small) are included in the identified items. (See sketch).

You must choose the style of back cushions either: FASHION I (full width) or FASHION II (square cushion).

Note: You may not combine a Fashion I and II style cushion within the same item.

Ex: You can take a Fashion I cushion for a chair 001 & a Fashion II cushion for a square corner 055.

### Specify on your ORDER:

For each item, specify style (I or II) for the cushions.

You must also specify the cover of the base as well as the cushions.

Ex.: Item 095 base: Cover #1. Cushions Fashion II 833: cover #2 & 834: #3.

Leg: LG201 metal (chrome or black); specify colour.

Upholstered tables items 077, 257 & 258: Specify color of wood table top.

EXTRA Back Cushions: Specify code, cover, color and quantity.

| Description                       | L x D x H   | Leather |                       |  |  |                                  |                           | Fabric |          |           |
|-----------------------------------|-------------|---------|-----------------------|--|--|----------------------------------|---------------------------|--------|----------|-----------|
|                                   |             | 10      | 20<br>Madras<br>Softy | 30<br>Hugo<br>Fantasy<br>Illusion<br>Tucson<br>Utah<br>Vintage<br>Wild Laredo<br>Yukon | 40<br>Elegance<br>Princess<br>Santiago<br>Sensation<br>Sunset<br>Trina<br>Victoria | 50<br>Bull<br>Cassiope<br>Dublin | 60<br>Caress<br>Ultrasued | A      | B<br>COM | C<br>alta |
| 006 OTTOMAN                       | 36x30x18    |         |                       |  |  |                                  |                           | 650    | 670      | 690       |
| 017 DOUBLE CHAIR                  | 57x44x30/35 |         |                       |  |  |                                  |                           | 1340   | 1390     | 1440      |
| 021 APARTMENT SOFA NO ARM         | 71x44x30/35 |         |                       |  |  |                                  |                           | 1750   | 1825     | 1900      |
| 055 SQUARE CORNER                 | 52x52x30/35 |         |                       |  |  |                                  |                           | 1545   | 1595     | 1645      |
| 077 UPHOLSTERED TABLE             | 36x44x16    |         |                       |  |  |                                  |                           | 900    | 925      | 950       |
| 095 APARTMENT SOFA                | 93x44x30/35 |         |                       |  |  |                                  |                           | 1970   | 2050     | 2130      |
| 096 APARTMENT SOFA LEFT ARM       | 82x44x30/35 |         |                       |  |  |                                  |                           | 1855   | 1945     | 2035      |
| 097 APARTMENT SOFA RIGHT ARM      | 82x44x30/35 |         |                       |  |  |                                  |                           | 1855   | 1945     | 2035      |
| 115 LARGE OTTOMAN                 | 36x44x18    |         |                       |  |  |                                  |                           | 785    | 820      | 855       |
| 173 DOUBLE LOUNGE CHAIR LEFT ARM  | 41x78x30/35 |         |                       |  |  |                                  |                           | 1655   | 1710     | 1765      |
| 174 DOUBLE LOUNGE CHAIR RIGHT ARM | 41x78x30/35 |         |                       |  |  |                                  |                           | 1655   | 1710     | 1765      |
| 175 DOUBLE CHAIR LEFT ARM         | 46x44x30/35 |         |                       |  |  |                                  |                           | 1235   | 1285     | 1335      |
| 176 DOUBLE CHAIR RIGHT ARM        | 46x44x30/35 |         |                       |  |  |                                  |                           | 1235   | 1285     | 1335      |
| 177 ARMLESS DOUBLE CHAIR          | 36x44x30/35 |         |                       |  |  |                                  |                           | 1135   | 1165     | 1195      |



## GLAMOUR

### FEATURES:

- The fashion collection offers unparalleled comfort. Each module is filled with a 100% Canadian feather mix.
- The envelopes are compartmentalized in 100% cotton casings to equally maintain the feathers in the cushions while minimizing feather leaks.
- All furniture pieces are finished on the sides and can be arranged as a sectional or as standalone pieces.
- Each item has a discreet fastening system that can be turned under the furniture.

Items #256 Large Square Ottoman & #257 Upholstered Square Table can be use as a square corner.

ARM CUSHIONS - INCLUDED: Cover will be the same as the fabric choosen for the base only.

### BACK CUSHIONS

The back cushions (large & small) are included in the identified items. (See sketch).

You must choose the style of back cushions either: FASHION I (full width) or FASHION II (square cushion).

Note: You may not combine a Fashion I and II style cushion within the same item.

Ex: You can take a Fashion I cushion for a chair 001 & a Fashion II cushion for a square corner 055.

### Specify on your ORDER:

For each item, specify style (I or II) for the cushions.

You must also specify the cover of the base as well as the cushions.

Ex.: Item 095 base: Cover #1. Cushions Fashion II 833: cover #2 & 834: #3.

Leg: LG201 metal (chrome or black); specify colour.

Upholstered tables items 077, 257 & 258: Specify color of wood table top.

EXTRA Back Cushions: Specify code, cover, color and quantity.

| Description                           | L x D x H     | Leather |                       |  |  |                                  |                           | Fabric |          |           |
|---------------------------------------|---------------|---------|-----------------------|--|--|----------------------------------|---------------------------|--------|----------|-----------|
|                                       |               | 10      | 20<br>Madras<br>Softy | 30<br>Hugo<br>Fantasy<br>Illusion<br>Tucson<br>Utah<br>Vintage<br>Wild Laredo<br>Yukon | 40<br>Elegance<br>Princess<br>Santiago<br>Sensation<br>Sunset<br>Trina<br>Victoria | 50<br>Bull<br>Cassiope<br>Dublin | 60<br>Caress<br>Ultrasued | A      | B<br>COM | C<br>alta |
| 178 ARMLESS DOUBLE CHAIR BUMPER LEFT  | 60x44x30/35   |         |                       |  |  |                                  |                           | 1480   | 1525     | 1570      |
| 179 ARMLESS DOUBLE CHAIR BUMPER RIGHT | 60x44x30/35   |         |                       |  |  |                                  |                           | 1480   | 1525     | 1570      |
| 256 LARGE SQUARE OTTOMAN              | 44x44x18      |         |                       |  |  |                                  |                           | 955    | 985      | 1015      |
| 257 UPHOLSTERED SQUARE TABLE          | 44x44x16      |         |                       |  |  |                                  |                           | 1155   | 1185     | 1215      |
| 258 SMALL UPHOLSTERED TABLE           | 15x44x16      |         |                       |  |  |                                  |                           | 600    | 615      | 630       |
| 831 F I: LARGE BACK CUSHION 34X19     | 34x7x19       |         |                       |  |  |                                  |                           | 105    | 105      | 105       |
| 832 F 1: SMALL BACK CUSHION 24X10     | 24x6x10       |         |                       |  |  |                                  |                           | 85     | 85       | 85        |
| 833 F II: LARGE BACK CUSHION 26X19    | 26x7x19       |         |                       |  |  |                                  |                           | 105    | 105      | 105       |
| 834 F II: SMALL BACK CUSHION 16X16    | 16x6x16       |         |                       |  |  |                                  |                           | 85     | 85       | 85        |
| <b>CONFIGURATIONS</b>                 |               |         |                       |  |  |                                  |                           |        |          |           |
| A CONFIG (173-097) + (006)            | 123X78X30/35  |         |                       |  |  |                                  |                           | 4160   | 4325     | 4490      |
| B CONFIG (096-055-176) + (077)        | 98X134X30/35  |         |                       |  |  |                                  |                           | 5535   | 5750     | 5965      |
| C CONFIG (175-115-055-097)            | 134X134X30/35 |         |                       |  |  |                                  |                           | 5420   | 5645     | 5870      |
| D CONFIG (173-177-055-097)            | 129X134X30/35 |         |                       |  |  |                                  |                           | 6190   | 6415     | 6640      |

# GLAMOUR

HAUTEUR COMPLÈTE: 30"/35" | HAUTEUR SIÈGE: 18" | HAUTEUR DEVANT BRAS: 23" | PROFONDEUR D'ASSISE: 23"  
 TOTAL HEIGHT: 30"/35" | SEAT HEIGHT: 18" | ARM HEIGHT: 23" | SEAT DEPTH: 23"

## FASHION COLLECTION

### FASHION I

COUSSINS PLEINE LARGEUR  
 FULL BACK CUSHIONS

831 34 x 7 x 19  
 832 24 x 6 x 10



### FASHION II

COUSSINS CARRÉS - DOS APPARENT  
 SQUARE CUSHIONS - VISIBLE BACK

833 26 x 7 x 19  
 834 16 x 6 x 16

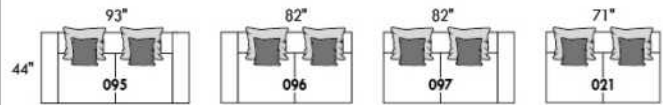
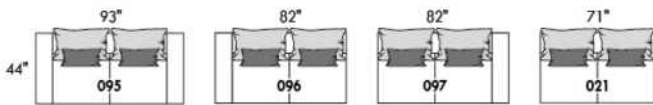

Mélanger & agencer!  
 Mix & Match!

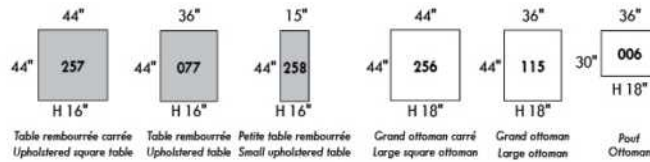
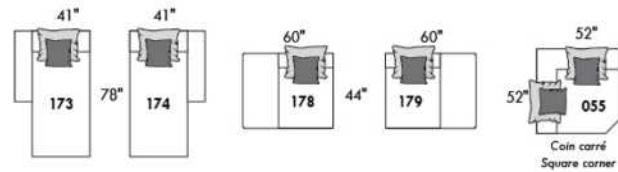
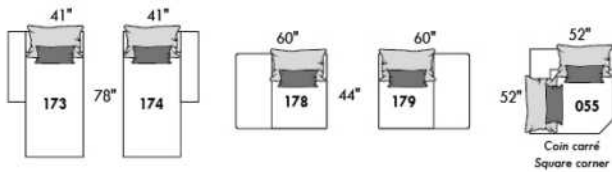
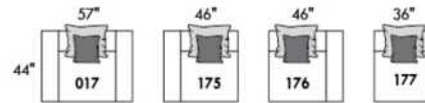
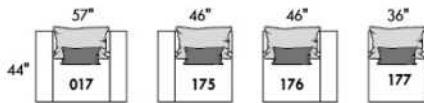

### Populaires | Popular CONFIGURATIONS

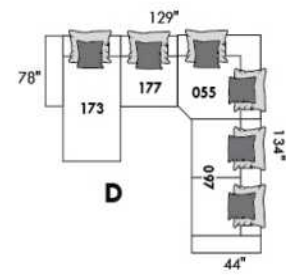
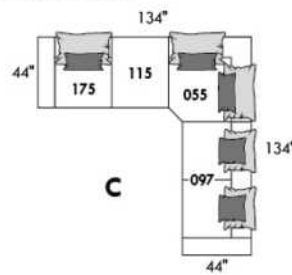
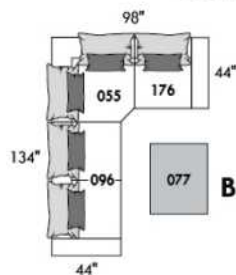
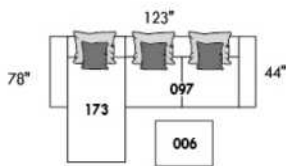

www.jaymar.ca

Toutes les dimensions indiquées sont au pouce près. Nos produits sont fabriqués à la main et des variations mineures peuvent survenir.  
 All dimensions indicated are to the nearest inch. Our product is hand-made and minor variations can occur.



## HAMBOURG

- Manual adjustable headrest on all items (2 on square corner & stationary on wedge).
- \*Wall hugger power recliners with full footrest (manual n/a).
- Power recliner lounge chair (manual n/a) with power headrest in option. Wall clearance 8" & front 5".
- Seat cushions with shaped foam + 1" layer of memory foam on top; arm with memory foam.
- Stitching: Small thread in fabric & large flat thread in leather.

Chairs 043 & 163: arms with NO METAL insert.

\*Excludes 043 & 163 chairs: Wall clearance 16"

Note: 2 recliner seats separated by a corner can not be opened at the same time. No recliner seats beside item #155.

### OPTIONS

- Battery Pack: Add \$160/ea.
- \*Motorized headrest: Add \$160 ea. (\*N/A on stationary items).
- Foam: Extra firm add \$15/seat.
- Choice of arms: (Large or the Small 6" Arm which will have no metal insert in arm): Leg on LARGE arm: LG103 wood, Metal: LG189 cyl. (Black or Chrome). SMALL Arm: LG08 wood, Metal: LG196 cyl. (Black or Chrome) or LG64 (sq). Specify colour.
- Seat Depth: 20" or \*22". \*22" seat depth N/A on chairs 043 & 163.
- 043 & 163 Chairs: with wood base (specify colour).

### HOME THEATRE Configurations

For Accessories, Cup holders & Configuration details, see Optima Home Theatre page attached.

Accessory Dock : \$35 ea.

Cup Holders: Metal: \$25 ea. | LED lighted Cup Holder: \$25 ea. | \*LED lighted Cup Holder with (1 or 2 motor) controls: \$40 ea.

\*LED Light strip under seat: \$25/seat.

| Description                        | L x D x H   | Leather |                       |  |  |                                  |                            | Fabric |          |           |
|------------------------------------|-------------|---------|-----------------------|--|--|----------------------------------|----------------------------|--------|----------|-----------|
|                                    |             | 10      | 20<br>Madras<br>Softy | 30<br>Hugo<br>Fantasy<br>Illusion<br>Tucson<br>Utah<br>Vintage<br>Wild Laredo<br>Yukon | 40<br>Elegance<br>Princess<br>Santiago<br>Sensation<br>Sunset<br>Trina<br>Victoria | 50<br>Bull<br>Cassiope<br>Dublin | 60<br>Caresse<br>Ultrasued | A      | B<br>COM | C<br>alta |
| 001 CHAIR                          | 44x40x33/40 | 1890    | 1980                  | 2070   | 2160   | 2250                             | 2340                       | 1535   | 1580     | 1625      |
| 002 LOVESEAT                       | 67x40x33/40 | 2700    | 2815                  | 2930   | 3045   | 3160                             | 3275                       | 2175   | 2250     | 2325      |
| 003 SOFA                           | 91x40x33/40 | 3265    | 3415                  | 3565   | 3715   | 3865                             | 4015                       | 2625   | 2715     | 2805      |
| 005 LOUNGE CHAIR RIGHT ARM         | 34x62x33/40 | 1765    | 1830                  | 1895   | 1960   | 2025                             | 2090                       | 1410   | 1470     | 1530      |
| 009 ARMLESS LOVESEAT               | 47x40x33/40 | 1895    | 1965                  | 2035   | 2105   | 2175                             | 2245                       | 1490   | 1570     | 1650      |
| 011 LOUNGE CHAIR LEFT ARM          | 34x62x33/40 | 1765    | 1830                  | 1895   | 1960   | 2025                             | 2090                       | 1410   | 1470     | 1530      |
| 012 LOVESEAT LEFT ARM              | 57x40x33/40 | 2320    | 2420                  | 2520   | 2620   | 2720                             | 2820                       | 1850   | 1925     | 2000      |
| 017 DOUBLE CHAIR                   | 51x40x33/40 | 1980    | 2080                  | 2180   | 2280   | 2380                             | 2480                       | 1600   | 1660     | 1720      |
| 021 APARTMENT SOFA NO ARM          | 61x40x33/40 | 2140    | 2240                  | 2340   | 2440   | 2540                             | 2640                       | 1670   | 1755     | 1840      |
| 040 ARMLESS SOFA                   | 71x40x33/40 | 2450    | 2565                  | 2680   | 2795   | 2910                             | 3025                       | 1950   | 2040     | 2130      |
| 041 RECLINING CHAIR LEFT ARM       | 34x40x33/40 | 1885    | 1960                  | 2035   | 2110   | 2185                             | 2260                       | 1605   | 1640     | 1675      |
| 042 RECLINING CHAIR RIGHT ARM      | 34x40x33/40 | 1885    | 1960                  | 2035   | 2110   | 2185                             | 2260                       | 1605   | 1640     | 1675      |
| 043 SWIVEL ROCKING RECLINING CHAIR | 30x34x42    | 2235    | 2345                  | 2455   | 2565   | 2675                             | 2785                       | 1875   | 1920     | 1965      |
| 044 RECLINER CHAIR                 | 44x40x33/40 | 2275    | 2365                  | 2455   | 2545   | 2635                             | 2725                       | 1920   | 1970     | 2020      |
| 045 ARMLESS LOVESEAT BUMPER RIGHT  | 68x40x33/40 | 2245    | 2340                  | 2435   | 2530   | 2625                             | 2720                       | 1785   | 1850     | 1915      |
| 050 WEDGE                          | 49x49x33    | 1645    | 1745                  | 1845   | 1945   | 2045                             | 2145                       | 1210   | 1270     | 1330      |

## HAMBOURG

- Manual adjustable headrest on all items (2 on square corner & stationary on wedge).
- \*Wall hugger power recliners with full footrest (manual n/a).
- Power recliner lounge chair (manual n/a) with power headrest in option. Wall clearance 8" & front 5".
- Seat cushions with shaped foam + 1" layer of memory foam on top; arm with memory foam.
- Stitching: Small thread in fabric & large flat thread in leather.
- Chairs 043 & 163: arms with NO METAL insert.
- \*Excludes 043 & 163 chairs: Wall clearance 16"
- Note: 2 recliner seats separated by a corner can not be opened at the same time. No recliner seats beside item #155.

### OPTIONS

- Battery Pack: Add \$160/ea.
- \*Motorized headrest: Add \$160 ea. (\*N/A on stationary items).
- Foam: Extra firm add \$15/seat.
- Choice of arms: (Large or the Small 6" Arm which will have no metal insert in arm): Leg on LARGE arm: LG103 wood, Metal: LG189 cyl. (Black or Chrome). SMALL Arm: LG08 wood, Metal: LG196 cyl. (Black or Chrome) or LG64 (sq). Specify colour.
- Seat Depth: 20" or \*22". \*22" seat depth N/A on chairs 043 & 163.
- 043 & 163 Chairs: with wood base (specify colour).

### HOME THEATRE Configurations

For Accessories, Cup holders & Configuration details, see Optima Home Theatre page attached.

Accessory Dock : \$35 ea.

Cup Holders: Metal: \$25 ea. | LED lighted Cup Holder: \$25 ea. | \*LED lighted Cup Holder with (1 or 2 motor) controls: \$40 ea.

\*LED Light strip under seat: \$25/seat.

| Description                      | L x D x H     | Leather |                       |  |  |                                  |                            | Fabric |          |           |
|----------------------------------|---------------|---------|-----------------------|--|--|----------------------------------|----------------------------|--------|----------|-----------|
|                                  |               | 10      | 20<br>Madras<br>Softy | 30<br>Hugo<br>Fantasy<br>Illusion<br>Tucson<br>Utah<br>Vintage<br>Wild Laredo<br>Yukon | 40<br>Elegance<br>Princess<br>Santiago<br>Sensation<br>Sunset<br>Trina<br>Victoria | 50<br>Bull<br>Cassiope<br>Dublin | 60<br>Caresse<br>Ultrasued | A      | B<br>COM | C<br>alta |
| 051 ARMLESS CHAIR                | 23,5x40x33/40 | 1085    | 1135                  | 1185   | 1235   | 1285                             | 1335                       | 845    | 900      | 955       |
| 052 SOFA LEFT ARM                | 81x40x33/40   | 2870    | 3005                  | 3140   | 3275   | 3410                             | 3545                       | 2290   | 2385     | 2480      |
| 053 SOFA RIGHT ARM               | 81x40x33/40   | 2870    | 3005                  | 3140   | 3275   | 3410                             | 3545                       | 2290   | 2385     | 2480      |
| 055 SQUARE CORNER                | 44x44x33/40   | 1915    | 2010                  | 2105   | 2200   | 2295                             | 2390                       | 1510   | 1565     | 1620      |
| 056 CHAIR RIGHT ARM              | 34x40x33/40   | 1510    | 1575                  | 1640   | 1705   | 1770                             | 1835                       | 1200   | 1260     | 1320      |
| 057 CHAIR LEFT ARM               | 34x40x33/40   | 1510    | 1575                  | 1640   | 1705   | 1770                             | 1835                       | 1200   | 1260     | 1320      |
| 061 LOVESEAT RIGHT ARM           | 57x40x33/40   | 2320    | 2420                  | 2520   | 2620   | 2720                             | 2820                       | 1850   | 1925     | 2000      |
| 071 ARMLESS RECLINING CHAIR      | 23,5x40x33/40 | 1470    | 1525                  | 1580   | 1635   | 1690                             | 1745                       | 1250   | 1310     | 1370      |
| 086 ARMLESS LOVESEAT BUMPER LEFT | 68x40x33/40   | 2245    | 2340                  | 2435   | 2530   | 2625                             | 2720                       | 1785   | 1850     | 1915      |
| 088 ARMLESS CHAIR BUMPER LEFT    | 45x40x33/40   | 1440    | 1535                  | 1630   | 1725   | 1820                             | 1915                       | 1130   | 1165     | 1200      |
| 089 ARMLESS CHAIR BUMPER RIGHT   | 45x40x33/40   | 1440    | 1535                  | 1630   | 1725   | 1820                             | 1915                       | 1130   | 1165     | 1200      |
| 095 APARTMENT SOFA               | 81x40x33/40   | 2940    | 3085                  | 3230   | 3375   | 3520                             | 3665                       | 2350   | 2445     | 2540      |
| 096 APARTMENT SOFA LEFT ARM      | 71x40x33/40   | 2570    | 2680                  | 2790   | 2900   | 3010                             | 3120                       | 2020   | 2110     | 2200      |
| 097 APARTMENT SOFA RIGHT ARM     | 71x40x33/40   | 2570    | 2680                  | 2790   | 2900   | 3010                             | 3120                       | 2020   | 2110     | 2200      |
| 124 STORAGE OTTOMAN              | 30x22x17      | 745     | 765                   | 785  | 805  | 825                              | 845                        | 650    | 670      | 690       |
| 138 STRAIGHT ARM                 | 10x36x24.5    | 415     | 450                   | 485  | 520  | 555                              | 590                        | 350    | 365      | 380       |

## HAMBOURG

- Manual adjustable headrest on all items (2 on square corner & stationary on wedge).
- \*Wall hugger power recliners with full footrest (manual n/a).
- Power recliner lounge chair (manual n/a) with power headrest in option. Wall clearance 8" & front 5".
- Seat cushions with shaped foam + 1" layer of memory foam on top; arm with memory foam.
- Stitching: Small thread in fabric & large flat thread in leather.

Chairs 043 & 163: arms with NO METAL insert.

\*Excludes 043 & 163 chairs: Wall clearance 16"

Note: 2 recliner seats separated by a corner can not be opened at the same time. No recliner seats beside item #155.

### OPTIONS

-Battery Pack: Add \$160/ea.

-\*Motorized headrest: Add \$160 ea. (\*N/A on stationary items).

-Foam: Extra firm add \$15/seat.

-Choice of arms: (Large or the Small 6" Arm which will have no metal insert in arm): Leg on LARGE arm: LG103 wood, Metal: LG189 cyl. (Black or Chrome). SMALL Arm: LG08 wood, Metal: LG196 cyl. (Black or Chrome) or LG64 (sq). Specify colour.

-Seat Depth: 20" or \*22". \*22" seat depth N/A on chairs 043 & 163.

-043 & 163 Chairs: with wood base (specify colour).

### HOME THEATRE Configurations

For Accessories, Cup holders & Configuration details, see Optima Home Theatre page attached.

Accessory Dock : \$35 ea.

Cup Holders: Metal: \$25 ea. | LED lighted Cup Holder: \$25 ea. | \*LED lighted Cup Holder with (1 or 2 motor) controls: \$40 ea.

\*LED Light strip under seat: \$25/seat.

| Description                            | L x D x H     | Leather |                       |  |  |                                  |                           | Fabric |          |           |
|--|---------------|---------|-----------------------|--|--|----------------------------------|---------------------------|--------|----------|-----------|
|  |               | 10      | 20<br>Madras<br>Softy | 30<br>Hugo<br>Fantasy<br>Illusion<br>Tucson<br>Utah<br>Vintage<br>Wild Laredo<br>Yukon | 40<br>Elegance<br>Princess<br>Santiago<br>Sensation<br>Sunset<br>Trina<br>Victoria | 50<br>Bull<br>Cassiope<br>Dublin | 60<br>Caress<br>Ultrasued | A      | B<br>COM | C<br>alta |
| 155 SMALL SQUARE CORNER                | 40x40x33/40   | 1915    | 2010                  | 2105   | 2200   | 2295                             | 2390                      | 1510   | 1565     | 1620      |
| 159 WEDGE STORAGE                      | 11/27x36x24.5 | 745     | 775                   | 805  | 835  | 865                              | 895                       | 585    | 600      | 615       |
| 160 STRAIGHT STORAGE                   | 11x36x24.5    | 720     | 745                   | 770  | 795  | 820                              | 845                       | 550    | 570      | 590       |
| 163 DBL SWIVEL ROCKING RECLINER CHAIR  | 33x34x42      | 2290    | 2410                  | 2530   | 2650   | 2770                             | 2890                      | 1880   | 1930     | 1980      |
| 165 DOUBLE RECLINING CHAIR             | 51x40x33/40   | 2375    | 2475                  | 2575   | 2675   | 2775                             | 2875                      | 2000   | 2065     | 2130      |
| 167 APARTMENT SOFA NO ARM BUMPER LEFT  | 82x40x33/40   | 2490    | 2620                  | 2750   | 2880   | 3010                             | 3140                      | 1960   | 2045     | 2130      |
| 168 APARTMENT SOFA NO ARM BUMPER RIGHT | 82x40x33/40   | 2490    | 2620                  | 2750   | 2880   | 3010                             | 3140                      | 1960   | 2045     | 2130      |
| 169 DOUBLE RECLINING CHAIR LEFT ARM    | 41x40x33/40   | 1990    | 2070                  | 2150   | 2230   | 2310                             | 2390                      | 1670   | 1750     | 1830      |
| 170 DOUBLE RECLINING CHAIR RIGHT ARM   | 41x40x33/40   | 1990    | 2070                  | 2150   | 2230   | 2310                             | 2390                      | 1670   | 1750     | 1830      |
| 171 ARMLESS DOUBLE RECLINING CHAIR     | 30,5x40x33/40 | 1575    | 1625                  | 1675   | 1725   | 1775                             | 1825                      | 1320   | 1380     | 1440      |
| 173 DOUBLE LOUNGE CHAIR LEFT ARM       | 41x62x33/40   | 1915    | 2005                  | 2095   | 2185   | 2275                             | 2365                      | 1535   | 1615     | 1695      |
| 174 DOUBLE LOUNGE CHAIR RIGHT ARM      | 41x62x33/40   | 1915    | 2005                  | 2095   | 2185   | 2275                             | 2365                      | 1535   | 1615     | 1695      |
| 175 DOUBLE CHAIR LEFT ARM              | 41x40x33/40   | 1590    | 1680                  | 1770   | 1860   | 1950                             | 2040                      | 1285   | 1350     | 1415      |
| 176 DOUBLE CHAIR RIGHT ARM             | 41x40x33/40   | 1590    | 1680                  | 1770   | 1860   | 1950                             | 2040                      | 1285   | 1350     | 1415      |
| 177 ARMLESS DOUBLE CHAIR               | 30,5x40x33/40 | 1185    | 1250                  | 1315   | 1380   | 1445                             | 1510                      | 915    | 970      | 1025      |
| 178 ARMLESS DOUBLE CHAIR BUMPER LEFT   | 52x40x33/40   | 1545    | 1625                  | 1705   | 1785   | 1865                             | 1945                      | 1230   | 1290     | 1350      |

## HAMBOURG

- Manual adjustable headrest on all items (2 on square corner & stationary on wedge).
- \*Wall hugger power recliners with full footrest (manual n/a).
- Power recliner lounge chair (manual n/a) with power headrest in option. Wall clearance 8" & front 5".
- Seat cushions with shaped foam + 1" layer of memory foam on top; arm with memory foam.
- Stitching: Small thread in fabric & large flat thread in leather.
- Chairs 043 & 163: arms with NO METAL insert.
- \*Excludes 043 & 163 chairs: Wall clearance 16"
- Note: 2 recliner seats separated by a corner can not be opened at the same time. No recliner seats beside item #155.

### OPTIONS

- Battery Pack: Add \$160/ea.
- \*Motorized headrest: Add \$160 ea. (\*N/A on stationary items).
- Foam: Extra firm add \$15/seat.
- Choice of arms: (Large or the Small 6" Arm which will have no metal insert in arm): Leg on LARGE arm: LG103 wood, Metal: LG189 cyl. (Black or Chrome). SMALL Arm: LG08 wood, Metal: LG196 cyl. (Black or Chrome) or LG64 (sq). Specify colour.
- Seat Depth: 20" or \*22". \*22" seat depth N/A on chairs 043 & 163.
- 043 & 163 Chairs: with wood base (specify colour).

### HOME THEATRE Configurations

For Accessories, Cup holders & Configuration details, see Optima Home Theatre page attached.

Accessory Dock : \$35 ea.

Cup Holders: Metal: \$25 ea. | LED lighted Cup Holder: \$25 ea. | \*LED lighted Cup Holder with (1 or 2 motor) controls: \$40 ea.

\*LED Light strip under seat: \$25/seat.

| Description                            | L x D x H       | Leather |                       |  |  |                                  |                            | Fabric |          |           |
|--|-----------------|---------|-----------------------|--|--|----------------------------------|----------------------------|--------|----------|-----------|
|  |                 | 10      | 20<br>Madras<br>Softy | 30<br>Hugo<br>Fantasy<br>Illusion<br>Tucson<br>Utah<br>Vintage<br>Wild Laredo<br>Yukon | 40<br>Elegance<br>Princess<br>Santiago<br>Sensation<br>Sunset<br>Trina<br>Victoria | 50<br>Bull<br>Cassiope<br>Dublin | 60<br>Caresse<br>Ultrasued | A      | B<br>COM | C<br>alta |
| 179 ARMLESS DOUBLE CHAIR BUMPER RIGHT  | 52x40x33/40     | 1545    | 1625                  | 1705   | 1785   | 1865                             | 1945                       | 1230   | 1290     | 1350      |
| 186 ARMLESS LOVESEAT BUMPER STORAGE-L  | 68x40x33/40     | 2420    | 2500                  | 2580   | 2660   | 2740                             | 2820                       | 1950   | 2015     | 2080      |
| 187 ARMLESS LOVESEAT BUMPER STORAGE-R  | 68x40x33/40     | 2420    | 2500                  | 2580   | 2660   | 2740                             | 2820                       | 1950   | 2015     | 2080      |
| 188 ARMLESS CHAIR BUMPER STORAGE-L     | 45x40x33/40     | 1600    | 1690                  | 1780   | 1870   | 1960                             | 2050                       | 1295   | 1330     | 1365      |
| 189 ARMLESS CHAIR BUMPER STORAGE-R     | 45x40x33/40     | 1600    | 1690                  | 1780   | 1870   | 1960                             | 2050                       | 1295   | 1330     | 1365      |
| 190 SMALL WEDGE STORAGE                | 11/21x36x24.5   | 720     | 745                   | 770  | 795  | 820                              | 845                        | 550    | 570      | 590       |
| 221 ARMLESS DBL CHAIR BUMPER STORAGE-L | 52x40x33/40     | 1705    | 1790                  | 1875   | 1960   | 2045                             | 2130                       | 1390   | 1450     | 1510      |
| 222 ARMLESS DBL CHAIR BUMPER STORAGE-R | 52x40x33/40     | 1705    | 1790                  | 1875   | 1960   | 2045                             | 2130                       | 1390   | 1450     | 1510      |
| 223 APT SOFA NO ARM BUMPER STORAGE-L   | 82x40x33/40     | 2655    | 2785                  | 2915   | 3045   | 3175                             | 3305                       | 2120   | 2215     | 2310      |
| 224 APT SOFA NO ARM BUMPER STORAGE-R   | 82x40x33/40     | 2655    | 2785                  | 2915   | 3045   | 3175                             | 3305                       | 2120   | 2215     | 2310      |
| 236 RECLINING LOUNGE CHAIR LEFT ARM    | 34x62x33/40     | 2160    | 2225                  | 2290   | 2355   | 2420                             | 2485                       | 1820   | 1880     | 1940      |
| 237 RECLINING LOUNGE CHAIR RIGHT ARM   | 34x62x33/40     | 2160    | 2225                  | 2290   | 2355   | 2420                             | 2485                       | 1820   | 1880     | 1940      |
| 238 RECLINING DBL LOUNGE CHAIR L-ARM   | 41x62x33/40     | 2315    | 2405                  | 2495   | 2585   | 2675                             | 2765                       | 1940   | 2020     | 2100      |
| 239 RECLINING DBL LOUNGE CHAIR R-ARM   | 41x62x33/40     | 2315    | 2405                  | 2495   | 2585   | 2675                             | 2765                       | 1940   | 2020     | 2100      |
| V51 WINE GLASS HOLDER                  | 3.5 x 5.5 x 6.5 | 35      | 35                    | 35   | 35   | 35                               | 35                         | 35     | 35       | 35        |
| V52 PLASTIC SWIVEL TRAY                | 13 3/8 x 9 5/8  | 35      | 35                    | 35   | 35   | 35                               | 35                         | 35     | 35       | 35        |

## HAMBOURG

- Manual adjustable headrest on all items (2 on square corner & stationary on wedge).
- \*Wall hugger power recliners with full footrest (manual n/a).
- Power recliner lounge chair (manual n/a) with power headrest in option. Wall clearance 8" & front 5".
- Seat cushions with shaped foam + 1" layer of memory foam on top; arm with memory foam.
- Stitching: Small thread in fabric & large flat thread in leather.
- Chairs 043 & 163: arms with NO METAL insert.
- \*Excludes 043 & 163 chairs: Wall clearance 16"
- Note: 2 recliner seats separated by a corner can not be opened at the same time. No recliner seats beside item #155.

### OPTIONS

- Battery Pack: Add \$160/ea.
- \*Motorized headrest: Add \$160 ea. (\*N/A on stationary items).
- Foam: Extra firm add \$15/seat.
- Choice of arms: (Large or the Small 6" Arm which will have no metal insert in arm): Leg on LARGE arm: LG103 wood, Metal: LG189 cyl. (Black or Chrome). SMALL Arm: LG08 wood, Metal: LG196 cyl. (Black or Chrome) or LG64 (sq). Specify colour.
- Seat Depth: 20" or \*22". \*22" seat depth N/A on chairs 043 & 163.
- 043 & 163 Chairs: with wood base (specify colour).

### HOME THEATRE Configurations

For Accessories, Cup holders & Configuration details, see Optima Home Theatre page attached.

Accessory Dock : \$35 ea.

Cup Holders: Metal: \$25 ea. | LED lighted Cup Holder: \$25 ea. | \*LED lighted Cup Holder with (1 or 2 motor) controls: \$40 ea.

\*LED Light strip under seat: \$25/seat.

| Description                 | L x D x H          | Leather |                       |  |  |                                  |                           | Fabric |          |           |
|-----------------------------|--------------------|---------|-----------------------|--|--|----------------------------------|---------------------------|--------|----------|-----------|
|                             |                    | 10      | 20<br>Madras<br>Softy | 30<br>Hugo<br>Fantasy<br>Illusion<br>Tucson<br>Utah<br>Vintage<br>Wild Laredo<br>Yukon | 40<br>Elegance<br>Princess<br>Santiago<br>Sensation<br>Sunset<br>Trina<br>Victoria | 50<br>Bull<br>Cassiope<br>Dublin | 60<br>Caress<br>Ultrasued | A      | B<br>COM | C<br>alta |
| V53 WOOD SWIVEL TRAY        | 19 x 10            | 60      | 60                    | 60   | 60   | 60                               | 60                        | 60     | 60       | 60        |
| V54 TABLET HOLDER           | 4.5 x 8 x 10       | 40      | 40                    | 40   | 40   | 40                               | 40                        | 40     | 40       | 40        |
| V55 LED LAMP                | 1.5x5x14 pli /bent | 35      | 35                    | 35   | 35   | 35                               | 35                        | 35     | 35       | 35        |
| <b>CONFIGURATIONS</b>       |                    |         |                       |  |  |                                  |                           |        |          |           |
| _A CONFIG (169-170)         | 82X40X40           | 3980    | 4140                  | 4300   | 4460   | 4620                             | 4780                      | 3340   | 3500     | 3660      |
| _B CONFIG (169-171-174)     | 113X62X40          | 5480    | 5700                  | 5920   | 6140   | 6360                             | 6580                      | 4525   | 4745     | 4965      |
| _C CONFIG (096-055-171-170) | 115X115X40         | 8050    | 8385                  | 8720   | 9055   | 9390                             | 9725                      | 6520   | 6805     | 7090      |
| _D CONFIG (169-171-055-179) | 115X96X40          | 7025    | 7330                  | 7635   | 7940   | 8245                             | 8550                      | 5730   | 5985     | 6240      |
| _J CONFIG (041-042)         | 68X40X40           | 3770    | 3920                  | 4070   | 4220   | 4370                             | 4520                      | 3210   | 3280     | 3350      |
| _K CONFIG (041-071-005)     | 92X62X40           | 5120    | 5315                  | 5510   | 5705   | 5900                             | 6095                      | 4265   | 4420     | 4575      |
| _L CONFIG (012-055-071-042) | 102X102X40         | 7590    | 7915                  | 8240   | 8565   | 8890                             | 9215                      | 6215   | 6440     | 6665      |
| _M CONFIG (041-071-055-089) | 102X89X40          | 6710    | 7030                  | 7350   | 7670   | 7990                             | 8310                      | 5495   | 5680     | 5865      |



# HAMBURG

**OPTIMA**  
Collection

**Jaymar**

Conçu et fabriqué fièrement au Canada  
Proudly designed and made in Canada

Nos produits sont fabriqués à la main et des variations mineures peuvent survenir

Our product is hand-made and minor variations can occur.

## SPECIFICATIONS

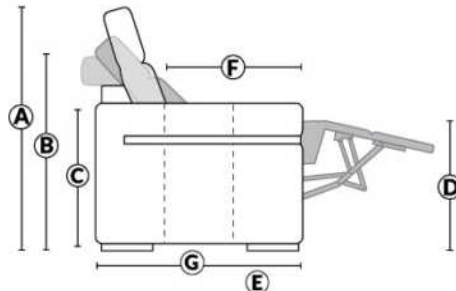

- Appui-tête levé Headrest up
- Appui-tête baissé Headrest down
- Complètement incliné Fully reclined

- A** Hauteur complète 40" Total Height
- B** Hauteur appui-tête baissé 33" Height headrest down
- C** Hauteur du bras 24,5" Arm Height
- D** Hauteur du siège 19,5" Seat height
- E** Profondeur inclinée 65" Depth fully reclined
- F** Profondeur d'assise 20"ou/ou 22" Seat depth
- G** Profondeur appui-tête monté 37,5" Depth with headrest up

## BRAS | ARMS

Option de bras:  
Bras Régulier Large 10" ou Petit bras 6"

Arm option  
Regular arm Large 10" or Small arm 6"

Contrôle de l'inclinaison situé à l'intérieur du bras  
Recliner control located on the inside of the arm.

Option d'accessoires disponible sur le bras régulier seulement  
Accessories option, available on Regular arms ONLY.

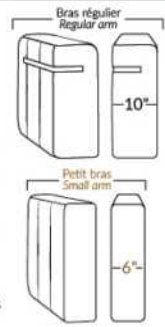

## FAUTEUIL BERÇANT PIVOTANT INCLINABLE SWIVEL ROCKING MOTION CHAIR

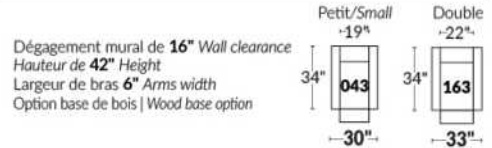

## SIÈGE 23" DE LARGE | 23" SEAT WIDTH

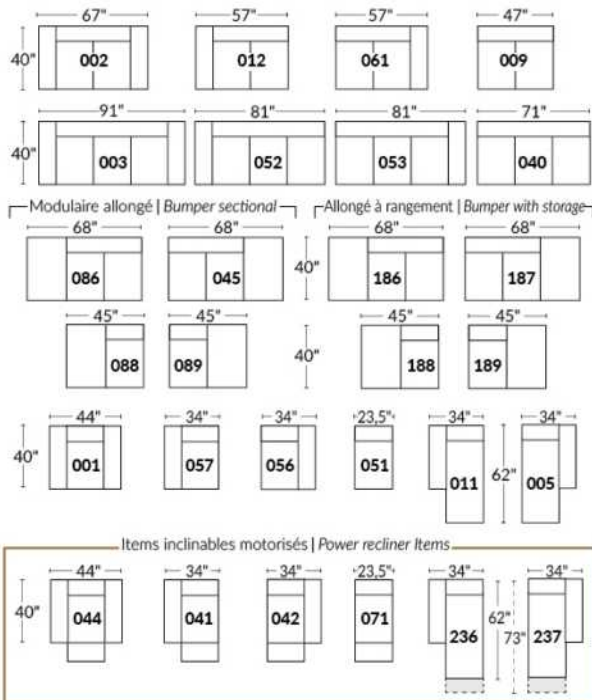

## SIÈGE 30" DE LARGE | 30" SEAT WIDTH

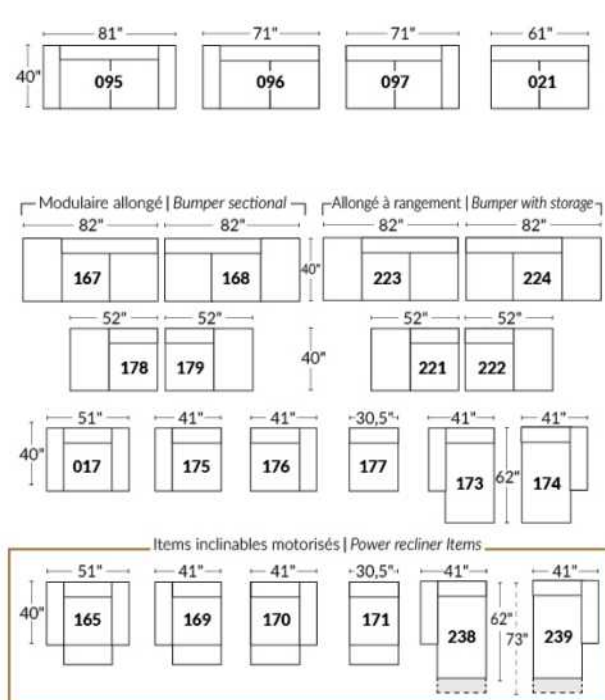

### Autres | Others

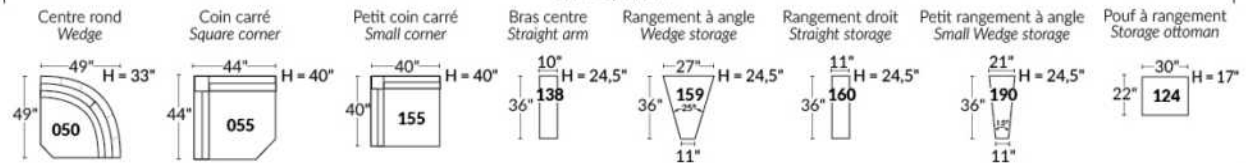

### EXEMPLE 23" EXAMPLE

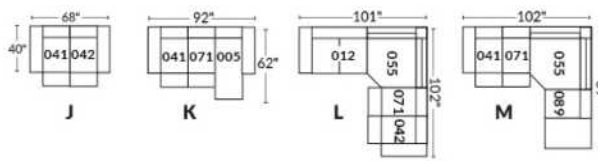

### EXEMPLE 30" EXAMPLE

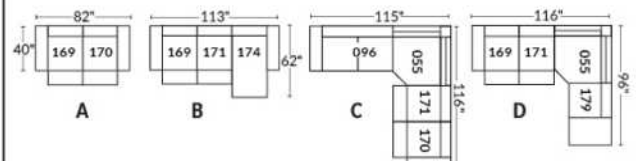



\*Available on certain models and on large arms ONLY.

### OPTIONS CUP HOLDERS

#### METAL



Silver



Matte Black



Brown

#### ILLUMINATED

1.



LED Lighted Cup holder

2.



LED Lighted Cup holder with Single Motor Control, USB Port and LED Base rail

3.



LED Lighted Cup holder with Dual Motor Control, USB Port and LED Base rail

Our illuminated one or two-control cup holders are compatible with LED lights under the seat. You can control the light on the cup holder. The 2 motor cup holder has a reset (home) button control to close your recliner back to its starting position.

#### LED Light under seat (Optional)

Available only in configurations with a minimum of 1 illuminated motorized cup holder with control buttons. The "light" button will control the opening and closing of the light.

For cup holder prices see description section of the Optima model price list.

Please provide us with a drawing of your configuration which indicates the cup holder type and its positioning.

#### Cup holder with controller:

It is important to specify the placement of the cups; on left arm or right arm and which recliner they will control. If you have a row of several seats with cup holders, by default, the controls will be on the left arms and on the right arm for the last outer chair.

#### EXAMPLE A:

041-169: Controller and cup holder on the left arm

071-171: hidden touch sensor buttons on side of seat

042-170: Controller and cup holder on right arm



#### EXAMPLE B:

071-171: These two items can be connected to a smart cup holder which will control the recliner. You must then use one of these items: 138,159, 160 and 190



#### Informations about headrest, controller on reclining seat

#### WITH illuminated cup holder

If you have a **stationary item**, you will have cup holder N°1.

If you have a recliner chair with a **manual headrest**, you will have the cup holder N°2.

If you have a recliner chair with an **electric headrest**, you will have cup holder N°3.

#### Without cup holder and with a reclining seat

If you have a recliner with a **manual headrest** you will have the touch sensor button control on the side of the seat.

If you have a recliner with an **electric headrest** you will have a dual push button controller with USB port on the arm.

If you have an **armless recliner**, you will have the hidden touch sensor button control.



Hidden touch sensor



Dual push button

# OPTIMA

## HOME THEATRE Configurations

\*Available on certain models and on large arms ONLY.

OPTIONS

### ACCESSORIES

Accessory Dock



V51 Wine Glass Holder



V52 Plastic Swivel Tray Table



V53 Wood Swivel tray Table  
(Choice of 8 colors)



Specify on which arm (left or right) the tray table will be installed.

V54 Tablet Holder



V55 LED Lamp



(For Accessory Dock price, see description section of the Optima model price list and for Accessory item prices, see at very end of the price list)

#### Items 138-159-160-190 and large arm.

Accessory docks and cups are Optional. \*Not available on small arms\*

Please specify on which arms you want the accessory docks and cup holders.

NB: Item 138-159-160-190 are unfinished on the sides, must be used between 2 seats.

Each storage item has 2 USB ports and one electrical outlet inside the storage.



#### SUGGESTED CONFIGURATIONS

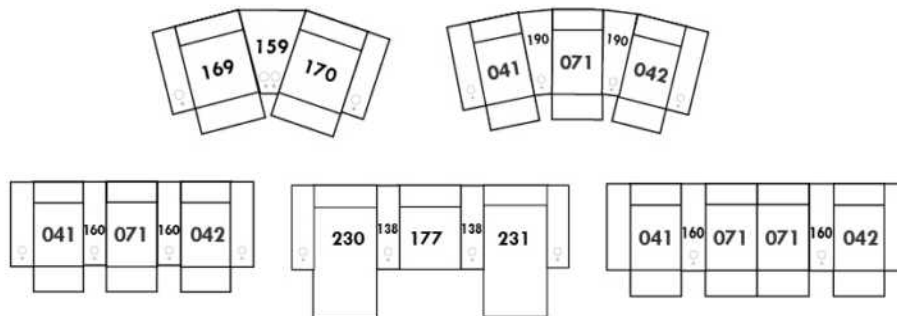

## CDN Price List

### HARRISON

COMBO: Cover #2 on back and seat.

FABRIC: There is no stitching on back cushions.

SPECS: Arm Height: 26". Seat Height: 19" Seat Depth: 21".

LEG: LG58 (specify colour).

Decorative Nails: On front arm, add \$35/arm. Nail #54 5/8" Antique Gold (only 1 colour).

Sofa bed MATTRESS: Regular 4.5" mattress included. OPTIONAL 5" mattress:

-with coils and memory foam with gel: Double add \$100 or

-with high density foam and memory foam with gel: Double add \$150.

| Description         | L x D x H    | Leather |                       |  |  |                                  |                           | Fabric |          |           |
|---------------------|--------------|---------|-----------------------|--|--|----------------------------------|---------------------------|--------|----------|-----------|
|                     |              | 10      | 20<br>Madras<br>Softy | 30<br>Hugo<br>Fantasy<br>Illusion<br>Tucson<br>Utah<br>Vintage<br>Wild Laredo<br>Yukon | 40<br>Elegance<br>Princess<br>Santiago<br>Sensation<br>Sunset<br>Trina<br>Victoria | 50<br>Bull<br>Cassiope<br>Dublin | 60<br>Caress<br>Ultrasued | A      | B<br>COM | C<br>alta |
| 001 CHAIR           | 43X37X36     | 1505    | 1590                  | 1675   | 1760   | 1845                             | 1930                      | 1030   | 1090     | 1150      |
| 002 LOVESEAT        | 64X37X36     | 2050    | 2165                  | 2280   | 2395   | 2510                             | 2625                      | 1395   | 1475     | 1555      |
| 003 SOFA            | 86X37X36     | 2495    | 2660                  | 2825   | 2990   | 3155                             | 3320                      | 1750   | 1840     | 1930      |
| 004 DOUBLE SOFA BED | 86X37X36     | 2705    | 2875                  | 3045   | 3215   | 3385                             | 3555                      | 1980   | 2070     | 2160      |
| 006 OTTOMAN         | 25.5X25.5X18 | 685     | 710                   | 735  | 760  | 785                              | 810                       | 550    | 570      | 590       |

# HARRISON



Hauteur complète 36" | Hauteur de siège 19" | Hauteur devant bras 26" | Profondeur d'assise 21"  
Total Height 36" | Seat Height 19" | Arm Height 26" | Seat Depth 21"

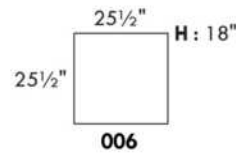
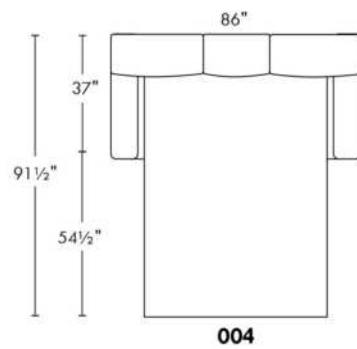
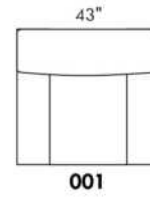
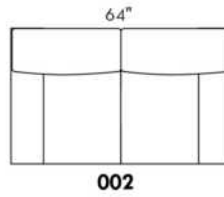
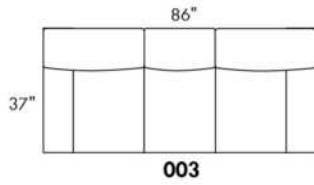

[www.jaymar.ca](http://www.jaymar.ca)

Toutes les dimensions indiquées sont au pouce près. Nos produits sont fabriqués à la main et des variations mineures peuvent survenir.  
All dimensions indicated are to the nearest inch. Our product is hand-made and minor variations can occur.

## CDN Price List

### HENLEY

LEG: LG64 metal. Also available in wood leg LG8; specify colour.  
COMBO: Cover #2 on back and seat. PLAIN FABRIC RECOMMENDED.

Sofa bed MATTRESS: Regular 4.5" mattress included. OPTIONAL 5" mattress:  
-with coils and memory foam with gel: add \$100 or  
-with high density foam and memory foam with gel: add \$150.

\*REMARK: In leather, armless end pieces are not fully upholstered.

| Description                    | L x D x H    | Leather |                       |  |  |                                  |                           | Fabric |          |           |
|--------------------------------|--------------|---------|-----------------------|--|--|----------------------------------|---------------------------|--------|----------|-----------|
|                                |              | 10      | 20<br>Madras<br>Softy | 30<br>Hugo<br>Fantasy<br>Illusion<br>Tucson<br>Utah<br>Vintage<br>Wild Laredo<br>Yukon | 40<br>Elegance<br>Princess<br>Santiago<br>Sensation<br>Sunset<br>Trina<br>Victoria | 50<br>Bull<br>Cassiope<br>Dublin | 60<br>Caress<br>Ultrasued | A      | B<br>COM | C<br>alta |
| 001 CHAIR                      | 34X37X35     | 1460    | 1550                  | 1640   | 1730   | 1820                             | 1910                      | 1030   | 1095     | 1160      |
| 002 LOVESEAT                   | 58X37X35     | 2065    | 2180                  | 2295   | 2410   | 2525                             | 2640                      | 1425   | 1505     | 1585      |
| 003 SOFA                       | 81X37X35     | 2595    | 2710                  | 2825   | 2940   | 3055                             | 3170                      | 1820   | 1900     | 1980      |
| 005 LOUNGE CHAIR RIGHT ARM     | 29X66X35     | 1695    | 1790                  | 1885   | 1980   | 2075                             | 2170                      | 1255   | 1320     | 1385      |
| 006 OTTOMAN                    | 25.5X25.5X18 | 685     | 710                   | 735  | 760  | 785                              | 810                       | 550    | 570      | 590       |
| 009 ARMLESS LOVESEAT           | 46X37X35     | 1575    | 1695                  | 1815   | 1935   | 2055                             | 2175                      | 1170   | 1250     | 1330      |
| 011 LOUNGE CHAIR LEFT ARM      | 29X66X36     | 1695    | 1790                  | 1885   | 1980   | 2075                             | 2170                      | 1255   | 1320     | 1385      |
| 012 LOVESEAT LEFT ARM          | 52X37X35     | 1815    | 1945                  | 2075   | 2205   | 2335                             | 2465                      | 1305   | 1365     | 1425      |
| 018 ANGULAR LOVESEAT LEFT ARM  | 64X54X35     | 1955    | 2070                  | 2185   | 2300   | 2415                             | 2530                      | 1390   | 1475     | 1560      |
| 023 ANGULAR LOVESEAT RIGHT ARM | 64X54X35     | 1955    | 2070                  | 2185   | 2300   | 2415                             | 2530                      | 1390   | 1475     | 1560      |
| 040 ARMLESS SOFA               | 69X37X35     | 2100    | 2265                  | 2430   | 2595   | 2760                             | 2925                      | 1570   | 1640     | 1710      |
| 046 ARMLESS ANGULAR LOVESEAT   | 60X51X35     | 1775    | 1910                  | 2045   | 2180   | 2315                             | 2450                      | 1285   | 1350     | 1415      |
| 050 WEDGE                      | 48X48X35     | 1510    | 1605                  | 1700   | 1795   | 1890                             | 1985                      | 1150   | 1215     | 1280      |
| 051 ARMLESS CHAIR              | 23X37X35     | 985     | 1075                  | 1165   | 1255   | 1345                             | 1435                      | 800    | 880      | 960       |
| 052 SOFA LEFT ARM              | 75X37X35     | 2320    | 2455                  | 2590   | 2725   | 2860                             | 2995                      | 1685   | 1785     | 1885      |
| 053 SOFA RIGHT ARM             | 75X37X35     | 2320    | 2455                  | 2590   | 2725   | 2860                             | 2995                      | 1685   | 1785     | 1885      |
| 055 SQUARE CORNER              | 37X37X55     | 1470    | 1570                  | 1670   | 1770   | 1870                             | 1970                      | 1100   | 1150     | 1200      |
| 056 CHAIR RIGHT ARM            | 29X37X35     | 1210    | 1305                  | 1400   | 1495   | 1590                             | 1685                      | 910    | 970      | 1030      |
| 057 CHAIR LEFT ARM             | 29X37X35     | 1210    | 1305                  | 1400   | 1495   | 1590                             | 1685                      | 910    | 970      | 1030      |
| 060 QUEEN SOFA BED             | 81X37X35     | 2965    | 3105                  | 3245   | 3385   | 3525                             | 3665                      | 2225   | 2320     | 2415      |
| 061 LOVESEAT RIGHT ARM         | 52X37X35     | 1815    | 1945                  | 2075   | 2205   | 2335                             | 2465                      | 1305   | 1365     | 1425      |
| 072 SECTIONAL SOFA LEFT ARM    | 87X37X35     | 2750    | 2900                  | 3050   | 3200   | 3350                             | 3500                      | 1955   | 2035     | 2115      |
| 073 SECTIONAL SOFA RIGHT ARM   | 87X37X35     | 2750    | 2900                  | 3050   | 3200   | 3350                             | 3500                      | 1955   | 2035     | 2115      |
| 080 ANGULAR OTTOMAN            | 36X37X18     | 755     | 780                   | 805  | 830  | 855                              | 880                       | 645    | 670      | 695       |
| 082 QUEEN SOFA BED LEFT ARM    | 75X37X35     | 2705    | 2850                  | 2995   | 3140   | 3285                             | 3430                      | 2095   | 2185     | 2275      |

## CDN Price List

### HENLEY

LEG: LG64 metal. Also available in wood leg LG8; specify colour.  
COMBO: Cover #2 on back and seat. PLAIN FABRIC RECOMMENDED.

Sofa bed MATTRESS: Regular 4.5" mattress included. OPTIONAL 5" mattress:  
-with coils and memory foam with gel: add \$100 or  
-with high density foam and memory foam with gel: add \$150.

\*REMARK: In leather, armless end pieces are not fully upholstered.

| Description                           | L x D x H  | Leather |                       |  |  |                                  |                           | Fabric |          |           |
|---------------------------------------|------------|---------|-----------------------|--|--|----------------------------------|---------------------------|--------|----------|-----------|
|                                       |            | 10      | 20<br>Madras<br>Softy | 30<br>Hugo<br>Fantasy<br>Illusion<br>Tucson<br>Utah<br>Vintage<br>Wild Laredo<br>Yukon | 40<br>Elegance<br>Princess<br>Santiago<br>Sensation<br>Sunset<br>Trina<br>Victoria | 50<br>Bull<br>Cassiope<br>Dublin | 60<br>Caress<br>Ultrasued | A      | B<br>COM | C<br>alta |
| 083 QUEEN SOFA BED RIGHT ARM          | 75X37X35   | 2705    | 2850                  | 2995   | 3140   | 3285                             | 3430                      | 2095   | 2185     | 2275      |
| 084 ARMLESS ANGULAR LOVESEAT BUMPER-L | 72X63X35   | 1985    | 2120                  | 2255   | 2390   | 2525                             | 2660                      | 1450   | 1530     | 1610      |
| 085 ARMLESS ANGULAR LOVESEAT BUMPER-R | 72X63X35   | 1985    | 2120                  | 2255   | 2390   | 2525                             | 2660                      | 1450   | 1530     | 1610      |
| <b>CONFIGURATIONS</b>                 |            |         |                       |  |  |                                  |                           |        |          |           |
| A CONF. A (084-083)                   | 147X63X35  | 4690    | 4970                  | 5250   | 5530   | 5810                             | 6090                      | 3545   | 3715     | 3885      |
| B CONF. B (052-073)                   | 87X112X35  | 5070    | 5355                  | 5640   | 5925   | 6210                             | 6495                      | 3640   | 3820     | 4000      |
| C CONF. C (012-055-056)               | 89X66X35   | 4495    | 4820                  | 5145   | 5470   | 5795                             | 6120                      | 3315   | 3485     | 3655      |
| D CONF. D (012-085)                   | 124X63X35  | 3800    | 4065                  | 4330   | 4595   | 4860                             | 5125                      | 2755   | 2895     | 3035      |
| E CONF. E (084-085)                   | 144X63X35  | 3970    | 4240                  | 4510   | 4780   | 5050                             | 5320                      | 2900   | 3060     | 3220      |
| F CONF. F (012-050-061)               | 100X100X35 | 5140    | 5495                  | 5850   | 6205   | 6560                             | 6915                      | 3760   | 3945     | 4130      |
| G CONF. G (057-046-051-005)           | 133X72X35  | 5665    | 6080                  | 6495   | 6910   | 7325                             | 7740                      | 4250   | 4520     | 4790      |
| H CONF. H (052-050-061)               | 123X100X35 | 5645    | 6005                  | 6365   | 6725   | 7085                             | 7445                      | 4140   | 4365     | 4590      |
| I CONF. I (018-046-023)               | 161X79X35  | 5685    | 6050                  | 6415   | 6780   | 7145                             | 7510                      | 4065   | 4300     | 4535      |
| J CONF. J (057-046-056)               | 119X59X35  | 4195    | 4520                  | 4845   | 5170   | 5495                             | 5820                      | 3105   | 3290     | 3475      |

Hauteur complète 35" | Hauteur de siège 19" | Hauteur devant bras 24" | Profondeur d'assise 20"  
 Total Height 35" | Seat Height 19" | Arm Height 24" | Seat Depth 20"

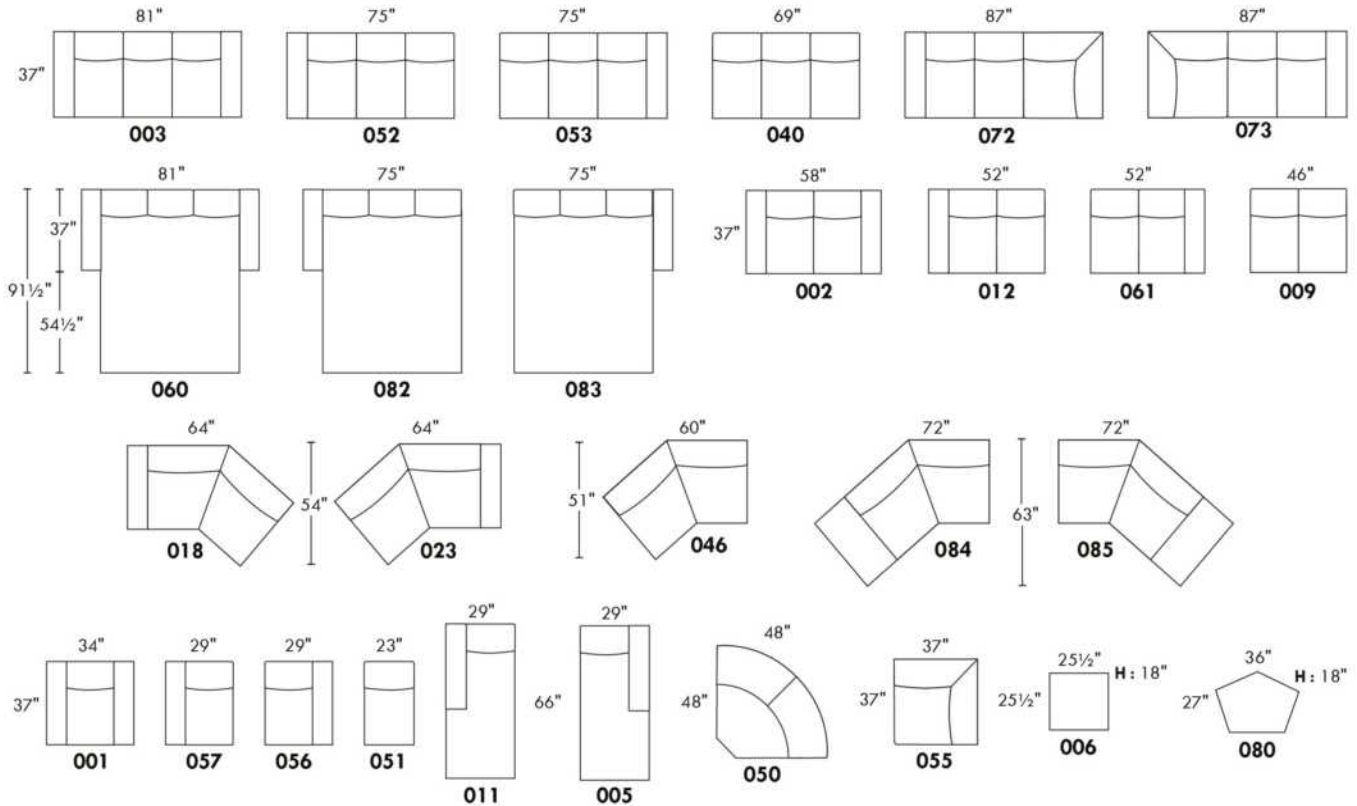

## CONFIGURATIONS

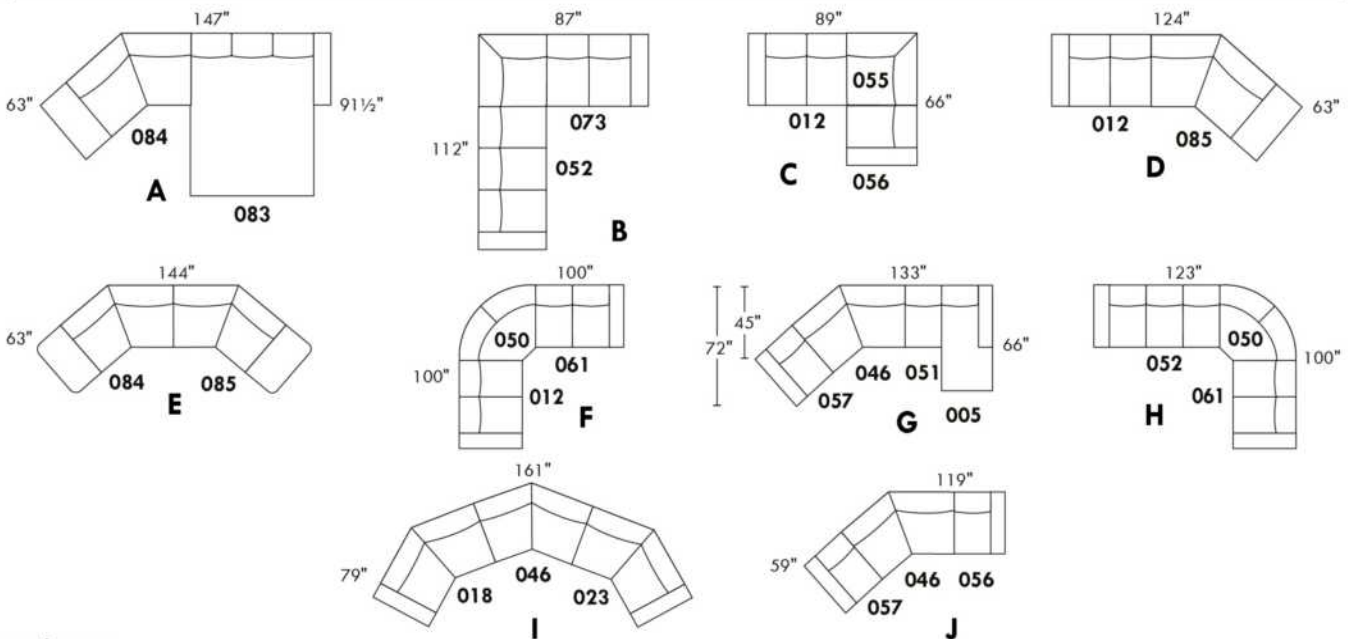

www.jaymar.ca

Toutes les dimensions indiquées sont au pouce près. Nos produits sont fabriqués à la main et des variations mineures peuvent survenir.  
 All dimensions indicated are to the nearest inch. Our product is hand-made and minor variations can occur.

## CDN Price List

### HIGH POINT

LEG: LG64 metal. or wood leg LG8; if wood specify colour.  
COMBO: Cover #2 on back and seat.  
PLAIN FABRIC RECOMMENDED.

Sofa bed MATTRESS: Regular 4.5" mattress included. OPTIONAL 5" mattress:  
-with coils and memory foam with gel: add \$100 or  
-with high density foam and memory foam with gel: add \$150.

\*REMARK: In leather, armless end pieces are not fully upholstered.

| Description                    | L x D x H    | Leather |                       |  |  |                                  |                           | Fabric |          |           |
|--------------------------------|--------------|---------|-----------------------|--|--|----------------------------------|---------------------------|--------|----------|-----------|
|                                |              | 10      | 20<br>Madras<br>Softy | 30<br>Hugo<br>Fantasy<br>Illusion<br>Tucson<br>Utah<br>Vintage<br>Wild Laredo<br>Yukon | 40<br>Elegance<br>Princess<br>Santiago<br>Sensation<br>Sunset<br>Trina<br>Victoria | 50<br>Bull<br>Cassiope<br>Dublin | 60<br>Caress<br>Ultrasued | A      | B<br>COM | C<br>alta |
| 001 CHAIR                      | 34X37X35     | 1460    | 1550                  | 1640   | 1730   | 1820                             | 1910                      | 1030   | 1095     | 1160      |
| 002 LOVESEAT                   | 58X37X35     | 2065    | 2180                  | 2295   | 2410   | 2525                             | 2640                      | 1425   | 1505     | 1585      |
| 003 SOFA                       | 81X37X35     | 2595    | 2710                  | 2825   | 2940   | 3055                             | 3170                      | 1820   | 1900     | 1980      |
| 005 LOUNGE CHAIR RIGHT ARM     | 29X66X35     | 1695    | 1790                  | 1885   | 1980   | 2075                             | 2170                      | 1255   | 1320     | 1385      |
| 006 OTTOMAN                    | 25.5X25.5X18 | 685     | 710                   | 735  | 760  | 785                              | 810                       | 550    | 570      | 590       |
| 009 ARMLESS LOVESEAT           | 46X37X35     | 1575    | 1695                  | 1815   | 1935   | 2055                             | 2175                      | 1170   | 1250     | 1330      |
| 011 LOUNGE CHAIR LEFT ARM      | 29X66X35     | 1695    | 1790                  | 1885   | 1980   | 2075                             | 2170                      | 1255   | 1320     | 1385      |
| 012 LOVESEAT LEFT ARM          | 52X37X35     | 1815    | 1945                  | 2075   | 2205   | 2335                             | 2465                      | 1305   | 1365     | 1425      |
| 018 ANGULAR LOVESEAT LEFT ARM  | 66X51X35     | 1955    | 2070                  | 2185   | 2300   | 2415                             | 2530                      | 1390   | 1475     | 1560      |
| 023 ANGULAR LOVESEAT RIGHT ARM | 66X51X35     | 1955    | 2070                  | 2185   | 2300   | 2415                             | 2530                      | 1390   | 1475     | 1560      |
| 040 ARMLESS SOFA               | 69X37X35     | 2100    | 2265                  | 2430   | 2595   | 2760                             | 2925                      | 1570   | 1640     | 1710      |
| 046 ARMLESS ANGULAR LOVESEAT   | 60X51X35     | 1775    | 1910                  | 2045   | 2180   | 2315                             | 2450                      | 1285   | 1350     | 1415      |
| 050 WEDGE                      | 48X48X35     | 1510    | 1605                  | 1700   | 1795   | 1890                             | 1985                      | 1150   | 1215     | 1280      |
| 051 ARMLESS CHAIR              | 23X37X35     | 985     | 1075                  | 1165   | 1255   | 1345                             | 1435                      | 800    | 880      | 960       |
| 052 SOFA LEFT ARM              | 75X37X35     | 2320    | 2455                  | 2590   | 2725   | 2860                             | 2995                      | 1685   | 1785     | 1885      |
| 053 SOFA RIGHT ARM             | 75X37X35     | 2320    | 2455                  | 2590   | 2725   | 2860                             | 2995                      | 1685   | 1785     | 1885      |
| 055 SQUARE CORNER              | 37X37X35     | 1470    | 1570                  | 1670   | 1770   | 1870                             | 1970                      | 1100   | 1150     | 1200      |
| 056 CHAIR RIGHT ARM            | 29X37X35     | 1210    | 1305                  | 1400   | 1495   | 1590                             | 1685                      | 910    | 970      | 1030      |
| 057 CHAIR LEFT ARM             | 29X37X35     | 1210    | 1305                  | 1400   | 1495   | 1590                             | 1685                      | 910    | 970      | 1030      |
| 060 QUEEN SOFA BED             | 81X37X35     | 2965    | 3105                  | 3245   | 3385   | 3525                             | 3665                      | 2225   | 2320     | 2415      |
| 061 LOVESEAT RIGHT ARM         | 52X37X35     | 1815    | 1945                  | 2075   | 2205   | 2335                             | 2465                      | 1305   | 1365     | 1425      |
| 072 SECTIONAL SOFA LEFT ARM    | 87X37X35     | 2750    | 2900                  | 3050   | 3200   | 3350                             | 3500                      | 1955   | 2035     | 2115      |
| 073 SECTIONAL SOFA RIGHT ARM   | 87X37X35     | 2750    | 2900                  | 3050   | 3200   | 3350                             | 3500                      | 1955   | 2035     | 2115      |
| 080 ANGULAR OTTOMAN            | 36X27X18     | 755     | 780                   | 805  | 830  | 855                              | 880                       | 645    | 670      | 695       |



## CDN Price List

### HIGH POINT

LEG: LG64 metal. or wood leg LG8; if wood specify colour.  
COMBO: Cover #2 on back and seat.  
PLAIN FABRIC RECOMMENDED.

Sofa bed MATTRESS: Regular 4.5" mattress included. OPTIONAL 5" mattress:  
-with coils and memory foam with gel: add \$100 or  
-with high density foam and memory foam with gel: add \$150.

\*REMARK: In leather, armless end pieces are not fully upholstered.

| Description                           | L x D x H  | Leather |                       |  |  |                                  |                           | Fabric |          |           |
|---------------------------------------|------------|---------|-----------------------|--|--|----------------------------------|---------------------------|--------|----------|-----------|
|                                       |            | 10      | 20<br>Madras<br>Softy | 30<br>Hugo<br>Fantasy<br>Illusion<br>Tucson<br>Utah<br>Vintage<br>Wild Laredo<br>Yukon | 40<br>Elegance<br>Princess<br>Santiago<br>Sensation<br>Sunset<br>Trina<br>Victoria | 50<br>Bull<br>Cassiope<br>Dublin | 60<br>Caress<br>Ultrasued | A      | B<br>COM | C<br>alta |
| 082 QUEEN SOFA BED LEFT ARM           | 75X37X35   | 2705    | 2850                  | 2995   | 3140   | 3285                             | 3430                      | 2095   | 2185     | 2275      |
| 083 QUEEN SOFA BED RIGHT ARM          | 75X37X35   | 2705    | 2850                  | 2995   | 3140   | 3285                             | 3430                      | 2095   | 2185     | 2275      |
| 084 ARMLESS ANGULAR LOVESEAT BUMPER-L | 72X63X35   | 1985    | 2120                  | 2255   | 2390   | 2525                             | 2660                      | 1450   | 1530     | 1610      |
| 085 ARMLESS ANGULAR LOVESEAT BUMPER-R | 72X63X35   | 1985    | 2120                  | 2255   | 2390   | 2525                             | 2660                      | 1450   | 1530     | 1610      |
| <b>CONFIGURATIONS</b>                 |            |         |                       |  |  |                                  |                           |        |          |           |
| A CONF. A (084-083)                   | 147X63X35  | 4690    | 4970                  | 5250   | 5530   | 5810                             | 6090                      | 3545   | 3715     | 3885      |
| B CONF. B (012-055-056)               | 89X66X35   | 4495    | 4820                  | 5145   | 5470   | 5795                             | 6120                      | 3315   | 3485     | 3655      |
| C CONF. C (052-073)                   | 87X112X35  | 5070    | 5355                  | 5640   | 5925   | 6210                             | 6495                      | 3640   | 3820     | 4000      |
| D CONF. D (012-085)                   | 124X63X35  | 3800    | 4065                  | 4330   | 4595   | 4860                             | 5125                      | 2755   | 2895     | 3035      |
| E CONF. E (012-050-061)               | 100X100X35 | 5140    | 5495                  | 5850   | 6205   | 6560                             | 6915                      | 3760   | 3945     | 4130      |
| F CONF. F (084-085)                   | 144X63X35  | 3970    | 4240                  | 4510   | 4780   | 5050                             | 5320                      | 2900   | 3060     | 3220      |
| G CONF. G (057-046-051-005)           | 133X72X35  | 5665    | 6080                  | 6495   | 6910   | 7325                             | 7740                      | 4250   | 4520     | 4790      |
| H CONF. H (052-050-061)               | 123X100X35 | 5645    | 6005                  | 6365   | 6725   | 7085                             | 7445                      | 4140   | 4365     | 4590      |
| I CONF. I (018-046-023)               | 161X79X35  | 5685    | 6050                  | 6415   | 6780   | 7145                             | 7510                      | 4065   | 4300     | 4535      |
| J CONF. J (057-046-056)               | 119X59X35  | 4195    | 4520                  | 4845   | 5170   | 5495                             | 5820                      | 3105   | 3290     | 3475      |

# HIGH POINT



Hauteur complète 35" | Hauteur de siège 19" | Hauteur devant bras 25" | Profondeur d'assise 20"  
 Total Height 35" | Seat Height 19" | Arm Height 25" | Seat Depth 20"

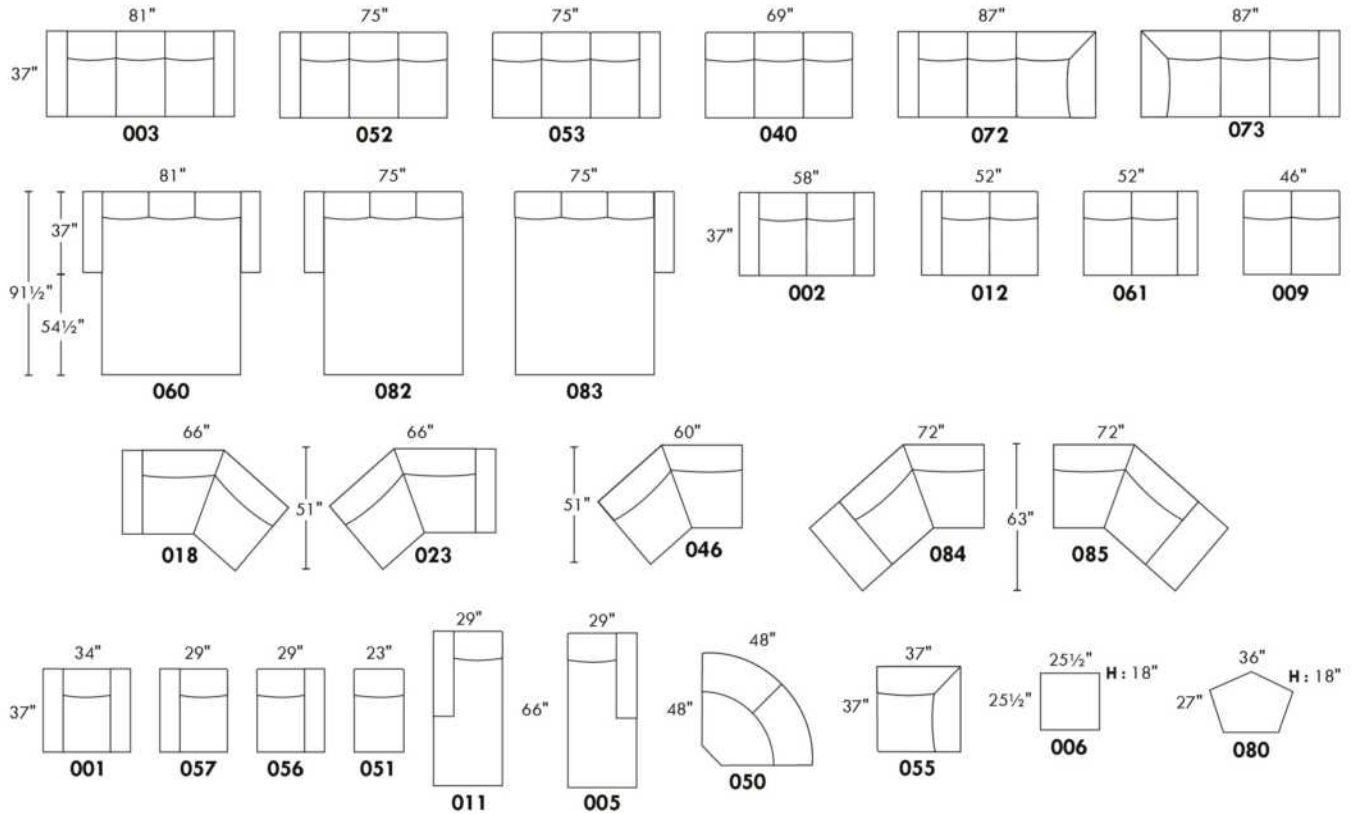

## CONFIGURATIONS

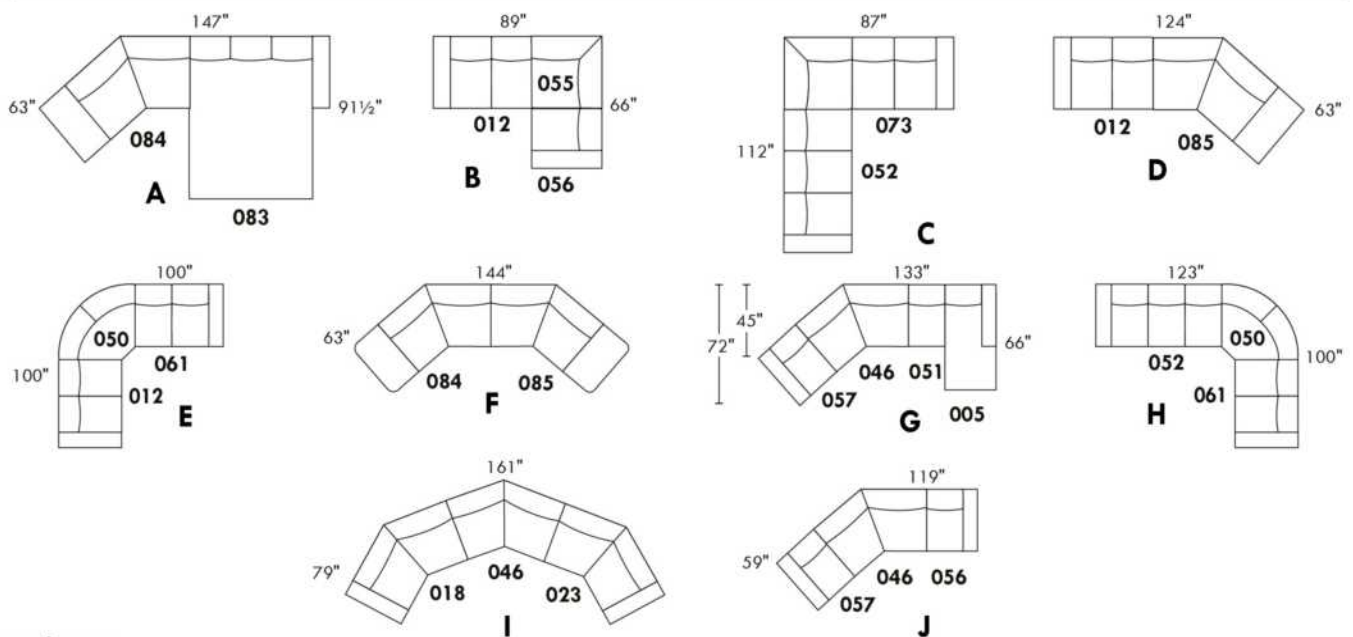

www.jaymar.ca

Toutes les dimensions indiquées sont au pouce près. Nos produits sont fabriqués à la main et des variations mineures peuvent survenir.  
 All dimensions indicated are to the nearest inch. Our product is hand-made and minor variations can occur.

## CDN Price List

### HUNTINGTON

Specify colour of legs LG58.

COMBO: Cover #2 on back and seat.

Upcharge for nails treatment on arms and front base:

Sectional: \$150    Sofa: \$125    Loveseat: \$100    Chair: \$75    Ottoman: \$50.

Sofa bed MATTRESS: Regular 4.5" mattress included. OPTIONAL 5" mattress:

-with coils and memory foam with gel: Double or Queen add \$100 or

-with high density foam and memory foam with gel: Double or Queen add \$150.

\*REMARK: In leather, armless end pieces are not fully upholstered.

| Description                       | L x D x H    | Leather |                       |  |  |                                  |                           | Fabric |          |           |
|-----------------------------------|--------------|---------|-----------------------|--|--|----------------------------------|---------------------------|--------|----------|-----------|
|                                   |              | 10      | 20<br>Madras<br>Softy | 30<br>Hugo<br>Fantasy<br>Illusion<br>Tucson<br>Utah<br>Vintage<br>Wild Laredo<br>Yukon | 40<br>Elegance<br>Princess<br>Santiago<br>Sensation<br>Sunset<br>Trina<br>Victoria | 50<br>Bull<br>Cassiope<br>Dublin | 60<br>Caress<br>Ultrasued | A      | B<br>COM | C<br>alta |
| 001 CHAIR                         | 42X37X35     | 1505    | 1590                  | 1675   | 1760   | 1845                             | 1930                      | 1030   | 1095     | 1160      |
| 002 LOVESEAT                      | 66X37X35     | 2050    | 2165                  | 2280   | 2395   | 2510                             | 2625                      | 1395   | 1480     | 1565      |
| 003 SOFA                          | 89X37X35     | 2495    | 2660                  | 2825   | 2990   | 3155                             | 3320                      | 1750   | 1845     | 1940      |
| 004 DOUBLE SOFA BED               | 83X37X35     | 2705    | 2875                  | 3045   | 3215   | 3385                             | 3555                      | 1980   | 2075     | 2170      |
| 005 LOUNGE CHAIR RIGHT ARM        | 33X66X35     | 1630    | 1725                  | 1820   | 1915   | 2010                             | 2105                      | 1140   | 1195     | 1250      |
| 006 OTTOMAN                       | 25.5X25.5X18 | 685     | 710                   | 735  | 760  | 785                              | 810                       | 550    | 570      | 590       |
| 009 ARMLESS LOVESEAT              | 46X37X35     | 1510    | 1625                  | 1740   | 1855   | 1970                             | 2085                      | 1180   | 1275     | 1370      |
| 011 LOUNGE CHAIR LEFT ARM         | 33X66X35     | 1630    | 1725                  | 1820   | 1915   | 2010                             | 2105                      | 1140   | 1195     | 1250      |
| 012 LOVESEAT LEFT ARM             | 56X37X35     | 1735    | 1850                  | 1965   | 2080   | 2195                             | 2310                      | 1305   | 1365     | 1425      |
| 015 SWIVEL CHAIR                  | 42X37X36     | 1600    | 1700                  | 1800   | 1900   | 2000                             | 2100                      | 1150   | 1215     | 1280      |
| 018 ANGULAR LOVESEAT LEFT ARM     | 65X55X35     | 1855    | 1985                  | 2115   | 2245   | 2375                             | 2505                      | 1235   | 1320     | 1405      |
| 023 ANGULAR LOVESEAT RIGHT ARM    | 65X55X35     | 1855    | 1985                  | 2115   | 2245   | 2375                             | 2505                      | 1235   | 1320     | 1405      |
| 040 ARMLESS SOFA                  | 69X37X35     | 1975    | 2130                  | 2285   | 2440   | 2595                             | 2750                      | 1540   | 1635     | 1730      |
| 045 ARMLESS LOVESEAT BUMPER RIGHT | 67X37X35     | 1735    | 1850                  | 1965   | 2080   | 2195                             | 2310                      | 1225   | 1310     | 1395      |
| 046 ARMLESS ANGULAR LOVESEAT      | 58X49X35     | 1635    | 1765                  | 1895   | 2025   | 2155                             | 2285                      | 1175   | 1270     | 1365      |
| 049 DOUBLE SOFA BED LEFT ARM      | 73X37X35     | 2420    | 2580                  | 2740   | 2900   | 3060                             | 3220                      | 1875   | 1980     | 2085      |
| 050 WEDGE                         | 48X48X35     | 1345    | 1445                  | 1545   | 1645   | 1745                             | 1845                      | 980    | 1040     | 1100      |
| 051 ARMLESS CHAIR                 | 23X37X35     | 955     | 1040                  | 1125   | 1210   | 1295                             | 1380                      | 890    | 945      | 1000      |
| 052 SOFA LEFT ARM                 | 79X37X35     | 2175    | 2335                  | 2495   | 2655   | 2815                             | 2975                      | 1645   | 1750     | 1855      |
| 053 SOFA RIGHT ARM                | 79X37X35     | 2175    | 2335                  | 2495   | 2655   | 2815                             | 2975                      | 1645   | 1750     | 1855      |
| 055 SQUARE CORNER                 | 37X37X35     | 1345    | 1445                  | 1545   | 1645   | 1745                             | 1845                      | 980    | 1040     | 1100      |
| 056 CHAIR RIGHT ARM               | 33X37X35     | 1160    | 1270                  | 1380   | 1490   | 1600                             | 1710                      | 945    | 1000     | 1055      |
| 057 CHAIR LEFT ARM                | 33X37X35     | 1160    | 1270                  | 1380   | 1490   | 1600                             | 1710                      | 945    | 1000     | 1055      |
| 059 DOUBLE SOFA BED RIGHT ARM     | 73X37X35     | 2420    | 2580                  | 2740   | 2900   | 3060                             | 3220                      | 1875   | 1980     | 2085      |

## CDN Price List

### HUNTINGTON

Specify colour of legs LG58.

COMBO: Cover #2 on back and seat.

Upcharge for nails treatment on arms and front base:

Sectional: \$150    Sofa: \$125    Loveseat: \$100    Chair: \$75    Ottoman: \$50.

Sofa bed MATTRESS: Regular 4.5" mattress included. OPTIONAL 5" mattress:

-with coils and memory foam with gel: Double or Queen add \$100 or

-with high density foam and memory foam with gel: Double or Queen add \$150.

\*REMARK: In leather, armless end pieces are not fully upholstered.

| Description                      | L x D x H  | Leather |                       |  |  |                                  |                           | Fabric |          |           |
|----------------------------------|------------|---------|-----------------------|--|--|----------------------------------|---------------------------|--------|----------|-----------|
|                                  |            | 10      | 20<br>Madras<br>Softy | 30<br>Hugo<br>Fantasy<br>Illusion<br>Tucson<br>Utah<br>Vintage<br>Wild Laredo<br>Yukon | 40<br>Elegance<br>Princess<br>Santiago<br>Sensation<br>Sunset<br>Trina<br>Victoria | 50<br>Bull<br>Cassiope<br>Dublin | 60<br>Caress<br>Ultrasued | A      | B<br>COM | C<br>alta |
| 060 QUEEN SOFA BED               | 89X37X35   | 2890    | 3050                  | 3210   | 3370   | 3530                             | 3690                      | 2130   | 2240     | 2350      |
| 061 LOVESEAT RIGHT ARM           | 56X37X35   | 1735    | 1850                  | 1965   | 2080   | 2195                             | 2310                      | 1305   | 1365     | 1425      |
| 072 SECTIONAL SOFA LEFT ARM      | 92X37X35   | 2535    | 2700                  | 2865   | 3030   | 3195                             | 3360                      | 1795   | 1885     | 1975      |
| 073 SECTIONAL SOFA RIGHT ARM     | 92X37X35   | 2535    | 2700                  | 2865   | 3030   | 3195                             | 3360                      | 1795   | 1885     | 1975      |
| 080 ANGULAR OTTOMAN              | 36X27X18   | 755     | 780                   | 805  | 830  | 855                              | 880                       | 645    | 670      | 695       |
| 082 QUEEN SOFA BED LEFT ARM      | 79X37X35   | 2535    | 2700                  | 2865   | 3030   | 3195                             | 3360                      | 2045   | 2145     | 2245      |
| 083 QUEEN SOFA BED RIGHT ARM     | 79X37X35   | 2535    | 2700                  | 2865   | 3030   | 3195                             | 3360                      | 2045   | 2145     | 2245      |
| 086 ARMLESS LOVESEAT BUMPER LEFT | 67X37X35   | 1735    | 1850                  | 1965   | 2080   | 2195                             | 2310                      | 1225   | 1310     | 1395      |
| <b>CONFIGURATIONS</b>            |            |         |                       |  |  |                                  |                           |        |          |           |
| A CONF. A (057-050-009-005)      | 127X81X35  | 5645    | 6065                  | 6485   | 6905   | 7325                             | 7745                      | 4245   | 4510     | 4775      |
| B CONF. B (012-050-083)          | 127X104X35 | 5615    | 5995                  | 6375   | 6755   | 7135                             | 7515                      | 4330   | 4550     | 4770      |
| C CONF. C (086-050-053)          | 127X115X35 | 5255    | 5630                  | 6005   | 6380   | 6755                             | 7130                      | 3850   | 4100     | 4350      |
| D CONF. D (086-055-045)          | 104X104X35 | 4815    | 5145                  | 5475   | 5805   | 6135                             | 6465                      | 3430   | 3660     | 3890      |
| E CONF. E (012-050-061)          | 104X104X35 | 4815    | 5145                  | 5475   | 5805   | 6135                             | 6465                      | 3590   | 3770     | 3950      |
| F CONF. F (072-053)              | 92X116X35  | 4710    | 5035                  | 5360   | 5685   | 6010                             | 6335                      | 3440   | 3635     | 3830      |
| G CONF. G (052-050-061)          | 127X104X35 | 5255    | 5630                  | 6005   | 6380   | 6755                             | 7130                      | 3930   | 4155     | 4380      |
| H CONF. H (052-050-056)          | 127X81X35  | 4680    | 5050                  | 5420   | 5790   | 6160                             | 6530                      | 3570   | 3790     | 4010      |

# HUNTINGTON



Hauteur complète 35" | Hauteur de siège 19" | Hauteur devant bras 25" | Profondeur d'assise 21"  
 Total Height 35" | Seat Height 19" | Arm Height 25" | Seat Depth 21"

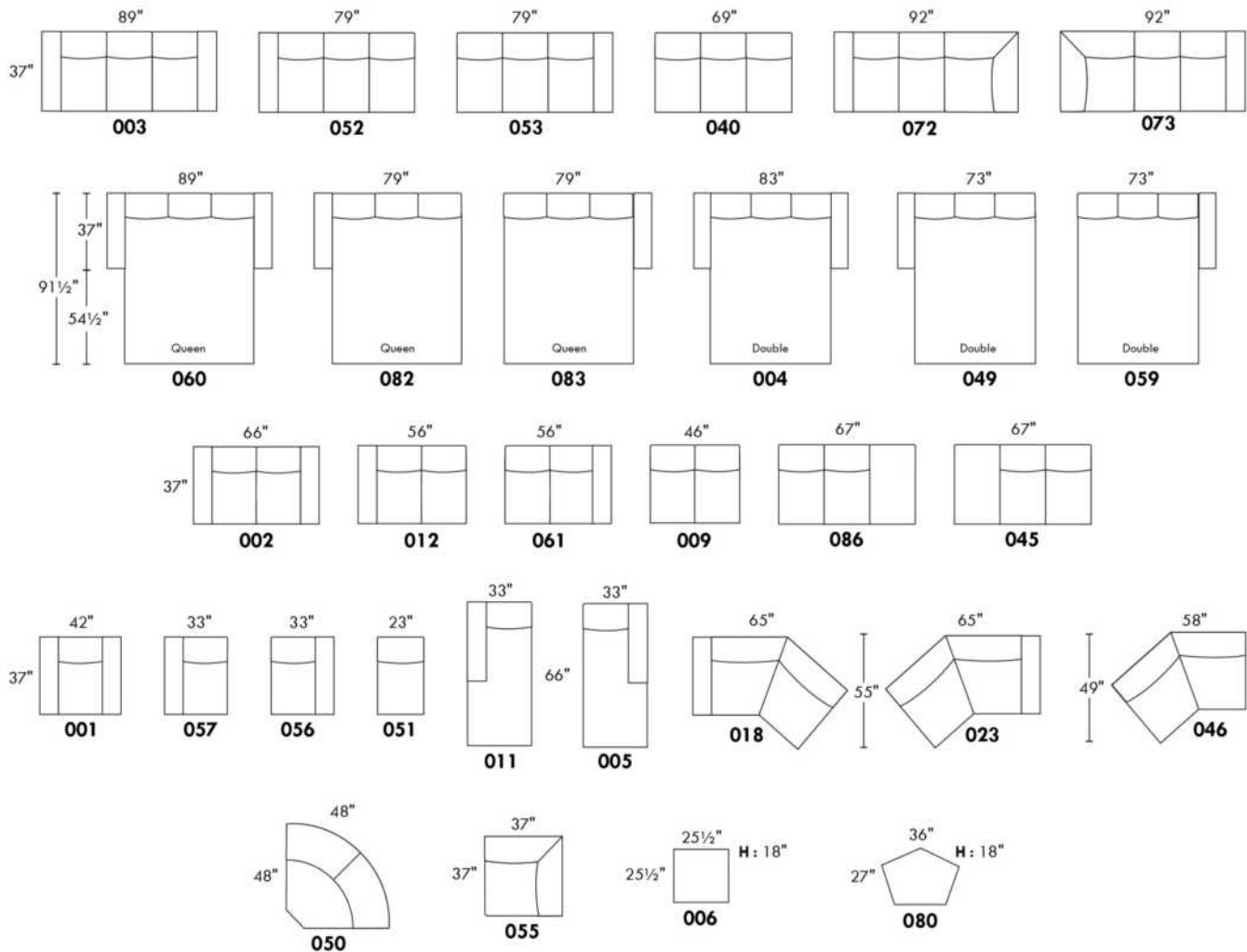

## CONFIGURATIONS

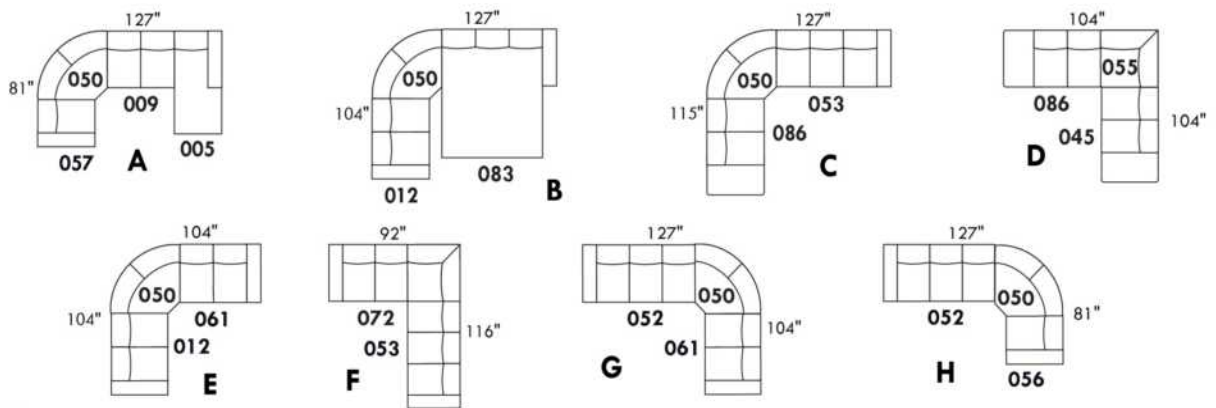

www.jaymar.ca

Toutes les dimensions indiquées sont au pouce près. Nos produits sont fabriqués à la main et des variations mineures peuvent survenir.  
 All dimensions indicated are to the nearest inch. Our product is hand-made and minor variations can occur.

## IBIZA

### FEATURES:

- Manual adjustable headrest on all items (2 on square corner & stationary on wedge).
- \*Wall hugger power recliners with full footrest (manual n/a).
- Power recliner lounge chair (manual n/a) with power headrest in option. Wall clearance 8" & front 5".
- Seat cushions with shaped foam + 1" layer of memory foam on top; arm with memory foam.
- Stitching: Small thread in fabric & large flat thread in leather.
- \*Excludes 043 & 163 chairs: Wall clearance 16"

Note: 2 recliner seats separated by a corner can not be opened at the same time. No recliner seats beside item #155.

### OPTIONS

- Battery Pack: Add \$160/ea.
- \*Motorized headrest: Add \$160 ea. (\*N/A on stationary items).
- Foam: Extra firm add \$15/seat.
- Choice of Large or Small 6" Arm: Leg on LARGE arm: LG103 wood or LG189 metal (Black or Chrome). SMALL Arm: LG08 wood or Metal: LG196 cyl. (Black or Chrome) or LG64 (sq). Specify colour.
- Seat Depth: 20" or \*22". \*22" seat depth N/A on chairs 043 & 163.
- 043 & 163 Chairs: with wood base (specify colour).

### HOME THEATRE Configurations

For Accessories, Cup holders & Configuration details, see Optima Home Theatre page attached.

Accessory Dock : \$35 ea.

Cup Holders: Metal: \$25 ea. | LED lighted Cup Holder: \$25 ea. | \*LED lighted Cup Holder with (1 or 2 motor) controls: \$40 ea.

\*LED Light strip under seat: \$25/seat.

| Description                        | L x D x H   | Leather |                       |  |  |                                  |                            | Fabric |          |           |
|------------------------------------|-------------|---------|-----------------------|--|--|----------------------------------|----------------------------|--------|----------|-----------|
|                                    |             | 10      | 20<br>Madras<br>Softy | 30<br>Hugo<br>Fantasy<br>Illusion<br>Tucson<br>Utah<br>Vintage<br>Wild Laredo<br>Yukon | 40<br>Elegance<br>Princess<br>Santiago<br>Sensation<br>Sunset<br>Trina<br>Victoria | 50<br>Bull<br>Cassiope<br>Dublin | 60<br>Caresse<br>Ultrasued | A      | B<br>COM | C<br>alta |
| 001 CHAIR                          | 43x40x33/40 | 1890    | 1980                  | 2070   | 2160   | 2250                             | 2340                       | 1535   | 1580     | 1625      |
| 002 LOVESEAT                       | 67x40x33/40 | 2700    | 2815                  | 2930   | 3045   | 3160                             | 3275                       | 2175   | 2250     | 2325      |
| 003 SOFA                           | 91x40x33/40 | 3265    | 3415                  | 3565   | 3715   | 3865                             | 4015                       | 2625   | 2715     | 2805      |
| 005 LOUNGE CHAIR RIGHT ARM         | 34x62x33/40 | 1765    | 1830                  | 1895   | 1960   | 2025                             | 2090                       | 1410   | 1470     | 1530      |
| 009 ARMLESS LOVESEAT               | 47x40x33/40 | 1895    | 1965                  | 2035   | 2105   | 2175                             | 2245                       | 1490   | 1570     | 1650      |
| 011 LOUNGE CHAIR LEFT ARM          | 34X62X33/40 | 1765    | 1830                  | 1895   | 1960   | 2025                             | 2090                       | 1410   | 1470     | 1530      |
| 012 LOVESEAT LEFT ARM              | 57x40x33/40 | 2320    | 2420                  | 2520   | 2620   | 2720                             | 2820                       | 1850   | 1925     | 2000      |
| 017 DOUBLE CHAIR                   | 51x40x33/40 | 1980    | 2080                  | 2180   | 2280   | 2380                             | 2480                       | 1600   | 1660     | 1720      |
| 021 APARTMENT SOFA NO ARM          | 61x40x33/40 | 2140    | 2240                  | 2340   | 2440   | 2540                             | 2640                       | 1670   | 1755     | 1840      |
| 040 ARMLESS SOFA                   | 71x40x33/40 | 2450    | 2565                  | 2680   | 2795   | 2910                             | 3025                       | 1950   | 2040     | 2130      |
| 041 RECLINING CHAIR LEFT ARM       | 34x40x33/40 | 1885    | 1960                  | 2035   | 2110   | 2185                             | 2260                       | 1605   | 1640     | 1675      |
| 042 RECLINING CHAIR RIGHT ARM      | 34x40x33/40 | 1885    | 1960                  | 2035   | 2110   | 2185                             | 2260                       | 1605   | 1640     | 1675      |
| 043 SWIVEL ROCKING RECLINING CHAIR | 30x34x42    | 2235    | 2345                  | 2455   | 2565   | 2675                             | 2785                       | 1875   | 1920     | 1965      |
| 044 RECLINER CHAIR                 | 44x40x33/40 | 2275    | 2365                  | 2455   | 2545   | 2635                             | 2725                       | 1920   | 1970     | 2020      |
| 045 ARMLESS LOVESEAT BUMPER RIGHT  | 68x40x33/40 | 2245    | 2340                  | 2435   | 2530   | 2625                             | 2720                       | 1785   | 1850     | 1915      |
| 050 WEDGE                          | 49x49x33    | 1645    | 1745                  | 1845   | 1945   | 2045                             | 2145                       | 1210   | 1270     | 1330      |

## IBIZA

### FEATURES:

- Manual adjustable headrest on all items (2 on square corner & stationary on wedge).
- \*Wall hugger power recliners with full footrest (manual n/a).
- Power recliner lounge chair (manual n/a) with power headrest in option. Wall clearance 8" & front 5".
- Seat cushions with shaped foam + 1" layer of memory foam on top; arm with memory foam.
- Stitching: Small thread in fabric & large flat thread in leather.
- \*Excludes 043 & 163 chairs: Wall clearance 16"

Note: 2 recliner seats separated by a corner can not be opened at the same time. No recliner seats beside item #155.

### OPTIONS

- Battery Pack: Add \$160/ea.
- \*Motorized headrest: Add \$160 ea. (\*N/A on stationary items).
- Foam: Extra firm add \$15/seat.
- Choice of Large or Small 6" Arm: Leg on LARGE arm: LG103 wood or LG189 metal (Black or Chrome). SMALL Arm: LG08 wood or Metal: LG196 cyl. (Black or Chrome) or LG64 (sq). Specify colour.
- Seat Depth: 20" or \*22". \*22" seat depth N/A on chairs 043 & 163.
- 043 & 163 Chairs: with wood base (specify colour).

### HOME THEATRE Configurations

For Accessories, Cup holders & Configuration details, see Optima Home Theatre page attached.

Accessory Dock : \$35 ea.

Cup Holders: Metal: \$25 ea. | LED lighted Cup Holder: \$25 ea. | \*LED lighted Cup Holder with (1 or 2 motor) controls: \$40 ea.

\*LED Light strip under seat: \$25/seat.

| Description                      | L x D x H     | Leather |                       |  |  |                                  |                            | Fabric |          |           |
|----------------------------------|---------------|---------|-----------------------|--|--|----------------------------------|----------------------------|--------|----------|-----------|
|                                  |               | 10      | 20<br>Madras<br>Softy | 30<br>Hugo<br>Fantasy<br>Illusion<br>Tucson<br>Utah<br>Vintage<br>Wild Laredo<br>Yukon | 40<br>Elegance<br>Princess<br>Santiago<br>Sensation<br>Sunset<br>Trina<br>Victoria | 50<br>Bull<br>Cassiope<br>Dublin | 60<br>Caresse<br>Ultrasued | A      | B<br>COM | C<br>alta |
| 051 ARMLESS CHAIR                | 23,5x40x33/40 | 1085    | 1135                  | 1185   | 1235   | 1285                             | 1335                       | 845    | 900      | 955       |
| 052 SOFA LEFT ARM                | 81x40x33/40   | 2870    | 3005                  | 3140   | 3275   | 3410                             | 3545                       | 2290   | 2385     | 2480      |
| 053 SOFA RIGHT ARM               | 81x40x33/40   | 2870    | 3005                  | 3140   | 3275   | 3410                             | 3545                       | 2290   | 2385     | 2480      |
| 055 SQUARE CORNER                | 44x44x33/40   | 1915    | 2010                  | 2105   | 2200   | 2295                             | 2390                       | 1510   | 1565     | 1620      |
| 056 CHAIR RIGHT ARM              | 34x40x33/40   | 1510    | 1575                  | 1640   | 1705   | 1770                             | 1835                       | 1200   | 1260     | 1320      |
| 057 CHAIR LEFT ARM               | 34x40x33/40   | 1510    | 1575                  | 1640   | 1705   | 1770                             | 1835                       | 1200   | 1260     | 1320      |
| 061 LOVESEAT RIGHT ARM           | 57x40x33/40   | 2320    | 2420                  | 2520   | 2620   | 2720                             | 2820                       | 1850   | 1925     | 2000      |
| 071 ARMLESS RECLINING CHAIR      | 23,5x40x33/40 | 1470    | 1525                  | 1580   | 1635   | 1690                             | 1745                       | 1250   | 1310     | 1370      |
| 086 ARMLESS LOVESEAT BUMPER LEFT | 68x40x33/40   | 2245    | 2340                  | 2435   | 2530   | 2625                             | 2720                       | 1785   | 1850     | 1915      |
| 088 ARMLESS CHAIR BUMPER LEFT    | 45x40x33/40   | 1440    | 1535                  | 1630   | 1725   | 1820                             | 1915                       | 1130   | 1165     | 1200      |
| 089 ARMLESS CHAIR BUMPER RIGHT   | 45x40x33/40   | 1440    | 1535                  | 1630   | 1725   | 1820                             | 1915                       | 1130   | 1165     | 1200      |
| 095 APARTMENT SOFA               | 81x40x33/40   | 2940    | 3085                  | 3230   | 3375   | 3520                             | 3665                       | 2350   | 2445     | 2540      |
| 096 APARTMENT SOFA LEFT ARM      | 71x40x33/40   | 2570    | 2680                  | 2790   | 2900   | 3010                             | 3120                       | 2020   | 2110     | 2200      |
| 097 APARTMENT SOFA RIGHT ARM     | 71x40x33/40   | 2570    | 2680                  | 2790   | 2900   | 3010                             | 3120                       | 2020   | 2110     | 2200      |
| 124 STORAGE OTTOMAN              | 30x22x17      | 745     | 765                   | 785  | 805  | 825                              | 845                        | 650    | 670      | 690       |
| 138 STRAIGHT ARM                 | 10x36x24.5    | 415     | 450                   | 485  | 520  | 555                              | 590                        | 350    | 365      | 380       |

## IBIZA

**FEATURES:**

- Manual adjustable headrest on all items (2 on square corner & stationary on wedge).
- \*Wall hugger power recliners with full footrest (manual n/a).
- Power recliner lounge chair (manual n/a) with power headrest in option. Wall clearance 8" & front 5".
- Seat cushions with shaped foam + 1" layer of memory foam on top; arm with memory foam.
- Stitching: Small thread in fabric & large flat thread in leather.
- \*Excludes 043 & 163 chairs: Wall clearance 16"

Note: 2 recliner seats separated by a corner can not be opened at the same time. No recliner seats beside item #155.

**OPTIONS**

- Battery Pack: Add \$160/ea.
- \*Motorized headrest: Add \$160 ea. (\*N/A on stationary items).
- Foam: Extra firm add \$15/seat.
- Choice of Large or Small 6" Arm: Leg on LARGE arm: LG103 wood or LG189 metal (Black or Chrome). SMALL Arm: LG08 wood or Metal: LG196 cyl. (Black or Chrome) or LG64 (sq). Specify colour.
- Seat Depth: 20" or \*22". \*22" seat depth N/A on chairs 043 & 163.
- 043 & 163 Chairs: with wood base (specify colour).

**HOME THEATRE Configurations**

For Accessories, Cup holders & Configuration details, see Optima Home Theatre page attached.

Accessory Dock : \$35 ea.

Cup Holders: Metal: \$25 ea. | LED lighted Cup Holder: \$25 ea. | \*LED lighted Cup Holder with (1 or 2 motor) controls: \$40 ea.

\*LED Light strip under seat: \$25/seat.

| Description                            | L x D x H     | Leather |                       |  |  |                                  |                           | Fabric |          |           |
|--|---------------|---------|-----------------------|--|--|----------------------------------|---------------------------|--------|----------|-----------|
|  |               | 10      | 20<br>Madras<br>Softy | 30<br>Hugo<br>Fantasy<br>Illusion<br>Tucson<br>Utah<br>Vintage<br>Wild Laredo<br>Yukon | 40<br>Elegance<br>Princess<br>Santiago<br>Sensation<br>Sunset<br>Trina<br>Victoria | 50<br>Bull<br>Cassiope<br>Dublin | 60<br>Caress<br>Ultrasued | A      | B<br>COM | C<br>alta |
| 155 SMALL SQUARE CORNER                | 40x40x33/40   | 1915    | 2010                  | 2105   | 2200   | 2295                             | 2390                      | 1510   | 1565     | 1620      |
| 159 WEDGE STORAGE                      | 11/27x36x24.5 | 745     | 775                   | 805  | 835  | 865                              | 895                       | 585    | 600      | 615       |
| 160 STRAIGHT STORAGE                   | 11x36x24.5    | 720     | 745                   | 770  | 795  | 820                              | 845                       | 550    | 570      | 590       |
| 163 DBL SWIVEL ROCKING RECLINER CHAIR  | 33x34x42      | 2290    | 2410                  | 2530   | 2650   | 2770                             | 2890                      | 1880   | 1930     | 1980      |
| 165 DOUBLE RECLINING CHAIR             | 50x40x33/40   | 2375    | 2475                  | 2575   | 2675   | 2775                             | 2875                      | 2000   | 2065     | 2130      |
| 167 APARTMENT SOFA NO ARM BUMPER LEFT  | 82x40x33/40   | 2490    | 2620                  | 2750   | 2880   | 3010                             | 3140                      | 1960   | 2045     | 2130      |
| 168 APARTMENT SOFA NO ARM BUMPER RIGHT | 82x40x33/40   | 2490    | 2620                  | 2750   | 2880   | 3010                             | 3140                      | 1960   | 2045     | 2130      |
| 169 DOUBLE RECLINING CHAIR LEFT ARM    | 41x40x33/40   | 1990    | 2070                  | 2150   | 2230   | 2310                             | 2390                      | 1670   | 1750     | 1830      |
| 170 DOUBLE RECLINING CHAIR RIGHT ARM   | 41x40x33/40   | 1990    | 2070                  | 2150   | 2230   | 2310                             | 2390                      | 1670   | 1750     | 1830      |
| 171 ARMLESS DOUBLE RECLINING CHAIR     | 30,5x40x33/40 | 1575    | 1625                  | 1675   | 1725   | 1775                             | 1825                      | 1320   | 1380     | 1440      |
| 173 DOUBLE LOUNGE CHAIR LEFT ARM       | 41x62x33/40   | 1915    | 2005                  | 2095   | 2185   | 2275                             | 2365                      | 1535   | 1615     | 1695      |
| 174 DOUBLE LOUNGE CHAIR RIGHT ARM      | 41x62x33/40   | 1915    | 2005                  | 2095   | 2185   | 2275                             | 2365                      | 1535   | 1615     | 1695      |
| 175 DOUBLE CHAIR LEFT ARM              | 41x40x33/40   | 1590    | 1680                  | 1770   | 1860   | 1950                             | 2040                      | 1285   | 1350     | 1415      |
| 176 DOUBLE CHAIR RIGHT ARM             | 41x40x33/40   | 1590    | 1680                  | 1770   | 1860   | 1950                             | 2040                      | 1285   | 1350     | 1415      |
| 177 ARMLESS DOUBLE CHAIR               | 30,5x40x33/40 | 1185    | 1250                  | 1315   | 1380   | 1445                             | 1510                      | 915    | 970      | 1025      |
| 178 ARMLESS DOUBLE CHAIR BUMPER LEFT   | 52x40x33/40   | 1545    | 1625                  | 1705   | 1785   | 1865                             | 1945                      | 1230   | 1290     | 1350      |



## IBIZA

### FEATURES:

- Manual adjustable headrest on all items (2 on square corner & stationary on wedge).
- \*Wall hugger power recliners with full footrest (manual n/a).
- Power recliner lounge chair (manual n/a) with power headrest in option. Wall clearance 8" & front 5".
- Seat cushions with shaped foam + 1" layer of memory foam on top; arm with memory foam.
- Stitching: Small thread in fabric & large flat thread in leather.
- \*Excludes 043 & 163 chairs: Wall clearance 16"

Note: 2 recliner seats separated by a corner can not be opened at the same time. No recliner seats beside item #155.

### OPTIONS

- Battery Pack: Add \$160/ea.
- \*Motorized headrest: Add \$160 ea. (\*N/A on stationary items).
- Foam: Extra firm add \$15/seat.
- Choice of Large or Small 6" Arm: Leg on LARGE arm: LG103 wood or LG189 metal (Black or Chrome). SMALL Arm: LG08 wood or Metal: LG196 cyl. (Black or Chrome) or LG64 (sq). Specify colour.
- Seat Depth: 20" or \*22". \*22" seat depth N/A on chairs 043 & 163.
- 043 & 163 Chairs: with wood base (specify colour).

### HOME THEATRE Configurations

For Accessories, Cup holders & Configuration details, see Optima Home Theatre page attached.

Accessory Dock : \$35 ea.

Cup Holders: Metal: \$25 ea. | LED lighted Cup Holder: \$25 ea. | \*LED lighted Cup Holder with (1 or 2 motor) controls: \$40 ea.

\*LED Light strip under seat: \$25/seat.

| Description                            | L x D x H       | Leather |                       |  |  |                                  |                           | Fabric |          |           |
|--|-----------------|---------|-----------------------|--|--|----------------------------------|---------------------------|--------|----------|-----------|
|  |                 | 10      | 20<br>Madras<br>Softy | 30<br>Hugo<br>Fantasy<br>Illusion<br>Tucson<br>Utah<br>Vintage<br>Wild Laredo<br>Yukon | 40<br>Elegance<br>Princess<br>Santiago<br>Sensation<br>Sunset<br>Trina<br>Victoria | 50<br>Bull<br>Cassiope<br>Dublin | 60<br>Caress<br>Ultrasued | A      | B<br>COM | C<br>alta |
| 179 ARMLESS DOUBLE CHAIR BUMPER RIGHT  | 52x40x33/40     | 1545    | 1625                  | 1705   | 1785   | 1865                             | 1945                      | 1230   | 1290     | 1350      |
| 186 ARMLESS LOVESEAT BUMPER STORAGE-L  | 68x40x33/40     | 2420    | 2500                  | 2580   | 2660   | 2740                             | 2820                      | 1950   | 2015     | 2080      |
| 187 ARMLESS LOVESEAT BUMPER STORAGE-R  | 68x40x33/40     | 2420    | 2500                  | 2580   | 2660   | 2740                             | 2820                      | 1950   | 2015     | 2080      |
| 188 ARMLESS CHAIR BUMPER STORAGE-L     | 45x40x33/40     | 1600    | 1690                  | 1780   | 1870   | 1960                             | 2050                      | 1295   | 1330     | 1365      |
| 189 ARMLESS CHAIR BUMPER STORAGE-R     | 45x40x33/40     | 1600    | 1690                  | 1780   | 1870   | 1960                             | 2050                      | 1295   | 1330     | 1365      |
| 190 SMALL WEDGE STORAGE                | 11/21x36x24.5   | 720     | 745                   | 770  | 795  | 820                              | 845                       | 550    | 570      | 590       |
| 221 ARMLESS DBL CHAIR BUMPER STORAGE-L | 52x40x33/40     | 1705    | 1790                  | 1875   | 1960   | 2045                             | 2130                      | 1390   | 1450     | 1510      |
| 222 ARMLESS DBL CHAIR BUMPER STORAGE-R | 52x40x33/40     | 1705    | 1790                  | 1875   | 1960   | 2045                             | 2130                      | 1390   | 1450     | 1510      |
| 223 APT SOFA NO ARM BUMPER STORAGE-L   | 82x40x33/40     | 2655    | 2785                  | 2915   | 3045   | 3175                             | 3305                      | 2120   | 2215     | 2310      |
| 224 APT SOFA NO ARM BUMPER STORAGE-R   | 82x40x33/40     | 2655    | 2785                  | 2915   | 3045   | 3175                             | 3305                      | 2120   | 2215     | 2310      |
| 236 RECLINING LOUNGE CHAIR LEFT ARM    | 34x62x33/40     | 2160    | 2225                  | 2290   | 2355   | 2420                             | 2485                      | 1820   | 1880     | 1940      |
| 237 RECLINING LOUNGE CHAIR RIGHT ARM   | 34x62x33/40     | 2160    | 2225                  | 2290   | 2355   | 2420                             | 2485                      | 1820   | 1880     | 1940      |
| 238 RECLINING DBL LOUNGE CHAIR L-ARM   | 41x62x33/40     | 2315    | 2405                  | 2495   | 2585   | 2675                             | 2765                      | 1940   | 2020     | 2100      |
| 239 RECLINING DBL LOUNGE CHAIR R-ARM   | 41x62x33/40     | 2315    | 2405                  | 2495   | 2585   | 2675                             | 2765                      | 1940   | 2020     | 2100      |
| V51 WINE GLASS HOLDER                  | 3.5 x 5.5 x 6.5 | 35      | 35                    | 35   | 35   | 35                               | 35                        | 35     | 35       | 35        |
| V52 PLASTIC SWIVEL TRAY                | 13 3/8 x 9 5/8  | 35      | 35                    | 35   | 35   | 35                               | 35                        | 35     | 35       | 35        |

## IBIZA

### FEATURES:

- Manual adjustable headrest on all items (2 on square corner & stationary on wedge).
- \*Wall hugger power recliners with full footrest (manual n/a).
- Power recliner lounge chair (manual n/a) with power headrest in option. Wall clearance 8" & front 5".
- Seat cushions with shaped foam + 1" layer of memory foam on top; arm with memory foam.
- Stitching: Small thread in fabric & large flat thread in leather.
- \*Excludes 043 & 163 chairs: Wall clearance 16"

Note: 2 recliner seats separated by a corner can not be opened at the same time. No recliner seats beside item #155.

### OPTIONS

- Battery Pack: Add \$160/ea.
- \*Motorized headrest: Add \$160 ea. (\*N/A on stationary items).
- Foam: Extra firm add \$15/seat.
- Choice of Large or Small 6" Arm: Leg on LARGE arm: LG103 wood or LG189 metal (Black or Chrome). SMALL Arm: LG08 wood or Metal: LG196 cyl. (Black or Chrome) or LG64 (sq). Specify colour.
- Seat Depth: 20" or \*22". \*22" seat depth N/A on chairs 043 & 163.
- 043 & 163 Chairs: with wood base (specify colour).

### HOME THEATRE Configurations

For Accessories, Cup holders & Configuration details, see Optima Home Theatre page attached.

Accessory Dock : \$35 ea.

Cup Holders: Metal: \$25 ea. | LED lighted Cup Holder: \$25 ea. | \*LED lighted Cup Holder with (1 or 2 motor) controls: \$40 ea.

\*LED Light strip under seat: \$25/seat.

| Description                 | L x D x H          | Leather |                       |  |  |                                  |                           | Fabric |          |           |
|-----------------------------|--------------------|---------|-----------------------|--|--|----------------------------------|---------------------------|--------|----------|-----------|
|                             |                    | 10      | 20<br>Madras<br>Softy | 30<br>Hugo<br>Fantasy<br>Illusion<br>Tucson<br>Utah<br>Vintage<br>Wild Laredo<br>Yukon | 40<br>Elegance<br>Princess<br>Santiago<br>Sensation<br>Sunset<br>Trina<br>Victoria | 50<br>Bull<br>Cassiope<br>Dublin | 60<br>Caress<br>Ultrasued | A      | B<br>COM | C<br>alta |
| V53 WOOD SWIVEL TRAY        | 19 x 10            | 60      | 60                    | 60   | 60   | 60                               | 60                        | 60     | 60       | 60        |
| V54 TABLET HOLDER           | 4.5 x 8 x 10       | 40      | 40                    | 40   | 40   | 40                               | 40                        | 40     | 40       | 40        |
| V55 LED LAMP                | 1.5x5x14 plié/bent | 35      | 35                    | 35   | 35   | 35                               | 35                        | 35     | 35       | 35        |
| <b>CONFIGURATIONS</b>       |                    |         |                       |  |  |                                  |                           |        |          |           |
| _A CONFIG (169-170)         | 82X40X40           | 3980    | 4140                  | 4300   | 4460   | 4620                             | 4780                      | 3340   | 3500     | 3660      |
| _B CONFIG (169-171-174)     | 113X62X40          | 5480    | 5700                  | 5920   | 6140   | 6360                             | 6580                      | 4525   | 4745     | 4965      |
| _C CONFIG (096-055-171-170) | 115X115X40         | 8050    | 8385                  | 8720   | 9055   | 9390                             | 9725                      | 6520   | 6805     | 7090      |
| _D CONFIG (169-171-055-179) | 115X96X40          | 7025    | 7330                  | 7635   | 7940   | 8245                             | 8550                      | 5730   | 5985     | 6240      |
| _J CONFIG (041-042)         | 68X40X40           | 3770    | 3920                  | 4070   | 4220   | 4370                             | 4520                      | 3210   | 3280     | 3350      |
| _K CONFIG (041-071-005)     | 92X62X40           | 5120    | 5315                  | 5510   | 5705   | 5900                             | 6095                      | 4265   | 4420     | 4575      |
| _L CONFIG (012-055-071-042) | 102X102X40         | 7590    | 7915                  | 8240   | 8565   | 8890                             | 9215                      | 6215   | 6440     | 6665      |
| _M CONFIG (041-071-055-089) | 102X89X40          | 6710    | 7030                  | 7350   | 7670   | 7990                             | 8310                      | 5495   | 5680     | 5865      |



# IBIZA

**OPTIMA**  
Collection

**Jaymar**

Conçu et fabriqué fièrement au Canada  
Proudly designed and made in Canada

Nos produits sont fabriqués à la main et  
des variations mineures peuvent survenir

Our product is hand-made and minor variations can occur.

## SPECIFICATIONS

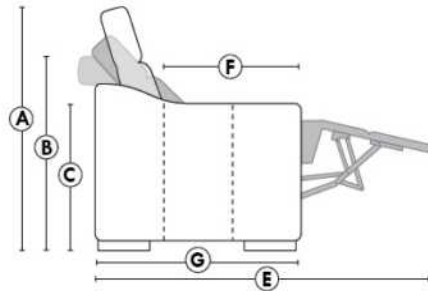

- Appui-tête levé Headrest up
- Appui-tête baissé Headrest down
- Complètement incliné Fully reclined

- A** Hauteur complète 40" Total Height
- B** Hauteur appui-tête baissé 33" Height headrest down
- C** Hauteur du bras 24,5" Arm Height
- D** Hauteur du siège 19,5" Seat height
- E** Profondeur inclinée 65" Depth fully reclined
- F** Profondeur d'assise 20"ou/ou 22" Seat depth
- G** Profondeur appui-tête monté 37,5" Depth with headrest up

## BRAS | ARMS

Option de bras:  
Bras Régulier Large 10" ou Petit bras 6"

Arm option  
Regular arm Large 10" or Small arm 6"

Contrôle de l'inclinaison situé à l'intérieur du bras  
Recliner control located on the inside of the arm.

Option d'accessoires disponible sur  
le bras régulier seulement  
Accessories option, available on Regular arms ONLY.

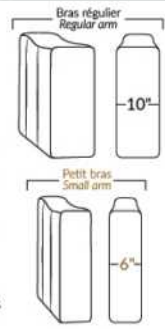

## FAUTEUIL BERÇANT PIVOTANT INCLINABLE SWIVEL ROCKING MOTION CHAIR

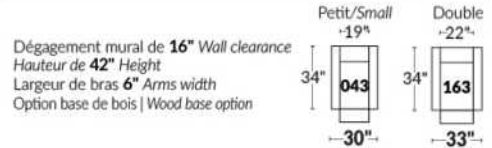

## SIÈGE 23" DE LARGE | 23" SEAT WIDTH

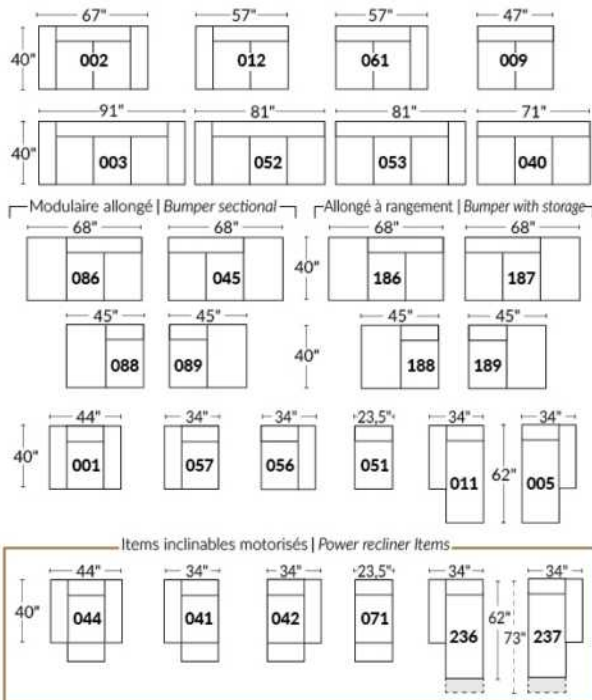

## SIÈGE 30" DE LARGE | 30" SEAT WIDTH

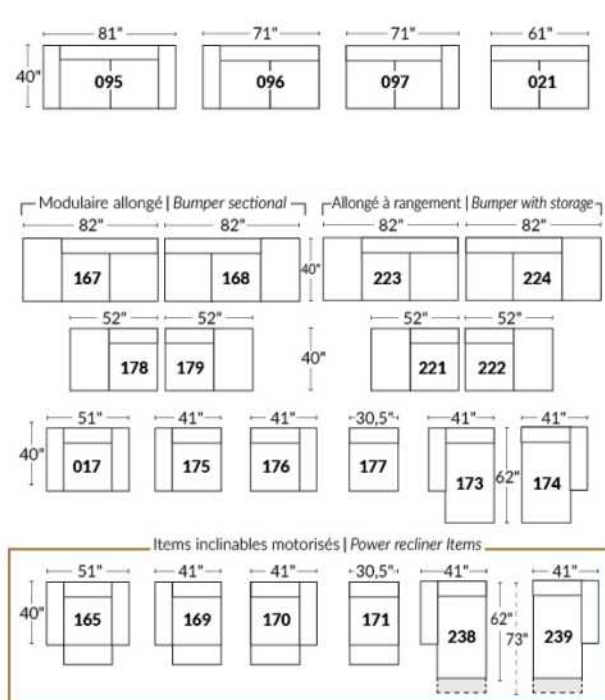

### Autres | Others

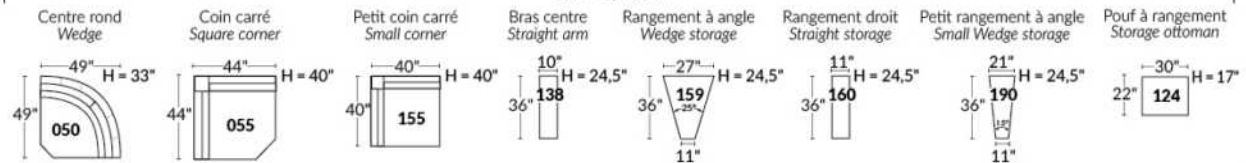

### EXEMPLE 23" EXAMPLE

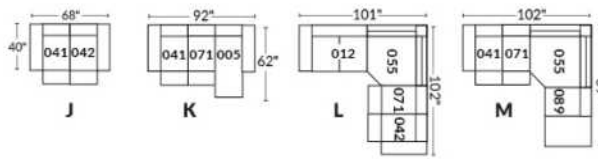

### EXEMPLE 30" EXAMPLE

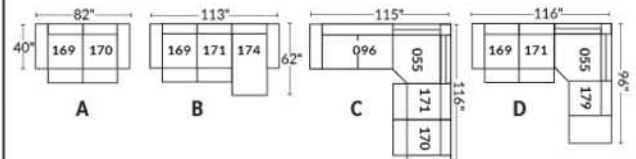

\*Available on certain models and on large arms ONLY.

### OPTIONS CUP HOLDERS

#### METAL



Silver



Matte Black



Brown

#### ILLUMINATED

1.



LED Lighted Cup holder

2.



LED Lighted Cup holder with Single Motor Control, USB Port and LED Base rail

3.



LED Lighted Cup holder with Dual Motor Control, USB Port and LED Base rail

Our illuminated one or two-control cup holders are compatible with LED lights under the seat. You can control the light on the cup holder. The 2 motor cup holder has a reset (home) button control to close your recliner back to its starting position.

#### LED Light under seat (Optional)

Available only in configurations with a minimum of 1 illuminated motorized cup holder with control buttons. The "light" button will control the opening and closing of the light.

For cup holder prices see description section of the Optima model price list.

Please provide us with a drawing of your configuration which indicates the cup holder type and its positioning.

#### Cup holder with controller:

It is important to specify the placement of the cups; on left arm or right arm and which recliner they will control. If you have a row of several seats with cup holders, by default, the controls will be on the left arms and on the right arm for the last outer chair.

#### EXAMPLE A:

041-169: Controller and cup holder on the left arm

071-171: hidden touch sensor buttons on side of seat

042-170: Controller and cup holder on right arm



#### EXAMPLE B:

071-171: These two items can be connected to a smart cup holder which will control the recliner. You must then use one of these items: 138,159, 160 and 190



#### Informations about headrest, controller on reclining seat

#### WITH illuminated cup holder

If you have a **stationary item**, you will have cup holder N°1.

If you have a recliner chair with a **manual headrest**, you will have the cup holder N°2.

If you have a recliner chair with an **electric headrest**, you will have cup holder N°3.

#### Without cup holder and with a reclining seat

If you have a recliner with a **manual headrest** you will have the touch sensor button control on the side of the seat.

If you have a recliner with an **electric headrest** you will have a dual push button controller with USB port on the arm.

If you have an **armless recliner**, you will have the hidden touch sensor button control.



Hidden touch sensor



Dual push button

# OPTIMA

## HOME THEATRE Configurations

\*Available on certain models and on large arms ONLY.

OPTIONS

### ACCESSORIES

Accessory Dock



V51 Wine Glass Holder



V52 Plastic Swivel Tray Table



V53 Wood Swivel tray Table  
(Choice of 8 colors)



Specify on which arm (left or right) the tray table will be installed.

V54 Tablet Holder



V55 LED Lamp



(For Accessory Dock price, see description section of the Optima model price list and for Accessory item prices, see at very end of the price list)

### Items 138-159-160-190 and large arm.

Accessory docks and cups are Optional. \*Not available on small arms\*

Please specify on which arms you want the accessory docks and cup holders.

NB: Item 138-159-160-190 are unfinished on the sides, must be used between 2 seats.

Each storage item has 2 USB ports and one electrical outlet inside the storage.



### SUGGESTED CONFIGURATIONS

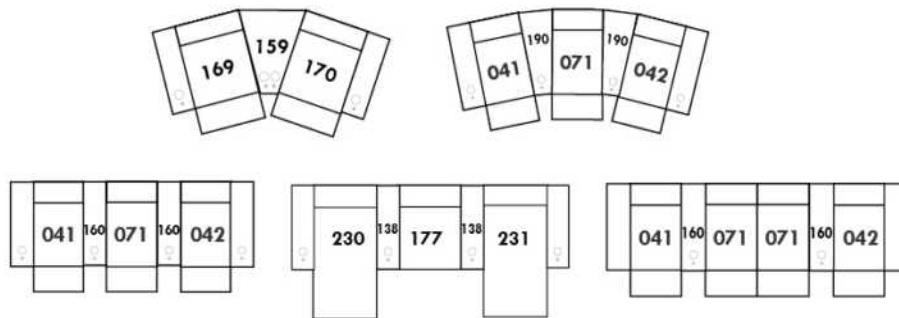



## JAMES

Features: Manual adjustable headrest included with all items (2 on square corner). Stitching: Small thread in fabric & large flat thread in leather. Memory foam in seat cushions.

NOTE: 2 recliner seats SEPARATED by a SQUARE CORNER or TABLE cannot be opened at the same time.

OPTIONS - Provide SKETCH of your config:

Small 6" Arm at same price.

Leg on LARGE arm: LG189 metal (Black or Chrome) or LG103 wood. SMALL arm: L64 metal or LG08 wood (specify colour).

Table (154): Specify colour of wood table top.

043 & 163 Chairs: with wood base (specify colour).

Accessories: Anchorage \$35 ea. | Plastic Swivel tray & Wine Glass holder \$35 ea. | Wood Swivel tray \$60 ea. | Tablet holder \$40 ea. & LED Lamp \$35 ea.

\*\*MANUAL RECLINER N/A.\*\* Motorized mechanism included in price of recliner chair items. For Battery Pack add \$160/mechanism.

| Description                        | L x D x H     | Leather |                       |  |  |                                  |                           | Fabric |          |           |
|------------------------------------|---------------|---------|-----------------------|--|--|----------------------------------|---------------------------|--------|----------|-----------|
|                                    |               | 10      | 20<br>Madras<br>Softy | 30<br>Hugo<br>Fantasy<br>Illusion<br>Tucson<br>Utah<br>Vintage<br>Wild Laredo<br>Yukon | 40<br>Elegance<br>Princess<br>Santiago<br>Sensation<br>Sunset<br>Trina<br>Victoria | 50<br>Bull<br>Cassiope<br>Dublin | 60<br>Caress<br>Ultrasued | A      | B<br>COM | C<br>alta |
| 001 CHAIR                          | 44x40x30/39   | 1775    | 1870                  | 1965   | 2060   | 2155                             | 2250                      | 1395   | 1455     | 1515      |
| 002 LOVESEAT                       | 67x40x30/39   | 2530    | 2660                  | 2790   | 2920   | 3050                             | 3180                      | 2010   | 2080     | 2150      |
| 003 SOFA                           | 91x40x30/39   | 3050    | 3185                  | 3320   | 3455   | 3590                             | 3725                      | 2395   | 2490     | 2585      |
| 005 LOUNGE CHAIR RIGHT ARM         | 34x62x30/39   | 1600    | 1680                  | 1760   | 1840   | 1920                             | 2000                      | 1250   | 1315     | 1380      |
| 009 ARMLESS LOVESEAT               | 47x40x30/39   | 1800    | 1875                  | 1950   | 2025   | 2100                             | 2175                      | 1390   | 1475     | 1560      |
| 011 LOUNGE CHAIR LEFT ARM          | 34x62x30/39   | 1600    | 1680                  | 1760   | 1840   | 1920                             | 2000                      | 1250   | 1315     | 1380      |
| 012 LOVESEAT LEFT ARM              | 57x40x30/39   | 2155    | 2250                  | 2345   | 2440   | 2535                             | 2630                      | 1670   | 1745     | 1820      |
| 017 DOUBLE CHAIR                   | 51x40x30/39   | 1875    | 1975                  | 2075   | 2175   | 2275                             | 2375                      | 1485   | 1540     | 1595      |
| 021 APARTMENT SOFA NO ARM          | 61x40x30/39   | 2050    | 2145                  | 2240   | 2335   | 2430                             | 2525                      | 1580   | 1660     | 1740      |
| 040 ARMLESS SOFA                   | 71x40x30/39   | 2315    | 2420                  | 2525   | 2630   | 2735                             | 2840                      | 1800   | 1895     | 1990      |
| 041 RECLINING CHAIR LEFT ARM       | 34x40x30/39   | 1745    | 1815                  | 1885   | 1955   | 2025                             | 2095                      | 1475   | 1510     | 1545      |
| 042 RECLINING CHAIR RIGHT ARM      | 34x40x30/39   | 1745    | 1815                  | 1885   | 1955   | 2025                             | 2095                      | 1475   | 1510     | 1545      |
| 043 SWIVEL ROCKING RECLINING CHAIR | 30x34x42"     | 2150    | 2245                  | 2340   | 2435   | 2530                             | 2625                      | 1790   | 1835     | 1880      |
| 044 RECLINER CHAIR                 | 44x40x30/39   | 2130    | 2225                  | 2320   | 2415   | 2510                             | 2605                      | 1780   | 1825     | 1870      |
| 045 ARMLESS LOVESEAT BUMPER RIGHT  | 68x40x30/39   | 2100    | 2210                  | 2320   | 2430   | 2540                             | 2650                      | 1630   | 1710     | 1790      |
| 051 ARMLESS CHAIR                  | 23,5x40x30/39 | 1040    | 1100                  | 1160   | 1220   | 1280                             | 1340                      | 795    | 855      | 915       |
| 052 SOFA LEFT ARM                  | 81x40x30/39   | 2675    | 2805                  | 2935   | 3065   | 3195                             | 3325                      | 2085   | 2180     | 2275      |
| 053 SOFA RIGHT ARM                 | 81x40x30/39   | 2675    | 2805                  | 2935   | 3065   | 3195                             | 3325                      | 2085   | 2180     | 2275      |
| 055 SQUARE CORNER                  | 44x44x30/39   | 1865    | 1965                  | 2065   | 2165   | 2265                             | 2365                      | 1460   | 1515     | 1570      |
| 056 CHAIR RIGHT ARM                | 34x40x30/39   | 1390    | 1465                  | 1540   | 1615   | 1690                             | 1765                      | 1085   | 1135     | 1185      |





## JAMES

Features: Manual adjustable headrest included with all items (2 on square corner). Stitching: Small thread in fabric & large flat thread in leather. Memory foam in seat cushions.

NOTE: 2 recliner seats SEPARATED by a SQUARE CORNER or TABLE cannot be opened at the same time.

OPTIONS - Provide SKETCH of your config:

Small 6" Arm at same price.

Leg on LARGE arm: LG189 metal (Black or Chrome) or LG103 wood. SMALL arm: L64 metal or LG08 wood (specify colour).

Table (154): Specify colour of wood table top.

043 & 163 Chairs: with wood base (specify colour).

Accessories: Anchorage \$35 ea. | Plastic Swivel tray & Wine Glass holder \$35 ea. | Wood Swivel tray \$60 ea. | Tablet holder \$40 ea. & LED Lamp \$35 ea.

\*\*MANUAL RECLINER N/A.\*\* Motorized mechanism included in price of recliner chair items. For Battery Pack add \$160/mechanism.

| Description                            | L x D x H     | Leather |                       |  |  |                                  |                           | Fabric |          |           |
|--|---------------|---------|-----------------------|--|--|----------------------------------|---------------------------|--------|----------|-----------|
|  |               | 10      | 20<br>Madras<br>Softy | 30<br>Hugo<br>Fantasy<br>Illusion<br>Tucson<br>Utah<br>Vintage<br>Wild Laredo<br>Yukon | 40<br>Elegance<br>Princess<br>Santiago<br>Sensation<br>Sunset<br>Trina<br>Victoria | 50<br>Bull<br>Cassiope<br>Dublin | 60<br>Caress<br>Ultrasued | A      | B<br>COM | C<br>alta |
| 057 CHAIR LEFT ARM                     | 34x40x30/39   | 1390    | 1465                  | 1540   | 1615   | 1690                             | 1765                      | 1085   | 1135     | 1185      |
| 061 LOVESEAT RIGHT ARM                 | 57x40x30/39   | 2155    | 2250                  | 2345   | 2440   | 2535                             | 2630                      | 1670   | 1745     | 1820      |
| 071 ARMLESS RECLINING CHAIR            | 23,5x40x30/39 | 1380    | 1445                  | 1510   | 1575   | 1640                             | 1705                      | 1170   | 1235     | 1300      |
| 086 ARMLESS LOVESEAT BUMPER LEFT       | 68x40x30/39   | 2100    | 2210                  | 2320   | 2430   | 2540                             | 2650                      | 1630   | 1710     | 1790      |
| 088 ARMLESS CHAIR BUMPER LEFT          | 45x40x30/39   | 1340    | 1425                  | 1510   | 1595   | 1680                             | 1765                      | 1040   | 1085     | 1130      |
| 089 ARMLESS CHAIR BUMPER RIGHT         | 45x40x30/39   | 1340    | 1425                  | 1510   | 1595   | 1680                             | 1765                      | 1040   | 1085     | 1130      |
| 095 APARTMENT SOFA                     | 81x40x30/39   | 2795    | 2930                  | 3065   | 3200   | 3335                             | 3470                      | 2185   | 2275     | 2365      |
| 096 APARTMENT SOFA LEFT ARM            | 71x40x30/39   | 2405    | 2510                  | 2615   | 2720   | 2825                             | 2930                      | 1860   | 1950     | 2040      |
| 097 APARTMENT SOFA RIGHT ARM           | 71x40x30/39   | 2405    | 2510                  | 2615   | 2720   | 2825                             | 2930                      | 1860   | 1950     | 2040      |
| 124 STORAGE OTTOMAN                    | 30x22x17      | 705     | 730                   | 755  | 780  | 805                              | 830                       | 605    | 615      | 625       |
| 154 UPHOLSTERED ANGULAR TABLE          | 7/34x32.5x19  | 600     | 625                   | 650  | 675  | 700                              | 725                       | 515    | 530      | 545       |
| 163 DBL SWIVEL ROCKING RECLINER CHAIR  | 33 x 34 x 42  | 2200    | 2315                  | 2430   | 2545   | 2660                             | 2775                      | 1795   | 1840     | 1885      |
| 165 DOUBLE RECLINING CHAIR             | 51x40x30/39   | 2235    | 2335                  | 2435   | 2535   | 2635                             | 2735                      | 1850   | 1915     | 1980      |
| 167 APARTMENT SOFA NO ARM BUMPER LEFT  | 82x40x30/39   | 2350    | 2480                  | 2610   | 2740   | 2870                             | 3000                      | 1820   | 1905     | 1990      |
| 168 APARTMENT SOFA NO ARM BUMPER RIGHT | 82x40x30/39   | 2350    | 2480                  | 2610   | 2740   | 2870                             | 3000                      | 1820   | 1905     | 1990      |
| 169 DOUBLE RECLINING CHAIR LEFT ARM    | 41x40x30/39   | 1835    | 1930                  | 2025   | 2120   | 2215                             | 2310                      | 1530   | 1585     | 1640      |
| 170 DOUBLE RECLINING CHAIR RIGHT ARM   | 41x40x30/39   | 1835    | 1930                  | 2025   | 2120   | 2215                             | 2310                      | 1530   | 1585     | 1640      |
| 171 ARMLESS DOUBLE RECLINING CHAIR     | 30,5x40x30/39 | 1500    | 1555                  | 1610   | 1665   | 1720                             | 1775                      | 1240   | 1305     | 1370      |
| 173 DOUBLE LOUNGE CHAIR LEFT ARM       | 41x62x30/39   | 1755    | 1840                  | 1925   | 2010   | 2095                             | 2180                      | 1360   | 1440     | 1520      |
| 174 DOUBLE LOUNGE CHAIR RIGHT ARM      | 41x62x30/39   | 1755    | 1840                  | 1925   | 2010   | 2095                             | 2180                      | 1360   | 1440     | 1520      |
| 175 DOUBLE CHAIR LEFT ARM              | 41x40x30/39   | 1485    | 1570                  | 1655   | 1740   | 1825                             | 1910                      | 1150   | 1220     | 1290      |



## JAMES

Features: Manual adjustable headrest included with all items (2 on square corner). Stitching: Small thread in fabric & large flat thread in leather. Memory foam in seat cushions.

NOTE: 2 recliner seats SEPARATED by a SQUARE CORNER or TABLE cannot be opened at the same time.

OPTIONS - Provide SKETCH of your config:

Small 6" Arm at same price.

Leg on LARGE arm: LG189 metal (Black or Chrome) or LG103 wood. SMALL arm: L64 metal or LG08 wood (specify colour).

Table (154): Specify colour of wood table top.

043 & 163 Chairs: with wood base (specify colour).

Accessories: Anchorage \$35 ea. | Plastic Swivel tray & Wine Glass holder \$35 ea. | Wood Swivel tray \$60 ea. | Tablet holder \$40 ea. & LED Lamp \$35 ea.

\*\*MANUAL RECLINER N/A.\*\* Motorized mechanism included in price of recliner chair items. For Battery Pack add \$160/mechanism.

| Description                           | L x D x H     | Leather |                       |  |  |                                  |                           | Fabric |          |           |
|---------------------------------------|---------------|---------|-----------------------|--|--|----------------------------------|---------------------------|--------|----------|-----------|
|                                       |               | 10      | 20<br>Madras<br>Softy | 30<br>Hugo<br>Fantasy<br>Illusion<br>Tucson<br>Utah<br>Vintage<br>Wild Laredo<br>Yukon | 40<br>Elegance<br>Princess<br>Santiago<br>Sensation<br>Sunset<br>Trina<br>Victoria | 50<br>Bull<br>Cassiope<br>Dublin | 60<br>Caress<br>Ultrasued | A      | B<br>COM | C<br>alta |
| 176 DOUBLE CHAIR RIGHT ARM            | 41x40x30/39   | 1485    | 1570                  | 1655   | 1740   | 1825                             | 1910                      | 1150   | 1220     | 1290      |
| 177 ARMLESS DOUBLE CHAIR              | 30,5x40x30/39 | 1130    | 1200                  | 1270   | 1340   | 1410                             | 1480                      | 880    | 940      | 1000      |
| 178 ARMLESS DOUBLE CHAIR BUMPER LEFT  | 52x40x30/39   | 1455    | 1540                  | 1625   | 1710   | 1795                             | 1880                      | 1130   | 1180     | 1230      |
| 179 ARMLESS DOUBLE CHAIR BUMPER RIGHT | 52x40x30/39   | 1455    | 1540                  | 1625   | 1710   | 1795                             | 1880                      | 1130   | 1180     | 1230      |
| <b>CONFIGURATIONS</b>                 |               |         |                       |  |  |                                  |                           |        |          |           |
| A CONFIG (169-170)                    | 82X40X30/39   | 3670    | 3860                  | 4050   | 4240   | 4430                             | 4620                      | 3060   | 3170     | 3280      |
| B CONFIG (169-171-174)                | 113X62X30/39  | 5090    | 5325                  | 5560   | 5795   | 6030                             | 6265                      | 4130   | 4330     | 4530      |
| C CONFIG (096-055-171-170)            | 115X116X30/39 | 7605    | 7960                  | 8315   | 8670   | 9025                             | 9380                      | 6090   | 6355     | 6620      |
| D CONFIG (169-171-055-179)            | 116X96X30/39  | 6655    | 6990                  | 7325   | 7660   | 7995                             | 8330                      | 5360   | 5585     | 5810      |
| J CONFIG (041-042)                    | 68X40X30/39   | 3490    | 3630                  | 3770   | 3910   | 4050                             | 4190                      | 2950   | 3020     | 3090      |
| K CONFIG (041-071-005)                | 92X62X30/39   | 4725    | 4940                  | 5155   | 5370   | 5585                             | 5800                      | 3895   | 4060     | 4225      |
| L CONFIG (012-055-071-042)            | 101X102X30/39 | 7145    | 7475                  | 7805   | 8135   | 8465                             | 8795                      | 5775   | 6005     | 6235      |
| M CONFIG (041-071-055-089)            | 102X89X30/39  | 6330    | 6650                  | 6970   | 7290   | 7610                             | 7930                      | 5145   | 5345     | 5545      |





# JAMES

**LINEA 30** Collection



Conçu et fabriqué fièrement au Canada  
Proudly designed and made in Canada

Nos produits sont fabriqués à la main et des variations mineures peuvent survenir

Our product is hand-made and minor variations can occur.

## SPECIFICATIONS

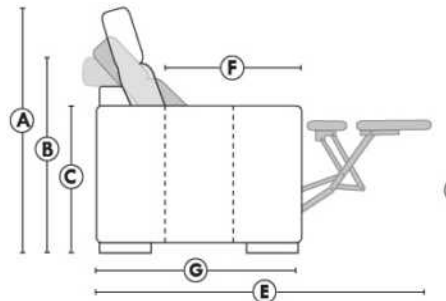

- Appui-tête levé Headrest up
- Appui-tête baissé Headrest down
- Complètement incliné Fully reclined

- A** Hauteur complète 39" Total Height
- B** Hauteur appui-tête baissé 30" Height headrest down
- C** Hauteur du bras 24" Arm Height
- D** Hauteur du siège 19,5" Seat height
- E** Profondeur inclinée 63" Depth fully reclined
- F** Profondeur d'assise 20" Seat depth
- G** Profondeur appui-tête monté 37,5" Depth with headrest up

## BRAS | ARMS

Option de bras:  
Bras Régulier Large 10" ou Petit bras 6"

Arm option  
Regular arm Large 10" or Small arm 6"

Contrôle de l'inclinaison situé à l'intérieur du bras  
Recliner control located on the inside of the arm.

Option d'accessoires disponible sur le bras régulier seulement  
Accessories option, available on Regular arms ONLY.

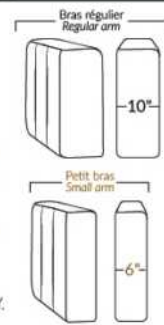

## FAUTEUIL BERÇANT PIVOTANT INCLINABLE SWIVEL ROCKING MOTION CHAIR

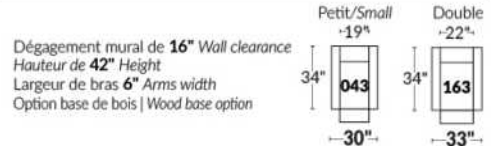

## SIÈGE 23" DE LARGE | 23" SEAT WIDTH

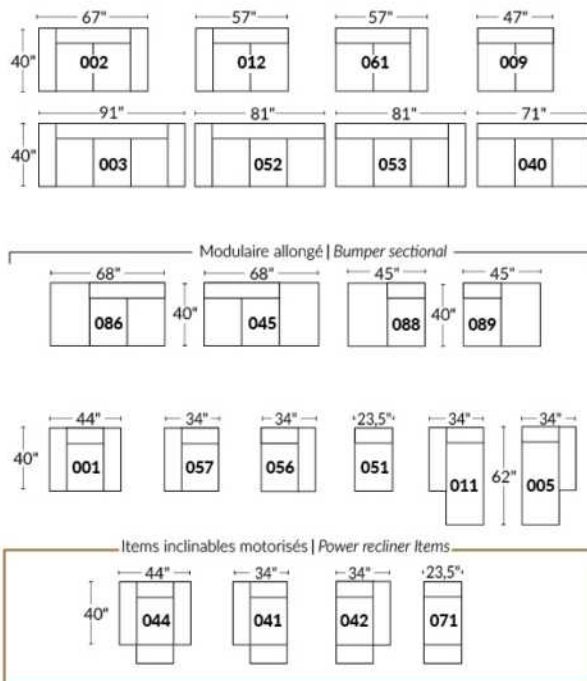

## SIÈGE 30" DE LARGE | 30" SEAT WIDTH

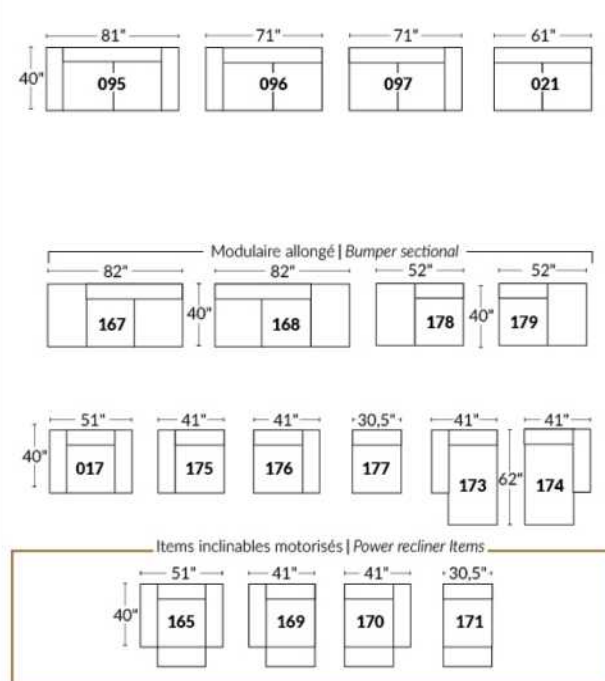

### Autres | Others

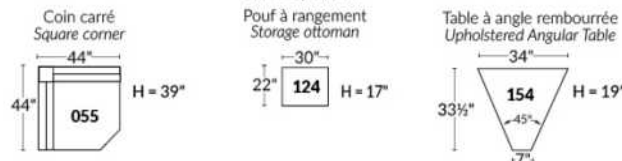

## EXEMPLE 23" EXAMPLE

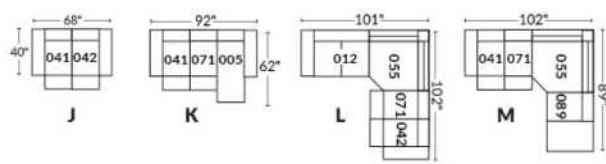

## EXEMPLE 30" EXAMPLE

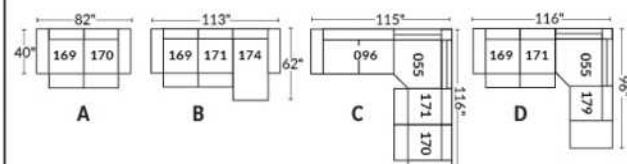



## JESSE

Features: Manual adjustable headrest included (2 on square corner). Stitching: Small thread in fabric and large flat thread in leather. Memory foam in seat cushions. Chairs 043 & 163: Have NO METAL BAR on arm.

NOTE: 2 recliner seats SEPARATED by a square corner or table cannot be opened at the same time.

OPTIONS - Provide SKETCH of your config.:

Leg: LG189 metal (Black or Chrome) or LG103 wood (specify colour).

Table (154): Specify colour of wood table top.

043 & 163 Chairs: with wood base (specify colour).

Accessories: Anchorage \$35 ea. | Plastic Swivel tray & Wine Glass holder \$35 ea. | Wood Swivel tray \$60 ea. | Tablet holder \$40 ea. & LED Lamp \$35 ea.

\*\*MANUAL RECLINER N/A.\*\* Motorized mechanism included in price of recliner chair items. For Battery Pack add \$160/mechanism.

| Description                        | L x D x H     | Leather |                       |  |  |                                  |                           | Fabric |          |           |
|------------------------------------|---------------|---------|-----------------------|--|--|----------------------------------|---------------------------|--------|----------|-----------|
|                                    |               | 10      | 20<br>Madras<br>Softy | 30<br>Hugo<br>Fantasy<br>Illusion<br>Tucson<br>Utah<br>Vintage<br>Wild Laredo<br>Yukon | 40<br>Elegance<br>Princess<br>Santiago<br>Sensation<br>Sunset<br>Trina<br>Victoria | 50<br>Bull<br>Cassiope<br>Dublin | 60<br>Caress<br>Ultrasued | A      | B<br>COM | C<br>alta |
| 001 CHAIR                          | 44X40X30/39   | 1805    | 1910                  | 2015   | 2120   | 2225                             | 2330                      | 1445   | 1495     | 1545      |
| 002 LOVESEAT                       | 67X40X30/39   | 2590    | 2690                  | 2790   | 2890   | 2990                             | 3090                      | 2045   | 2110     | 2175      |
| 003 SOFA                           | 91X40X30/39   | 3095    | 3240                  | 3385   | 3530   | 3675                             | 3820                      | 2450   | 2530     | 2610      |
| 005 LOUNGE CHAIR RIGHT ARM         | 34X62X30/39   | 1635    | 1710                  | 1785   | 1860   | 1935                             | 2010                      | 1295   | 1350     | 1405      |
| 009 ARMLESS LOVESEAT               | 47X40X30/39   | 1800    | 1875                  | 1950   | 2025   | 2100                             | 2175                      | 1390   | 1475     | 1560      |
| 011 LOUNGE CHAIR LEFT ARM          | 34X62X30/39   | 1635    | 1710                  | 1785   | 1860   | 1935                             | 2010                      | 1295   | 1350     | 1405      |
| 012 LOVESEAT LEFT ARM              | 57X40X30/39   | 2185    | 2295                  | 2405   | 2515   | 2625                             | 2735                      | 1725   | 1795     | 1865      |
| 017 DOUBLE CHAIR                   | 51X40X30/39   | 1915    | 2010                  | 2105   | 2200   | 2295                             | 2390                      | 1510   | 1575     | 1640      |
| 021 APARTMENT SOFA NO ARM          | 61X40X30/39   | 2050    | 2145                  | 2240   | 2335   | 2430                             | 2525                      | 1580   | 1660     | 1740      |
| 040 ARMLESS SOFA                   | 71X40X30/39   | 2315    | 2420                  | 2525   | 2630   | 2735                             | 2840                      | 1800   | 1895     | 1990      |
| 041 RECLINING CHAIR LEFT ARM       | 34X40X30/39   | 1780    | 1850                  | 1920   | 1990   | 2060                             | 2130                      | 1495   | 1540     | 1585      |
| 042 RECLINING CHAIR RIGHT ARM      | 34X40X30/39   | 1780    | 1850                  | 1920   | 1990   | 2060                             | 2130                      | 1495   | 1540     | 1585      |
| 043 SWIVEL ROCKING RECLINING CHAIR | 30 x 34 x 42  | 2150    | 2245                  | 2340   | 2435   | 2530                             | 2625                      | 1790   | 1835     | 1880      |
| 044 RECLINER CHAIR                 | 44X40X30/39   | 2165    | 2255                  | 2345   | 2435   | 2525                             | 2615                      | 1810   | 1855     | 1900      |
| 045 ARMLESS LOVESEAT BUMPER RIGHT  | 68X40X30/39   | 2100    | 2210                  | 2320   | 2430   | 2540                             | 2650                      | 1630   | 1710     | 1790      |
| 051 ARMLESS CHAIR                  | 23,5X40X30/39 | 1040    | 1100                  | 1160   | 1220   | 1280                             | 1340                      | 795    | 855      | 915       |
| 052 SOFA LEFT ARM                  | 81X40X30/39   | 2700    | 2835                  | 2970   | 3105   | 3240                             | 3375                      | 2120   | 2210     | 2300      |
| 053 SOFA RIGHT ARM                 | 81X40X30/39   | 2700    | 2835                  | 2970   | 3105   | 3240                             | 3375                      | 2120   | 2210     | 2300      |
| 055 SQUARE CORNER                  | 44X44X30/39   | 1865    | 1965                  | 2065   | 2165   | 2265                             | 2365                      | 1460   | 1515     | 1570      |
| 056 CHAIR RIGHT ARM                | 34X40X30/39   | 1420    | 1495                  | 1570   | 1645   | 1720                             | 1795                      | 1130   | 1165     | 1200      |
| 057 CHAIR LEFT ARM                 | 34X40X30/39   | 1420    | 1495                  | 1570   | 1645   | 1720                             | 1795                      | 1130   | 1165     | 1200      |
| 061 LOVESEAT RIGHT ARM             | 57X40X30/39   | 2185    | 2295                  | 2405   | 2515   | 2625                             | 2735                      | 1725   | 1795     | 1865      |



## JESSE

Features: Manual adjustable headrest included (2 on square corner). Stitching: Small thread in fabric and large flat thread in leather. Memory foam in seat cushions. Chairs 043 & 163: Have NO METAL BAR on arm.

NOTE: 2 recliner seats SEPARATED by a square corner or table cannot be opened at the same time.

OPTIONS - Provide SKETCH of your config.:

Leg: LG189 metal (Black or Chrome) or LG103 wood (specify colour).

Table (154): Specify colour of wood table top.

043 & 163 Chairs: with wood base (specify colour).

Accessories: Anchorage \$35 ea. | Plastic Swivel tray & Wine Glass holder \$35 ea. | Wood Swivel tray \$60 ea. | Tablet holder \$40 ea. & LED Lamp \$35 ea.

\*\*MANUAL RECLINER N/A.\*\* Motorized mechanism included in price of recliner chair items. For Battery Pack add \$160/mechanism.

| Description                            | L x D x H     | Leather |                       |  |  |                                  |                           | Fabric |          |           |
|--|---------------|---------|-----------------------|--|--|----------------------------------|---------------------------|--------|----------|-----------|
|  |               | 10      | 20<br>Madras<br>Softy | 30<br>Hugo<br>Fantasy<br>Illusion<br>Tucson<br>Utah<br>Vintage<br>Wild Laredo<br>Yukon | 40<br>Elegance<br>Princess<br>Santiago<br>Sensation<br>Sunset<br>Trina<br>Victoria | 50<br>Bull<br>Cassiope<br>Dublin | 60<br>Caress<br>Ultrasued | A      | B<br>COM | C<br>alta |
| 071 ARMLESS RECLINING CHAIR            | 23,5X40X30/39 | 1395    | 1455                  | 1515   | 1575   | 1635                             | 1695                      | 1170   | 1235     | 1300      |
| 086 ARMLESS LOVESEAT BUMPER LEFT       | 68X40X30/39   | 2100    | 2210                  | 2320   | 2430   | 2540                             | 2650                      | 1630   | 1710     | 1790      |
| 088 ARMLESS CHAIR BUMPER LEFT          | 45X40X30/39   | 1340    | 1425                  | 1510   | 1595   | 1680                             | 1765                      | 1040   | 1085     | 1130      |
| 089 ARMLESS CHAIR BUMPER RIGHT         | 45X40X30/39   | 1340    | 1425                  | 1510   | 1595   | 1680                             | 1765                      | 1040   | 1085     | 1130      |
| 095 APARTMENT SOFA                     | 81X40X30/39   | 2815    | 2955                  | 3095   | 3235   | 3375                             | 3515                      | 2215   | 2315     | 2415      |
| 096 APARTMENT SOFA LEFT ARM            | 71X40X30/39   | 2440    | 2570                  | 2700   | 2830   | 2960                             | 3090                      | 1895   | 1980     | 2065      |
| 097 APARTMENT SOFA RIGHT ARM           | 71X40X30/39   | 2440    | 2570                  | 2700   | 2830   | 2960                             | 3090                      | 1895   | 1980     | 2065      |
| 124 STORAGE OTTOMAN                    | 30X22X17      | 705     | 730                   | 755  | 780  | 805                              | 830                       | 605    | 615      | 625       |
| 154 UPHOLSTERED ANGULAR TABLE          | 7/34X32.5X19  | 600     | 625                   | 650  | 675  | 700                              | 725                       | 515    | 530      | 545       |
| 163 DBL SWIVEL ROCKING RECLINER CHAIR  | 33 x 34 x 42  | 2200    | 2315                  | 2430   | 2545   | 2660                             | 2775                      | 1795   | 1840     | 1885      |
| 165 DOUBLE RECLINING CHAIR             | 51X40X30/39   | 2270    | 2365                  | 2460   | 2555   | 2650                             | 2745                      | 1890   | 1965     | 2040      |
| 167 APARTMENT SOFA NO ARM BUMPER LEFT  | 82X40X30/39   | 2350    | 2480                  | 2610   | 2740   | 2870                             | 3000                      | 1820   | 1905     | 1990      |
| 168 APARTMENT SOFA NO ARM BUMPER RIGHT | 82X40X30/39   | 2350    | 2480                  | 2610   | 2740   | 2870                             | 3000                      | 1820   | 1905     | 1990      |
| 169 DOUBLE RECLINING CHAIR LEFT ARM    | 41X40X30/39   | 1885    | 1965                  | 2045   | 2125   | 2205                             | 2285                      | 1560   | 1630     | 1700      |
| 170 DOUBLE RECLINING CHAIR RIGHT ARM   | 41X40X30/39   | 1885    | 1965                  | 2045   | 2125   | 2205                             | 2285                      | 1560   | 1630     | 1700      |
| 171 ARMLESS DOUBLE RECLINING CHAIR     | 30,5X40X30/39 | 1500    | 1555                  | 1610   | 1665   | 1720                             | 1775                      | 1240   | 1305     | 1370      |
| 173 DOUBLE LOUNGE CHAIR LEFT ARM       | 41X62X30/39   | 1790    | 1885                  | 1980   | 2075   | 2170                             | 2265                      | 1395   | 1485     | 1575      |
| 174 DOUBLE LOUNGE CHAIR RIGHT ARM      | 41X62X30/39   | 1790    | 1885                  | 1980   | 2075   | 2170                             | 2265                      | 1395   | 1485     | 1575      |
| 175 DOUBLE CHAIR LEFT ARM              | 41X40X30/39   | 1520    | 1600                  | 1680   | 1760   | 1840                             | 1920                      | 1180   | 1270     | 1360      |
| 176 DOUBLE CHAIR RIGHT ARM             | 41X40X30/39   | 1520    | 1600                  | 1680   | 1760   | 1840                             | 1920                      | 1180   | 1270     | 1360      |
| 177 ARMLESS DOUBLE CHAIR               | 30,5X40X30/39 | 1130    | 1200                  | 1270   | 1340   | 1410                             | 1480                      | 880    | 940      | 1000      |
| 178 ARMLESS DOUBLE CHAIR BUMPER LEFT   | 52X40X30/39   | 1455    | 1540                  | 1625   | 1710   | 1795                             | 1880                      | 1130   | 1180     | 1230      |



## JESSE

Features: Manual adjustable headrest included (2 on square corner). Stitching: Small thread in fabric and large flat thread in leather. Memory foam in seat cushions. Chairs 043 & 163: Have NO METAL BAR on arm.

NOTE: 2 recliner seats SEPARATED by a square corner or table cannot be opened at the same time.

OPTIONS - Provide SKETCH of your config.:

Leg: LG189 metal (Black or Chrome) or LG103 wood (specify colour).

Table (154): Specify colour of wood table top.

043 & 163 Chairs: with wood base (specify colour).

Accessories: Anchorage \$35 ea. | Plastic Swivel tray & Wine Glass holder \$35 ea. | Wood Swivel tray \$60 ea. | Tablet holder \$40 ea. & LED Lamp \$35 ea.

\*\*MANUAL RECLINER N/A.\*\* Motorized mechanism included in price of recliner chair items. For Battery Pack add \$160/mechanism.

| Description                           | L x D x H     | Leather |                       |  |  |                                  |                           | Fabric |          |           |
|---------------------------------------|---------------|---------|-----------------------|--|--|----------------------------------|---------------------------|--------|----------|-----------|
|                                       |               | 10      | 20<br>Madras<br>Softy | 30<br>Hugo<br>Fantasy<br>Illusion<br>Tucson<br>Utah<br>Vintage<br>Wild Laredo<br>Yukon | 40<br>Elegance<br>Princess<br>Santiago<br>Sensation<br>Sunset<br>Trina<br>Victoria | 50<br>Bull<br>Cassiope<br>Dublin | 60<br>Caress<br>Ultrasued | A      | B<br>COM | C<br>alta |
| 179 ARMLESS DOUBLE CHAIR BUMPER RIGHT | 52X40X30/39   | 1455    | 1540                  | 1625   | 1710   | 1795                             | 1880                      | 1130   | 1180     | 1230      |
| <b>CONFIGURATIONS</b>                 |               |         |                       |  |  |                                  |                           |        |          |           |
| A CONFIG (169-170)                    | 82X40X30/39   | 3770    | 3930                  | 4090   | 4250   | 4410                             | 4570                      | 3120   | 3260     | 3400      |
| B CONFIG (169-171-174)                | 113X62X30/39  | 5175    | 5405                  | 5635   | 5865   | 6095                             | 6325                      | 4195   | 4420     | 4645      |
| C CONFIG (096-055-171-170)            | 115X116X30/39 | 7690    | 8055                  | 8420   | 8785   | 9150                             | 9515                      | 6155   | 6430     | 6705      |
| D CONFIG (169-171-055-179)            | 116X96X30/39  | 6705    | 7025                  | 7345   | 7665   | 7985                             | 8305                      | 5390   | 5630     | 5870      |
| J CONFIG (041-042)                    | 68X40X30/39   | 3560    | 3700                  | 3840   | 3980   | 4120                             | 4260                      | 2990   | 3080     | 3170      |
| K CONFIG (041-071-005)                | 92X62X30/39   | 4810    | 5015                  | 5220   | 5425   | 5630                             | 5835                      | 3960   | 4125     | 4290      |
| L CONFIG (012-055-071-042)            | 101X102X30/39 | 7225    | 7565                  | 7905   | 8245   | 8585                             | 8925                      | 5850   | 6085     | 6320      |
| M CONFIG (041-071--055-089)           | 102X89X30/39  | 6380    | 6695                  | 7010   | 7325   | 7640                             | 7955                      | 5165   | 5375     | 5585      |



# JESSE

LINEA 30 Collection



Conçu et fabriqué fièrement au Canada  
Proudly designed and made in Canada

Nos produits sont fabriqués à la main et des variations mineures peuvent survenir

Our product is hand-made and minor variations can occur.

## SPECIFICATIONS

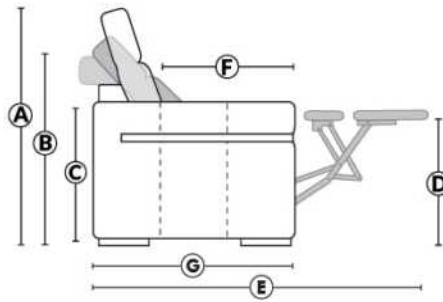

- Appui-tête levé / Headrest up
- Appui-tête baissé / Headrest down
- Complètement incliné / Fully reclined

- (A) Hauteur complète 39" Total Height
- (B) Hauteur appui-tête baissé 30" Height headrest down
- (C) Hauteur du bras 24" Arm Height
- (D) Hauteur du siège 19,5" Seat height
- (E) Profondeur inclinée 63" Depth fully reclined
- (F) Profondeur d'assise 20" Seat depth
- (G) Profondeur appui-tête monté 37,5" Depth with headrest up

## BRAS | ARMS

Contrôle de l'inclinaison situé à l'intérieur du bras  
Recliner control located on the inside of the arm.

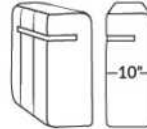

Option d'accessoires disponible  
Accessories option, available

## FAUTEUIL BERÇANT PIVOTANT INCLINABLE SWIVEL ROCKING MOTION CHAIR

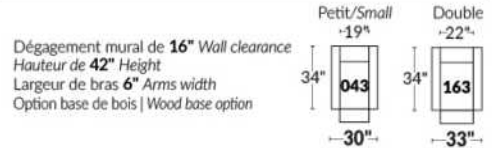

## SIÈGE 23" DE LARGE | 23" SEAT WIDTH

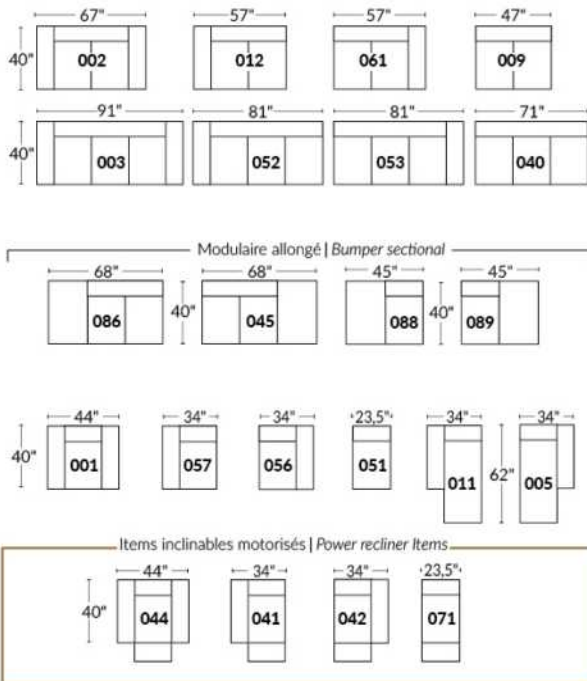

## SIÈGE 30" DE LARGE | 30" SEAT WIDTH

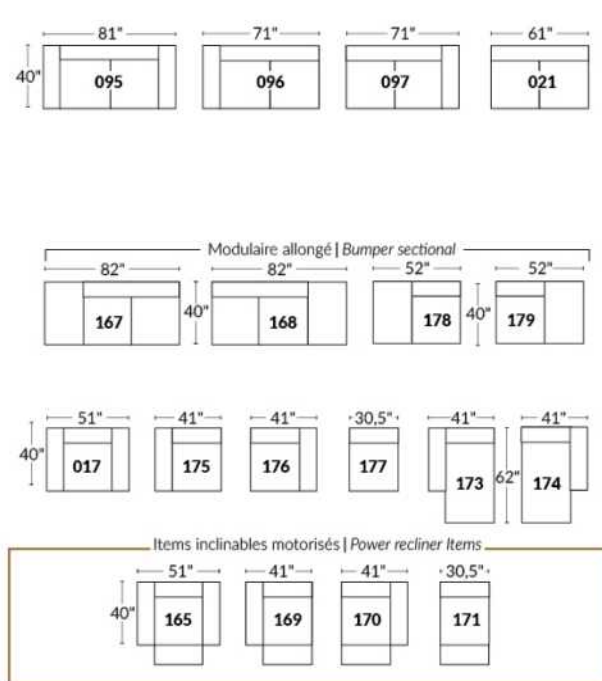

## Autres | Others

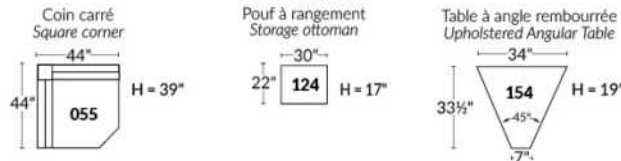

## EXEMPLE 23" EXAMPLE

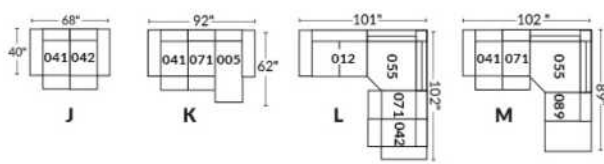

## EXEMPLE 30" EXAMPLE

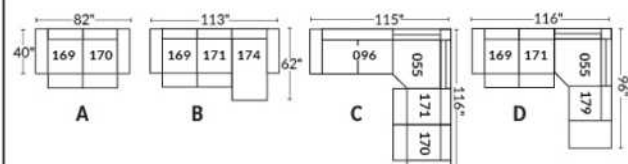

## JULIANNE

Features: Manual adjustable headrest included with all items (2 with square corner). Headrest STATIONARY on Wedge (050). Stitching: Small "French Stitch" in fabric & in leather. Swivel Rocking Recliner Chairs (items 043 & 163 only): seat cushions with 1" memory foam.

Note: 2 recliner seats separated by a wedge (050) or square corner (055) cannot be opened at the same time.

OPTIONS - Provide SKETCH of your config.:

Small 6" Arm: at same price.

Leg (specify colour): on LARGE arm: LG08 wood. On SMALL arm: LG195 wood. Metal legs n/a.

Choice of Seat Depth: 20" or \*22". The \*22" seat depth N/A on chairs #043 & #163.

043 & 163 Chairs: with wood base (specify colour).

Foam (Extra Firm or Memory): Add \$15/seat. Bumper section counts as 1 seat & lounge chairs as 2 seats.

Motorized recliner mechanism with touch-sensor button add \$160/mechanism. | For Battery Pack: add \$320/mechanism.

| Description                        | L x D x H         | Leather |                       |  |  |                                  |                           | Fabric |          |           |
|------------------------------------|-------------------|---------|-----------------------|--|--|----------------------------------|---------------------------|--------|----------|-----------|
|                                    |                   | 10      | 20<br>Madras<br>Softy | 30<br>Hugo<br>Fantasy<br>Illusion<br>Tucson<br>Utah<br>Vintage<br>Wild Laredo<br>Yukon | 40<br>Elegance<br>Princess<br>Santiago<br>Sensation<br>Sunset<br>Trina<br>Victoria | 50<br>Bull<br>Cassiope<br>Dublin | 60<br>Caress<br>Ultrasued | A      | B<br>COM | C<br>alta |
| 001 CHAIR                          | 40 x 40 x 33/40   | 1690    | 1780                  | 1870   | 1960   | 2050                             | 2140                      | 1300   | 1335     | 1370      |
| 002 LOVESEAT                       | 63 x 40 x 33/40   | 2445    | 2580                  | 2715   | 2850   | 2985                             | 3120                      | 1850   | 1935     | 2020      |
| 003 SOFA                           | 87 x 40 x 33/40   | 2940    | 3090                  | 3240   | 3390   | 3540                             | 3690                      | 2220   | 2330     | 2440      |
| 005 LOUNGE CHAIR RIGHT ARM         | 32 x 62 x 33/40   | 1600    | 1680                  | 1760   | 1840   | 1920                             | 2000                      | 1225   | 1295     | 1365      |
| 009 ARMLESS LOVESEAT               | 47 x 40 x 33/40   | 1815    | 1900                  | 1985   | 2070   | 2155                             | 2240                      | 1385   | 1470     | 1555      |
| 011 LOUNGE CHAIR LEFT ARM          | 32 x 62 x 33/40   | 1600    | 1680                  | 1760   | 1840   | 1920                             | 2000                      | 1225   | 1295     | 1365      |
| 012 LOVESEAT LEFT ARM              | 55 x 40 x 33/40   | 2130    | 2225                  | 2320   | 2415   | 2510                             | 2605                      | 1625   | 1695     | 1765      |
| 017 DOUBLE CHAIR                   | 47 x 40 x 33/40   | 1795    | 1905                  | 2015   | 2125   | 2235                             | 2345                      | 1360   | 1425     | 1490      |
| 021 APARTMENT SOFA NO ARM          | 61 x 40 x 33/40   | 2055    | 2150                  | 2245   | 2340   | 2435                             | 2530                      | 1575   | 1655     | 1735      |
| 040 ARMLESS SOFA                   | 71 x 40 x 33/40   | 2320    | 2425                  | 2530   | 2635   | 2740                             | 2845                      | 1785   | 1865     | 1945      |
| 041 RECLINING CHAIR LEFT ARM       | 32 x 40 x 33/40   | 1555    | 1625                  | 1695   | 1765   | 1835                             | 1905                      | 1235   | 1295     | 1355      |
| 042 RECLINING CHAIR RIGHT ARM      | 32 x 40 x 33/40   | 1555    | 1625                  | 1695   | 1765   | 1835                             | 1905                      | 1235   | 1295     | 1355      |
| 043 SWIVEL ROCKING RECLINING CHAIR | 30/33 x 34 x 42   | 1965    | 2060                  | 2155   | 2250   | 2345                             | 2440                      | 1600   | 1645     | 1690      |
| 044 RECLINER CHAIR                 | 40 x 40 x 33/40   | 1855    | 1950                  | 2045   | 2140   | 2235                             | 2330                      | 1485   | 1530     | 1575      |
| 045 ARMLESS LOVESEAT BUMPER RIGHT  | 68 x 40 x 33/40   | 2140    | 2240                  | 2340   | 2440   | 2540                             | 2640                      | 1630   | 1710     | 1790      |
| 050 WEDGE                          | 49 x 49 x 33      | 1600    | 1700                  | 1800   | 1900   | 2000                             | 2100                      | 1150   | 1215     | 1280      |
| 051 ARMLESS CHAIR                  | 23,5 x 40 x 33/40 | 1065    | 1115                  | 1165   | 1215   | 1265                             | 1315                      | 830    | 885      | 940       |
| 052 SOFA LEFT ARM                  | 79 x 40 x 33/40   | 2630    | 2775                  | 2920   | 3065   | 3210                             | 3355                      | 2010   | 2100     | 2190      |
| 053 SOFA RIGHT ARM                 | 79 x 40 x 33/40   | 2630    | 2775                  | 2920   | 3065   | 3210                             | 3355                      | 2010   | 2100     | 2190      |
| 055 SQUARE CORNER                  | 44 x 44 x 33/40   | 1880    | 1975                  | 2070   | 2165   | 2260                             | 2355                      | 1450   | 1510     | 1570      |
| 056 CHAIR RIGHT ARM                | 32 x 40 x 33/40   | 1365    | 1450                  | 1535   | 1620   | 1705                             | 1790                      | 1050   | 1100     | 1150      |
| 057 CHAIR LEFT ARM                 | 32 x 40 x 33/40   | 1365    | 1450                  | 1535   | 1620   | 1705                             | 1790                      | 1050   | 1100     | 1150      |

## JULIANNE

Features: Manual adjustable headrest included with all items (2 with square corner). Headrest STATIONARY on Wedge (050). Stitching: Small "French Stitch" in fabric & in leather. Swivel Rocking Recliner Chairs (items 043 & 163 only): seat cushions with 1" memory foam.

Note: 2 recliner seats separated by a wedge (050) or square corner (055) cannot be opened at the same time.

OPTIONS - Provide SKETCH of your config.:

Small 6" Arm: at same price.

Leg (specify colour): on LARGE arm: LG08 wood. On SMALL arm: LG195 wood. Metal legs n/a.

Choice of Seat Depth: 20" or \*22". The \*22" seat depth N/A on chairs #043 & #163.

043 & 163 Chairs: with wood base (specify colour).

Foam (Extra Firm or Memory): Add \$15/seat. Bumper section counts as 1 seat & lounge chairs as 2 seats.

Motorized recliner mechanism with touch-sensor button add \$160/mechanism. | For Battery Pack: add \$320/mechanism.

| Description                            | L x D x H         | Leather |                       |  |  |                                  |                           | Fabric |          |           |
|--|-------------------|---------|-----------------------|--|--|----------------------------------|---------------------------|--------|----------|-----------|
|  |                   | 10      | 20<br>Madras<br>Softy | 30<br>Hugo<br>Fantasy<br>Illusion<br>Tucson<br>Utah<br>Vintage<br>Wild Laredo<br>Yukon | 40<br>Elegance<br>Princess<br>Santiago<br>Sensation<br>Sunset<br>Trina<br>Victoria | 50<br>Bull<br>Cassiope<br>Dublin | 60<br>Caress<br>Ultrasued | A      | B<br>COM | C<br>alta |
| 061 LOVESEAT RIGHT ARM                 | 55 x 40 x 33/40   | 2130    | 2225                  | 2320   | 2415   | 2510                             | 2605                      | 1625   | 1695     | 1765      |
| 071 ARMLESS RECLINING CHAIR            | 23,5 x 40 x 33/40 | 1260    | 1295                  | 1330   | 1365   | 1400                             | 1435                      | 1005   | 1070     | 1135      |
| 086 ARMLESS LOVESEAT BUMPER LEFT       | 68 x 40 x 33/40   | 2140    | 2240                  | 2340   | 2440   | 2540                             | 2640                      | 1630   | 1710     | 1790      |
| 088 ARMLESS CHAIR BUMPER LEFT          | 45 x 40 x 33/40   | 1370    | 1460                  | 1550   | 1640   | 1730                             | 1820                      | 1055   | 1115     | 1175      |
| 089 ARMLESS CHAIR BUMPER RIGHT         | 45 x 40 x 33/40   | 1370    | 1460                  | 1550   | 1640   | 1730                             | 1820                      | 1055   | 1115     | 1175      |
| 095 APARTMENT SOFA                     | 77 x 40 x 33/40   | 2680    | 2820                  | 2960   | 3100   | 3240                             | 3380                      | 2045   | 2120     | 2195      |
| 096 APARTMENT SOFA LEFT ARM            | 69 x 40 x 33/40   | 2355    | 2475                  | 2595   | 2715   | 2835                             | 2955                      | 1805   | 1895     | 1985      |
| 097 APARTMENT SOFA RIGHT ARM           | 69 x 40 x 33/40   | 2355    | 2475                  | 2595   | 2715   | 2835                             | 2955                      | 1805   | 1895     | 1985      |
| 124 STORAGE OTTOMAN                    | 30 x 22 x 17      | 705     | 730                   | 755  | 780  | 805                              | 830                       | 605    | 615      | 625       |
| 163 DBL SWIVEL ROCKING RECLINER CHAIR  | 33/36 X 34 X 42   | 2010    | 2125                  | 2240   | 2355   | 2470                             | 2585                      | 1605   | 1650     | 1695      |
| 165 DOUBLE RECLINING CHAIR             | 47 x 40 x 33/40   | 1980    | 2075                  | 2170   | 2265   | 2360                             | 2455                      | 1545   | 1615     | 1685      |
| 167 APARTMENT SOFA NO ARM BUMPER LEFT  | 82 x 40 x 33/40   | 2360    | 2490                  | 2620   | 2750   | 2880                             | 3010                      | 1820   | 1905     | 1990      |
| 168 APARTMENT SOFA NO ARM BUMPER RIGHT | 82 x 40 x 33/40   | 2360    | 2490                  | 2620   | 2750   | 2880                             | 3010                      | 1820   | 1905     | 1990      |
| 169 DOUBLE RECLINING CHAIR LEFT ARM    | 39 x 40 x 33/40   | 1650    | 1745                  | 1840   | 1935   | 2030                             | 2125                      | 1325   | 1380     | 1435      |
| 170 DOUBLE RECLINING CHAIR RIGHT ARM   | 39 x 40 x 33/40   | 1650    | 1745                  | 1840   | 1935   | 2030                             | 2125                      | 1325   | 1380     | 1435      |
| 171 ARMLESS DOUBLE RECLINING CHAIR     | 30,5 x 40 x 33/40 | 1345    | 1410                  | 1475   | 1540   | 1605                             | 1670                      | 1085   | 1145     | 1205      |
| 173 DOUBLE LOUNGE CHAIR LEFT ARM       | 39 x 62 x 33/40   | 1755    | 1840                  | 1925   | 2010   | 2095                             | 2180                      | 1335   | 1430     | 1525      |
| 174 DOUBLE LOUNGE CHAIR RIGHT ARM      | 39 x 62 x 33/40   | 1755    | 1840                  | 1925   | 2010   | 2095                             | 2180                      | 1335   | 1430     | 1525      |
| 175 DOUBLE CHAIR LEFT ARM              | 39 x 40 x 33/40   | 1485    | 1570                  | 1655   | 1740   | 1825                             | 1910                      | 1140   | 1205     | 1270      |
| 176 DOUBLE CHAIR RIGHT ARM             | 39 x 40 x 33/40   | 1485    | 1570                  | 1655   | 1740   | 1825                             | 1910                      | 1140   | 1205     | 1270      |
| 177 ARMLESS DOUBLE CHAIR               | 30,5 x 40 x 33/40 | 1160    | 1230                  | 1300   | 1370   | 1440                             | 1510                      | 900    | 965      | 1030      |
| 178 ARMLESS DOUBLE CHAIR BUMPER LEFT   | 52 x 40 x 33/40   | 1495    | 1585                  | 1675   | 1765   | 1855                             | 1945                      | 1145   | 1215     | 1285      |

## JULIANNE

Features: Manual adjustable headrest included with all items (2 with square corner). Headrest STATIONARY on Wedge (050). Stitching: Small "French Stitch" in fabric & in leather. Swivel Rocking Recliner Chairs (items 043 & 163 only): seat cushions with 1" memory foam.

Note: 2 recliner seats separated by a wedge (050) or square corner (055) cannot be opened at the same time.

OPTIONS - Provide SKETCH of your config.:

Small 6" Arm: at same price.

Leg (specify colour): on LARGE arm: LG08 wood. On SMALL arm: LG195 wood. Metal legs n/a.

Choice of Seat Depth: 20" or \*22". The \*22" seat depth N/A on chairs #043 & #163.

043 & 163 Chairs: with wood base (specify colour).

Foam (Extra Firm or Memory): Add \$15/seat. Bumper section counts as 1 seat & lounge chairs as 2 seats.

Motorized recliner mechanism with touch-sensor button add \$160/mechanism. | For Battery Pack: add \$320/mechanism.

| Description                           | L x D x H       | Leather |                       |  |  |                                  |                           | Fabric |          |           |
|---------------------------------------|-----------------|---------|-----------------------|--|--|----------------------------------|---------------------------|--------|----------|-----------|
|                                       |                 | 10      | 20<br>Madras<br>Softy | 30<br>Hugo<br>Fantasy<br>Illusion<br>Tucson<br>Utah<br>Vintage<br>Wild Laredo<br>Yukon | 40<br>Elegance<br>Princess<br>Santiago<br>Sensation<br>Sunset<br>Trina<br>Victoria | 50<br>Bull<br>Cassiope<br>Dublin | 60<br>Caress<br>Ultrasued | A      | B<br>COM | C<br>alta |
| 179 ARMLESS DOUBLE CHAIR BUMPER RIGHT | 52 x 40 x 33/40 | 1495    | 1585                  | 1675   | 1765   | 1855                             | 1945                      | 1145   | 1215     | 1285      |
| <b>CONFIGURATIONS</b>                 |                 |         |                       |  |  |                                  |                           |        |          |           |
| A CONFIG (169-170)                    | 78X40X33/40     | 3300    | 3490                  | 3680   | 3870   | 4060                             | 4250                      | 2650   | 2760     | 2870      |
| B CONFIG (169-171-174)                | 109X62X33/40    | 4750    | 4995                  | 5240   | 5485   | 5730                             | 5975                      | 3745   | 3955     | 4165      |
| C CONFIG (096-055-171-170)            | 113X114X33/40   | 7230    | 7605                  | 7980   | 8355   | 8730                             | 9105                      | 5665   | 5930     | 6195      |
| D CONFIG (169-171-055-179)            | 114X96X33/40    | 6370    | 6715                  | 7060   | 7405   | 7750                             | 8095                      | 5005   | 5250     | 5495      |
| J CONFIG (041-042)                    | 64X40X33/40     | 3110    | 3250                  | 3390   | 3530   | 3670                             | 3810                      | 2470   | 2590     | 2710      |
| K CONFIG (041-071-005)                | 88X62X33/40     | 4415    | 4600                  | 4785   | 4970   | 5155                             | 5340                      | 3465   | 3660     | 3855      |
| L CONFIG (012-055-071-042)            | 99X100X33/40    | 6825    | 7120                  | 7415   | 7710   | 8005                             | 8300                      | 5315   | 5570     | 5825      |
| M CONFIG (041-071-055-089)            | 100X 89X33/40   | 6065    | 6355                  | 6645   | 6935   | 7225                             | 7515                      | 4745   | 4990     | 5235      |





# JULIANNE

PARALLELE  
Collection 33

Jaymar

Conçu et fabriqué fièrement au Canada  
Proudly designed and made in Canada

Nos produits sont fabriqués à la main et des variations mineures peuvent survenir

Our product is hand-made and minor variations can occur.

## SPECIFICATIONS

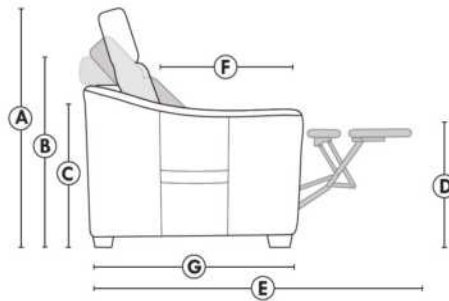

- Appui-tête levé Headrest up
- Appui-tête baissé Headrest down
- Complètement incliné Fully reclined

- A** Hauteur complète 40" Total Height
- B** Hauteur appui-tête baissé 33" Height headrest down
- C** Hauteur du bras 23" Arm Height
- D** Hauteur du siège 19,5" Seat height
- E** Profondeur inclinée 65" Depth fully reclined
- F** Profondeur d'assise 20" ou/ou 22" Seat depth
- G** Profondeur appui-tête monté 37,5" Depth with headrest up

## BRAS | ARMS

Option de bras:  
Bras Régulier Large 8" ou Petit bras 6"

Arm option  
Regular arm Large 8" or Small arm 6"

Contrôle de l'inclinaison situé à l'intérieur du bras  
Recliner control located on the inside of the arm.

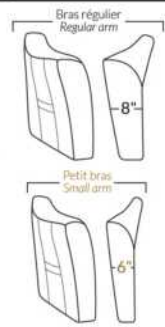

## FAUTEUIL BERÇANT PIVOTANT INCLINABLE SWIVEL ROCKING MOTION CHAIR

Dégagement mural de 16" Wall clearance  
Hauteur de 42" Height  
Largeur de bras 6" Arms width  
Option base de bois | Wood base option



## SIÈGE 23" DE LARGE | 23" SEAT WIDTH

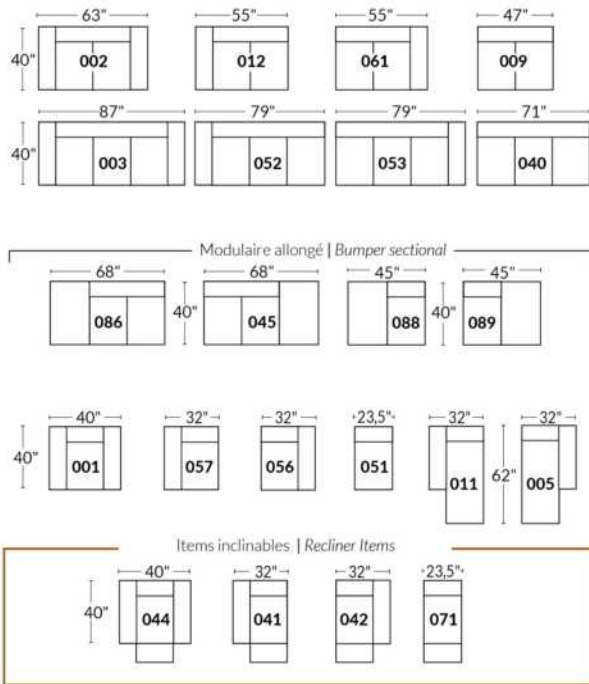

## SIÈGE 30" DE LARGE | 30" SEAT WIDTH

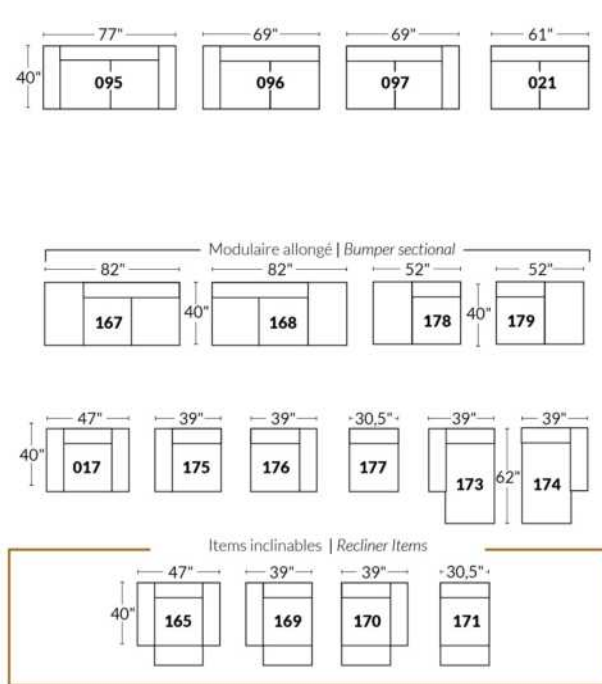

## Autres | Others

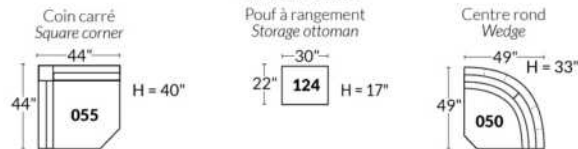

## EXEMPLE 23" EXAMPLE

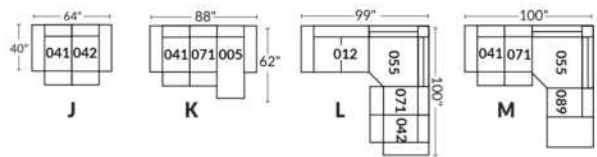

## EXEMPLE 30" EXAMPLE

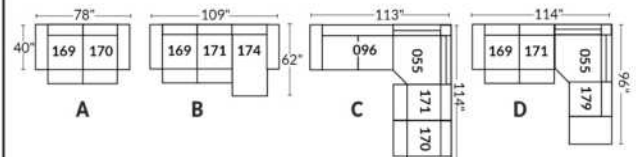

## L'OFFICIEL

### FEATURES:

- The fashion collection offers unparalleled comfort. Each module is filled with a 100% Canadian feather mix.
- The envelopes are compartmentalized in 100% cotton casings to equally maintain the feathers in the cushions while minimizing feather leaks.
- All furniture pieces are finished on the sides and can be arranged as a sectional or as standalone pieces.
- Each item has a discreet fastening system that can be turned under the furniture.

Items #256 Large Square Ottoman & #257 Upholstered Square Table can be use as a square corner.

### BACK CUSHIONS

The back cushions (large & small) are included in the identified items. (See sketch).

You must choose the style of back cushions either: FASHION I (full width) or FASHION II (square cushion).

Note: You may not combine a Fashion I and II style cushion within the same item.

Ex: You can take a Fashion I cushion for a chair 001 & a Fashion II cushion for a square corner 055.

### Specify on your ORDER:

For each item, specify style (I or II) for the cushions.

You must also specify the cover of the base as well as the cushions.

Ex.: Item 095 base: Cover #1. Cushions Fashion II 833: cover #2 & 834: #3.

Leg: LG203 metal (chrome or black) specify colour.

Upholstered tables items 077, 257 & 258: Specify color of wood table top.

EXTRA Back Cushions: Specify code, cover, color and quantity.

| Description                           | L x D x H   | Leather |                       |  |  |                                  |                           | Fabric |          |           |
|---------------------------------------|-------------|---------|-----------------------|--|--|----------------------------------|---------------------------|--------|----------|-----------|
|                                       |             | 10      | 20<br>Madras<br>Softy | 30<br>Hugo<br>Fantasy<br>Illusion<br>Tucson<br>Utah<br>Vintage<br>Wild Laredo<br>Yukon | 40<br>Elegance<br>Princess<br>Santiago<br>Sensation<br>Sunset<br>Trina<br>Victoria | 50<br>Bull<br>Cassiope<br>Dublin | 60<br>Caress<br>Ultrasued | A      | B<br>COM | C<br>alta |
| 006 OTTOMAN                           | 36x30x18    |         |                       |  |  |                                  |                           | 650    | 670      | 690       |
| 017 DOUBLE CHAIR                      | 57x44x30/35 |         |                       |  |  |                                  |                           | 1340   | 1390     | 1440      |
| 021 APARTMENT SOFA NO ARM             | 71x44x30/35 |         |                       |  |  |                                  |                           | 1750   | 1825     | 1900      |
| 055 SQUARE CORNER                     | 52x52x30/35 |         |                       |  |  |                                  |                           | 1545   | 1595     | 1645      |
| 077 UPHOLSTERED TABLE                 | 36x44x16    |         |                       |  |  |                                  |                           | 900    | 925      | 950       |
| 095 APARTMENT SOFA                    | 93x44x30/35 |         |                       |  |  |                                  |                           | 1970   | 2050     | 2130      |
| 096 APARTMENT SOFA LEFT ARM           | 82x44x30/35 |         |                       |  |  |                                  |                           | 1855   | 1945     | 2035      |
| 097 APARTMENT SOFA RIGHT ARM          | 82x44x30/35 |         |                       |  |  |                                  |                           | 1855   | 1945     | 2035      |
| 115 LARGE OTTOMAN                     | 36x44x18    |         |                       |  |  |                                  |                           | 785    | 820      | 855       |
| 173 DOUBLE LOUNGE CHAIR LEFT ARM      | 41x78x30/35 |         |                       |  |  |                                  |                           | 1655   | 1710     | 1765      |
| 174 DOUBLE LOUNGE CHAIR RIGHT ARM     | 41x78x30/35 |         |                       |  |  |                                  |                           | 1655   | 1710     | 1765      |
| 175 DOUBLE CHAIR LEFT ARM             | 46x44x30/35 |         |                       |  |  |                                  |                           | 1235   | 1285     | 1335      |
| 176 DOUBLE CHAIR RIGHT ARM            | 46x44x30/35 |         |                       |  |  |                                  |                           | 1235   | 1285     | 1335      |
| 177 ARMLESS DOUBLE CHAIR              | 36x44x30/35 |         |                       |  |  |                                  |                           | 1135   | 1165     | 1195      |
| 178 ARMLESS DOUBLE CHAIR BUMPER LEFT  | 60x44x30/35 |         |                       |  |  |                                  |                           | 1480   | 1525     | 1570      |
| 179 ARMLESS DOUBLE CHAIR BUMPER RIGHT | 60x44x30/35 |         |                       |  |  |                                  |                           | 1480   | 1525     | 1570      |

## L'OFFICIEL

### FEATURES:

- The fashion collection offers unparalleled comfort. Each module is filled with a 100% Canadian feather mix.
- The envelopes are compartmentalized in 100% cotton casings to equally maintain the feathers in the cushions while minimizing feather leaks.
- All furniture pieces are finished on the sides and can be arranged as a sectional or as standalone pieces.
- Each item has a discreet fastening system that can be turned under the furniture.

Items #256 Large Square Ottoman & #257 Upholstered Square Table can be use as a square corner.

### BACK CUSHIONS

The back cushions (large & small) are included in the identified items. (See sketch).

You must choose the style of back cushions either: FASHION I (full width) or FASHION II (square cushion).

Note: You may not combine a Fashion I and II style cushion within the same item.

Ex: You can take a Fashion I cushion for a chair 001 & a Fashion II cushion for a square corner 055.

### Specify on your ORDER:

For each item, specify style (I or II) for the cushions.

You must also specify the cover of the base as well as the cushions.

Ex.: Item 095 base: Cover #1. Cushions Fashion II 833: cover #2 & 834: #3.

Leg: LG203 metal (chrome or black) specify colour.

Upholstered tables items 077, 257 & 258: Specify color of wood table top.

EXTRA Back Cushions: Specify code, cover, color and quantity.

| Description                        | L x D x H     | Leather |                       |  |  |                                  |                           | Fabric |          |           |
|------------------------------------|---------------|---------|-----------------------|--|--|----------------------------------|---------------------------|--------|----------|-----------|
|                                    |               | 10      | 20<br>Madras<br>Softy | 30<br>Hugo<br>Fantasy<br>Illusion<br>Tucson<br>Utah<br>Vintage<br>Wild Laredo<br>Yukon | 40<br>Elegance<br>Princess<br>Santiago<br>Sensation<br>Sunset<br>Trina<br>Victoria | 50<br>Bull<br>Cassiope<br>Dublin | 60<br>Caress<br>Ultrasued | A      | B<br>COM | C<br>alta |
| 256 LARGE SQUARE OTTOMAN           | 44x44x18      |         |                       |  |  |                                  |                           | 955    | 985      | 1015      |
| 257 UPHOLSTERED SQUARE TABLE       | 44x44x16      |         |                       |  |  |                                  |                           | 1155   | 1185     | 1215      |
| 258 SMALL UPHOLSTERED TABLE        | 15x44x16      |         |                       |  |  |                                  |                           | 600    | 615      | 630       |
| 831 F I: LARGE BACK CUSHION 34X19  | 34x7x19       |         |                       |  |  |                                  |                           | 105    | 105      | 105       |
| 832 F 1: SMALL BACK CUSHION 24X10  | 24x6x10       |         |                       |  |  |                                  |                           | 85     | 85       | 85        |
| 833 F II: LARGE BACK CUSHION 26X19 | 26x7x19       |         |                       |  |  |                                  |                           | 105    | 105      | 105       |
| 834 F II: SMALL BACK CUSHION 16X16 | 16x6x16       |         |                       |  |  |                                  |                           | 85     | 85       | 85        |
| <b>CONFIGURATIONS</b>              |               |         |                       |  |  |                                  |                           |        |          |           |
| A CONFIG (173-097) + (006)         | 123X78X30/35  |         |                       |  |  |                                  |                           | 4160   | 4325     | 4490      |
| B CONFIG (096-055-176) + (077)     | 98X134X30/35  |         |                       |  |  |                                  |                           | 5535   | 5750     | 5965      |
| C CONFIG (175-115-055-097)         | 134X134X30/35 |         |                       |  |  |                                  |                           | 5420   | 5645     | 5870      |
| D CONFIG (173-177-055-097)         | 129X134X30/35 |         |                       |  |  |                                  |                           | 6190   | 6415     | 6640      |

## FASHION COLLECTION

### FASHION I

COUSSINS PLEINE LARGEUR  
 FULL BACK CUSHIONS

831 34 x 7 x 19  
 832 24 x 6 x 10



### FASHION II

COUSSINS CARRÉS - DOS APPARENT  
 SQUARE CUSHIONS - VISIBLE BACK

833 26 x 7 x 19  
 834 16 x 6 x 16

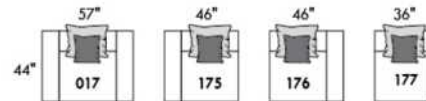
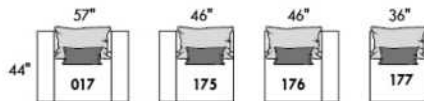
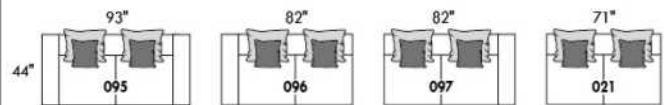
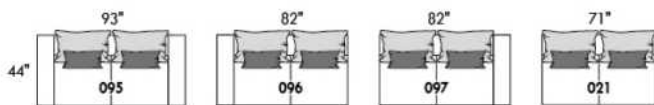

Mélanger & agencer!  
 Mix & Match!

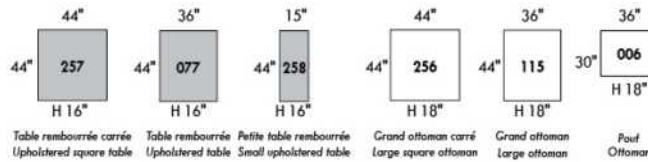
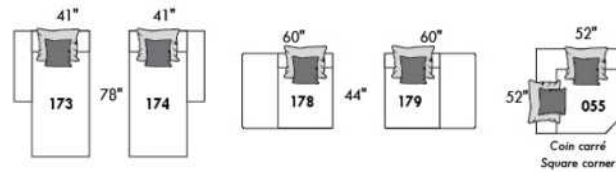
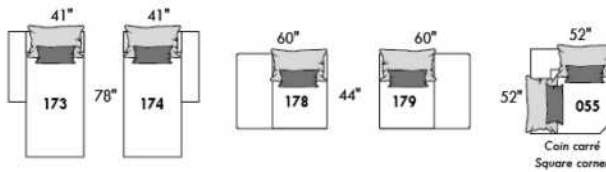

### Populaires | Popular CONFIGURATIONS

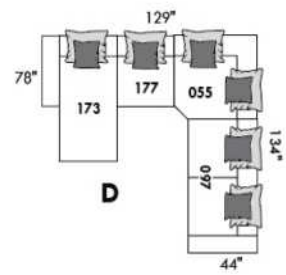
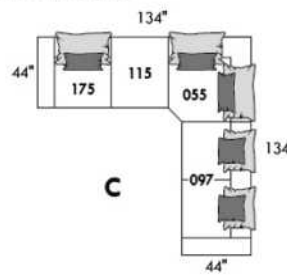
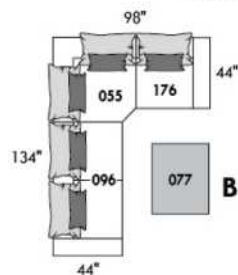
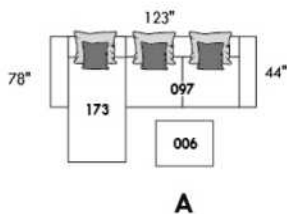

www.jaymar.ca

Toutes les dimensions indiquées sont au pouce près. Nos produits sont fabriqués à la main et des variations mineures peuvent survenir.  
 All dimensions indicated are to the nearest inch. Our product is hand-made and minor variations can occur.



## LEONARDO

### FEATURES:

- Manual adjustable headrest on all items (2 on square corner & stationary on wedge).
- \*Wall hugger power recliners with full footrest (manual n/a).
- Power recliner lounge chair (manual n/a) with power headrest in option. Wall clearance 8" & front 5".
- Seat cushions with shaped foam + 1" layer of memory foam on top; arm with memory foam.
- Stitching: Small thread in fabric & large flat thread in leather.
- \*Excludes 043 & 163 chairs: Wall clearance 16"

Note: 2 recliner seats separated by a corner can not be opened at the same time. No recliner seats beside #155 Small Square Corner.

### OPTIONS

- Battery Pack: Add \$160/ea.
- \*Motorized headrest: Add \$160 ea. (\*N/A on stationary items).
- Foam: Extra firm add \$15 /seat.
- Choice of Large or Small 6" Arm: Leg on LARGE arm: LG187 wood or LG189 metal (Black or Chrome). On SMALL 6" Arm: LG08 wood or LG64 metal. Specify colour.
- Seat Depth: 20" or \*22". \*22" seat depth N/A on chairs 043 & 163.
- 043 & 163 Chairs: with wood base (specify colour).

| Description                        | L x D x H     | Leather |                       |  |  |                                  |                           | Fabric |          |           |
|------------------------------------|---------------|---------|-----------------------|--|--|----------------------------------|---------------------------|--------|----------|-----------|
|                                    |               | 10      | 20<br>Madras<br>Softy | 30<br>Hugo<br>Fantasy<br>Illusion<br>Tucson<br>Utah<br>Vintage<br>Wild Laredo<br>Yukon | 40<br>Elegance<br>Princess<br>Santiago<br>Sensation<br>Sunset<br>Trina<br>Victoria | 50<br>Bull<br>Cassiope<br>Dublin | 60<br>Caress<br>Ultrasued | A      | B<br>COM | C<br>alta |
| 001 CHAIR                          | 43x40x33/40   | 1890    | 1980                  | 2070   | 2160   | 2250                             | 2340                      | 1535   | 1580     | 1625      |
| 002 LOVESEAT                       | 66x40x33/40   | 2700    | 2815                  | 2930   | 3045   | 3160                             | 3275                      | 2175   | 2250     | 2325      |
| 003 SOFA                           | 90x40x33/40   | 3265    | 3415                  | 3565   | 3715   | 3865                             | 4015                      | 2625   | 2715     | 2805      |
| 005 LOUNGE CHAIR RIGHT ARM         | 34x62x33/40   | 1765    | 1830                  | 1895   | 1960   | 2025                             | 2090                      | 1410   | 1470     | 1530      |
| 009 ARMLESS LOVESEAT               | 47x40x33/40   | 1895    | 1965                  | 2035   | 2105   | 2175                             | 2245                      | 1490   | 1570     | 1650      |
| 011 LOUNGE CHAIR LEFT ARM          | 34x62x33/40   | 1765    | 1830                  | 1895   | 1960   | 2025                             | 2090                      | 1410   | 1470     | 1530      |
| 012 LOVESEAT LEFT ARM              | 57x40x33/40   | 2320    | 2420                  | 2520   | 2620   | 2720                             | 2820                      | 1850   | 1925     | 2000      |
| 017 DOUBLE CHAIR                   | 50x40x33/40   | 1980    | 2080                  | 2180   | 2280   | 2380                             | 2480                      | 1600   | 1660     | 1720      |
| 021 APARTMENT SOFA NO ARM          | 61x40x33/40   | 2140    | 2240                  | 2340   | 2440   | 2540                             | 2640                      | 1670   | 1755     | 1840      |
| 040 ARMLESS SOFA                   | 71x40x33/40   | 2450    | 2565                  | 2680   | 2795   | 2910                             | 3025                      | 1950   | 2040     | 2130      |
| 041 RECLINING CHAIR LEFT ARM       | 34x40x33/40   | 1885    | 1960                  | 2035   | 2110   | 2185                             | 2260                      | 1605   | 1640     | 1675      |
| 042 RECLINING CHAIR RIGHT ARM      | 34x40x33/40   | 1885    | 1960                  | 2035   | 2110   | 2185                             | 2260                      | 1605   | 1640     | 1675      |
| 043 SWIVEL ROCKING RECLINING CHAIR | 30x34x42      | 2235    | 2345                  | 2455   | 2565   | 2675                             | 2785                      | 1875   | 1920     | 1965      |
| 044 RECLINER CHAIR                 | 43x40x33/40   | 2275    | 2365                  | 2455   | 2545   | 2635                             | 2725                      | 1920   | 1970     | 2020      |
| 045 ARMLESS LOVESEAT BUMPER RIGHT  | 68x40x33/40   | 2245    | 2340                  | 2435   | 2530   | 2625                             | 2720                      | 1785   | 1850     | 1915      |
| 050 WEDGE                          | 49x49x33      | 1645    | 1745                  | 1845   | 1945   | 2045                             | 2145                      | 1210   | 1270     | 1330      |
| 051 ARMLESS CHAIR                  | 23,5x40x33/40 | 1085    | 1135                  | 1185   | 1235   | 1285                             | 1335                      | 845    | 900      | 955       |
| 052 SOFA LEFT ARM                  | 81x40x33/40   | 2870    | 3005                  | 3140   | 3275   | 3410                             | 3545                      | 2290   | 2385     | 2480      |
| 053 SOFA RIGHT ARM                 | 81x40x33/40   | 2870    | 3005                  | 3140   | 3275   | 3410                             | 3545                      | 2290   | 2385     | 2480      |

## LEONARDO

### FEATURES:

- Manual adjustable headrest on all items (2 on square corner & stationary on wedge).
- \*Wall hugger power recliners with full footrest (manual n/a).
- Power recliner lounge chair (manual n/a) with power headrest in option. Wall clearance 8" & front 5".
- Seat cushions with shaped foam + 1" layer of memory foam on top; arm with memory foam.
- Stitching: Small thread in fabric & large flat thread in leather.
- \*Excludes 043 & 163 chairs: Wall clearance 16"

Note: 2 recliner seats separated by a corner can not be opened at the same time. No recliner seats beside #155 Small Square Corner.

### OPTIONS

- Battery Pack: Add \$160/ea.
- \*Motorized headrest: Add \$160 ea. (\*N/A on stationary items).
- Foam: Extra firm add \$15 /seat.
- Choice of Large or Small 6" Arm: Leg on LARGE arm: LG187 wood or LG189 metal (Black or Chrome). On SMALL 6" Arm: LG08 wood or LG64 metal. Specify colour.
- Seat Depth: 20" or \*22". \*22" seat depth N/A on chairs 043 & 163.
- 043 & 163 Chairs: with wood base (specify colour).

| Description                            | L x D x H     | Leather |                       |  |  |                                  |                           | Fabric |          |           |
|--|---------------|---------|-----------------------|--|--|----------------------------------|---------------------------|--------|----------|-----------|
|  |               | 10      | 20<br>Madras<br>Softy | 30<br>Hugo<br>Fantasy<br>Illusion<br>Tucson<br>Utah<br>Vintage<br>Wild Laredo<br>Yukon | 40<br>Elegance<br>Princess<br>Santiago<br>Sensation<br>Sunset<br>Trina<br>Victoria | 50<br>Bull<br>Cassiope<br>Dublin | 60<br>Caress<br>Ultrasued | A      | B<br>COM | C<br>alta |
| 055 SQUARE CORNER                      | 44x44x33/40   | 1915    | 2010                  | 2105   | 2200   | 2295                             | 2390                      | 1510   | 1565     | 1620      |
| 056 CHAIR RIGHT ARM                    | 34x40x33/40   | 1510    | 1575                  | 1640   | 1705   | 1770                             | 1835                      | 1200   | 1260     | 1320      |
| 057 CHAIR LEFT ARM                     | 34x40x33/40   | 1510    | 1575                  | 1640   | 1705   | 1770                             | 1835                      | 1200   | 1260     | 1320      |
| 061 LOVESEAT RIGHT ARM                 | 57x40x33/40   | 2320    | 2420                  | 2520   | 2620   | 2720                             | 2820                      | 1850   | 1925     | 2000      |
| 071 ARMLESS RECLINING CHAIR            | 23,5x40x33/40 | 1470    | 1525                  | 1580   | 1635   | 1690                             | 1745                      | 1250   | 1310     | 1370      |
| 086 ARMLESS LOVESEAT BUMPER LEFT       | 68x40x33/40   | 2245    | 2340                  | 2435   | 2530   | 2625                             | 2720                      | 1785   | 1850     | 1915      |
| 088 ARMLESS CHAIR BUMPER LEFT          | 45x40x33/40   | 1440    | 1535                  | 1630   | 1725   | 1820                             | 1915                      | 1130   | 1165     | 1200      |
| 089 ARMLESS CHAIR BUMPER RIGHT         | 45x40x33/40   | 1440    | 1535                  | 1630   | 1725   | 1820                             | 1915                      | 1130   | 1165     | 1200      |
| 095 APARTMENT SOFA                     | 80x40x33/40   | 2940    | 3085                  | 3230   | 3375   | 3520                             | 3665                      | 2350   | 2445     | 2540      |
| 096 APARTMENT SOFA LEFT ARM            | 71x40x33/40   | 2570    | 2680                  | 2790   | 2900   | 3010                             | 3120                      | 2020   | 2110     | 2200      |
| 097 APARTMENT SOFA RIGHT ARM           | 71x40x33/40   | 2570    | 2680                  | 2790   | 2900   | 3010                             | 3120                      | 2020   | 2110     | 2200      |
| 124 STORAGE OTTOMAN                    | 30x22x17      | 745     | 765                   | 785  | 805  | 825                              | 845                       | 650    | 670      | 690       |
| 155 SMALL SQUARE CORNER                | 40x40x33/40   | 1915    | 2010                  | 2105   | 2200   | 2295                             | 2390                      | 1510   | 1565     | 1620      |
| 163 DBL SWIVEL ROCKING RECLINER CHAIR  | 33x34x42      | 2290    | 2410                  | 2530   | 2650   | 2770                             | 2890                      | 1880   | 1930     | 1980      |
| 165 DOUBLE RECLINING CHAIR             | 50x40x33/40   | 2375    | 2475                  | 2575   | 2675   | 2775                             | 2875                      | 2000   | 2065     | 2130      |
| 167 APARTMENT SOFA NO ARM BUMPER LEFT  | 82x40x33/40   | 2490    | 2620                  | 2750   | 2880   | 3010                             | 3140                      | 1960   | 2045     | 2130      |
| 168 APARTMENT SOFA NO ARM BUMPER RIGHT | 82x40x33/40   | 2490    | 2620                  | 2750   | 2880   | 3010                             | 3140                      | 1960   | 2045     | 2130      |
| 169 DOUBLE RECLINING CHAIR LEFT ARM    | 41x40x33/40   | 1990    | 2070                  | 2150   | 2230   | 2310                             | 2390                      | 1670   | 1750     | 1830      |
| 170 DOUBLE RECLINING CHAIR RIGHT ARM   | 41x40x33/40   | 1990    | 2070                  | 2150   | 2230   | 2310                             | 2390                      | 1670   | 1750     | 1830      |
| 171 ARMLESS DOUBLE RECLINING CHAIR     | 30,5x40x33/40 | 1575    | 1625                  | 1675   | 1725   | 1775                             | 1825                      | 1320   | 1380     | 1440      |

## LEONARDO

### FEATURES:

- Manual adjustable headrest on all items (2 on square corner & stationary on wedge).
- \*Wall hugger power recliners with full footrest (manual n/a).
- Power recliner lounge chair (manual n/a) with power headrest in option. Wall clearance 8" & front 5".
- Seat cushions with shaped foam + 1" layer of memory foam on top; arm with memory foam.
- Stitching: Small thread in fabric & large flat thread in leather.
- \*Excludes 043 & 163 chairs: Wall clearance 16"

Note: 2 recliner seats separated by a corner can not be opened at the same time. No recliner seats beside #155 Small Square Corner.

### OPTIONS

- Battery Pack: Add \$160/ea.
- \*Motorized headrest: Add \$160 ea. (\*N/A on stationary items).
- Foam: Extra firm add \$15 /seat.
- Choice of Large or Small 6" Arm: Leg on LARGE arm: LG187 wood or LG189 metal (Black or Chrome). On SMALL 6" Arm: LG08 wood or LG64 metal. Specify colour.
- Seat Depth: 20" or \*22". \*22" seat depth N/A on chairs 043 & 163.
- 043 & 163 Chairs: with wood base (specify colour).

| Description                            | L x D x H     | Leather |                       |  |  |                                  |                           | Fabric |          |           |
|--|---------------|---------|-----------------------|--|--|----------------------------------|---------------------------|--------|----------|-----------|
|  |               | 10      | 20<br>Madras<br>Softy | 30<br>Hugo<br>Fantasy<br>Illusion<br>Tucson<br>Utah<br>Vintage<br>Wild Laredo<br>Yukon | 40<br>Elegance<br>Princess<br>Santiago<br>Sensation<br>Sunset<br>Trina<br>Victoria | 50<br>Bull<br>Cassiope<br>Dublin | 60<br>Caress<br>Ultrasued | A      | B<br>COM | C<br>alta |
| 173 DOUBLE LOUNGE CHAIR LEFT ARM       | 41x62x33/40   | 1915    | 2005                  | 2095   | 2185   | 2275                             | 2365                      | 1535   | 1615     | 1695      |
| 174 DOUBLE LOUNGE CHAIR RIGHT ARM      | 41x62x33/40   | 1915    | 2005                  | 2095   | 2185   | 2275                             | 2365                      | 1535   | 1615     | 1695      |
| 175 DOUBLE CHAIR LEFT ARM              | 41x40x33/40   | 1590    | 1680                  | 1770   | 1860   | 1950                             | 2040                      | 1285   | 1350     | 1415      |
| 176 DOUBLE CHAIR RIGHT ARM             | 41x40x33/40   | 1590    | 1680                  | 1770   | 1860   | 1950                             | 2040                      | 1285   | 1350     | 1415      |
| 177 ARMLESS DOUBLE CHAIR               | 30,5x40x33/40 | 1185    | 1250                  | 1315   | 1380   | 1445                             | 1510                      | 915    | 970      | 1025      |
| 178 ARMLESS DOUBLE CHAIR BUMPER LEFT   | 52x40x33/40   | 1545    | 1625                  | 1705   | 1785   | 1865                             | 1945                      | 1230   | 1290     | 1350      |
| 179 ARMLESS DOUBLE CHAIR BUMPER RIGHT  | 52x40x33/40   | 1545    | 1625                  | 1705   | 1785   | 1865                             | 1945                      | 1230   | 1290     | 1350      |
| 186 ARMLESS LOVESEAT BUMPER STORAGE-L  | 68x40x33/40   | 2420    | 2500                  | 2580   | 2660   | 2740                             | 2820                      | 1950   | 2015     | 2080      |
| 187 ARMLESS LOVESEAT BUMPER STORAGE-R  | 68x40x33/40   | 2420    | 2500                  | 2580   | 2660   | 2740                             | 2820                      | 1950   | 2015     | 2080      |
| 188 ARMLESS CHAIR BUMPER STORAGE-L     | 45x40x33/40   | 1600    | 1690                  | 1780   | 1870   | 1960                             | 2050                      | 1295   | 1330     | 1365      |
| 189 ARMLESS CHAIR BUMPER STORAGE-R     | 45x40x33/40   | 1600    | 1690                  | 1780   | 1870   | 1960                             | 2050                      | 1295   | 1330     | 1365      |
| 221 ARMLESS DBL CHAIR BUMPER STORAGE-L | 52x40x33/40   | 1705    | 1790                  | 1875   | 1960   | 2045                             | 2130                      | 1390   | 1450     | 1510      |
| 222 ARMLESS DBL CHAIR BUMPER STORAGE-R | 52x40x33/40   | 1705    | 1790                  | 1875   | 1960   | 2045                             | 2130                      | 1390   | 1450     | 1510      |
| 223 APT SOFA NO ARM BUMPER STORAGE-L   | 82x40x33/40   | 2655    | 2785                  | 2915   | 3045   | 3175                             | 3305                      | 2120   | 2215     | 2310      |
| 224 APT SOFA NO ARM BUMPER STORAGE-R   | 82x40x33/40   | 2655    | 2785                  | 2915   | 3045   | 3175                             | 3305                      | 2120   | 2215     | 2310      |
| 236 RECLINING LOUNGE CHAIR LEFT ARM    | 34x62x33/40   | 2160    | 2225                  | 2290   | 2355   | 2420                             | 2485                      | 1820   | 1880     | 1940      |
| 237 RECLINING LOUNGE CHAIR RIGHT ARM   | 34x62x33/40   | 2160    | 2225                  | 2290   | 2355   | 2420                             | 2485                      | 1820   | 1880     | 1940      |
| 238 RECLINING DBL LOUNGE CHAIR L-ARM   | 41x62x33/40   | 2315    | 2405                  | 2495   | 2585   | 2675                             | 2765                      | 1940   | 2020     | 2100      |
| 239 RECLINING DBL LOUNGE CHAIR R-ARM   | 41x62x33/40   | 2315    | 2405                  | 2495   | 2585   | 2675                             | 2765                      | 1940   | 2020     | 2100      |
| <b>CONFIGURATIONS</b>                  |               |         |                       |  |  |                                  |                           |        |          |           |

## CDN Price List

### LEONARDO

| Description                | L x D x H  | Leather |                       |  |  |                                  |                           | Fabric |          |           |
|----------------------------|------------|---------|-----------------------|--|--|----------------------------------|---------------------------|--------|----------|-----------|
|                            |            | 10      | 20<br>Madras<br>Softy | 30<br>Hugo<br>Fantasy<br>Illusion<br>Tucson<br>Utah<br>Vintage<br>Wild Laredo<br>Yukon | 40<br>Elegance<br>Princess<br>Santiago<br>Sensation<br>Sunset<br>Trina<br>Victoria | 50<br>Bull<br>Cassiope<br>Dublin | 60<br>Caress<br>Ultrasued | A      | B<br>COM | C<br>alta |
| A CONFIG (169-170)         | 81X40X40   | 3980    | 4140                  | 4300   | 4460   | 4620                             | 4780                      | 3340   | 3500     | 3660      |
| B CONFIG (169-171-174)     | 113X62X40  | 5480    | 5700                  | 5920   | 6140   | 6360                             | 6580                      | 4525   | 4745     | 4965      |
| C CONFIG (096-055-171-170) | 116X116X40 | 8050    | 8385                  | 8720   | 9055   | 9390                             | 9725                      | 6520   | 6805     | 7090      |
| D CONFIG (169-171-055-179) | 116X96X40  | 7025    | 7330                  | 7635   | 7940   | 8245                             | 8550                      | 5730   | 5985     | 6240      |
| J CONFIG (041-042)         | 67X40X40   | 3770    | 3920                  | 4070   | 4220   | 4370                             | 4520                      | 3210   | 3280     | 3350      |
| K CONFIG (041-071-005)     | 92X62X40   | 5120    | 5315                  | 5510   | 5705   | 5900                             | 6095                      | 4265   | 4420     | 4575      |
| L CONFIG (012-055-071-042) | 102X102X40 | 7590    | 7915                  | 8240   | 8565   | 8890                             | 9215                      | 6215   | 6440     | 6665      |
| M CONFIG (041-071-055-089) | 102X89X40  | 6710    | 7030                  | 7350   | 7670   | 7990                             | 8310                      | 5495   | 5680     | 5865      |





# LEONARDO

**OPTIMA**  
Collection

**Jaymar**

Conçu et fabriqué fièrement au Canada  
Proudly designed and made in Canada

Nos produits sont fabriqués à la main et des variations mineures peuvent survenir

Our product is hand-made and minor variations can occur.

## SPECIFICATIONS

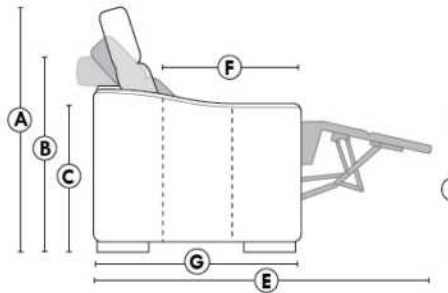

- Appui-tête levé / Headrest up
- Appui-tête baissé / Headrest down
- Complètement incliné / Fully reclined

- A** Hauteur complète 40" Total Height
- B** Hauteur appui-tête baissé 33" Height headrest down
- C** Hauteur du bras 24" Arm Height
- D** Hauteur du siège 19,5" Seat height
- E** Profondeur inclinée 65" Depth fully reclined
- F** Profondeur d'assise 20"ou/ou 22" Seat depth
- G** Profondeur appui-tête monté 37,5" Depth with headrest up

## BRAS | ARMS

Option de bras:  
Bras Régulier Large 9,5" ou Petit bras 6"

Arm option  
Regular arm Large 9.5" or Small arm 6"

Contrôle de l'inclinaison situé à l'extérieur du bras  
Recliner control located on the outside of the arm.

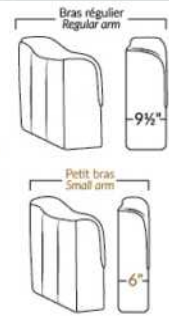

## FAUTEUIL BERÇANT PIVOTANT INCLINABLE SWIVEL ROCKING MOTION CHAIR

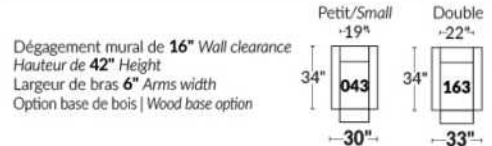

## SIÈGE 23" DE LARGE | 23" SEAT WIDTH

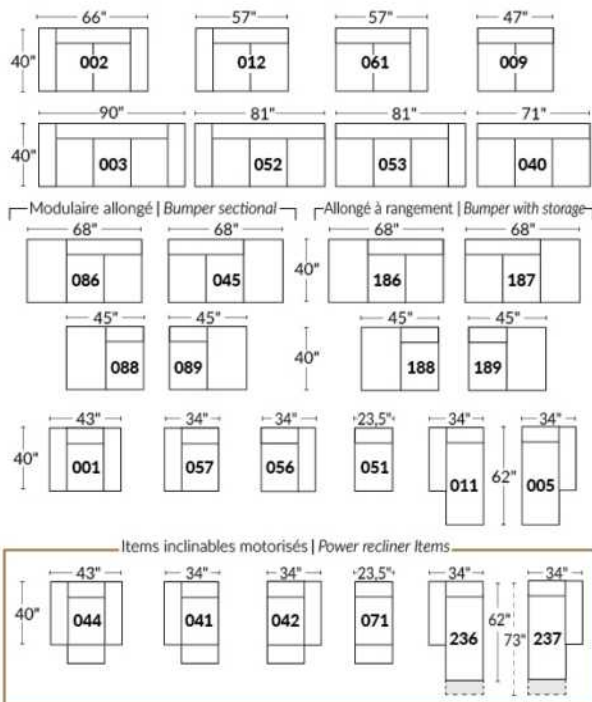

## SIÈGE 30" DE LARGE | 30" SEAT WIDTH

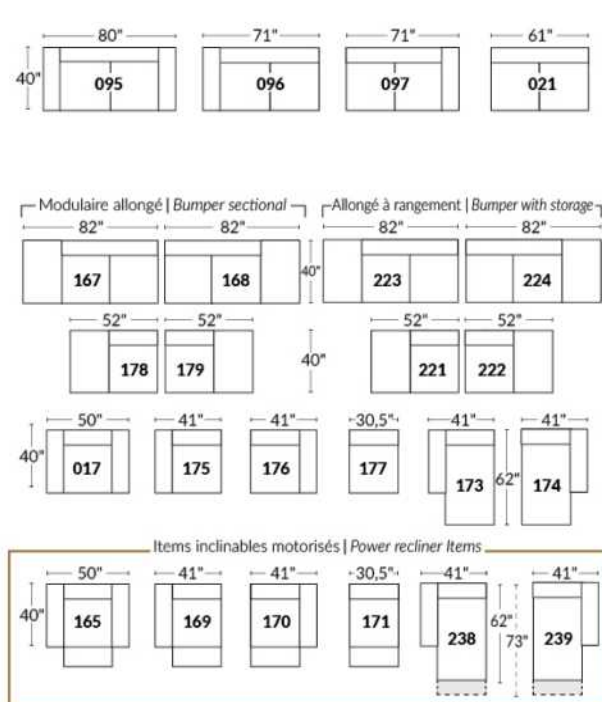

### Autres | Others

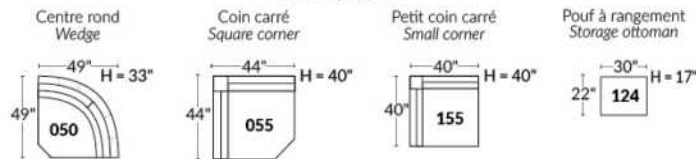

## EXEMPLE 23" EXAMPLE

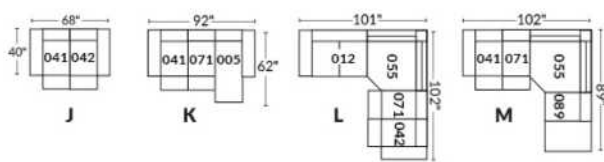

## EXEMPLE 30" EXAMPLE

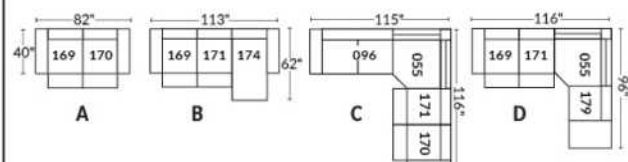

## CDN Price List

### LIMBO

LEGS: Specify colour of legs LG6.  
COMBO: Cover #2 on back only. PLAIN FABRIC RECOMMENDED.

| Description                         | L x D x H    | Leather |                       |  |  |                                  |                           | Fabric |          |           |
|-------------------------------------|--------------|---------|-----------------------|--|--|----------------------------------|---------------------------|--------|----------|-----------|
|                                     |              | 10      | 20<br>Madras<br>Softy | 30<br>Hugo<br>Fantasy<br>Illusion<br>Tucson<br>Utah<br>Vintage<br>Wild Laredo<br>Yukon | 40<br>Elegance<br>Princess<br>Santiago<br>Sensation<br>Sunset<br>Trina<br>Victoria | 50<br>Bull<br>Cassiope<br>Dublin | 60<br>Caress<br>Ultrasued | A      | B<br>COM | C<br>alta |
| 001 CHAIR                           | 41X36X34     | 1405    | 1495                  | 1585   | 1675   | 1765                             | 1855                      | 1040   | 1095     | 1150      |
| 002 LOVESEAT                        | 64X36X34     | 1875    | 1995                  | 2115   | 2235   | 2355                             | 2475                      | 1360   | 1435     | 1510      |
| 003 SOFA                            | 87X36X34     | 2180    | 2335                  | 2490   | 2645   | 2800                             | 2955                      | 1635   | 1735     | 1835      |
| 005 LOUNGE CHAIR RIGHT ARM          | 32X60X34     | 1630    | 1750                  | 1870   | 1990   | 2110                             | 2230                      | 1130   | 1195     | 1260      |
| 006 OTTOMAN                         | 25.5X25.5X18 | 620     | 680                   | 740  | 800  | 860                              | 920                       | 535    | 545      | 555       |
| 009 ARMLESS LOVESEAT                | 46X36X34     | 1560    | 1675                  | 1790   | 1905   | 2020                             | 2135                      | 1155   | 1240     | 1325      |
| 011 LOUNGE CHAIR LEFT ARM           | 32X60X34     | 1630    | 1750                  | 1870   | 1990   | 2110                             | 2230                      | 1130   | 1195     | 1260      |
| 012 LOVESEAT LEFT ARM               | 55X36X34     | 1650    | 1780                  | 1910   | 2040   | 2170                             | 2300                      | 1255   | 1330     | 1405      |
| 024 SECTIONAL LOVESEAT BUMPER RIGHT | 79X36X34     | 1735    | 1840                  | 1945   | 2050   | 2155                             | 2260                      | 1325   | 1385     | 1445      |
| 048 SECTIONAL LOVESEAT BUMPER LEFT  | 79X36X34     | 1735    | 1840                  | 1945   | 2050   | 2155                             | 2260                      | 1325   | 1385     | 1445      |
| 050 WEDGE                           | 48X48X34     | 1390    | 1495                  | 1600   | 1705   | 1810                             | 1915                      | 1130   | 1175     | 1220      |
| 052 SOFA LEFT ARM                   | 78X36X34     | 1980    | 2130                  | 2280   | 2430   | 2580                             | 2730                      | 1535   | 1620     | 1705      |
| 053 SOFA RIGHT ARM                  | 78X36X34     | 1980    | 2130                  | 2280   | 2430   | 2580                             | 2730                      | 1535   | 1620     | 1705      |
| 055 SQUARE CORNER                   | 35X35X34     | 1345    | 1450                  | 1555   | 1660   | 1765                             | 1870                      | 1040   | 1100     | 1160      |
| 056 CHAIR RIGHT ARM                 | 32X36X34     | 1260    | 1295                  | 1330   | 1365   | 1400                             | 1435                      | 950    | 1000     | 1050      |
| 057 CHAIR LEFT ARM                  | 32X36X34     | 1260    | 1295                  | 1330   | 1365   | 1400                             | 1435                      | 950    | 1000     | 1050      |
| 061 LOVESEAT RIGHT ARM              | 55X36X34     | 1650    | 1780                  | 1910   | 2040   | 2170                             | 2300                      | 1255   | 1330     | 1405      |
| 095 APARTMENT SOFA                  | 79X36X34     | 2070    | 2205                  | 2340   | 2475   | 2610                             | 2745                      | 1575   | 1650     | 1725      |
| <b>CONFIGURATIONS</b>               |              |         |                       |  |  |                                  |                           |        |          |           |
| A CONF. A (052-005)                 | 110X60X34    | 3610    | 3880                  | 4150   | 4420   | 4690                             | 4960                      | 2665   | 2815     | 2965      |
| B CONF. B (048-053)                 | 114X79X34    | 3715    | 3970                  | 4225   | 4480   | 4735                             | 4990                      | 2860   | 3005     | 3150      |
| C CONF. C (012-050-061)             | 103X103X34   | 4690    | 5055                  | 5420   | 5785   | 6150                             | 6515                      | 3640   | 3835     | 4030      |
| D CONF. D (011-009-024)             | 114X79X34    | 4925    | 5265                  | 5605   | 5945   | 6285                             | 6625                      | 3610   | 3820     | 4030      |
| E CONF. E (057-024)                 | 79X68X34     | 2995    | 3135                  | 3275   | 3415   | 3555                             | 3695                      | 2275   | 2385     | 2495      |
| F CONF. F (003-001-006)             | 87X36X34     | 4205    | 4510                  | 4815   | 5120   | 5425                             | 5730                      | 3210   | 3375     | 3540      |

# LIMBO



Hauteur complète 34" | Hauteur de siège 18" | Profondeur d'assise 21"  
 Total Height 34" | Seat Height 18" | Seat Depth 21"

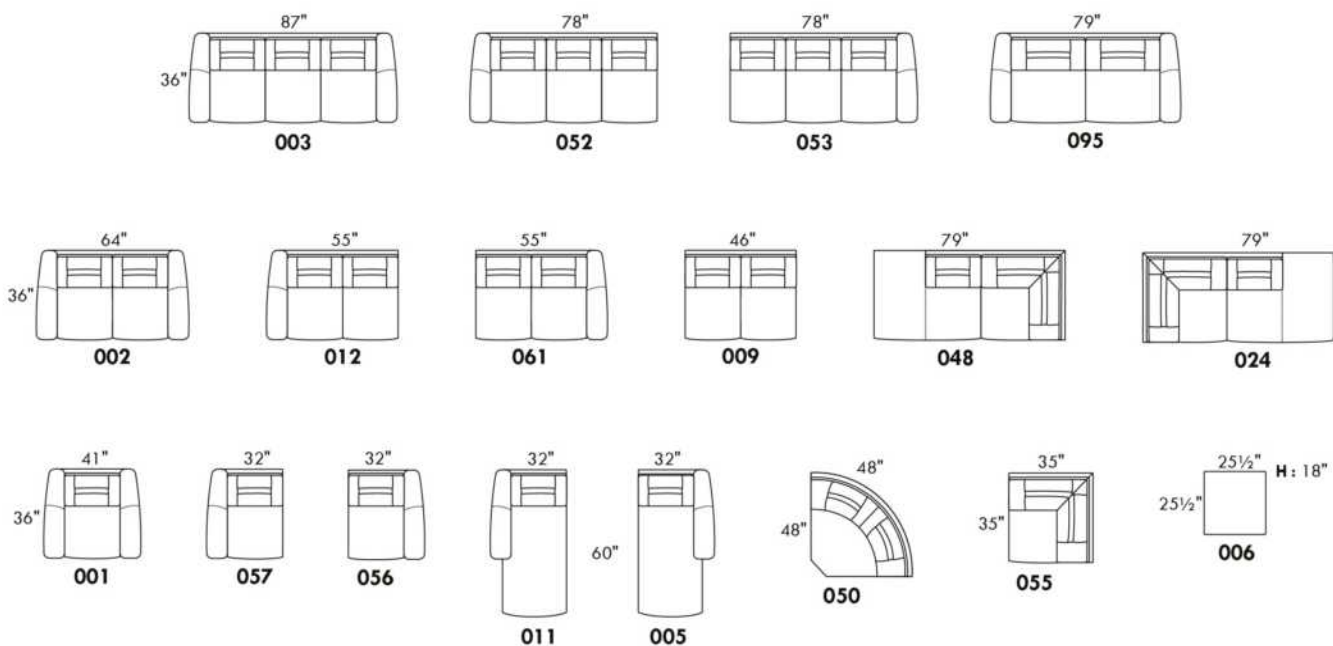

## CONFIGURATIONS

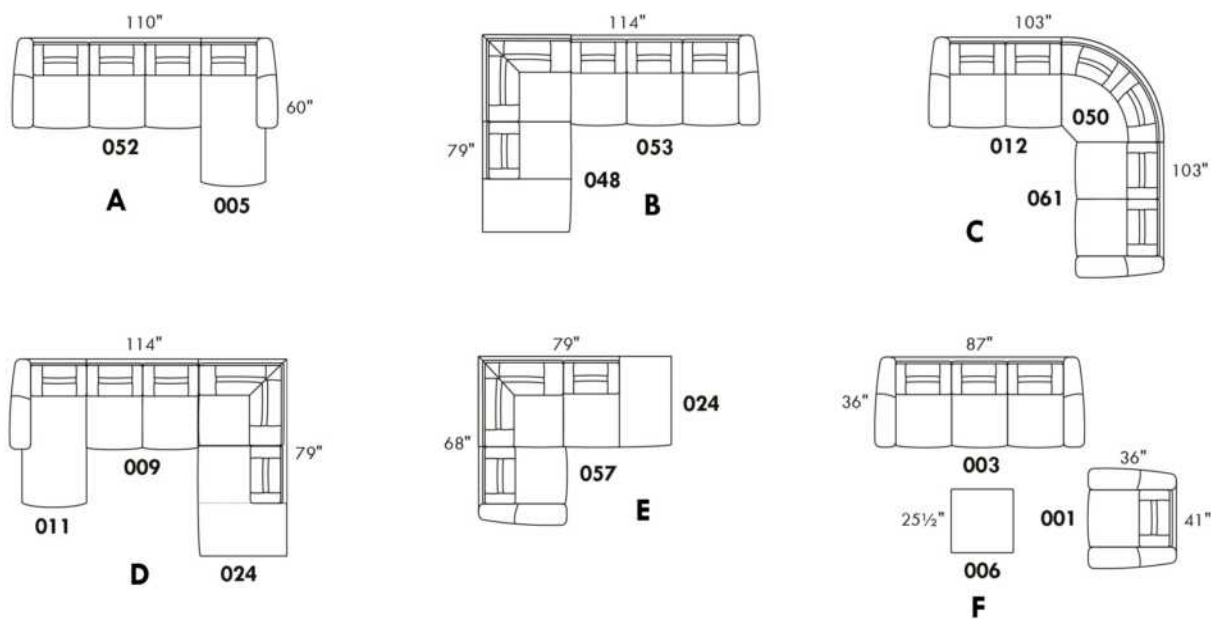

www.jaymar.ca

Toutes les dimensions indiquées sont au pouce près. Nos produits sont fabriqués à la main et des variations mineures peuvent survenir.  
 All dimensions indicated are to the nearest inch. Our product is hand-made and minor variations can occur.

## LUCAS

FEATURES: Upholstered seat cushions with high quality 2.5 lb. density shaped foam and a 1" layer of memory foam.

LEG: Wood leg LG161 round or LG4 square; specify colour. Metal leg: LG82.

RECOMMENDED in PLAIN FABRIC only. In fabric, the decorative stitching will be the same as in leather except with a thinner thread.

IN LEATHER available with CONTRASTING THREAD: Upcharge \$50/piece. Specify thread No.: Black 005, Beige 087, Brown 103, White 111.

| Description                       | L x D x H      | Leather |                       |  |  |                                  |                           | Fabric |          |           |
|-----------------------------------|----------------|---------|-----------------------|--|--|----------------------------------|---------------------------|--------|----------|-----------|
|                                   |                | 10      | 20<br>Madras<br>Softy | 30<br>Hugo<br>Fantasy<br>Illusion<br>Tucson<br>Utah<br>Vintage<br>Wild Laredo<br>Yukon | 40<br>Elegance<br>Princess<br>Santiago<br>Sensation<br>Sunset<br>Trina<br>Victoria | 50<br>Bull<br>Cassiope<br>Dublin | 60<br>Caress<br>Ultrasued | A      | B<br>COM | C<br>alta |
| 001 CHAIR                         | 41X40X34       | 1795    | 1885                  | 1975   | 2065   | 2155                             | 2245                      | 1285   | 1340     | 1395      |
| 002 LOVESEAT                      | 67X40X34       | 2495    | 2625                  | 2755   | 2885   | 3015                             | 3145                      | 1805   | 1885     | 1965      |
| 005 LOUNGE CHAIR RIGHT ARM        | 33.5X67X34     | 1910    | 2030                  | 2150   | 2270   | 2390                             | 2510                      | 1575   | 1650     | 1725      |
| 006 OTTOMAN                       | 25.5X25.5X17.5 | 660     | 690                   | 720  | 750  | 780                              | 810                       | 505    | 525      | 545       |
| 009 ARMLESS LOVESEAT              | 52X40X34       | 1910    | 2030                  | 2150   | 2270   | 2390                             | 2510                      | 1610   | 1675     | 1740      |
| 011 LOUNGE CHAIR LEFT ARM         | 33.5X67X34     | 1910    | 2030                  | 2150   | 2270   | 2390                             | 2510                      | 1575   | 1650     | 1725      |
| 012 LOVESEAT LEFT ARM             | 59.5X40X34     | 2215    | 2335                  | 2455   | 2575   | 2695                             | 2815                      | 1720   | 1800     | 1880      |
| 045 ARMLESS LOVESEAT BUMPER RIGHT | 72X40X34       | 2215    | 2335                  | 2455   | 2575   | 2695                             | 2815                      | 1720   | 1800     | 1880      |
| 050 WEDGE                         | 51X51X34       | 1765    | 1865                  | 1965   | 2065   | 2165                             | 2265                      | 1480   | 1575     | 1670      |
| 051 ARMLESS CHAIR                 | 26X40X34       | 1185    | 1285                  | 1385   | 1485   | 1585                             | 1685                      | 1055   | 1130     | 1205      |
| 055 SQUARE CORNER                 | 40X40X34       | 1700    | 1790                  | 1880   | 1970   | 2060                             | 2150                      | 1385   | 1475     | 1565      |
| 056 CHAIR RIGHT ARM               | 33.5X40X34     | 1505    | 1590                  | 1675   | 1760   | 1845                             | 1930                      | 1155   | 1225     | 1295      |
| 057 CHAIR LEFT ARM                | 33.5X40X34     | 1505    | 1590                  | 1675   | 1760   | 1845                             | 1930                      | 1155   | 1225     | 1295      |
| 061 LOVESEAT RIGHT ARM            | 59.5X40X34     | 2215    | 2335                  | 2455   | 2575   | 2695                             | 2815                      | 1720   | 1800     | 1880      |
| 086 ARMLESS LOVESEAT BUMPER LEFT  | 72X40X34       | 2215    | 2335                  | 2455   | 2575   | 2695                             | 2815                      | 1720   | 1800     | 1880      |
| 088 ARMLESS CHAIR BUMPER LEFT     | 46X40X34       | 1505    | 1590                  | 1675   | 1760   | 1845                             | 1930                      | 1155   | 1225     | 1295      |
| 089 ARMLESS CHAIR BUMPER RIGHT    | 46X40X34       | 1505    | 1590                  | 1675   | 1760   | 1845                             | 1930                      | 1155   | 1225     | 1295      |
| 095 APARTMENT SOFA                | 82X40X34       | 2805    | 2940                  | 3075   | 3210   | 3345                             | 3480                      | 1975   | 2070     | 2165      |
| 096 APARTMENT SOFA LEFT ARM       | 74.5X40X34     | 2490    | 2645                  | 2800   | 2955   | 3110                             | 3265                      | 1870   | 1975     | 2080      |
| 097 APARTMENT SOFA RIGHT ARM      | 74.5X40X34     | 2490    | 2645                  | 2800   | 2955   | 3110                             | 3265                      | 1870   | 1975     | 2080      |
| <b>CONFIGURATIONS</b>             |                |         |                       |  |  |                                  |                           |        |          |           |
| A CONF. A (12-50-61)              | 110.5X110X5X34 | 6195    | 6535                  | 6875   | 7215   | 7555                             | 7895                      | 4920   | 5175     | 5430      |
| B CONF. B (88-55-61)              | 86X99.5X34     | 5420    | 5715                  | 6010   | 6305   | 6600                             | 6895                      | 4260   | 4500     | 4740      |
| C CONF. C (11-97)                 | 67X108X34      | 4400    | 4675                  | 4950   | 5225   | 5500                             | 5775                      | 3445   | 3625     | 3805      |
| D CONF. D (96-05)                 | 108X67X34      | 4400    | 4675                  | 4950   | 5225   | 5500                             | 5775                      | 3445   | 3625     | 3805      |
| E CONF. E (12-50-89)              | 110.5X97X34    | 5485    | 5790                  | 6095   | 6400   | 6705                             | 7010                      | 4355   | 4600     | 4845      |
| F CONF. F (96-55-89)              | 114.5X86X34    | 5695    | 6025                  | 6355   | 6685   | 7015                             | 7345                      | 4410   | 4675     | 4940      |

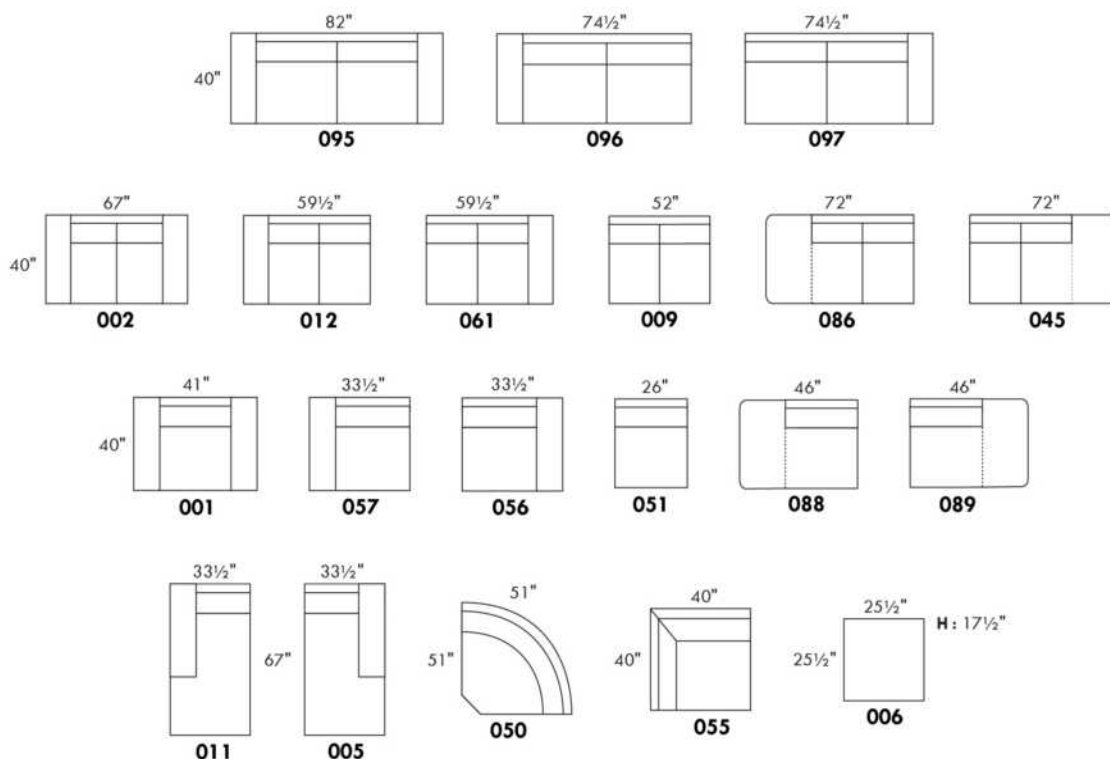

## CONFIGURATIONS

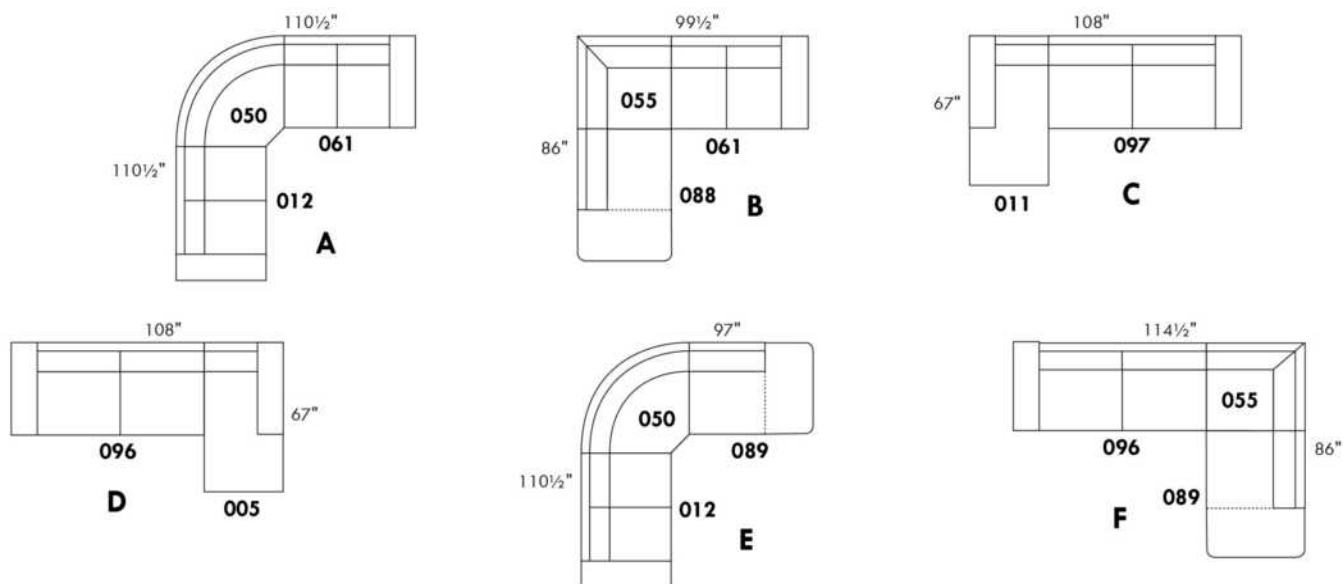

www.jaymar.ca

Toutes les dimensions indiquées sont au pouce près. Nos produits sont fabriqués à la main et des variations mineures peuvent survenir.  
 All dimensions indicated are to the nearest inch. Our product is hand-made and minor variations can occur.

## LYON

### FEATURES:

- Manual adjustable headrest on all items (2 on square corner & stationary on wedge).
- \*Wall hugger power recliners with full footrest (manual n/a).
- Power recliner lounge chair (manual n/a) with power headrest in option. Wall clearance 8" & front 5".
- Seat cushions with shaped foam + 1" layer of memory foam on top.
- Stitching: Small thread in fabric & large flat thread in leather.
- \*Excludes 043 & 163 chairs: Wall clearance 16"

Note: 2 recliner seats separated by a corner can not be opened at the same time. No recliner seats beside #155 Small Square Corner.

### OPTIONS

- Battery Pack: Add \$160/ea.
- \*Motorized headrest: Add \$160 ea. (\*N/A on stationary items).
- Foam: Extra firm add \$15/seat.
- Choice of Large or Small 6" Arm: Leg on LARGE arm: LG08 wood. Leg on SMALL Arm: LG195 wood. Specify colour of wood leg.
- Seat Depth: 20" or \*22". \*22" seat depth N/A on chairs 043 & 163.
- 043 & 163 Chairs: with wood base (specify colour).

| Description                        | L x D x H     | Leather |                       |  |  |                                  |                           | Fabric |          |           |
|------------------------------------|---------------|---------|-----------------------|--|--|----------------------------------|---------------------------|--------|----------|-----------|
|                                    |               | 10      | 20<br>Madras<br>Softy | 30<br>Hugo<br>Fantasy<br>Illusion<br>Tucson<br>Utah<br>Vintage<br>Wild Laredo<br>Yukon | 40<br>Elegance<br>Princess<br>Santiago<br>Sensation<br>Sunset<br>Trina<br>Victoria | 50<br>Bull<br>Cassiope<br>Dublin | 60<br>Caress<br>Ultrasued | A      | B<br>COM | C<br>alta |
| 001 CHAIR                          | 40x40x33/40   | 1890    | 1980                  | 2070   | 2160   | 2250                             | 2340                      | 1535   | 1580     | 1625      |
| 002 LOVESEAT                       | 63x40x33/40   | 2700    | 2815                  | 2930   | 3045   | 3160                             | 3275                      | 2175   | 2250     | 2325      |
| 003 SOFA                           | 87x40x33/40   | 3265    | 3415                  | 3565   | 3715   | 3865                             | 4015                      | 2625   | 2715     | 2805      |
| 005 LOUNGE CHAIR RIGHT ARM         | 32x62x33/40   | 1765    | 1830                  | 1895   | 1960   | 2025                             | 2090                      | 1410   | 1470     | 1530      |
| 009 ARMLESS LOVESEAT               | 47x40x33/40   | 1895    | 1965                  | 2035   | 2105   | 2175                             | 2245                      | 1490   | 1570     | 1650      |
| 011 LOUNGE CHAIR LEFT ARM          | 32x62x33/40   | 1765    | 1830                  | 1895   | 1960   | 2025                             | 2090                      | 1410   | 1470     | 1530      |
| 012 LOVESEAT LEFT ARM              | 55x40x33/40   | 2320    | 2420                  | 2520   | 2620   | 2720                             | 2820                      | 1850   | 1925     | 2000      |
| 017 DOUBLE CHAIR                   | 47x40x33/40   | 1980    | 2080                  | 2180   | 2280   | 2380                             | 2480                      | 1600   | 1660     | 1720      |
| 021 APARTMENT SOFA NO ARM          | 61x40x33/40   | 2140    | 2240                  | 2340   | 2440   | 2540                             | 2640                      | 1670   | 1755     | 1840      |
| 040 ARMLESS SOFA                   | 71x40x33/40   | 2450    | 2565                  | 2680   | 2795   | 2910                             | 3025                      | 1950   | 2040     | 2130      |
| 041 RECLINING CHAIR LEFT ARM       | 32x40x33/40   | 1885    | 1960                  | 2035   | 2110   | 2185                             | 2260                      | 1605   | 1640     | 1675      |
| 042 RECLINING CHAIR RIGHT ARM      | 32x40x33/40   | 1885    | 1960                  | 2035   | 2110   | 2185                             | 2260                      | 1605   | 1640     | 1675      |
| 043 SWIVEL ROCKING RECLINING CHAIR | 30/33x34x42   | 2235    | 2345                  | 2455   | 2565   | 2675                             | 2785                      | 1875   | 1920     | 1965      |
| 044 RECLINER CHAIR                 | 40x40x33/40   | 2275    | 2365                  | 2455   | 2545   | 2635                             | 2725                      | 1920   | 1970     | 2020      |
| 045 ARMLESS LOVESEAT BUMPER RIGHT  | 68x40x33/40   | 2245    | 2340                  | 2435   | 2530   | 2625                             | 2720                      | 1785   | 1850     | 1915      |
| 050 WEDGE                          | 49x49x33      | 1645    | 1745                  | 1845   | 1945   | 2045                             | 2145                      | 1210   | 1270     | 1330      |
| 051 ARMLESS CHAIR                  | 23,5x40x33/40 | 1085    | 1135                  | 1185   | 1235   | 1285                             | 1335                      | 845    | 900      | 955       |
| 052 SOFA LEFT ARM                  | 79x40x33/40   | 2870    | 3005                  | 3140   | 3275   | 3410                             | 3545                      | 2290   | 2385     | 2480      |
| 053 SOFA RIGHT ARM                 | 79x40x33/40   | 2870    | 3005                  | 3140   | 3275   | 3410                             | 3545                      | 2290   | 2385     | 2480      |

## LYON

### FEATURES:

- Manual adjustable headrest on all items (2 on square corner & stationary on wedge).
- \*Wall hugger power recliners with full footrest (manual n/a).
- Power recliner lounge chair (manual n/a) with power headrest in option. Wall clearance 8" & front 5".
- Seat cushions with shaped foam + 1" layer of memory foam on top.
- Stitching: Small thread in fabric & large flat thread in leather.
- \*Excludes 043 & 163 chairs: Wall clearance 16"

Note: 2 recliner seats separated by a corner can not be opened at the same time. No recliner seats beside #155 Small Square Corner.

### OPTIONS

- Battery Pack: Add \$160/ea.
- \*Motorized headrest: Add \$160 ea. (\*N/A on stationary items).
- Foam: Extra firm add \$15/seat.
- Choice of Large or Small 6" Arm: Leg on LARGE arm: LG08 wood. Leg on SMALL Arm: LG195 wood. Specify colour of wood leg.
- Seat Depth: 20" or \*22". \*22" seat depth N/A on chairs 043 & 163.
- 043 & 163 Chairs: with wood base (specify colour).

| Description                            | L x D x H      | Leather |                       |  |  |                                  |                           | Fabric |          |           |
|--|----------------|---------|-----------------------|--|--|----------------------------------|---------------------------|--------|----------|-----------|
|  |                | 10      | 20<br>Madras<br>Softy | 30<br>Hugo<br>Fantasy<br>Illusion<br>Tucson<br>Utah<br>Vintage<br>Wild Laredo<br>Yukon | 40<br>Elegance<br>Princess<br>Santiago<br>Sensation<br>Sunset<br>Trina<br>Victoria | 50<br>Bull<br>Cassiope<br>Dublin | 60<br>Caress<br>Ultrasued | A      | B<br>COM | C<br>alta |
| 055 SQUARE CORNER                      | 44x44x33/40    | 1915    | 2010                  | 2105   | 2200   | 2295                             | 2390                      | 1510   | 1565     | 1620      |
| 056 CHAIR RIGHT ARM                    | 32x40x33/40    | 1510    | 1575                  | 1640   | 1705   | 1770                             | 1835                      | 1200   | 1260     | 1320      |
| 057 CHAIR LEFT ARM                     | 32x40x33/40    | 1510    | 1575                  | 1640   | 1705   | 1770                             | 1835                      | 1200   | 1260     | 1320      |
| 061 LOVESEAT RIGHT ARM                 | 55x40x33/40    | 2320    | 2420                  | 2520   | 2620   | 2720                             | 2820                      | 1850   | 1925     | 2000      |
| 071 ARMLESS RECLINING CHAIR            | 23,5x40x33/40  | 1470    | 1525                  | 1580   | 1635   | 1690                             | 1745                      | 1250   | 1310     | 1370      |
| 086 ARMLESS LOVESEAT BUMPER LEFT       | 68x40x33/40    | 2245    | 2340                  | 2435   | 2530   | 2625                             | 2720                      | 1785   | 1850     | 1915      |
| 088 ARMLESS CHAIR BUMPER LEFT          | 45x40x33/40    | 1440    | 1535                  | 1630   | 1725   | 1820                             | 1915                      | 1130   | 1165     | 1200      |
| 089 ARMLESS CHAIR BUMPER RIGHT         | 45x40x33/40    | 1440    | 1535                  | 1630   | 1725   | 1820                             | 1915                      | 1130   | 1165     | 1200      |
| 095 APARTMENT SOFA                     | 77x40x33/40    | 2940    | 3085                  | 3230   | 3375   | 3520                             | 3665                      | 2350   | 2445     | 2540      |
| 096 APARTMENT SOFA LEFT ARM            | 69x40x33/40    | 2570    | 2680                  | 2790   | 2900   | 3010                             | 3120                      | 2020   | 2110     | 2200      |
| 097 APARTMENT SOFA RIGHT ARM           | 69x40x33/40    | 2570    | 2680                  | 2790   | 2900   | 3010                             | 3120                      | 2020   | 2110     | 2200      |
| 124 STORAGE OTTOMAN                    | 30x22x17       | 745     | 765                   | 785  | 805  | 825                              | 845                       | 650    | 670      | 690       |
| 155 SMALL SQUARE CORNER                | 40x40x33/40    | 1915    | 2010                  | 2105   | 2200   | 2295                             | 2390                      | 1510   | 1565     | 1620      |
| 163 DBL SWIVEL ROCKING RECLINER CHAIR  | 33/36x40x33/40 | 2290    | 2410                  | 2530   | 2650   | 2770                             | 2890                      | 1880   | 1930     | 1980      |
| 165 DOUBLE RECLINING CHAIR             | 47x40x33/40    | 2375    | 2475                  | 2575   | 2675   | 2775                             | 2875                      | 2000   | 2065     | 2130      |
| 167 APARTMENT SOFA NO ARM BUMPER LEFT  | 82x40x33/40    | 2490    | 2620                  | 2750   | 2880   | 3010                             | 3140                      | 1960   | 2045     | 2130      |
| 168 APARTMENT SOFA NO ARM BUMPER RIGHT | 82x40x33/40    | 2490    | 2620                  | 2750   | 2880   | 3010                             | 3140                      | 1960   | 2045     | 2130      |
| 169 DOUBLE RECLINING CHAIR LEFT ARM    | 39x40x33/40    | 1990    | 2070                  | 2150   | 2230   | 2310                             | 2390                      | 1670   | 1750     | 1830      |
| 170 DOUBLE RECLINING CHAIR RIGHT ARM   | 39x40x33/40    | 1990    | 2070                  | 2150   | 2230   | 2310                             | 2390                      | 1670   | 1750     | 1830      |
| 171 ARMLESS DOUBLE RECLINING CHAIR     | 30,5x40x33/40  | 1575    | 1625                  | 1675   | 1725   | 1775                             | 1825                      | 1320   | 1380     | 1440      |

## LYON

### FEATURES:

- Manual adjustable headrest on all items (2 on square corner & stationary on wedge).
- \*Wall hugger power recliners with full footrest (manual n/a).
- Power recliner lounge chair (manual n/a) with power headrest in option. Wall clearance 8" & front 5".
- Seat cushions with shaped foam + 1" layer of memory foam on top.
- Stitching: Small thread in fabric & large flat thread in leather.
- \*Excludes 043 & 163 chairs: Wall clearance 16"

Note: 2 recliner seats separated by a corner can not be opened at the same time. No recliner seats beside #155 Small Square Corner.

### OPTIONS

- Battery Pack: Add \$160/ea.
- \*Motorized headrest: Add \$160 ea. (\*N/A on stationary items).
- Foam: Extra firm add \$15/seat.
- Choice of Large or Small 6" Arm: Leg on LARGE arm: LG08 wood. Leg on SMALL Arm: LG195 wood. Specify colour of wood leg.
- Seat Depth: 20" or \*22". \*22" seat depth N/A on chairs 043 & 163.
- 043 & 163 Chairs: with wood base (specify colour).

| Description                            | L x D x H     | Leather |                       |  |  |                                  |                           | Fabric |          |           |
|--|---------------|---------|-----------------------|--|--|----------------------------------|---------------------------|--------|----------|-----------|
|  |               | 10      | 20<br>Madras<br>Softy | 30<br>Hugo<br>Fantasy<br>Illusion<br>Tucson<br>Utah<br>Vintage<br>Wild Laredo<br>Yukon | 40<br>Elegance<br>Princess<br>Santiago<br>Sensation<br>Sunset<br>Trina<br>Victoria | 50<br>Bull<br>Cassiope<br>Dublin | 60<br>Caress<br>Ultrasued | A      | B<br>COM | C<br>alta |
| 173 DOUBLE LOUNGE CHAIR LEFT ARM       | 39x62x33/40   | 1915    | 2005                  | 2095   | 2185   | 2275                             | 2365                      | 1535   | 1615     | 1695      |
| 174 DOUBLE LOUNGE CHAIR RIGHT ARM      | 39x62x33/40   | 1915    | 2005                  | 2095   | 2185   | 2275                             | 2365                      | 1535   | 1615     | 1695      |
| 175 DOUBLE CHAIR LEFT ARM              | 39x40x33/40   | 1590    | 1680                  | 1770   | 1860   | 1950                             | 2040                      | 1285   | 1350     | 1415      |
| 176 DOUBLE CHAIR RIGHT ARM             | 39x40x33/40   | 1590    | 1680                  | 1770   | 1860   | 1950                             | 2040                      | 1285   | 1350     | 1415      |
| 177 ARMLESS DOUBLE CHAIR               | 30,5x40x33/40 | 1185    | 1250                  | 1315   | 1380   | 1445                             | 1510                      | 915    | 970      | 1025      |
| 178 ARMLESS DOUBLE CHAIR BUMPER LEFT   | 52x40x33/40   | 1545    | 1625                  | 1705   | 1785   | 1865                             | 1945                      | 1230   | 1290     | 1350      |
| 179 ARMLESS DOUBLE CHAIR BUMPER RIGHT  | 52x40x33/40   | 1545    | 1625                  | 1705   | 1785   | 1865                             | 1945                      | 1230   | 1290     | 1350      |
| 186 ARMLESS LOVESEAT BUMPER STORAGE-L  | 68x40x33/40   | 2420    | 2500                  | 2580   | 2660   | 2740                             | 2820                      | 1950   | 2015     | 2080      |
| 187 ARMLESS LOVESEAT BUMPER STORAGE-R  | 68x40x33/40   | 2420    | 2500                  | 2580   | 2660   | 2740                             | 2820                      | 1950   | 2015     | 2080      |
| 188 ARMLESS CHAIR BUMPER STORAGE-L     | 45x40x33/40   | 1600    | 1690                  | 1780   | 1870   | 1960                             | 2050                      | 1295   | 1330     | 1365      |
| 189 ARMLESS CHAIR BUMPER STORAGE-R     | 45x40x33/40   | 1600    | 1690                  | 1780   | 1870   | 1960                             | 2050                      | 1295   | 1330     | 1365      |
| 221 ARMLESS DBL CHAIR BUMPER STORAGE-L | 52x40x33/40   | 1705    | 1790                  | 1875   | 1960   | 2045                             | 2130                      | 1390   | 1450     | 1510      |
| 222 ARMLESS DBL CHAIR BUMPER STORAGE-R | 52x40x33/40   | 1705    | 1790                  | 1875   | 1960   | 2045                             | 2130                      | 1390   | 1450     | 1510      |
| 223 APT SOFA NO ARM BUMPER STORAGE-L   | 82x40x33/40   | 2655    | 2785                  | 2915   | 3045   | 3175                             | 3305                      | 2120   | 2215     | 2310      |
| 224 APT SOFA NO ARM BUMPER STORAGE-R   | 82x40x33/40   | 2655    | 2785                  | 2915   | 3045   | 3175                             | 3305                      | 2120   | 2215     | 2310      |
| 236 RECLINING LOUNGE CHAIR LEFT ARM    | 32x62x33/40   | 2160    | 2225                  | 2290   | 2355   | 2420                             | 2485                      | 1820   | 1880     | 1940      |
| 237 RECLINING LOUNGE CHAIR RIGHT ARM   | 32x62x33/40   | 2160    | 2225                  | 2290   | 2355   | 2420                             | 2485                      | 1820   | 1880     | 1940      |
| 238 RECLINING DBL LOUNGE CHAIR L-ARM   | 39x62x33/40   | 2315    | 2405                  | 2495   | 2585   | 2675                             | 2765                      | 1940   | 2020     | 2100      |
| 239 RECLINING DBL LOUNGE CHAIR R-ARM   | 39x62x33/40   | 2315    | 2405                  | 2495   | 2585   | 2675                             | 2765                      | 1940   | 2020     | 2100      |
| <b>CONFIGURATIONS</b>                  |               |         |                       |  |  |                                  |                           |        |          |           |



## CDN Price List

### LYON

| Description                | L x D x H  | Leather |                       |  |  |                                  |                           | Fabric |          |           |
|----------------------------|------------|---------|-----------------------|--|--|----------------------------------|---------------------------|--------|----------|-----------|
|                            |            | 10      | 20<br>Madras<br>Softy | 30<br>Hugo<br>Fantasy<br>Illusion<br>Tucson<br>Utah<br>Vintage<br>Wild Laredo<br>Yukon | 40<br>Elegance<br>Princess<br>Santiago<br>Sensation<br>Sunset<br>Trina<br>Victoria | 50<br>Bull<br>Cassiope<br>Dublin | 60<br>Caress<br>Ultrasued | A      | B<br>COM | C<br>alta |
| A CONFIG (169-170)         | 78X40X40   | 3980    | 4140                  | 4300   | 4460   | 4620                             | 4780                      | 3340   | 3500     | 3660      |
| B CONFIG (169-171-174)     | 109X62X40  | 5480    | 5700                  | 5920   | 6140   | 6360                             | 6580                      | 4525   | 4745     | 4965      |
| C CONFIG (096-055-171-170) | 114X114X40 | 8050    | 8385                  | 8720   | 9055   | 9390                             | 9725                      | 6520   | 6805     | 7090      |
| D CONFIG (169-171-055-179) | 114X96X40  | 7025    | 7330                  | 7635   | 7940   | 8245                             | 8550                      | 5730   | 5985     | 6240      |
| J CONFIG (041-042)         | 64X40X40   | 3770    | 3920                  | 4070   | 4220   | 4370                             | 4520                      | 3210   | 3280     | 3350      |
| K CONFIG (041-071-005)     | 88X62X40   | 5120    | 5315                  | 5510   | 5705   | 5900                             | 6095                      | 4265   | 4420     | 4575      |
| L CONFIG (012-055-071-042) | 100X100X40 | 7590    | 7915                  | 8240   | 8565   | 8890                             | 9215                      | 6215   | 6440     | 6665      |
| M CONFIG (041-071-055-089) | 100X89X40  | 6710    | 7030                  | 7350   | 7670   | 7990                             | 8310                      | 5495   | 5680     | 5865      |



# LYON

**OPTIMA**  
Collection

**Jaymar**

Conçu et fabriqué fièrement au Canada  
Proudly designed and made in Canada

Nos produits sont fabriqués à la main et des variations mineures peuvent survenir.

Our product is hand-made and minor variations can occur.

## SPECIFICATIONS

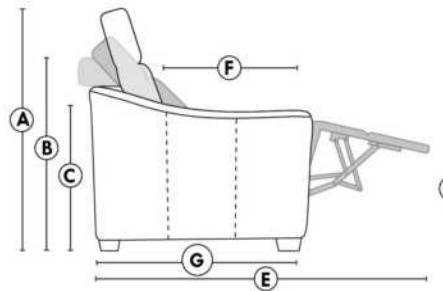

- Appui-tête levé Headrest up
- Appui-tête baissé Headrest down
- Complètement incliné Fully reclined

- A** Hauteur complète 40" Total Height
- B** Hauteur appui-tête baissé 33" Height headrest down
- C** Hauteur du bras 23" Arm Height
- D** Hauteur du siège 19,5" Seat height
- E** Profondeur inclinée 65" Depth fully reclined
- F** Profondeur d'assise 20"ou/ou 22" Seat depth
- G** Profondeur appui-tête monté 37,5" Depth with headrest up

## BRAS | ARMS

Option de bras:  
Bras Régulier Large 8" ou Petit bras 6"

Arm option  
Regular arm Large 8" or Small arm 6"

Contrôle de l'inclinaison situé à l'extérieur du bras  
Recliner control located on the outside of the arm.

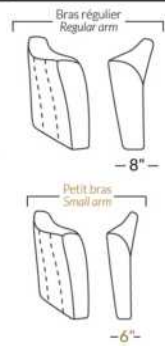

## FAUTEUIL BERÇANT PIVOTANT INCLINABLE SWIVEL ROCKING MOTION CHAIR

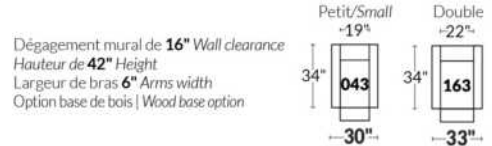

## SIÈGE 23" DE LARGE | 23" SEAT WIDTH

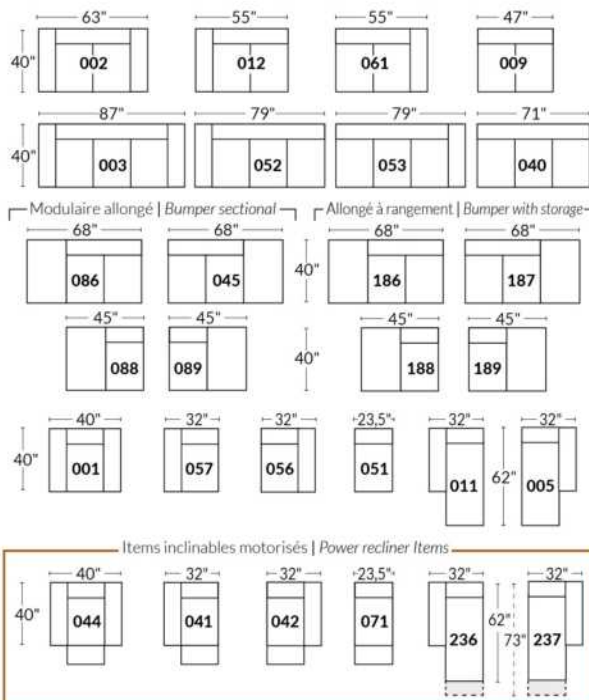

## SIÈGE 30" DE LARGE | 30" SEAT WIDTH

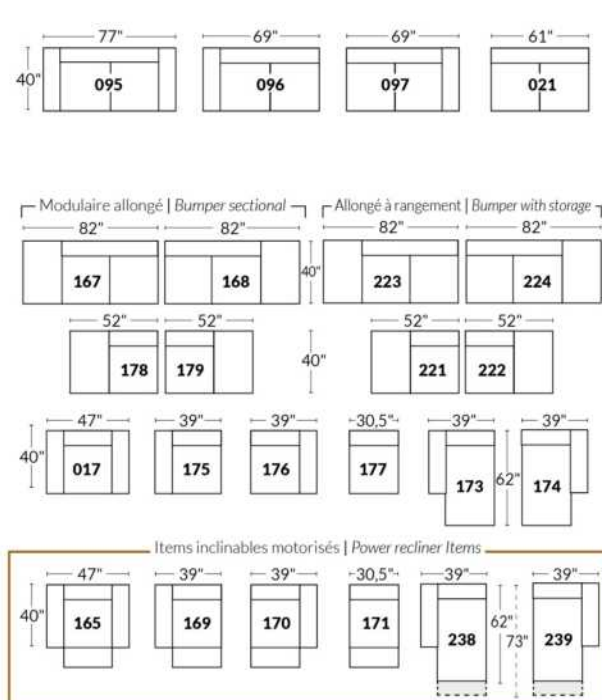

### Autres | Others

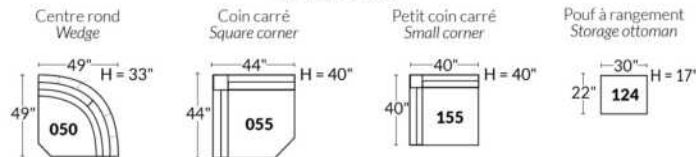

### EXEMPLE 23" EXAMPLE

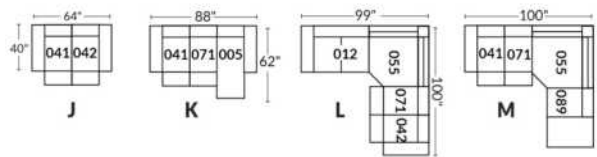

### EXEMPLE 30" EXAMPLE

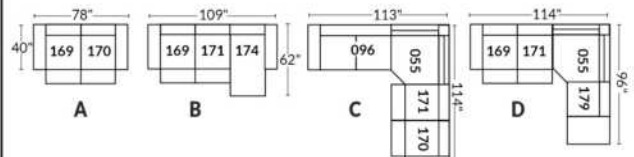

## MAGGY

FEATURES: Upholstered seat cushions with high quality 2.5 lb. density shaped foam and a 1" layer of memory foam.

LEG: Specify colour of legs LG187.  
Sku 077: Specify colour of table top in wood.

In FABRIC, the stitching will be with a thinner thread.  
IN LEATHER available with CONTRASTING THREAD: Upcharge of \$50/piece. Specify thread number: 005 Black, 087 Beige, 103 Brown, 111 White.

COMBO:  
Cover #1: Arm (EXCEPT outside), front rail (EXCEPT lower roll), Outside back.  
Cover #2: Outside shell of arm, lower roll of front rail, seat & back cushions.

| Description                         | L x D x H      | Leather |                       |  |  |                                  |                           | Fabric |          |           |
|-------------------------------------|----------------|---------|-----------------------|--|--|----------------------------------|---------------------------|--------|----------|-----------|
|                                     |                | 10      | 20<br>Madras<br>Softy | 30<br>Hugo<br>Fantasy<br>Illusion<br>Tucson<br>Utah<br>Vintage<br>Wild Laredo<br>Yukon | 40<br>Elegance<br>Princess<br>Santiago<br>Sensation<br>Sunset<br>Trina<br>Victoria | 50<br>Bull<br>Cassiope<br>Dublin | 60<br>Caress<br>Ultrasued | A      | B<br>COM | C<br>alta |
| 001 CHAIR                           | 44X42X30/39    | 1980    | 2075                  | 2170   | 2265   | 2360                             | 2455                      | 1385   | 1445     | 1505      |
| 002 LOVESEAT                        | 67X42X30/39    | 2795    | 2930                  | 3065   | 3200   | 3335                             | 3470                      | 1960   | 2045     | 2130      |
| 006 OTTOMAN                         | 25.5X25.5X17.5 | 700     | 725                   | 750  | 775  | 800                              | 825                       | 535    | 550      | 565       |
| 012 LOVESEAT LEFT ARM               | 56.5X42X30/39  | 2420    | 2565                  | 2710   | 2855   | 3000                             | 3145                      | 1855   | 1945     | 2035      |
| 024 SECTIONAL LOVESEAT BUMPER RIGHT | 85X42X30/39    | 3245    | 3400                  | 3555   | 3710   | 3865                             | 4020                      | 2420   | 2515     | 2610      |
| 045 ARMLESS LOVESEAT BUMPER RIGHT   | 66X42X30/39    | 2420    | 2565                  | 2710   | 2855   | 3000                             | 3145                      | 1855   | 1945     | 2035      |
| 048 SECTIONAL LOVESEAT BUMPER LEFT  | 85X42X30/39    | 3245    | 3400                  | 3555   | 3710   | 3865                             | 4020                      | 2420   | 2515     | 2610      |
| 051 ARMLESS CHAIR                   | 30.5X42X30/39  | 1400    | 1505                  | 1610   | 1715   | 1820                             | 1925                      | 1230   | 1295     | 1360      |
| 055 SQUARE CORNER                   | 42X42X30/39    | 1985    | 2080                  | 2175   | 2270   | 2365                             | 2460                      | 1450   | 1545     | 1640      |
| 056 CHAIR RIGHT ARM                 | 33.5X42X30/39  | 1630    | 1715                  | 1800   | 1885   | 1970                             | 2055                      | 1280   | 1350     | 1420      |
| 057 CHAIR LEFT ARM                  | 33.5X42X30/39  | 1630    | 1715                  | 1800   | 1885   | 1970                             | 2055                      | 1280   | 1350     | 1420      |
| 061 LOVESEAT RIGHT ARM              | 56.5X42X30/39  | 2420    | 2565                  | 2710   | 2855   | 3000                             | 3145                      | 1855   | 1945     | 2035      |
| 077 UPHOLSTERED TABLE               | 42X42X17.5     | 875     | 905                   | 935  | 965  | 995                              | 1025                      | 715    | 730      | 745       |
| 086 ARMLESS LOVESEAT BUMPER LEFT    | 66X42X30/39    | 2420    | 2565                  | 2710   | 2855   | 3000                             | 3145                      | 1855   | 1945     | 2035      |
| 088 ARMLESS CHAIR BUMPER LEFT       | 43X42X30/39    | 1630    | 1715                  | 1800   | 1885   | 1970                             | 2055                      | 1280   | 1350     | 1420      |
| 089 ARMLESS CHAIR BUMPER RIGHT      | 43X42X30/39    | 1630    | 1715                  | 1800   | 1885   | 1970                             | 2055                      | 1280   | 1350     | 1420      |
| 095 APARTMENT SOFA                  | 82X42X30/39    | 3095    | 3250                  | 3405   | 3560   | 3715                             | 3870                      | 2110   | 2200     | 2290      |
| 096 APARTMENT SOFA LEFT ARM         | 71.5X42X30/39  | 2725    | 2895                  | 3065   | 3235   | 3405                             | 3575                      | 2000   | 2100     | 2200      |
| 097 APARTMENT SOFA RIGHT ARM        | 71.5X42X30/39  | 2725    | 2895                  | 3065   | 3235   | 3405                             | 3575                      | 2000   | 2100     | 2200      |
| <b>CONFIGURATIONS</b>               |                |         |                       |  |  |                                  |                           |        |          |           |
| A CONF. A (57-55-61)                | 75.5X98.5X42   | 6035    | 6360                  | 6685   | 7010   | 7335                             | 7660                      | 4585   | 4840     | 5095      |
| B CONF. B (95-55-89)                | 113.5X85X42    | 6340    | 6690                  | 7040   | 7390   | 7740                             | 8090                      | 4730   | 4995     | 5260      |
| C CONF. C (88-77-97)                | 85X113.5X42    | 5230    | 5515                  | 5800   | 6085   | 6370                             | 6655                      | 3995   | 4180     | 4365      |

## CDN Price List

### MAGGY

| Description             | L x D x H    | Leather |                       |  |  |                                  |                           | Fabric |          |           |
|-------------------------|--------------|---------|-----------------------|--|--|----------------------------------|---------------------------|--------|----------|-----------|
|                         |              | 10      | 20<br>Madras<br>Softy | 30<br>Hugo<br>Fantasy<br>Illusion<br>Tucson<br>Utah<br>Vintage<br>Wild Laredo<br>Yukon | 40<br>Elegance<br>Princess<br>Santiago<br>Sensation<br>Sunset<br>Trina<br>Victoria | 50<br>Bull<br>Cassiope<br>Dublin | 60<br>Caress<br>Ultrasued | A      | B<br>COM | C<br>alta |
| D CONF. D (12-77-61)    | 98.5X98.5X42 | 5715    | 6035                  | 6355   | 6675   | 6995                             | 7315                      | 4425   | 4620     | 4815      |
| E CONF. E (96-51-55-61) | 144X98.5X42  | 8530    | 9045                  | 9560   | 10075  | 10590                            | 11105                     | 6535   | 6885     | 7235      |
| F CONF. F (86-55-97)    | 108X113.5X42 | 7130    | 7540                  | 7950   | 8360   | 8770                             | 9180                      | 5305   | 5590     | 5875      |

# MAGGY



Hauteur complète 30"/39" | Hauteur de siège 19" | Hauteur devant bras 24" | Profondeur d'assise 22"  
 Total Height 30"/39" | Seat Height 19" | Arm Height 24" | Seat Depth 22"

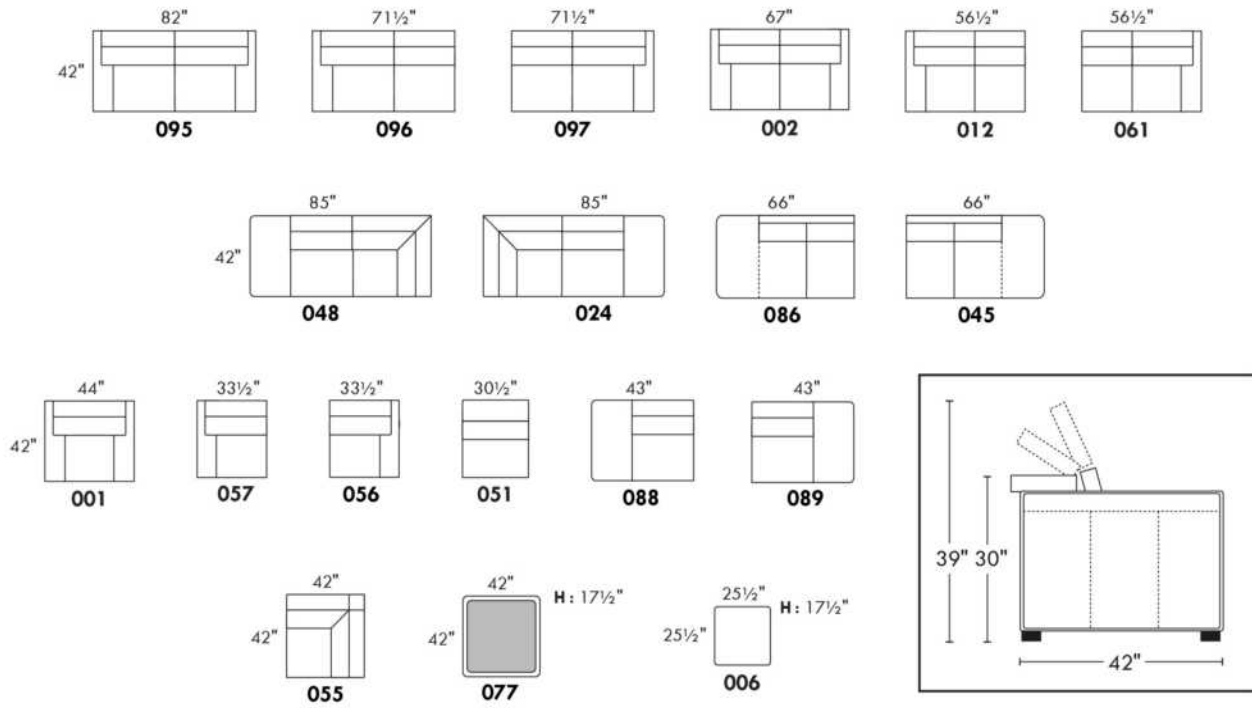

## CONFIGURATIONS

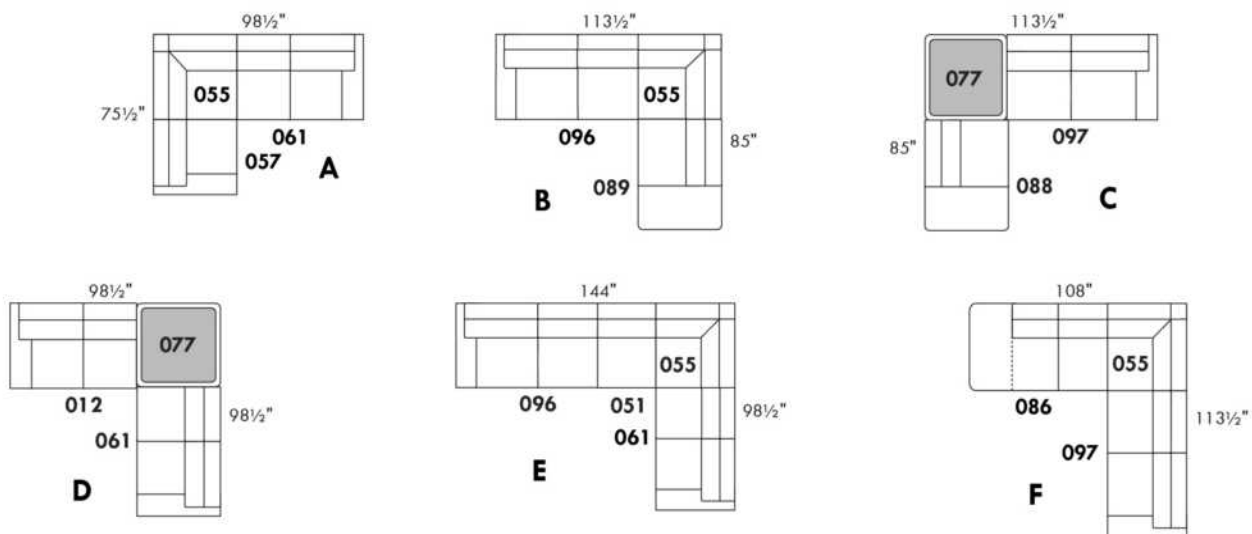

www.jaymar.ca

Toutes les dimensions indiquées sont au pouce près. Nos produits sont fabriqués à la main et des variations mineures peuvent survenir.  
 All dimensions indicated are to the nearest inch. Our product is hand-made and minor variations can occur.

## MALAGA

**FEATURES:**

- Manual adjustable headrest on all items (2 on square corner & stationary on wedge).
- \*Wall hugger power recliners with full footrest (manual n/a).
- Power recliner lounge chair (manual n/a) with power headrest in option. Wall clearance 8" & front 5".
- Seat cushions with shaped foam + 1" layer of memory foam on top; arm with memory foam.
- Stitching: Small thread in fabric & large flat thread in leather.
- \*Excludes Chairs 043 & 163: Wall clearance 16"

Note: 2 recliner seats separated by a corner can not be opened at the same time. No recliner seats beside #155 Small Square Corner.

**OPTIONS**

- Battery Pack: Add \$160/ea.
- \*Motorized headrest: Add \$160 ea. (\*N/A on stationary items).
- Foam: Extra firm add \$15/seat.
- Choice of Large or Small 6" Arm: Leg on LARGE arm: LG103 wood or LG189 metal (Black or Chrome). SMALL Arm: LG08 wood or LG196 metal (Black or Chrome). Specify colour.
- Seat Depth: 20" or \*22". \*22" seat depth N/A on chairs 043 & 163.
- 043 & 163 Chairs: with wood base (specify colour).

**HOME THEATRE Configurations**

For Accessories, Cup holders & Configuration details, see Optima Home Theatre page attached.

Accessory Dock: \$35 ea.

Cup Holders: Metal: \$25 ea. | LED lighted Cup Holder: \$25 ea. | \*LED lighted Cup Holder with (1 or 2 motor) controls: \$40 ea.

\*LED Light strip under seat: \$25/seat.

| Description                        | L x D x H   | Leather |                       |  |  |                                  |                           | Fabric |          |           |
|------------------------------------|-------------|---------|-----------------------|--|--|----------------------------------|---------------------------|--------|----------|-----------|
|                                    |             | 10      | 20<br>Madras<br>Softy | 30<br>Hugo<br>Fantasy<br>Illusion<br>Tucson<br>Utah<br>Vintage<br>Wild Laredo<br>Yukon | 40<br>Elegance<br>Princess<br>Santiago<br>Sensation<br>Sunset<br>Trina<br>Victoria | 50<br>Bull<br>Cassiope<br>Dublin | 60<br>Caress<br>Ultrasued | A      | B<br>COM | C<br>alta |
| 001 CHAIR                          | 44x40x33/40 | 1890    | 1980                  | 2070   | 2160   | 2250                             | 2340                      | 1535   | 1580     | 1625      |
| 002 LOVESEAT                       | 67x40x33/40 | 2700    | 2815                  | 2930   | 3045   | 3160                             | 3275                      | 2175   | 2250     | 2325      |
| 003 SOFA                           | 91x40x33/40 | 3265    | 3415                  | 3565   | 3715   | 3865                             | 4015                      | 2625   | 2715     | 2805      |
| 005 LOUNGE CHAIR RIGHT ARM         | 34x62x33/40 | 1765    | 1830                  | 1895   | 1960   | 2025                             | 2090                      | 1410   | 1470     | 1530      |
| 009 ARMLESS LOVESEAT               | 47x40x33/40 | 1895    | 1965                  | 2035   | 2105   | 2175                             | 2245                      | 1490   | 1570     | 1650      |
| 011 LOUNGE CHAIR LEFT ARM          | 34x62x33/40 | 1765    | 1830                  | 1895   | 1960   | 2025                             | 2090                      | 1410   | 1470     | 1530      |
| 012 LOVESEAT LEFT ARM              | 57x40x33/40 | 2320    | 2420                  | 2520   | 2620   | 2720                             | 2820                      | 1850   | 1925     | 2000      |
| 017 DOUBLE CHAIR                   | 51x40x33/40 | 1980    | 2080                  | 2180   | 2280   | 2380                             | 2480                      | 1600   | 1660     | 1720      |
| 021 APARTMENT SOFA NO ARM          | 61x40x33/40 | 2140    | 2240                  | 2340   | 2440   | 2540                             | 2640                      | 1670   | 1755     | 1840      |
| 040 ARMLESS SOFA                   | 71x40x33/40 | 2450    | 2565                  | 2680   | 2795   | 2910                             | 3025                      | 1950   | 2040     | 2130      |
| 041 RECLINING CHAIR LEFT ARM       | 34x40x33/40 | 1885    | 1960                  | 2035   | 2110   | 2185                             | 2260                      | 1605   | 1640     | 1675      |
| 042 RECLINING CHAIR RIGHT ARM      | 34x40x33/40 | 1885    | 1960                  | 2035   | 2110   | 2185                             | 2260                      | 1605   | 1640     | 1675      |
| 043 SWIVEL ROCKING RECLINING CHAIR | 30x34x42    | 2235    | 2345                  | 2455   | 2565   | 2675                             | 2785                      | 1875   | 1920     | 1965      |
| 044 RECLINER CHAIR                 | 44x40x33/40 | 2275    | 2365                  | 2455   | 2545   | 2635                             | 2725                      | 1920   | 1970     | 2020      |
| 045 ARMLESS LOVESEAT BUMPER RIGHT  | 68x40x33/40 | 2245    | 2340                  | 2435   | 2530   | 2625                             | 2720                      | 1785   | 1850     | 1915      |
| 050 WEDGE                          | 49x49x33    | 1645    | 1745                  | 1845   | 1945   | 2045                             | 2145                      | 1210   | 1270     | 1330      |

## MALAGA

### FEATURES:

- Manual adjustable headrest on all items (2 on square corner & stationary on wedge).
- \*Wall hugger power recliners with full footrest (manual n/a).
- Power recliner lounge chair (manual n/a) with power headrest in option. Wall clearance 8" & front 5".
- Seat cushions with shaped foam + 1" layer of memory foam on top; arm with memory foam.
- Stitching: Small thread in fabric & large flat thread in leather.
- \*Excludes Chairs 043 & 163: Wall clearance 16"

Note: 2 recliner seats separated by a corner can not be opened at the same time. No recliner seats beside #155 Small Square Corner.

### OPTIONS

- Battery Pack: Add \$160/ea.
- \*Motorized headrest: Add \$160 ea. (\*N/A on stationary items).
- Foam: Extra firm add \$15/seat.
- Choice of Large or Small 6" Arm: Leg on LARGE arm: LG103 wood or LG189 metal (Black or Chrome). SMALL Arm: LG08 wood or LG196 metal (Black or Chrome). Specify colour.
- Seat Depth: 20" or \*22". \*22" seat depth N/A on chairs 043 & 163.
- 043 & 163 Chairs: with wood base (specify colour).

### HOME THEATRE Configurations

For Accessories, Cup holders & Configuration details, see Optima Home Theatre page attached.

Accessory Dock: \$35 ea.

Cup Holders: Metal: \$25 ea. | LED lighted Cup Holder: \$25 ea. | \*LED lighted Cup Holder with (1 or 2 motor) controls: \$40 ea.

\*LED Light strip under seat: \$25/seat.

| Description                      | L x D x H     | Leather |                       |  |  |                                  |                            | Fabric |          |           |
|----------------------------------|---------------|---------|-----------------------|--|--|----------------------------------|----------------------------|--------|----------|-----------|
|                                  |               | 10      | 20<br>Madras<br>Softy | 30<br>Hugo<br>Fantasy<br>Illusion<br>Tucson<br>Utah<br>Vintage<br>Wild Laredo<br>Yukon | 40<br>Elegance<br>Princess<br>Santiago<br>Sensation<br>Sunset<br>Trina<br>Victoria | 50<br>Bull<br>Cassiope<br>Dublin | 60<br>Caresse<br>Ultrasued | A      | B<br>COM | C<br>alta |
| 051 ARMLESS CHAIR                | 23,5x40x33/40 | 1085    | 1135                  | 1185   | 1235   | 1285                             | 1335                       | 845    | 900      | 955       |
| 052 SOFA LEFT ARM                | 81x40x33/40   | 2870    | 3005                  | 3140   | 3275   | 3410                             | 3545                       | 2290   | 2385     | 2480      |
| 053 SOFA RIGHT ARM               | 81x40x33/40   | 2870    | 3005                  | 3140   | 3275   | 3410                             | 3545                       | 2290   | 2385     | 2480      |
| 055 SQUARE CORNER                | 44x44x33/40   | 1915    | 2010                  | 2105   | 2200   | 2295                             | 2390                       | 1510   | 1565     | 1620      |
| 056 CHAIR RIGHT ARM              | 34x40x33/40   | 1510    | 1575                  | 1640   | 1705   | 1770                             | 1835                       | 1200   | 1260     | 1320      |
| 057 CHAIR LEFT ARM               | 34x40x33/40   | 1510    | 1575                  | 1640   | 1705   | 1770                             | 1835                       | 1200   | 1260     | 1320      |
| 061 LOVESEAT RIGHT ARM           | 57x40x33/40   | 2320    | 2420                  | 2520   | 2620   | 2720                             | 2820                       | 1850   | 1925     | 2000      |
| 071 ARMLESS RECLINING CHAIR      | 23,5x40x33/40 | 1470    | 1525                  | 1580   | 1635   | 1690                             | 1745                       | 1250   | 1310     | 1370      |
| 086 ARMLESS LOVESEAT BUMPER LEFT | 68x40x33/40   | 2245    | 2340                  | 2435   | 2530   | 2625                             | 2720                       | 1785   | 1850     | 1915      |
| 088 ARMLESS CHAIR BUMPER LEFT    | 45x40x33/40   | 1440    | 1535                  | 1630   | 1725   | 1820                             | 1915                       | 1130   | 1165     | 1200      |
| 089 ARMLESS CHAIR BUMPER RIGHT   | 45x40x33/40   | 1440    | 1535                  | 1630   | 1725   | 1820                             | 1915                       | 1130   | 1165     | 1200      |
| 095 APARTMENT SOFA               | 81x40x33/40   | 2940    | 3085                  | 3230   | 3375   | 3520                             | 3665                       | 2350   | 2445     | 2540      |
| 096 APARTMENT SOFA LEFT ARM      | 71x40x33/40   | 2570    | 2680                  | 2790   | 2900   | 3010                             | 3120                       | 2020   | 2110     | 2200      |
| 097 APARTMENT SOFA RIGHT ARM     | 71x40x33/40   | 2570    | 2680                  | 2790   | 2900   | 3010                             | 3120                       | 2020   | 2110     | 2200      |
| 124 STORAGE OTTOMAN              | 30x22x17      | 745     | 765                   | 785  | 805  | 825                              | 845                        | 650    | 670      | 690       |
| 138 STRAIGHT ARM                 | 10x36x24.5    | 415     | 450                   | 485  | 520  | 555                              | 590                        | 350    | 365      | 380       |

## MALAGA

**FEATURES:**

- Manual adjustable headrest on all items (2 on square corner & stationary on wedge).
- \*Wall hugger power recliners with full footrest (manual n/a).
- Power recliner lounge chair (manual n/a) with power headrest in option. Wall clearance 8" & front 5".
- Seat cushions with shaped foam + 1" layer of memory foam on top; arm with memory foam.
- Stitching: Small thread in fabric & large flat thread in leather.
- \*Excludes Chairs 043 & 163: Wall clearance 16"

Note: 2 recliner seats separated by a corner can not be opened at the same time. No recliner seats beside #155 Small Square Corner.

**OPTIONS**

- Battery Pack: Add \$160/ea.
- \*Motorized headrest: Add \$160 ea. (\*N/A on stationary items).
- Foam: Extra firm add \$15/seat.
- Choice of Large or Small 6" Arm: Leg on LARGE arm: LG103 wood or LG189 metal (Black or Chrome). SMALL Arm: LG08 wood or LG196 metal (Black or Chrome). Specify colour.
- Seat Depth: 20" or \*22". \*22" seat depth N/A on chairs 043 & 163.
- 043 & 163 Chairs: with wood base (specify colour).

**HOME THEATRE Configurations**

For Accessories, Cup holders & Configuration details, see Optima Home Theatre page attached.

Accessory Dock: \$35 ea.

Cup Holders: Metal: \$25 ea. | LED lighted Cup Holder: \$25 ea. | \*LED lighted Cup Holder with (1 or 2 motor) controls: \$40 ea.

\*LED Light strip under seat: \$25/seat.

| Description                            | L x D x H     | Leather |                       |  |  |                                  |                           | Fabric |          |           |
|--|---------------|---------|-----------------------|--|--|----------------------------------|---------------------------|--------|----------|-----------|
|  |               | 10      | 20<br>Madras<br>Softy | 30<br>Hugo<br>Fantasy<br>Illusion<br>Tucson<br>Utah<br>Vintage<br>Wild Laredo<br>Yukon | 40<br>Elegance<br>Princess<br>Santiago<br>Sensation<br>Sunset<br>Trina<br>Victoria | 50<br>Bull<br>Cassiope<br>Dublin | 60<br>Caress<br>Ultrasued | A      | B<br>COM | C<br>alta |
| 155 SMALL SQUARE CORNER                | 40x40x33/40   | 1915    | 2010                  | 2105   | 2200   | 2295                             | 2390                      | 1510   | 1565     | 1620      |
| 159 WEDGE STORAGE                      | 11/27x36x24.5 | 745     | 775                   | 805  | 835  | 865                              | 895                       | 585    | 600      | 615       |
| 160 STRAIGHT STORAGE                   | 11x36x24.5    | 720     | 745                   | 770  | 795  | 820                              | 845                       | 550    | 570      | 590       |
| 163 DBL SWIVEL ROCKING RECLINER CHAIR  | 33x34x42      | 2290    | 2410                  | 2530   | 2650   | 2770                             | 2890                      | 1880   | 1930     | 1980      |
| 165 DOUBLE RECLINING CHAIR             | 51x40x33/40   | 2375    | 2475                  | 2575   | 2675   | 2775                             | 2875                      | 2000   | 2065     | 2130      |
| 167 APARTMENT SOFA NO ARM BUMPER LEFT  | 82x40x33/40   | 2490    | 2620                  | 2750   | 2880   | 3010                             | 3140                      | 1960   | 2045     | 2130      |
| 168 APARTMENT SOFA NO ARM BUMPER RIGHT | 82x40x33/40   | 2490    | 2620                  | 2750   | 2880   | 3010                             | 3140                      | 1960   | 2045     | 2130      |
| 169 DOUBLE RECLINING CHAIR LEFT ARM    | 41x40x33/40   | 1990    | 2070                  | 2150   | 2230   | 2310                             | 2390                      | 1670   | 1750     | 1830      |
| 170 DOUBLE RECLINING CHAIR RIGHT ARM   | 41x40x33/40   | 1990    | 2070                  | 2150   | 2230   | 2310                             | 2390                      | 1670   | 1750     | 1830      |
| 171 ARMLESS DOUBLE RECLINING CHAIR     | 30,5x40x33/40 | 1575    | 1625                  | 1675   | 1725   | 1775                             | 1825                      | 1320   | 1380     | 1440      |
| 173 DOUBLE LOUNGE CHAIR LEFT ARM       | 41x62x33/40   | 1915    | 2005                  | 2095   | 2185   | 2275                             | 2365                      | 1535   | 1615     | 1695      |
| 174 DOUBLE LOUNGE CHAIR RIGHT ARM      | 41x62x33/40   | 1915    | 2005                  | 2095   | 2185   | 2275                             | 2365                      | 1535   | 1615     | 1695      |
| 175 DOUBLE CHAIR LEFT ARM              | 41x40x33/40   | 1590    | 1680                  | 1770   | 1860   | 1950                             | 2040                      | 1285   | 1350     | 1415      |
| 176 DOUBLE CHAIR RIGHT ARM             | 41x40x33/40   | 1590    | 1680                  | 1770   | 1860   | 1950                             | 2040                      | 1285   | 1350     | 1415      |
| 177 ARMLESS DOUBLE CHAIR               | 30,5x40x33/40 | 1185    | 1250                  | 1315   | 1380   | 1445                             | 1510                      | 915    | 970      | 1025      |
| 178 ARMLESS DOUBLE CHAIR BUMPER LEFT   | 52x40x33/40   | 1545    | 1625                  | 1705   | 1785   | 1865                             | 1945                      | 1230   | 1290     | 1350      |



## MALAGA

### FEATURES:

- Manual adjustable headrest on all items (2 on square corner & stationary on wedge).
- \*Wall hugger power recliners with full footrest (manual n/a).
- Power recliner lounge chair (manual n/a) with power headrest in option. Wall clearance 8" & front 5".
- Seat cushions with shaped foam + 1" layer of memory foam on top; arm with memory foam.
- Stitching: Small thread in fabric & large flat thread in leather.
- \*Excludes Chairs 043 & 163: Wall clearance 16"

Note: 2 recliner seats separated by a corner can not be opened at the same time. No recliner seats beside #155 Small Square Corner.

### OPTIONS

- Battery Pack: Add \$160/ea.
- \*Motorized headrest: Add \$160 ea. (\*N/A on stationary items).
- Foam: Extra firm add \$15/seat.
- Choice of Large or Small 6" Arm: Leg on LARGE arm: LG103 wood or LG189 metal (Black or Chrome). SMALL Arm: LG08 wood or LG196 metal (Black or Chrome). Specify colour.
- Seat Depth: 20" or \*22". \*22" seat depth N/A on chairs 043 & 163.
- 043 & 163 Chairs: with wood base (specify colour).

### HOME THEATRE Configurations

For Accessories, Cup holders & Configuration details, see Optima Home Theatre page attached.

Accessory Dock: \$35 ea.

Cup Holders: Metal: \$25 ea. | LED lighted Cup Holder: \$25 ea. | \*LED lighted Cup Holder with (1 or 2 motor) controls: \$40 ea.

\*LED Light strip under seat: \$25/seat.

| Description                            | L x D x H       | Leather |                       |  |  |                                  |                           | Fabric |          |           |
|--|-----------------|---------|-----------------------|--|--|----------------------------------|---------------------------|--------|----------|-----------|
|  |                 | 10      | 20<br>Madras<br>Softy | 30<br>Hugo<br>Fantasy<br>Illusion<br>Tucson<br>Utah<br>Vintage<br>Wild Laredo<br>Yukon | 40<br>Elegance<br>Princess<br>Santiago<br>Sensation<br>Sunset<br>Trina<br>Victoria | 50<br>Bull<br>Cassiope<br>Dublin | 60<br>Caress<br>Ultrasued | A      | B<br>COM | C<br>alta |
| 179 ARMLESS DOUBLE CHAIR BUMPER RIGHT  | 52x40x33/40     | 1545    | 1625                  | 1705   | 1785   | 1865                             | 1945                      | 1230   | 1290     | 1350      |
| 186 ARMLESS LOVESEAT BUMPER STORAGE-L  | 68x40x33/40     | 2420    | 2500                  | 2580   | 2660   | 2740                             | 2820                      | 1950   | 2015     | 2080      |
| 187 ARMLESS LOVESEAT BUMPER STORAGE-R  | 68x40x33/40     | 2420    | 2500                  | 2580   | 2660   | 2740                             | 2820                      | 1950   | 2015     | 2080      |
| 188 ARMLESS CHAIR BUMPER STORAGE-L     | 45x40x33/40     | 1600    | 1690                  | 1780   | 1870   | 1960                             | 2050                      | 1295   | 1330     | 1365      |
| 189 ARMLESS CHAIR BUMPER STORAGE-R     | 45x40x33/40     | 1600    | 1690                  | 1780   | 1870   | 1960                             | 2050                      | 1295   | 1330     | 1365      |
| 190 SMALL WEDGE STORAGE                | 11/21x36x24.5   | 720     | 745                   | 770  | 795  | 820                              | 845                       | 550    | 570      | 590       |
| 221 ARMLESS DBL CHAIR BUMPER STORAGE-L | 52x40x33/40     | 1705    | 1790                  | 1875   | 1960   | 2045                             | 2130                      | 1390   | 1450     | 1510      |
| 222 ARMLESS DBL CHAIR BUMPER STORAGE-R | 52x40x33/40     | 1705    | 1790                  | 1875   | 1960   | 2045                             | 2130                      | 1390   | 1450     | 1510      |
| 223 APT SOFA NO ARM BUMPER STORAGE-L   | 82x40x33/40     | 2655    | 2785                  | 2915   | 3045   | 3175                             | 3305                      | 2120   | 2215     | 2310      |
| 224 APT SOFA NO ARM BUMPER STORAGE-R   | 82x40x33/40     | 2655    | 2785                  | 2915   | 3045   | 3175                             | 3305                      | 2120   | 2215     | 2310      |
| 236 RECLINING LOUNGE CHAIR LEFT ARM    | 34x62x33/40     | 2160    | 2225                  | 2290   | 2355   | 2420                             | 2485                      | 1820   | 1880     | 1940      |
| 237 RECLINING LOUNGE CHAIR RIGHT ARM   | 34x62x33/40     | 2160    | 2225                  | 2290   | 2355   | 2420                             | 2485                      | 1820   | 1880     | 1940      |
| 238 RECLINING DBL LOUNGE CHAIR L-ARM   | 41x62x33/40     | 2315    | 2405                  | 2495   | 2585   | 2675                             | 2765                      | 1940   | 2020     | 2100      |
| 239 RECLINING DBL LOUNGE CHAIR R-ARM   | 41x62x33/40     | 2315    | 2405                  | 2495   | 2585   | 2675                             | 2765                      | 1940   | 2020     | 2100      |
| V51 WINE GLASS HOLDER                  | 3.5 x 5.5 x 6.5 | 35      | 35                    | 35   | 35   | 35                               | 35                        | 35     | 35       | 35        |
| V52 PLASTIC SWIVEL TRAY                | 13 3/8 x 9 5/8  | 35      | 35                    | 35   | 35   | 35                               | 35                        | 35     | 35       | 35        |

## MALAGA

**FEATURES:**

- Manual adjustable headrest on all items (2 on square corner & stationary on wedge).
- \*Wall hugger power recliners with full footrest (manual n/a).
- Power recliner lounge chair (manual n/a) with power headrest in option. Wall clearance 8" & front 5".
- Seat cushions with shaped foam + 1" layer of memory foam on top; arm with memory foam.
- Stitching: Small thread in fabric & large flat thread in leather.
- \*Excludes Chairs 043 & 163: Wall clearance 16"

Note: 2 recliner seats separated by a corner can not be opened at the same time. No recliner seats beside #155 Small Square Corner.

**OPTIONS**

- Battery Pack: Add \$160/ea.
- \*Motorized headrest: Add \$160 ea. (\*N/A on stationary items).
- Foam: Extra firm add \$15/seat.
- Choice of Large or Small 6" Arm: Leg on LARGE arm: LG103 wood or LG189 metal (Black or Chrome). SMALL Arm: LG08 wood or LG196 metal (Black or Chrome). Specify colour.
- Seat Depth: 20" or \*22". \*22" seat depth N/A on chairs 043 & 163.
- 043 & 163 Chairs: with wood base (specify colour).

**HOME THEATRE Configurations**

For Accessories, Cup holders & Configuration details, see Optima Home Theatre page attached.

Accessory Dock: \$35 ea.

Cup Holders: Metal: \$25 ea. | LED lighted Cup Holder: \$25 ea. | \*LED lighted Cup Holder with (1 or 2 motor) controls: \$40 ea.

\*LED Light strip under seat: \$25/seat.

| Description                 | L x D x H          | Leather |                       |  |  |                                  |                           | Fabric |          |           |
|-----------------------------|--------------------|---------|-----------------------|--|--|----------------------------------|---------------------------|--------|----------|-----------|
|                             |                    | 10      | 20<br>Madras<br>Softy | 30<br>Hugo<br>Fantasy<br>Illusion<br>Tucson<br>Utah<br>Vintage<br>Wild Laredo<br>Yukon | 40<br>Elegance<br>Princess<br>Santiago<br>Sensation<br>Sunset<br>Trina<br>Victoria | 50<br>Bull<br>Cassiope<br>Dublin | 60<br>Caress<br>Ultrasued | A      | B<br>COM | C<br>alta |
| V53 WOOD SWIVEL TRAY        | 19 x 10            | 60      | 60                    | 60   | 60   | 60                               | 60                        | 60     | 60       | 60        |
| V54 TABLET HOLDER           | 4.5 x 8 x 10       | 40      | 40                    | 40   | 40   | 40                               | 40                        | 40     | 40       | 40        |
| V55 LED LAMP                | 1.5x5x14 pli /bent | 35      | 35                    | 35   | 35   | 35                               | 35                        | 35     | 35       | 35        |
| <b>CONFIGURATIONS</b>       |                    |         |                       |  |  |                                  |                           |        |          |           |
| _A CONFIG (169-170)         | 82X40X40           | 3980    | 4140                  | 4300   | 4460   | 4620                             | 4780                      | 3340   | 3500     | 3660      |
| _B CONFIG (169-171-174)     | 113X62X40          | 5480    | 5700                  | 5920   | 6140   | 6360                             | 6580                      | 4525   | 4745     | 4965      |
| _C CONFIG (096-055-171-170) | 115X115X40         | 8050    | 8385                  | 8720   | 9055   | 9390                             | 9725                      | 6520   | 6805     | 7090      |
| _D CONFIG (169-171-055-179) | 115X96X40          | 7025    | 7330                  | 7635   | 7940   | 8245                             | 8550                      | 5730   | 5985     | 6240      |
| _J CONFIG (041-042)         | 68X40X40           | 3770    | 3920                  | 4070   | 4220   | 4370                             | 4520                      | 3210   | 3280     | 3350      |
| _K CONFIG (041-071-005)     | 92X62X40           | 5120    | 5315                  | 5510   | 5705   | 5900                             | 6095                      | 4265   | 4420     | 4575      |
| _L CONFIG (012-055-071-042) | 102X102X40         | 7590    | 7915                  | 8240   | 8565   | 8890                             | 9215                      | 6215   | 6440     | 6665      |
| _M CONFIG (041-071-055-089) | 102X89X40          | 6710    | 7030                  | 7350   | 7670   | 7990                             | 8310                      | 5495   | 5680     | 5865      |



# MALAGA

**OPTIMA**  
Collection

**Jaymar**

Conçu et fabriqué fièrement au Canada  
Proudly designed and made in Canada

Nos produits sont fabriqués à la main et des variations mineures peuvent survenir

Our product is hand-made and minor variations can occur.

## SPECIFICATIONS

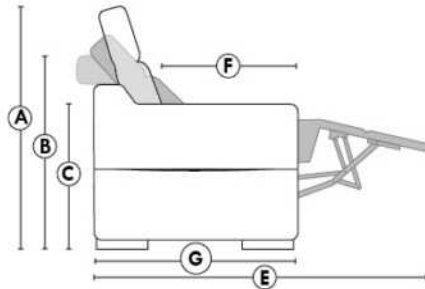

- Appui-tête levé Headrest up
- Appui-tête baissé Headrest down
- Complètement incliné Fully reclined

- A** Hauteur complète 40" Total Height
- B** Hauteur appui-tête baissé 33" Height headrest down
- C** Hauteur du bras 24,5" Arm Height
- D** Hauteur du siège 19,5" Seat height
- E** Profondeur inclinée 65" Depth fully reclined
- F** Profondeur d'assise 20"ou/ou 22" Seat depth
- G** Profondeur appui-tête monté 37,5" Depth with headrest up

## BRAS | ARMS

Option de bras:  
Bras Régulier Large 10" ou Petit bras 6"

Arm option  
Regular arm Large 10" or Small arm 6"

Contrôle de l'inclinaison situé à l'intérieur du bras  
Recliner control located on the inside of the arm.

Option d'accessoires disponible sur le bras régulier seulement  
Accessories option, available on Regular arms ONLY.

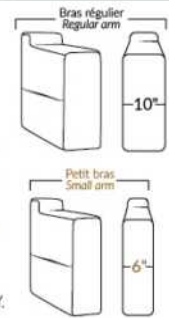

## FAUTEUIL BERÇANT PIVOTANT INCLINABLE SWIVEL ROCKING MOTION CHAIR

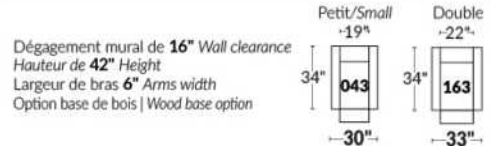

## SIÈGE 23" DE LARGE | 23" SEAT WIDTH

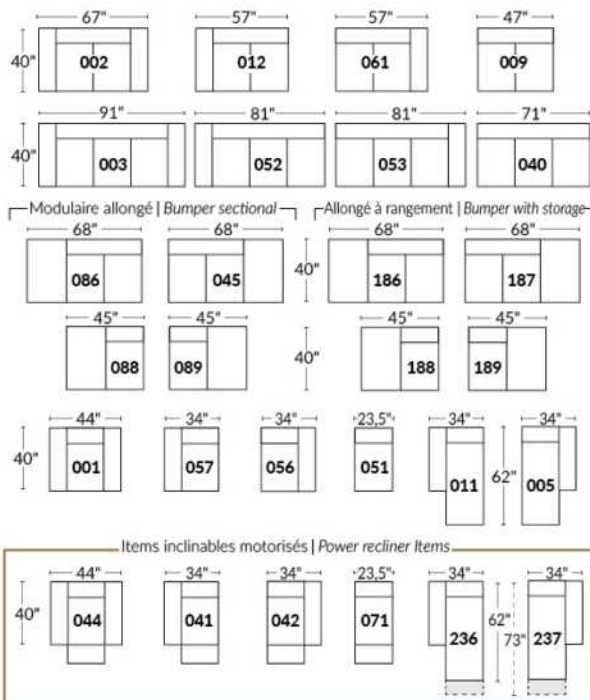

## SIÈGE 30" DE LARGE | 30" SEAT WIDTH

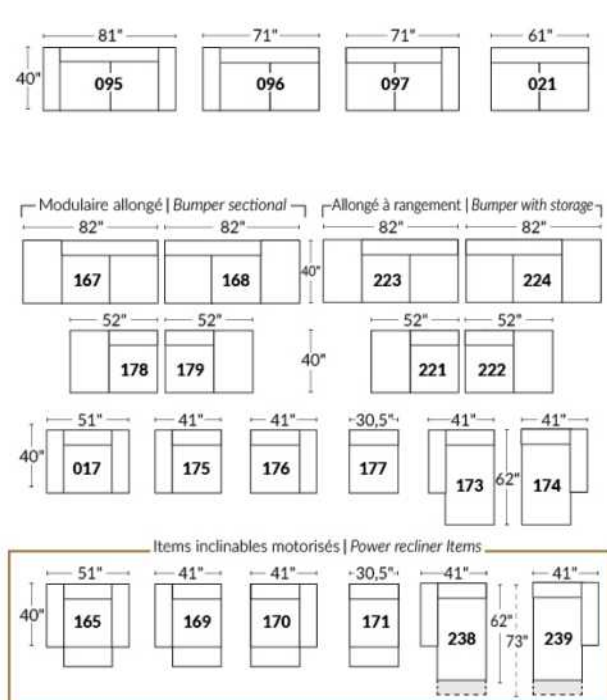

### Autres | Others

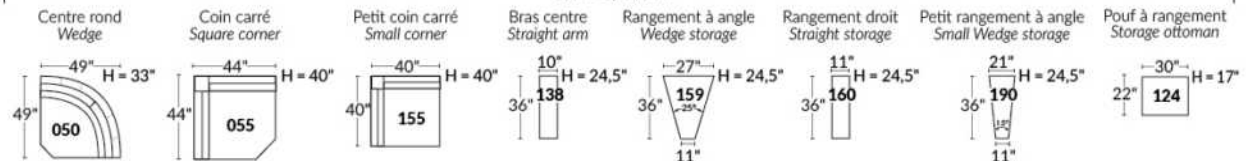

### EXEMPLE 23" EXAMPLE

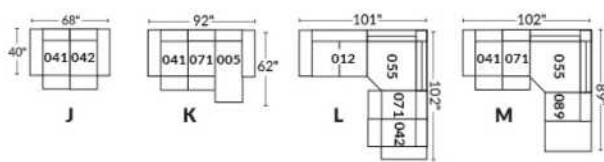

### EXEMPLE 30" EXAMPLE

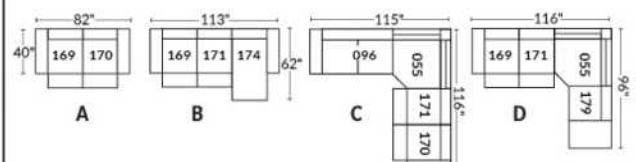

\*Available on certain models and on large arms ONLY.

### OPTIONS CUP HOLDERS

#### METAL



Silver



Matte Black



Brown

#### ILLUMINATED

1.



LED Lighted Cup holder

2.



LED Lighted Cup holder with Single Motor Control, USB Port and LED Base rail

3.



LED Lighted Cup holder with Dual Motor Control, USB Port and LED Base rail

Our illuminated one or two-control cup holders are compatible with LED lights under the seat. You can control the light on the cup holder. The 2 motor cup holder has a reset (home) button control to close your recliner back to its starting position.

#### LED Light under seat (Optional)

Available only in configurations with a minimum of 1 illuminated motorized cup holder with control buttons. The "light" button will control the opening and closing of the light.

For cup holder prices see description section of the Optima model price list.

Please provide us with a drawing of your configuration which indicates the cup holder type and its positioning.

#### Cup holder with controller:

It is important to specify the placement of the cups; on left arm or right arm and which recliner they will control. If you have a row of several seats with cup holders, by default, the controls will be on the left arms and on the right arm for the last outer chair.

#### EXAMPLE A:

041-169: Controller and cup holder on the left arm

071-171: hidden touch sensor buttons on side of seat

042-170: Controller and cup holder on right arm



#### EXAMPLE B:

071-171: These two items can be connected to a smart cup holder which will control the recliner. You must then use one of these items: 138,159, 160 and 190



#### Informations about headrest, controller on reclining seat

#### WITH illuminated cup holder

If you have a **stationary item**, you will have cup holder N°1.

If you have a recliner chair with a **manual headrest**, you will have the cup holder N°2.

If you have a recliner chair with an **electric headrest**, you will have cup holder N°3.

#### Without cup holder and with a reclining seat

If you have a recliner with a **manual headrest** you will have the touch sensor button control on the side of the seat.

If you have a recliner with an **electric headrest** you will have a dual push button controller with USB port on the arm.

If you have an **armless recliner**, you will have the hidden touch sensor button control.



Hidden touch sensor



Dual push button

# OPTIMA

## HOME THEATRE Configurations

\*Available on certain models and on large arms ONLY.

OPTIONS

### ACCESSORIES

Accessory Dock



V51 Wine Glass Holder



V52 Plastic Swivel Tray Table



V53 Wood Swivel tray Table  
(Choice of 8 colors)



Specify on which arm (left or right) the tray table will be installed.

V54 Tablet Holder



V55 LED Lamp



(For Accessory Dock price, see description section of the Optima model price list and for Accessory item prices, see at very end of the price list)

#### Items 138-159-160-190 and large arm.

Accessory docks and cups are Optional. \*Not available on small arms\*

Please specify on which arms you want the accessory docks and cup holders.

NB: Item 138-159-160-190 are unfinished on the sides, must be used between 2 seats.

Each storage item has 2 USB ports and one electrical outlet inside the storage.



#### SUGGESTED CONFIGURATIONS



## MANHATTAN

### FEATURES:

- Manual adjustable headrest on all items (stationary on wedge).
- \*Wall hugger power recliners with full footrest (manual n/a).
- Power recliner lounge chair (manual n/a) with power headrest in option. Wall clearance 8" & front 5".
- Seat cushions with shaped foam + 1" layer of memory foam on top; arm with memory foam.
- Stitching: Small thread in fabric & large flat thread in leather.
- \*Excludes 043 & 163 chairs: Wall clearance 16"

Note: 2 recliner seats separated by a corner can not be opened at the same time. No recliner seats beside item #155.

### OPTIONS

- Battery Pack: Add \$160/ea.
- \*Motorized headrest: Add \$160 ea. (\*N/A on stationary items).
- Foam: Extra firm add \$15/seat.
- Choice of Large or Small 6" Arm: Leg on LARGE arm: LG187 wood or Metal: LG189 cyl. (Black or Chrome) or LG64 (sq). SMALL Arm: LG08 wood or Metal: LG196 cyl. (Black or Chrome) or LG64 (sq). Specify colour.
- Seat Depth: 20" or \*22". \*22" seat depth N/A on chairs 043 & 163.
- 043 & 163 Chairs: with wood base (specify colour).

### HOME THEATRE Configurations

For Accessories, Cup holders & Configuration details, see Optima Home Theatre page attached.

Accessory Dock : \$35 ea.

Cup Holders: Metal: \$25 ea. | LED lighted Cup Holder: \$25 ea. | \*LED lighted Cup Holder with (1 or 2 motor) controls: \$40 ea.

\*LED Light strip under seat: \$25/seat.

| Description                        | L x D x H   | Leather |                       |  |  |                                  |                            | Fabric |          |           |
|------------------------------------|-------------|---------|-----------------------|--|--|----------------------------------|----------------------------|--------|----------|-----------|
|                                    |             | 10      | 20<br>Madras<br>Softy | 30<br>Hugo<br>Fantasy<br>Illusion<br>Tucson<br>Utah<br>Vintage<br>Wild Laredo<br>Yukon | 40<br>Elegance<br>Princess<br>Santiago<br>Sensation<br>Sunset<br>Trina<br>Victoria | 50<br>Bull<br>Cassiope<br>Dublin | 60<br>Caresse<br>Ultrasued | A      | B<br>COM | C<br>alta |
| 001 CHAIR                          | 42x40x33/40 | 1890    | 1980                  | 2070   | 2160   | 2250                             | 2340                       | 1535   | 1580     | 1625      |
| 002 LOVESEAT                       | 65x40x33/40 | 2700    | 2815                  | 2930   | 3045   | 3160                             | 3275                       | 2175   | 2250     | 2325      |
| 003 SOFA                           | 89x40x33/40 | 3265    | 3415                  | 3565   | 3715   | 3865                             | 4015                       | 2625   | 2715     | 2805      |
| 005 LOUNGE CHAIR RIGHT ARM         | 33x62x33/40 | 1765    | 1830                  | 1895   | 1960   | 2025                             | 2090                       | 1410   | 1470     | 1530      |
| 009 ARMLESS LOVESEAT               | 47x40x33/40 | 1895    | 1965                  | 2035   | 2105   | 2175                             | 2245                       | 1490   | 1570     | 1650      |
| 011 LOUNGE CHAIR LEFT ARM          | 33x62x33/40 | 1765    | 1830                  | 1895   | 1960   | 2025                             | 2090                       | 1410   | 1470     | 1530      |
| 012 LOVESEAT LEFT ARM              | 56x40x33/40 | 2320    | 2420                  | 2520   | 2620   | 2720                             | 2820                       | 1850   | 1925     | 2000      |
| 017 DOUBLE CHAIR                   | 49x40x33/40 | 1980    | 2080                  | 2180   | 2280   | 2380                             | 2480                       | 1600   | 1660     | 1720      |
| 021 APARTMENT SOFA NO ARM          | 61x40x33/40 | 2140    | 2240                  | 2340   | 2440   | 2540                             | 2640                       | 1670   | 1755     | 1840      |
| 040 ARMLESS SOFA                   | 71x40x33/40 | 2450    | 2565                  | 2680   | 2795   | 2910                             | 3025                       | 1950   | 2040     | 2130      |
| 041 RECLINING CHAIR LEFT ARM       | 33x40x33/40 | 1885    | 1960                  | 2035   | 2110   | 2185                             | 2260                       | 1605   | 1640     | 1675      |
| 042 RECLINING CHAIR RIGHT ARM      | 33x40x33/40 | 1885    | 1960                  | 2035   | 2110   | 2185                             | 2260                       | 1605   | 1640     | 1675      |
| 043 SWIVEL ROCKING RECLINING CHAIR | 30x34x42    | 2235    | 2345                  | 2455   | 2565   | 2675                             | 2785                       | 1875   | 1920     | 1965      |
| 044 RECLINER CHAIR                 | 42x40x33/40 | 2275    | 2365                  | 2455   | 2545   | 2635                             | 2725                       | 1920   | 1970     | 2020      |
| 045 ARMLESS LOVESEAT BUMPER RIGHT  | 68x40x33/40 | 2245    | 2340                  | 2435   | 2530   | 2625                             | 2720                       | 1785   | 1850     | 1915      |
| 050 WEDGE                          | 49x49x33    | 1645    | 1745                  | 1845   | 1945   | 2045                             | 2145                       | 1210   | 1270     | 1330      |



## MANHATTAN

### FEATURES:

- Manual adjustable headrest on all items (stationary on wedge).
- \*Wall hugger power recliners with full footrest (manual n/a).
- Power recliner lounge chair (manual n/a) with power headrest in option. Wall clearance 8" & front 5".
- Seat cushions with shaped foam + 1" layer of memory foam on top; arm with memory foam.
- Stitching: Small thread in fabric & large flat thread in leather.
- \*Excludes 043 & 163 chairs: Wall clearance 16"

Note: 2 recliner seats separated by a corner can not be opened at the same time. No recliner seats beside item #155.

### OPTIONS

- Battery Pack: Add \$160/ea.
- \*Motorized headrest: Add \$160 ea. (\*N/A on stationary items).
- Foam: Extra firm add \$15/seat.
- Choice of Large or Small 6" Arm: Leg on LARGE arm: LG187 wood or Metal: LG189 cyl. (Black or Chrome) or LG64 (sq). SMALL Arm: LG08 wood or Metal: LG196 cyl. (Black or Chrome) or LG64 (sq). Specify colour.
- Seat Depth: 20" or \*22". \*22" seat depth N/A on chairs 043 & 163.
- 043 & 163 Chairs: with wood base (specify colour).

### HOME THEATRE Configurations

For Accessories, Cup holders & Configuration details, see Optima Home Theatre page attached.

Accessory Dock : \$35 ea.

Cup Holders: Metal: \$25 ea. | LED lighted Cup Holder: \$25 ea. | \*LED lighted Cup Holder with (1 or 2 motor) controls: \$40 ea.

\*LED Light strip under seat: \$25/seat.

| Description                      | L x D x H     | Leather |                       |  |  |                                  |                            | Fabric |          |           |
|----------------------------------|---------------|---------|-----------------------|--|--|----------------------------------|----------------------------|--------|----------|-----------|
|                                  |               | 10      | 20<br>Madras<br>Softy | 30<br>Hugo<br>Fantasy<br>Illusion<br>Tucson<br>Utah<br>Vintage<br>Wild Laredo<br>Yukon | 40<br>Elegance<br>Princess<br>Santiago<br>Sensation<br>Sunset<br>Trina<br>Victoria | 50<br>Bull<br>Cassiope<br>Dublin | 60<br>Caresse<br>Ultrasued | A      | B<br>COM | C<br>alta |
| 051 ARMLESS CHAIR                | 23,5x40x33/40 | 1085    | 1135                  | 1185   | 1235   | 1285                             | 1335                       | 845    | 900      | 955       |
| 052 SOFA LEFT ARM                | 80x40x33/40   | 2870    | 3005                  | 3140   | 3275   | 3410                             | 3545                       | 2290   | 2385     | 2480      |
| 053 SOFA RIGHT ARM               | 80x40x33/40   | 2870    | 3005                  | 3140   | 3275   | 3410                             | 3545                       | 2290   | 2385     | 2480      |
| 055 SQUARE CORNER                | 44x44x33/40   | 1915    | 2010                  | 2105   | 2200   | 2295                             | 2390                       | 1510   | 1565     | 1620      |
| 056 CHAIR RIGHT ARM              | 33x40x33/40   | 1510    | 1575                  | 1640   | 1705   | 1770                             | 1835                       | 1200   | 1260     | 1320      |
| 057 CHAIR LEFT ARM               | 33x40x33/40   | 1510    | 1575                  | 1640   | 1705   | 1770                             | 1835                       | 1200   | 1260     | 1320      |
| 061 LOVESEAT RIGHT ARM           | 56x40x33/40   | 2320    | 2420                  | 2520   | 2620   | 2720                             | 2820                       | 1850   | 1925     | 2000      |
| 071 ARMLESS RECLINING CHAIR      | 23,5x40x33/40 | 1470    | 1525                  | 1580   | 1635   | 1690                             | 1745                       | 1250   | 1310     | 1370      |
| 086 ARMLESS LOVESEAT BUMPER LEFT | 68x40x33/40   | 2245    | 2340                  | 2435   | 2530   | 2625                             | 2720                       | 1785   | 1850     | 1915      |
| 088 ARMLESS CHAIR BUMPER LEFT    | 45x40x33/40   | 1440    | 1535                  | 1630   | 1725   | 1820                             | 1915                       | 1130   | 1165     | 1200      |
| 089 ARMLESS CHAIR BUMPER RIGHT   | 45x40x33/40   | 1440    | 1535                  | 1630   | 1725   | 1820                             | 1915                       | 1130   | 1165     | 1200      |
| 095 APARTMENT SOFA               | 79x40x33/40   | 2940    | 3085                  | 3230   | 3375   | 3520                             | 3665                       | 2350   | 2445     | 2540      |
| 096 APARTMENT SOFA LEFT ARM      | 70x40x33/40   | 2570    | 2680                  | 2790   | 2900   | 3010                             | 3120                       | 2020   | 2110     | 2200      |
| 097 APARTMENT SOFA RIGHT ARM     | 70x40x33/40   | 2570    | 2680                  | 2790   | 2900   | 3010                             | 3120                       | 2020   | 2110     | 2200      |
| 124 STORAGE OTTOMAN              | 30x22x17      | 745     | 765                   | 785  | 805  | 825                              | 845                        | 650    | 670      | 690       |
| 138 STRAIGHT ARM                 | 9x36x24       | 415     | 450                   | 485  | 520  | 555                              | 590                        | 350    | 365      | 380       |

## MANHATTAN

### FEATURES:

- Manual adjustable headrest on all items (stationary on wedge).
- \*Wall hugger power recliners with full footrest (manual n/a).
- Power recliner lounge chair (manual n/a) with power headrest in option. Wall clearance 8" & front 5".
- Seat cushions with shaped foam + 1" layer of memory foam on top; arm with memory foam.
- Stitching: Small thread in fabric & large flat thread in leather.
- \*Excludes 043 & 163 chairs: Wall clearance 16"

Note: 2 recliner seats separated by a corner can not be opened at the same time. No recliner seats beside item #155.

### OPTIONS

- Battery Pack: Add \$160/ea.
- \*Motorized headrest: Add \$160 ea. (\*N/A on stationary items).
- Foam: Extra firm add \$15/seat.
- Choice of Large or Small 6" Arm: Leg on LARGE arm: LG187 wood or Metal: LG189 cyl. (Black or Chrome) or LG64 (sq). SMALL Arm: LG08 wood or Metal: LG196 cyl. (Black or Chrome) or LG64 (sq). Specify colour.
- Seat Depth: 20" or \*22". \*22" seat depth N/A on chairs 043 & 163.
- 043 & 163 Chairs: with wood base (specify colour).

### HOME THEATRE Configurations

For Accessories, Cup holders & Configuration details, see Optima Home Theatre page attached.

Accessory Dock : \$35 ea.

Cup Holders: Metal: \$25 ea. | LED lighted Cup Holder: \$25 ea. | \*LED lighted Cup Holder with (1 or 2 motor) controls: \$40 ea.

\*LED Light strip under seat: \$25/seat.

| Description                            | L x D x H     | Leather |                       |  |  |                                  |                           | Fabric |          |           |
|--|---------------|---------|-----------------------|--|--|----------------------------------|---------------------------|--------|----------|-----------|
|  |               | 10      | 20<br>Madras<br>Softy | 30<br>Hugo<br>Fantasy<br>Illusion<br>Tucson<br>Utah<br>Vintage<br>Wild Laredo<br>Yukon | 40<br>Elegance<br>Princess<br>Santiago<br>Sensation<br>Sunset<br>Trina<br>Victoria | 50<br>Bull<br>Cassiope<br>Dublin | 60<br>Caress<br>Ultrasued | A      | B<br>COM | C<br>alta |
| 155 SMALL SQUARE CORNER                | 40x40x33/40   | 1915    | 2010                  | 2105   | 2200   | 2295                             | 2390                      | 1510   | 1565     | 1620      |
| 159 WEDGE STORAGE                      | 12/27x36x24   | 745     | 775                   | 805  | 835  | 865                              | 895                       | 585    | 600      | 615       |
| 160 STRAIGHT STORAGE                   | 12x36x24      | 720     | 745                   | 770  | 795  | 820                              | 845                       | 550    | 570      | 590       |
| 163 DBL SWIVEL ROCKING RECLINER CHAIR  | 33x34x42      | 2290    | 2410                  | 2530   | 2650   | 2770                             | 2890                      | 1880   | 1930     | 1980      |
| 165 DOUBLE RECLINING CHAIR             | 49x40x33/40   | 2375    | 2475                  | 2575   | 2675   | 2775                             | 2875                      | 2000   | 2065     | 2130      |
| 167 APARTMENT SOFA NO ARM BUMPER LEFT  | 82x40x33/40   | 2490    | 2620                  | 2750   | 2880   | 3010                             | 3140                      | 1960   | 2045     | 2130      |
| 168 APARTMENT SOFA NO ARM BUMPER RIGHT | 82x40x33/40   | 2490    | 2620                  | 2750   | 2880   | 3010                             | 3140                      | 1960   | 2045     | 2130      |
| 169 DOUBLE RECLINING CHAIR LEFT ARM    | 40x40x33/40   | 1990    | 2070                  | 2150   | 2230   | 2310                             | 2390                      | 1670   | 1750     | 1830      |
| 170 DOUBLE RECLINING CHAIR RIGHT ARM   | 40x40x33/40   | 1990    | 2070                  | 2150   | 2230   | 2310                             | 2390                      | 1670   | 1750     | 1830      |
| 171 ARMLESS DOUBLE RECLINING CHAIR     | 30,5x40x33/40 | 1575    | 1625                  | 1675   | 1725   | 1775                             | 1825                      | 1320   | 1380     | 1440      |
| 173 DOUBLE LOUNGE CHAIR LEFT ARM       | 40x62x33/40   | 1915    | 2005                  | 2095   | 2185   | 2275                             | 2365                      | 1535   | 1615     | 1695      |
| 174 DOUBLE LOUNGE CHAIR RIGHT ARM      | 40x62x33/40   | 1915    | 2005                  | 2095   | 2185   | 2275                             | 2365                      | 1535   | 1615     | 1695      |
| 175 DOUBLE CHAIR LEFT ARM              | 40x40x33/40   | 1590    | 1680                  | 1770   | 1860   | 1950                             | 2040                      | 1285   | 1350     | 1415      |
| 176 DOUBLE CHAIR RIGHT ARM             | 40x40x33/40   | 1590    | 1680                  | 1770   | 1860   | 1950                             | 2040                      | 1285   | 1350     | 1415      |
| 177 ARMLESS DOUBLE CHAIR               | 30,5x40x33/40 | 1185    | 1250                  | 1315   | 1380   | 1445                             | 1510                      | 915    | 970      | 1025      |
| 178 ARMLESS DOUBLE CHAIR BUMPER LEFT   | 52x40x33/40   | 1545    | 1625                  | 1705   | 1785   | 1865                             | 1945                      | 1230   | 1290     | 1350      |



## MANHATTAN

**FEATURES:**

- Manual adjustable headrest on all items (stationary on wedge).
- \*Wall hugger power recliners with full footrest (manual n/a).
- Power recliner lounge chair (manual n/a) with power headrest in option. Wall clearance 8" & front 5".
- Seat cushions with shaped foam + 1" layer of memory foam on top; arm with memory foam.
- Stitching: Small thread in fabric & large flat thread in leather.
- \*Excludes 043 & 163 chairs: Wall clearance 16"

Note: 2 recliner seats separated by a corner can not be opened at the same time. No recliner seats beside item #155.

**OPTIONS**

- Battery Pack: Add \$160/ea.
- \*Motorized headrest: Add \$160 ea. (\*N/A on stationary items).
- Foam: Extra firm add \$15/seat.
- Choice of Large or Small 6" Arm: Leg on LARGE arm: LG187 wood or Metal: LG189 cyl. (Black or Chrome) or LG64 (sq). SMALL Arm: LG08 wood or Metal: LG196 cyl. (Black or Chrome) or LG64 (sq). Specify colour.
- Seat Depth: 20" or \*22". \*22" seat depth N/A on chairs 043 & 163.
- 043 & 163 Chairs: with wood base (specify colour).

**HOME THEATRE Configurations**

For Accessories, Cup holders & Configuration details, see Optima Home Theatre page attached.

Accessory Dock : \$35 ea.

Cup Holders: Metal: \$25 ea. | LED lighted Cup Holder: \$25 ea. | \*LED lighted Cup Holder with (1 or 2 motor) controls: \$40 ea.

\*LED Light strip under seat: \$25/seat.

| Description                            | L x D x H       | Leather |                       |  |  |                                  |                           | Fabric |          |           |
|--|-----------------|---------|-----------------------|--|--|----------------------------------|---------------------------|--------|----------|-----------|
|  |                 | 10      | 20<br>Madras<br>Softy | 30<br>Hugo<br>Fantasy<br>Illusion<br>Tucson<br>Utah<br>Vintage<br>Wild Laredo<br>Yukon | 40<br>Elegance<br>Princess<br>Santiago<br>Sensation<br>Sunset<br>Trina<br>Victoria | 50<br>Bull<br>Cassiope<br>Dublin | 60<br>Caress<br>Ultrasued | A      | B<br>COM | C<br>alta |
| 179 ARMLESS DOUBLE CHAIR BUMPER RIGHT  | 52x40x33/40     | 1545    | 1625                  | 1705   | 1785   | 1865                             | 1945                      | 1230   | 1290     | 1350      |
| 186 ARMLESS LOVESEAT BUMPER STORAGE-L  | 68x40x33/40     | 2420    | 2500                  | 2580   | 2660   | 2740                             | 2820                      | 1950   | 2015     | 2080      |
| 187 ARMLESS LOVESEAT BUMPER STORAGE-R  | 68x40x33/40     | 2420    | 2500                  | 2580   | 2660   | 2740                             | 2820                      | 1950   | 2015     | 2080      |
| 188 ARMLESS CHAIR BUMPER STORAGE-L     | 45x40x33/40     | 1600    | 1690                  | 1780   | 1870   | 1960                             | 2050                      | 1295   | 1330     | 1365      |
| 189 ARMLESS CHAIR BUMPER STORAGE-R     | 45x40x33/40     | 1600    | 1690                  | 1780   | 1870   | 1960                             | 2050                      | 1295   | 1330     | 1365      |
| 190 SMALL WEDGE STORAGE                | 12/21x36x24     | 720     | 745                   | 770  | 795  | 820                              | 845                       | 550    | 570      | 590       |
| 221 ARMLESS DBL CHAIR BUMPER STORAGE-L | 52x40x33/40     | 1705    | 1790                  | 1875   | 1960   | 2045                             | 2130                      | 1390   | 1450     | 1510      |
| 222 ARMLESS DBL CHAIR BUMPER STORAGE-R | 52x40x33/40     | 1705    | 1790                  | 1875   | 1960   | 2045                             | 2130                      | 1390   | 1450     | 1510      |
| 223 APT SOFA NO ARM BUMPER STORAGE-L   | 82x40x33/40     | 2655    | 2785                  | 2915   | 3045   | 3175                             | 3305                      | 2120   | 2215     | 2310      |
| 224 APT SOFA NO ARM BUMPER STORAGE-R   | 82x40x33/40     | 2655    | 2785                  | 2915   | 3045   | 3175                             | 3305                      | 2120   | 2215     | 2310      |
| 236 RECLINING LOUNGE CHAIR LEFT ARM    | 33x62x33/40     | 2160    | 2225                  | 2290   | 2355   | 2420                             | 2485                      | 1820   | 1880     | 1940      |
| 237 RECLINING LOUNGE CHAIR RIGHT ARM   | 33x62x33/40     | 2160    | 2225                  | 2290   | 2355   | 2420                             | 2485                      | 1820   | 1880     | 1940      |
| 238 RECLINING DBL LOUNGE CHAIR L-ARM   | 40x62x33/40     | 2315    | 2405                  | 2495   | 2585   | 2675                             | 2765                      | 1940   | 2020     | 2100      |
| 239 RECLINING DBL LOUNGE CHAIR R-ARM   | 40x62x33/40     | 2315    | 2405                  | 2495   | 2585   | 2675                             | 2765                      | 1940   | 2020     | 2100      |
| V51 WINE GLASS HOLDER                  | 3.5 x 5.5 x 6.5 | 35      | 35                    | 35   | 35   | 35                               | 35                        | 35     | 35       | 35        |
| V52 PLASTIC SWIVEL TRAY                | 13 3/8 x 9 5/8  | 35      | 35                    | 35   | 35   | 35                               | 35                        | 35     | 35       | 35        |

## MANHATTAN

### FEATURES:

- Manual adjustable headrest on all items (stationary on wedge).
- \*Wall hugger power recliners with full footrest (manual n/a).
- Power recliner lounge chair (manual n/a) with power headrest in option. Wall clearance 8" & front 5".
- Seat cushions with shaped foam + 1" layer of memory foam on top; arm with memory foam.
- Stitching: Small thread in fabric & large flat thread in leather.
- \*Excludes 043 & 163 chairs: Wall clearance 16"

Note: 2 recliner seats separated by a corner can not be opened at the same time. No recliner seats beside item #155.

### OPTIONS

- Battery Pack: Add \$160/ea.
- \*Motorized headrest: Add \$160 ea. (\*N/A on stationary items).
- Foam: Extra firm add \$15/seat.
- Choice of Large or Small 6" Arm: Leg on LARGE arm: LG187 wood or Metal: LG189 cyl. (Black or Chrome) or LG64 (sq). SMALL Arm: LG08 wood or Metal: LG196 cyl. (Black or Chrome) or LG64 (sq). Specify colour.
- Seat Depth: 20" or \*22". \*22" seat depth N/A on chairs 043 & 163.
- 043 & 163 Chairs: with wood base (specify colour).

### HOME THEATRE Configurations

For Accessories, Cup holders & Configuration details, see Optima Home Theatre page attached.

Accessory Dock : \$35 ea.

Cup Holders: Metal: \$25 ea. | LED lighted Cup Holder: \$25 ea. | \*LED lighted Cup Holder with (1 or 2 motor) controls: \$40 ea.

\*LED Light strip under seat: \$25/seat.

| Description                 | L x D x H          | Leather |                       |  |  |                                  |                           | Fabric |          |           |
|-----------------------------|--------------------|---------|-----------------------|--|--|----------------------------------|---------------------------|--------|----------|-----------|
|                             |                    | 10      | 20<br>Madras<br>Softy | 30<br>Hugo<br>Fantasy<br>Illusion<br>Tucson<br>Utah<br>Vintage<br>Wild Laredo<br>Yukon | 40<br>Elegance<br>Princess<br>Santiago<br>Sensation<br>Sunset<br>Trina<br>Victoria | 50<br>Bull<br>Cassiope<br>Dublin | 60<br>Caress<br>Ultrasued | A      | B<br>COM | C<br>alta |
| V53 WOOD SWIVEL TRAY        | 19 x 10            | 60      | 60                    | 60   | 60   | 60                               | 60                        | 60     | 60       | 60        |
| V54 TABLET HOLDER           | 4.5 x 8 x 10       | 40      | 40                    | 40   | 40   | 40                               | 40                        | 40     | 40       | 40        |
| V55 LED LAMP                | 1.5x5x14 plié/bent | 35      | 35                    | 35   | 35   | 35                               | 35                        | 35     | 35       | 35        |
| <b>CONFIGURATIONS</b>       |                    |         |                       |  |  |                                  |                           |        |          |           |
| _A CONFIG (169-170)         | 80X40X40           | 3980    | 4140                  | 4300   | 4460   | 4620                             | 4780                      | 3340   | 3500     | 3660      |
| _B CONFIG (169-171-174)     | 111X62X40          | 5480    | 5700                  | 5920   | 6140   | 6360                             | 6580                      | 4525   | 4745     | 4965      |
| _C CONFIG (096-055-171-170) | 115X115X40         | 8050    | 8385                  | 8720   | 9055   | 9390                             | 9725                      | 6520   | 6805     | 7090      |
| _D CONFIG (169-171-055-179) | 115X96X40          | 7025    | 7330                  | 7635   | 7940   | 8245                             | 8550                      | 5730   | 5985     | 6240      |
| _J CONFIG (041-042)         | 66X40X40           | 3770    | 3920                  | 4070   | 4220   | 4370                             | 4520                      | 3210   | 3280     | 3350      |
| _K CONFIG (041-071-005)     | 90X62X40           | 5120    | 5315                  | 5510   | 5705   | 5900                             | 6095                      | 4265   | 4420     | 4575      |
| _L CONFIG (012-055-071-042) | 101X101X40         | 7590    | 7915                  | 8240   | 8565   | 8890                             | 9215                      | 6215   | 6440     | 6665      |
| _M CONFIG (041-071-055-089) | 101X89X40          | 6710    | 7030                  | 7350   | 7670   | 7990                             | 8310                      | 5495   | 5680     | 5865      |



# MANHATTAN

**OPTIMA**  
Collection

**Jaymar**

Conçu et fabriqué fièrement au Canada  
Proudly designed and made in Canada

Nos produits sont fabriqués à la main et des variations mineures peuvent survenir.

Our product is hand-made and minor variations can occur.

## SPECIFICATIONS

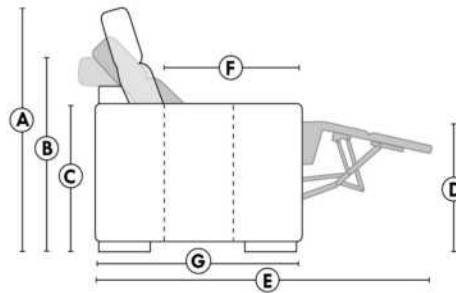

- Appui-tête levé / Headrest up
- Appui-tête baissé / Headrest down
- Complètement incliné / Fully reclined

- A** Hauteur complète 40" Total Height
- B** Hauteur appui-tête baissé 33" Height headrest down
- C** Hauteur du bras 24" Arm Height
- D** Hauteur du siège 19,5" Seat height
- E** Profondeur inclinée 65" Depth fully reclined
- F** Profondeur d'assise 20"ou/ou 22" Seat depth
- G** Profondeur appui-tête monté 37,5" Depth with headrest up

## BRAS | ARMS

Option de bras:  
Bras Régulier Large 9" ou Petit bras 6"

Arm option  
Regular arm Large 9" or Small arm 6"

Contrôle de l'inclinaison situé à l'intérieur du bras  
Recliner control located on the inside of the arm.

Option d'accessoires disponible sur le bras régulier seulement  
Accessories option, available on Regular arms ONLY.

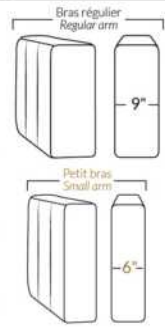

## FAUTEUIL BERÇANT PIVOTANT INCLINABLE SWIVEL ROCKING MOTION CHAIR



## SIÈGE 23" DE LARGE | 23" SEAT WIDTH

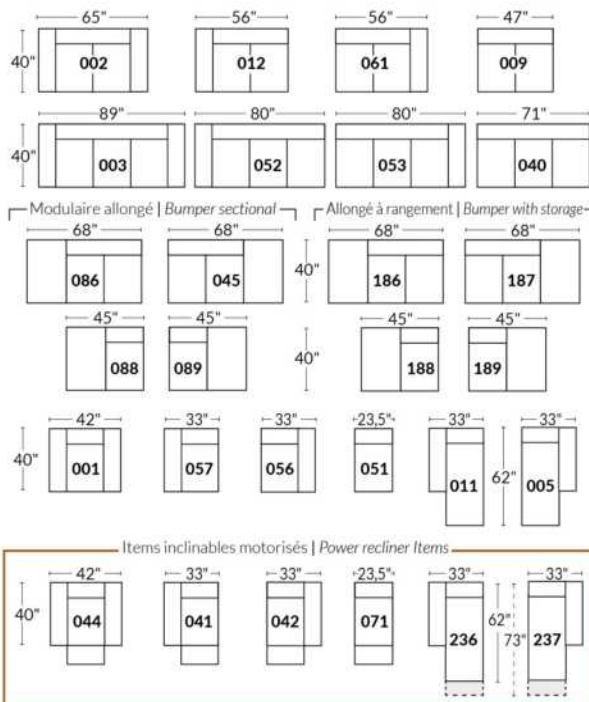

## SIÈGE 30" DE LARGE | 30" SEAT WIDTH

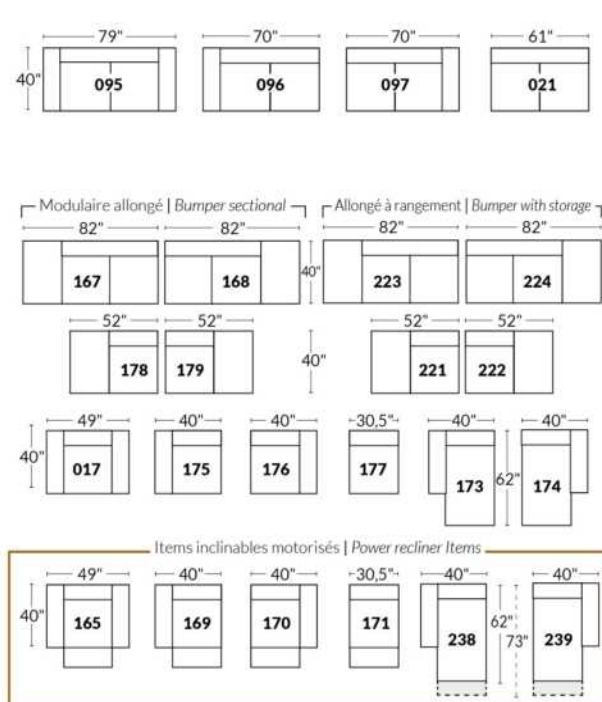

### Autres | Others

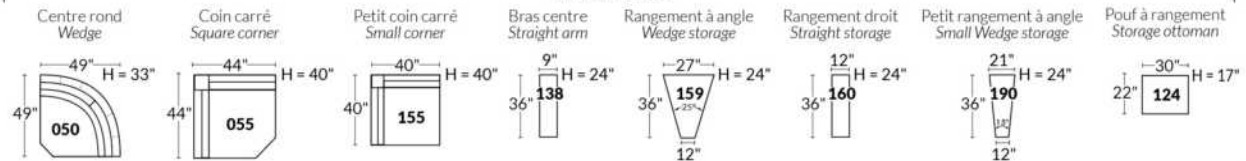

### EXEMPLE 23" EXAMPLE

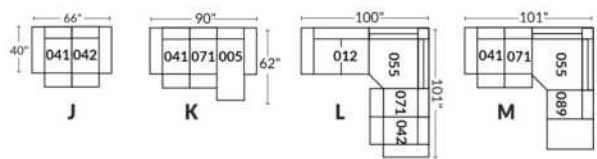

### EXEMPLE 30" EXAMPLE

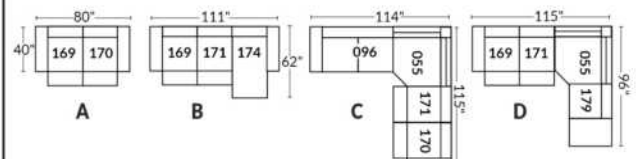

\*Available on certain models and on large arms ONLY.

### OPTIONS CUP HOLDERS

#### METAL



Silver



Matte Black



Brown

#### ILLUMINATED

1.



LED Lighted Cup holder

2.



LED Lighted Cup holder with Single Motor Control, USB Port and LED Base rail

3.



LED Lighted Cup holder with Dual Motor Control, USB Port and LED Base rail

Our illuminated one or two-control cup holders are compatible with LED lights under the seat. You can control the light on the cup holder. The 2 motor cup holder has a reset (home) button control to close your recliner back to its starting position.

#### LED Light under seat (Optional)

Available only in configurations with a minimum of 1 illuminated motorized cup holder with control buttons. The "light" button will control the opening and closing of the light.

For cup holder prices see description section of the Optima model price list.

Please provide us with a drawing of your configuration which indicates the cup holder type and its positioning.

#### Cup holder with controller:

It is important to specify the placement of the cups; on left arm or right arm and which recliner they will control. If you have a row of several seats with cup holders, by default, the controls will be on the left arms and on the right arm for the last outer chair.

#### EXAMPLE A:

041-169: Controller and cup holder on the left arm

071-171: hidden touch sensor buttons on side of seat

042-170: Controller and cup holder on right arm



#### EXAMPLE B:

071-171: These two items can be connected to a smart cup holder which will control the recliner. You must then use one of these items: 138,159, 160 and 190



#### Informations about headrest, controller on reclining seat

#### WITH illuminated cup holder

If you have a **stationary item**, you will have cup holder N°1.

If you have a recliner chair with a **manual headrest**, you will have the cup holder N°2.

If you have a recliner chair with an **electric headrest**, you will have cup holder N°3.

#### Without cup holder and with a reclining seat

If you have a recliner with a **manual headrest** you will have the touch sensor button control on the side of the seat.

If you have a recliner with an **electric headrest** you will have a dual push button controller with USB port on the arm.

If you have an **armless recliner**, you will have the hidden touch sensor button control.



Hidden touch sensor



Dual push button

# OPTIMA

## HOME THEATRE Configurations

\*Available on certain models and on large arms ONLY.

OPTIONS

### ACCESSORIES

Accessory Dock



V51 Wine Glass Holder



V52 Plastic Swivel Tray Table



V53 Wood Swivel tray Table  
(Choice of 8 colors)



Specify on which arm (left or right) the tray table will be installed.

V54 Tablet Holder



V55 LED Lamp



(For Accessory Dock price, see description section of the Optima model price list and for Accessory item prices, see at very end of the price list)

### Items 138-159-160-190 and large arm.

Accessory docks and cups are Optional. \*Not available on small arms\*

Please specify on which arms you want the accessory docks and cup holders.

NB: Item 138-159-160-190 are unfinished on the sides, must be used between 2 seats.

Each storage item has 2 USB ports and one electrical outlet inside the storage.



### SUGGESTED CONFIGURATIONS

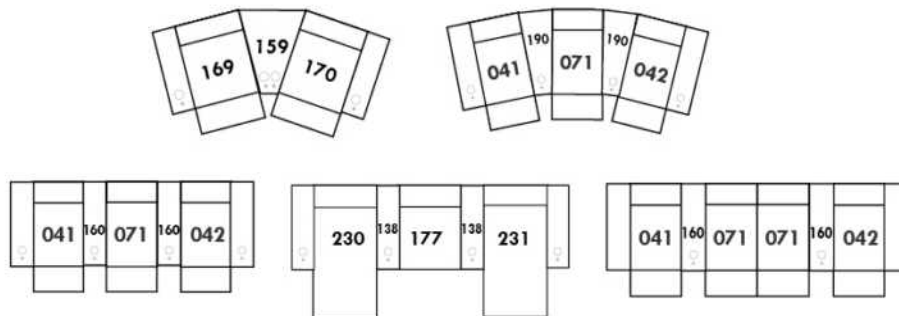

## MARSEILLE

**FEATURES:**

- Manual adjustable headrest on all items (2 on square corner & stationary on wedge).
- \*Wall hugger power recliners with full footrest (manual n/a).
- Power recliner lounge chair (manual n/a) with power headrest in option. Wall clearance 8" & front 5".
- Seat cushions with shaped foam + 1" layer of memory foam on top; arm with memory foam.
- Stitching: Small thread in fabric & large flat thread in leather.
- \*Excludes 043 & 163 chairs: Wall clearance 16"

Note: 2 recliner seats separated by a corner can not be opened at the same time. No recliner seats beside item #155.

**OPTIONS**

- Battery Pack: Add \$160/ea.
- \*Motorized headrest: Add \$160 ea. (\*N/A on stationary items).
- Foam: Extra firm add \$15/seat.
- Choice of Large or Small 6" Arm: Leg on LARGE arm: LG103 wood or LG189 metal (Black or Chrome). SMALL Arm: LG08 wood or Metal: LG196 cyl. (Black or Chrome) or LG64 (sq). Specify colour.
- Seat Depth: 20" or \*22". \*22" seat depth N/A on chairs 043 & 163.
- 043 & 163 Chairs: with wood base (specify colour).

**HOME THEATRE Configurations**

For Accessories, Cup holders & Configuration details, see Optima Home Theatre page attached.

Accessory Dock : \$35 ea.

Cup Holders: Metal: \$25 ea. | LED lighted Cup Holder: \$25 ea. | \*LED lighted Cup Holder with (1 or 2 motor) controls: \$40 ea.

\*LED Light strip under seat: \$25/seat.

| Description                        | L x D x H   | Leather |                       |  |  |                                  |                            | Fabric |          |           |
|------------------------------------|-------------|---------|-----------------------|--|--|----------------------------------|----------------------------|--------|----------|-----------|
|                                    |             | 10      | 20<br>Madras<br>Softy | 30<br>Hugo<br>Fantasy<br>Illusion<br>Tucson<br>Utah<br>Vintage<br>Wild Laredo<br>Yukon | 40<br>Elegance<br>Princess<br>Santiago<br>Sensation<br>Sunset<br>Trina<br>Victoria | 50<br>Bull<br>Cassiope<br>Dublin | 60<br>Caresse<br>Ultrasued | A      | B<br>COM | C<br>alta |
| 001 CHAIR                          | 44x40x33/40 | 1890    | 1980                  | 2070   | 2160   | 2250                             | 2340                       | 1535   | 1580     | 1625      |
| 002 LOVESEAT                       | 67x40x33/40 | 2700    | 2815                  | 2930   | 3045   | 3160                             | 3275                       | 2175   | 2250     | 2325      |
| 003 SOFA                           | 91x40x33/40 | 3265    | 3415                  | 3565   | 3715   | 3865                             | 4015                       | 2625   | 2715     | 2805      |
| 005 LOUNGE CHAIR RIGHT ARM         | 34X62X33/40 | 1765    | 1830                  | 1895   | 1960   | 2025                             | 2090                       | 1410   | 1470     | 1530      |
| 009 ARMLESS LOVESEAT               | 47x40x33/40 | 1895    | 1965                  | 2035   | 2105   | 2175                             | 2245                       | 1490   | 1570     | 1650      |
| 011 LOUNGE CHAIR LEFT ARM          | 34x62x33/40 | 1765    | 1830                  | 1895   | 1960   | 2025                             | 2090                       | 1410   | 1470     | 1530      |
| 012 LOVESEAT LEFT ARM              | 57x40x33/40 | 2320    | 2420                  | 2520   | 2620   | 2720                             | 2820                       | 1850   | 1925     | 2000      |
| 017 DOUBLE CHAIR                   | 51x40x33/40 | 1980    | 2080                  | 2180   | 2280   | 2380                             | 2480                       | 1600   | 1660     | 1720      |
| 021 APARTMENT SOFA NO ARM          | 61x40x33/40 | 2140    | 2240                  | 2340   | 2440   | 2540                             | 2640                       | 1670   | 1755     | 1840      |
| 040 ARMLESS SOFA                   | 71x40x33/40 | 2450    | 2565                  | 2680   | 2795   | 2910                             | 3025                       | 1950   | 2040     | 2130      |
| 041 RECLINING CHAIR LEFT ARM       | 34x40x33/40 | 1885    | 1960                  | 2035   | 2110   | 2185                             | 2260                       | 1605   | 1640     | 1675      |
| 042 RECLINING CHAIR RIGHT ARM      | 34x40x33/40 | 1885    | 1960                  | 2035   | 2110   | 2185                             | 2260                       | 1605   | 1640     | 1675      |
| 043 SWIVEL ROCKING RECLINING CHAIR | 30x34x42    | 2235    | 2345                  | 2455   | 2565   | 2675                             | 2785                       | 1875   | 1920     | 1965      |
| 044 RECLINER CHAIR                 | 44x40x33/40 | 2275    | 2365                  | 2455   | 2545   | 2635                             | 2725                       | 1920   | 1970     | 2020      |
| 045 ARMLESS LOVESEAT BUMPER RIGHT  | 68x40x33/40 | 2245    | 2340                  | 2435   | 2530   | 2625                             | 2720                       | 1785   | 1850     | 1915      |
| 050 WEDGE                          | 49x49x33    | 1645    | 1745                  | 1845   | 1945   | 2045                             | 2145                       | 1210   | 1270     | 1330      |



## MARSEILLE

**FEATURES:**

- Manual adjustable headrest on all items (2 on square corner & stationary on wedge).
- \*Wall hugger power recliners with full footrest (manual n/a).
- Power recliner lounge chair (manual n/a) with power headrest in option. Wall clearance 8" & front 5".
- Seat cushions with shaped foam + 1" layer of memory foam on top; arm with memory foam.
- Stitching: Small thread in fabric & large flat thread in leather.
- \*Excludes 043 & 163 chairs: Wall clearance 16"

Note: 2 recliner seats separated by a corner can not be opened at the same time. No recliner seats beside item #155.

**OPTIONS**

- Battery Pack: Add \$160/ea.
- \*Motorized headrest: Add \$160 ea. (\*N/A on stationary items).
- Foam: Extra firm add \$15/seat.
- Choice of Large or Small 6" Arm: Leg on LARGE arm: LG103 wood or LG189 metal (Black or Chrome). SMALL Arm: LG08 wood or Metal: LG196 cyl. (Black or Chrome) or LG64 (sq). Specify colour.
- Seat Depth: 20" or \*22". \*22" seat depth N/A on chairs 043 & 163.
- 043 & 163 Chairs: with wood base (specify colour).

**HOME THEATRE Configurations**

For Accessories, Cup holders & Configuration details, see Optima Home Theatre page attached.

Accessory Dock : \$35 ea.

Cup Holders: Metal: \$25 ea. | LED lighted Cup Holder: \$25 ea. | \*LED lighted Cup Holder with (1 or 2 motor) controls: \$40 ea.

\*LED Light strip under seat: \$25/seat.

| Description                      | L x D x H     | Leather |                       |  |  |                                  |                            | Fabric |          |           |
|----------------------------------|---------------|---------|-----------------------|--|--|----------------------------------|----------------------------|--------|----------|-----------|
|                                  |               | 10      | 20<br>Madras<br>Softy | 30<br>Hugo<br>Fantasy<br>Illusion<br>Tucson<br>Utah<br>Vintage<br>Wild Laredo<br>Yukon | 40<br>Elegance<br>Princess<br>Santiago<br>Sensation<br>Sunset<br>Trina<br>Victoria | 50<br>Bull<br>Cassiope<br>Dublin | 60<br>Caresse<br>Ultrasued | A      | B<br>COM | C<br>alta |
| 051 ARMLESS CHAIR                | 23,5x40x33/40 | 1085    | 1135                  | 1185   | 1235   | 1285                             | 1335                       | 845    | 900      | 955       |
| 052 SOFA LEFT ARM                | 81x40x33/40   | 2870    | 3005                  | 3140   | 3275   | 3410                             | 3545                       | 2290   | 2385     | 2480      |
| 053 SOFA RIGHT ARM               | 81x40x33/40   | 2870    | 3005                  | 3140   | 3275   | 3410                             | 3545                       | 2290   | 2385     | 2480      |
| 055 SQUARE CORNER                | 44x44x33/40   | 1915    | 2010                  | 2105   | 2200   | 2295                             | 2390                       | 1510   | 1565     | 1620      |
| 056 CHAIR RIGHT ARM              | 34x40x33/40   | 1510    | 1575                  | 1640   | 1705   | 1770                             | 1835                       | 1200   | 1260     | 1320      |
| 057 CHAIR LEFT ARM               | 34x40x33/40   | 1510    | 1575                  | 1640   | 1705   | 1770                             | 1835                       | 1200   | 1260     | 1320      |
| 061 LOVESEAT RIGHT ARM           | 57x40x33/40   | 2320    | 2420                  | 2520   | 2620   | 2720                             | 2820                       | 1850   | 1925     | 2000      |
| 071 ARMLESS RECLINING CHAIR      | 23,5x40x33/40 | 1470    | 1525                  | 1580   | 1635   | 1690                             | 1745                       | 1250   | 1310     | 1370      |
| 086 ARMLESS LOVESEAT BUMPER LEFT | 68x40x33/40   | 2245    | 2340                  | 2435   | 2530   | 2625                             | 2720                       | 1785   | 1850     | 1915      |
| 088 ARMLESS CHAIR BUMPER LEFT    | 45x40x33/40   | 1440    | 1535                  | 1630   | 1725   | 1820                             | 1915                       | 1130   | 1165     | 1200      |
| 089 ARMLESS CHAIR BUMPER RIGHT   | 45x40x33/40   | 1440    | 1535                  | 1630   | 1725   | 1820                             | 1915                       | 1130   | 1165     | 1200      |
| 095 APARTMENT SOFA               | 81x40x33/40   | 2940    | 3085                  | 3230   | 3375   | 3520                             | 3665                       | 2350   | 2445     | 2540      |
| 096 APARTMENT SOFA LEFT ARM      | 71x40x33/40   | 2570    | 2680                  | 2790   | 2900   | 3010                             | 3120                       | 2020   | 2110     | 2200      |
| 097 APARTMENT SOFA RIGHT ARM     | 71x40x33/40   | 2570    | 2680                  | 2790   | 2900   | 3010                             | 3120                       | 2020   | 2110     | 2200      |
| 124 STORAGE OTTOMAN              | 30x22x17      | 745     | 765                   | 785  | 805  | 825                              | 845                        | 650    | 670      | 690       |
| 138 STRAIGHT ARM                 | 10x36x24      | 415     | 450                   | 485  | 520  | 555                              | 590                        | 350    | 365      | 380       |

## MARSEILLE

**FEATURES:**

- Manual adjustable headrest on all items (2 on square corner & stationary on wedge).
- \*Wall hugger power recliners with full footrest (manual n/a).
- Power recliner lounge chair (manual n/a) with power headrest in option. Wall clearance 8" & front 5".
- Seat cushions with shaped foam + 1" layer of memory foam on top; arm with memory foam.
- Stitching: Small thread in fabric & large flat thread in leather.
- \*Excludes 043 & 163 chairs: Wall clearance 16"

Note: 2 recliner seats separated by a corner can not be opened at the same time. No recliner seats beside item #155.

**OPTIONS**

- Battery Pack: Add \$160/ea.
- \*Motorized headrest: Add \$160 ea. (\*N/A on stationary items).
- Foam: Extra firm add \$15/seat.
- Choice of Large or Small 6" Arm: Leg on LARGE arm: LG103 wood or LG189 metal (Black or Chrome). SMALL Arm: LG08 wood or Metal: LG196 cyl. (Black or Chrome) or LG64 (sq). Specify colour.
- Seat Depth: 20" or \*22". \*22" seat depth N/A on chairs 043 & 163.
- 043 & 163 Chairs: with wood base (specify colour).

**HOME THEATRE Configurations**

For Accessories, Cup holders & Configuration details, see Optima Home Theatre page attached.

Accessory Dock : \$35 ea.

Cup Holders: Metal: \$25 ea. | LED lighted Cup Holder: \$25 ea. | \*LED lighted Cup Holder with (1 or 2 motor) controls: \$40 ea.

\*LED Light strip under seat: \$25/seat.

| Description                            | L x D x H     | Leather |                       |  |  |                                  |                           | Fabric |          |           |
|--|---------------|---------|-----------------------|--|--|----------------------------------|---------------------------|--------|----------|-----------|
|  |               | 10      | 20<br>Madras<br>Softy | 30<br>Hugo<br>Fantasy<br>Illusion<br>Tucson<br>Utah<br>Vintage<br>Wild Laredo<br>Yukon | 40<br>Elegance<br>Princess<br>Santiago<br>Sensation<br>Sunset<br>Trina<br>Victoria | 50<br>Bull<br>Cassiope<br>Dublin | 60<br>Caress<br>Ultrasued | A      | B<br>COM | C<br>alta |
| 155 SMALL SQUARE CORNER                | 40x40x33/40   | 1915    | 2010                  | 2105   | 2200   | 2295                             | 2390                      | 1510   | 1565     | 1620      |
| 159 WEDGE STORAGE                      | 11/27x36x24   | 745     | 775                   | 805  | 835  | 865                              | 895                       | 585    | 600      | 615       |
| 160 STRAIGHT STORAGE                   | 11x36x24      | 720     | 745                   | 770  | 795  | 820                              | 845                       | 550    | 570      | 590       |
| 163 DBL SWIVEL ROCKING RECLINER CHAIR  | 33x34x42      | 2290    | 2410                  | 2530   | 2650   | 2770                             | 2890                      | 1880   | 1930     | 1980      |
| 165 DOUBLE RECLINING CHAIR             | 51x40x33/40   | 2375    | 2475                  | 2575   | 2675   | 2775                             | 2875                      | 2000   | 2065     | 2130      |
| 167 APARTMENT SOFA NO ARM BUMPER LEFT  | 82x40x33/40   | 2490    | 2620                  | 2750   | 2880   | 3010                             | 3140                      | 1960   | 2045     | 2130      |
| 168 APARTMENT SOFA NO ARM BUMPER RIGHT | 82x40x33/40   | 2490    | 2620                  | 2750   | 2880   | 3010                             | 3140                      | 1960   | 2045     | 2130      |
| 169 DOUBLE RECLINING CHAIR LEFT ARM    | 41x40x33/40   | 1990    | 2070                  | 2150   | 2230   | 2310                             | 2390                      | 1670   | 1750     | 1830      |
| 170 DOUBLE RECLINING CHAIR RIGHT ARM   | 41x40x33/40   | 1990    | 2070                  | 2150   | 2230   | 2310                             | 2390                      | 1670   | 1750     | 1830      |
| 171 ARMLESS DOUBLE RECLINING CHAIR     | 30,5x40x33/40 | 1575    | 1625                  | 1675   | 1725   | 1775                             | 1825                      | 1320   | 1380     | 1440      |
| 173 DOUBLE LOUNGE CHAIR LEFT ARM       | 41x62x33/40   | 1915    | 2005                  | 2095   | 2185   | 2275                             | 2365                      | 1535   | 1615     | 1695      |
| 174 DOUBLE LOUNGE CHAIR RIGHT ARM      | 41x62x33/40   | 1915    | 2005                  | 2095   | 2185   | 2275                             | 2365                      | 1535   | 1615     | 1695      |
| 175 DOUBLE CHAIR LEFT ARM              | 41x40x33/40   | 1590    | 1680                  | 1770   | 1860   | 1950                             | 2040                      | 1285   | 1350     | 1415      |
| 176 DOUBLE CHAIR RIGHT ARM             | 41x40x33/40   | 1590    | 1680                  | 1770   | 1860   | 1950                             | 2040                      | 1285   | 1350     | 1415      |
| 177 ARMLESS DOUBLE CHAIR               | 30,5x40x33/40 | 1185    | 1250                  | 1315   | 1380   | 1445                             | 1510                      | 915    | 970      | 1025      |
| 178 ARMLESS DOUBLE CHAIR BUMPER LEFT   | 52x40x33/40   | 1545    | 1625                  | 1705   | 1785   | 1865                             | 1945                      | 1230   | 1290     | 1350      |



## MARSEILLE

### FEATURES:

- Manual adjustable headrest on all items (2 on square corner & stationary on wedge).
- \*Wall hugger power recliners with full footrest (manual n/a).
- Power recliner lounge chair (manual n/a) with power headrest in option. Wall clearance 8" & front 5".
- Seat cushions with shaped foam + 1" layer of memory foam on top; arm with memory foam.
- Stitching: Small thread in fabric & large flat thread in leather.
- \*Excludes 043 & 163 chairs: Wall clearance 16"

Note: 2 recliner seats separated by a corner can not be opened at the same time. No recliner seats beside item #155.

### OPTIONS

- Battery Pack: Add \$160/ea.
- \*Motorized headrest: Add \$160 ea. (\*N/A on stationary items).
- Foam: Extra firm add \$15/seat.
- Choice of Large or Small 6" Arm: Leg on LARGE arm: LG103 wood or LG189 metal (Black or Chrome). SMALL Arm: LG08 wood or Metal: LG196 cyl. (Black or Chrome) or LG64 (sq). Specify colour.
- Seat Depth: 20" or \*22". \*22" seat depth N/A on chairs 043 & 163.
- 043 & 163 Chairs: with wood base (specify colour).

### HOME THEATRE Configurations

For Accessories, Cup holders & Configuration details, see Optima Home Theatre page attached.

Accessory Dock : \$35 ea.

Cup Holders: Metal: \$25 ea. | LED lighted Cup Holder: \$25 ea. | \*LED lighted Cup Holder with (1 or 2 motor) controls: \$40 ea.

\*LED Light strip under seat: \$25/seat.

| Description                            | L x D x H       | Leather |                       |  |  |                                  |                           | Fabric |          |           |
|--|-----------------|---------|-----------------------|--|--|----------------------------------|---------------------------|--------|----------|-----------|
|  |                 | 10      | 20<br>Madras<br>Softy | 30<br>Hugo<br>Fantasy<br>Illusion<br>Tucson<br>Utah<br>Vintage<br>Wild Laredo<br>Yukon | 40<br>Elegance<br>Princess<br>Santiago<br>Sensation<br>Sunset<br>Trina<br>Victoria | 50<br>Bull<br>Cassiope<br>Dublin | 60<br>Caress<br>Ultrasued | A      | B<br>COM | C<br>alta |
| 179 ARMLESS DOUBLE CHAIR BUMPER RIGHT  | 52x40x33/40     | 1545    | 1625                  | 1705   | 1785   | 1865                             | 1945                      | 1230   | 1290     | 1350      |
| 186 ARMLESS LOVESEAT BUMPER STORAGE-L  | 68x40x33/40     | 2420    | 2500                  | 2580   | 2660   | 2740                             | 2820                      | 1950   | 2015     | 2080      |
| 187 ARMLESS LOVESEAT BUMPER STORAGE-R  | 68x40x33/40     | 2420    | 2500                  | 2580   | 2660   | 2740                             | 2820                      | 1950   | 2015     | 2080      |
| 188 ARMLESS CHAIR BUMPER STORAGE-L     | 45x40x33/40     | 1600    | 1690                  | 1780   | 1870   | 1960                             | 2050                      | 1295   | 1330     | 1365      |
| 189 ARMLESS CHAIR BUMPER STORAGE-R     | 45x40x33/40     | 1600    | 1690                  | 1780   | 1870   | 1960                             | 2050                      | 1295   | 1330     | 1365      |
| 190 SMALL WEDGE STORAGE                | 11/21x36x24     | 720     | 745                   | 770  | 795  | 820                              | 845                       | 550    | 570      | 590       |
| 221 ARMLESS DBL CHAIR BUMPER STORAGE-L | 52x40x33/40     | 1705    | 1790                  | 1875   | 1960   | 2045                             | 2130                      | 1390   | 1450     | 1510      |
| 222 ARMLESS DBL CHAIR BUMPER STORAGE-R | 52x40x33/40     | 1705    | 1790                  | 1875   | 1960   | 2045                             | 2130                      | 1390   | 1450     | 1510      |
| 223 APT SOFA NO ARM BUMPER STORAGE-L   | 82x40x33/40     | 2655    | 2785                  | 2915   | 3045   | 3175                             | 3305                      | 2120   | 2215     | 2310      |
| 224 APT SOFA NO ARM BUMPER STORAGE-R   | 82x40x33/40     | 2655    | 2785                  | 2915   | 3045   | 3175                             | 3305                      | 2120   | 2215     | 2310      |
| 236 RECLINING LOUNGE CHAIR LEFT ARM    | 34x62x33/40     | 2160    | 2225                  | 2290   | 2355   | 2420                             | 2485                      | 1820   | 1880     | 1940      |
| 237 RECLINING LOUNGE CHAIR RIGHT ARM   | 34x62x33/40     | 2160    | 2225                  | 2290   | 2355   | 2420                             | 2485                      | 1820   | 1880     | 1940      |
| 238 RECLINING DBL LOUNGE CHAIR L-ARM   | 41x62x33/40     | 2315    | 2405                  | 2495   | 2585   | 2675                             | 2765                      | 1940   | 2020     | 2100      |
| 239 RECLINING DBL LOUNGE CHAIR R-ARM   | 41x62x33/40     | 2315    | 2405                  | 2495   | 2585   | 2675                             | 2765                      | 1940   | 2020     | 2100      |
| V51 WINE GLASS HOLDER                  | 3.5 x 5.5 x 6.5 | 35      | 35                    | 35   | 35   | 35                               | 35                        | 35     | 35       | 35        |
| V52 PLASTIC SWIVEL TRAY                | 13 3/8 x 9 5/8  | 35      | 35                    | 35   | 35   | 35                               | 35                        | 35     | 35       | 35        |

## MARSEILLE

**FEATURES:**

- Manual adjustable headrest on all items (2 on square corner & stationary on wedge).
- \*Wall hugger power recliners with full footrest (manual n/a).
- Power recliner lounge chair (manual n/a) with power headrest in option. Wall clearance 8" & front 5".
- Seat cushions with shaped foam + 1" layer of memory foam on top; arm with memory foam.
- Stitching: Small thread in fabric & large flat thread in leather.
- \*Excludes 043 & 163 chairs: Wall clearance 16"

Note: 2 recliner seats separated by a corner can not be opened at the same time. No recliner seats beside item #155.

**OPTIONS**

- Battery Pack: Add \$160/ea.
- \*Motorized headrest: Add \$160 ea. (\*N/A on stationary items).
- Foam: Extra firm add \$15/seat.
- Choice of Large or Small 6" Arm: Leg on LARGE arm: LG103 wood or LG189 metal (Black or Chrome). SMALL Arm: LG08 wood or Metal: LG196 cyl. (Black or Chrome) or LG64 (sq). Specify colour.
- Seat Depth: 20" or \*22". \*22" seat depth N/A on chairs 043 & 163.
- 043 & 163 Chairs: with wood base (specify colour).

**HOME THEATRE Configurations**

For Accessories, Cup holders & Configuration details, see Optima Home Theatre page attached.

Accessory Dock : \$35 ea.

Cup Holders: Metal: \$25 ea. | LED lighted Cup Holder: \$25 ea. | \*LED lighted Cup Holder with (1 or 2 motor) controls: \$40 ea.

\*LED Light strip under seat: \$25/seat.

| Description                 | L x D x H          | Leather |                       |  |  |                                  |                           | Fabric |          |           |
|-----------------------------|--------------------|---------|-----------------------|--|--|----------------------------------|---------------------------|--------|----------|-----------|
|                             |                    | 10      | 20<br>Madras<br>Softy | 30<br>Hugo<br>Fantasy<br>Illusion<br>Tucson<br>Utah<br>Vintage<br>Wild Laredo<br>Yukon | 40<br>Elegance<br>Princess<br>Santiago<br>Sensation<br>Sunset<br>Trina<br>Victoria | 50<br>Bull<br>Cassiope<br>Dublin | 60<br>Caress<br>Ultrasued | A      | B<br>COM | C<br>alta |
| V53 WOOD SWIVEL TRAY        | 19 x 10            | 60      | 60                    | 60   | 60   | 60                               | 60                        | 60     | 60       | 60        |
| V54 TABLET HOLDER           | 4.5 x 8 x 10       | 40      | 40                    | 40   | 40   | 40                               | 40                        | 40     | 40       | 40        |
| V55 LED LAMP                | 1.5x5x14 plié/bent | 35      | 35                    | 35   | 35   | 35                               | 35                        | 35     | 35       | 35        |
| <b>CONFIGURATIONS</b>       |                    |         |                       |  |  |                                  |                           |        |          |           |
| _A CONFIG (169-170)         | 82X40X40           | 3980    | 4140                  | 4300   | 4460   | 4620                             | 4780                      | 3340   | 3500     | 3660      |
| _B CONFIG (169-171-174)     | 113X62X40          | 5480    | 5700                  | 5920   | 6140   | 6360                             | 6580                      | 4525   | 4745     | 4965      |
| _C CONFIG (096-055-171-170) | 115X115X40         | 8050    | 8385                  | 8720   | 9055   | 9390                             | 9725                      | 6520   | 6805     | 7090      |
| _D CONFIG (169-171-055-179) | 115X96X40          | 7025    | 7330                  | 7635   | 7940   | 8245                             | 8550                      | 5730   | 5985     | 6240      |
| _J CONFIG (041-042)         | 68X40X40           | 3770    | 3920                  | 4070   | 4220   | 4370                             | 4520                      | 3210   | 3280     | 3350      |
| _K CONFIG (041-071-005)     | 92X62X40           | 5120    | 5315                  | 5510   | 5705   | 5900                             | 6095                      | 4265   | 4420     | 4575      |
| _L CONFIG (012-055-071-042) | 102X102X40         | 7590    | 7915                  | 8240   | 8565   | 8890                             | 9215                      | 6215   | 6440     | 6665      |
| _M CONFIG (041-071-055-089) | 102X89X40          | 6710    | 7030                  | 7350   | 7670   | 7990                             | 8310                      | 5495   | 5680     | 5865      |



# MARSEILLE

**OPTIMA**  
Collection

**Jaymar**

Conçu et fabriqué fièrement au Canada  
Proudly designed and made in Canada

Nos produits sont fabriqués à la main et des variations mineures peuvent survenir.

Our product is hand-made and minor variations can occur.

## SPECIFICATIONS

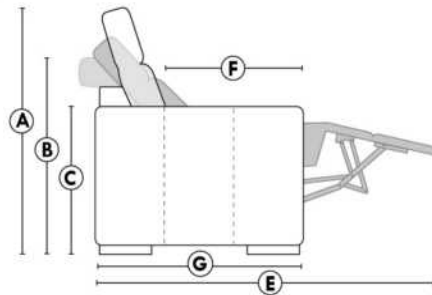

- Appui-tête levé Headrest up
- Appui-tête baissé Headrest down
- Complètement incliné Fully reclined

- A** Hauteur complète 40" Total Height
- B** Hauteur appui-tête baissé 33" Height headrest down
- C** Hauteur du bras 24" Arm Height
- D** Hauteur du siège 19,5" Seat height
- E** Profondeur inclinée 65" Depth fully reclined
- F** Profondeur d'assise 20"ou/ou 22" Seat depth
- G** Profondeur appui-tête monté 37,5" Depth with headrest up

## BRAS | ARMS

Option de bras:  
Bras Régulier Large 10" ou Petit bras 6"

Arm option  
Regular arm Large 10" or Small arm 6"

Contrôle de l'inclinaison situé à l'intérieur du bras  
Recliner control located on the inside of the arm.

Option d'accessoires disponible sur le bras régulier seulement  
Accessories option, available on Regular arms ONLY.

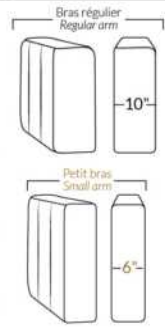

## FAUTEUIL BERÇANT PIVOTANT INCLINABLE SWIVEL ROCKING MOTION CHAIR

Dégagement mural de 16" Wall clearance  
Hauteur de 42" Height  
Largeur de bras 6" Arms width  
Option base de bois | Wood base option

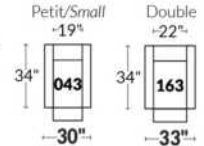

## SIÈGE 23" DE LARGE | 23" SEAT WIDTH

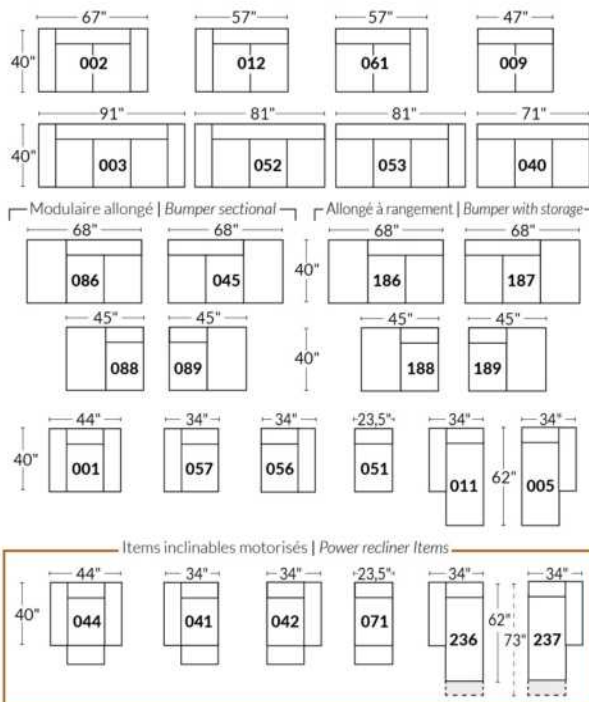

## SIÈGE 30" DE LARGE | 30" SEAT WIDTH

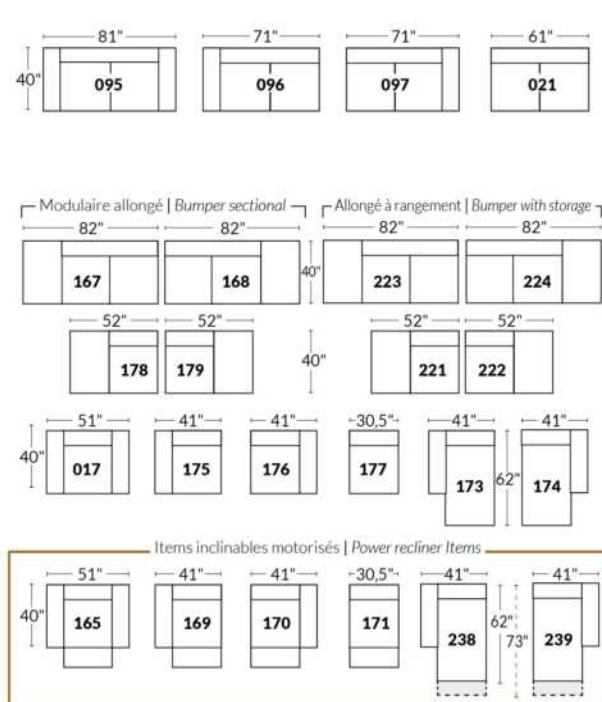

### Autres | Others

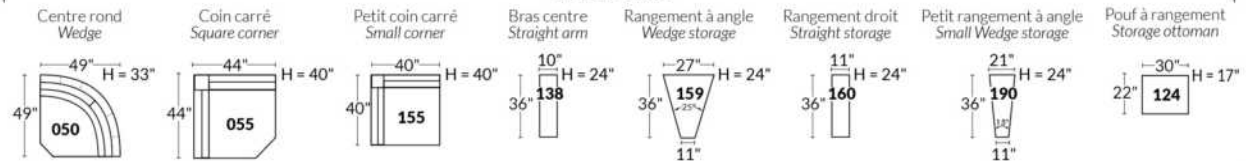

### EXEMPLE 23" EXAMPLE

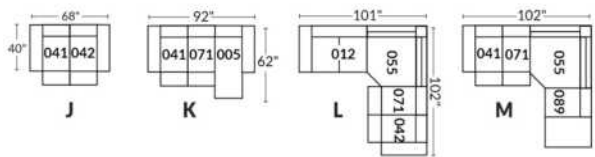

### EXEMPLE 30" EXAMPLE

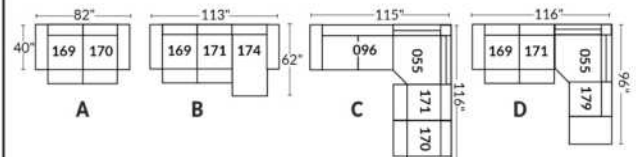

\*Available on certain models and on large arms ONLY.

### OPTIONS CUP HOLDERS

#### METAL



Silver



Matte Black



Brown

#### ILLUMINATED

1.



LED Lighted Cup holder

2.



LED Lighted Cup holder with Single Motor Control, USB Port and LED Base rail

3.



LED Lighted Cup holder with Dual Motor Control, USB Port and LED Base rail

Our illuminated one or two-control cup holders are compatible with LED lights under the seat. You can control the light on the cup holder. The 2 motor cup holder has a reset (home) button control to close your recliner back to its starting position.

#### LED Light under seat (Optional)

Available only in configurations with a minimum of 1 illuminated motorized cup holder with control buttons. The "light" button will control the opening and closing of the light.

For cup holder prices see description section of the Optima model price list.

Please provide us with a drawing of your configuration which indicates the cup holder type and its positioning.

#### Cup holder with controller:

It is important to specify the placement of the cups; on left arm or right arm and which recliner they will control. If you have a row of several seats with cup holders, by default, the controls will be on the left arms and on the right arm for the last outer chair.

#### EXAMPLE A:

041-169: Controller and cup holder on the left arm

071-171: hidden touch sensor buttons on side of seat

042-170: Controller and cup holder on right arm



#### EXAMPLE B:

071-171: These two items can be connected to a smart cup holder which will control the recliner. You must then use one of these items: 138, 159, 160 and 190



#### Informations about headrest, controller on reclining seat

#### WITH illuminated cup holder

If you have a **stationary item**, you will have cup holder N°1.

If you have a recliner chair with a **manual headrest**, you will have the cup holder N°2.

If you have a recliner chair with an **electric headrest**, you will have cup holder N°3.

#### Without cup holder and with a reclining seat

If you have a recliner with a **manual headrest** you will have the touch sensor button control on the side of the seat.

If you have a recliner with an **electric headrest** you will have a dual push button controller with USB port on the arm.

If you have an **armless recliner**, you will have the hidden touch sensor button control.



Hidden touch sensor



Dual push button

# OPTIMA

## HOME THEATRE Configurations

\*Available on certain models and on large arms ONLY.

OPTIONS

### ACCESSORIES

Accessory Dock



V51 Wine Glass Holder



V52 Plastic Swivel Tray Table



V53 Wood Swivel tray Table  
(Choice of 8 colors)



Specify on which arm (left or right) the tray table will be installed.

V54 Tablet Holder



V55 LED Lamp



(For Accessory Dock price, see description section of the Optima model price list and for Accessory item prices, see at very end of the price list)

#### Items 138-159-160-190 and large arm.

Accessory docks and cups are Optional. \*Not available on small arms\*

Please specify on which arms you want the accessory docks and cup holders.

NB: Item 138-159-160-190 are unfinished on the sides, must be used between 2 seats.

Each storage item has 2 USB ports and one electrical outlet inside the storage.



#### SUGGESTED CONFIGURATIONS





## MAXIMA

Features: Manual adjustable headrest included with all items (2 on square corner). Stitching: Small thread in fabric & large flat thread in leather.  
Memory foam in seat cushions.  
NOTE: 2 recliner seats SEPARATED by a SQUARE CORNER or TABLE cannot be opened at the same time.

OPTIONS - Provide SKETCH of your config:

Small 6" Arm: at same price.

Leg (specify colour): On LARGE arm: LG189 metal (Black or Chrome) or LG187 wood. On SMALL arm: LG64 metal or LG08 wood.

Table (#154): Specify colour of wood table top.

043 & 163 Chairs: with wood base (specify colour).

Accessories: Anchorage \$35 ea. | Plastic Swivel tray & Wine Glass holder \$35 ea. | Wood Swivel tray \$60 ea. | Tablet holder \$40 ea. & LED Lamp \$35 ea.

\*\*MANUAL RECLINER N/A.\*\* Motorized mechanism included in price of recliner chair items. For Battery Pack add \$160/mechanism.

| Description                        | L x D x H     | Leather |                       |  |  |                                  |                           | Fabric |          |           |
|------------------------------------|---------------|---------|-----------------------|--|--|----------------------------------|---------------------------|--------|----------|-----------|
|                                    |               | 10      | 20<br>Madras<br>Softy | 30<br>Hugo<br>Fantasy<br>Illusion<br>Tucson<br>Utah<br>Vintage<br>Wild Laredo<br>Yukon | 40<br>Elegance<br>Princess<br>Santiago<br>Sensation<br>Sunset<br>Trina<br>Victoria | 50<br>Bull<br>Cassiope<br>Dublin | 60<br>Caress<br>Ultrasued | A      | B<br>COM | C<br>alta |
| 001 CHAIR                          | 45x40x30/39   | 1765    | 1855                  | 1945   | 2035   | 2125                             | 2215                      | 1330   | 1365     | 1400      |
| 002 LOVESEAT                       | 68x40x30/39   | 2535    | 2665                  | 2795   | 2925   | 3055                             | 3185                      | 1945   | 2010     | 2075      |
| 003 SOFA                           | 92x40x30/39   | 3100    | 3250                  | 3400   | 3550   | 3700                             | 3850                      | 2365   | 2465     | 2565      |
| 005 LOUNGE CHAIR RIGHT ARM         | 35x62x30/39   | 1630    | 1705                  | 1780   | 1855   | 1930                             | 2005                      | 1235   | 1310     | 1385      |
| 009 ARMLESS LOVESEAT               | 47x40x30/39   | 1855    | 1935                  | 2015   | 2095   | 2175                             | 2255                      | 1410   | 1485     | 1560      |
| 011 LOUNGE CHAIR LEFT ARM          | 35x62x30/39   | 1630    | 1705                  | 1780   | 1855   | 1930                             | 2005                      | 1235   | 1310     | 1385      |
| 012 LOVESEAT LEFT ARM              | 58x40x30/39   | 2200    | 2305                  | 2410   | 2515   | 2620                             | 2725                      | 1660   | 1735     | 1810      |
| 017 DOUBLE CHAIR                   | 52x40x30/39   | 1865    | 1970                  | 2075   | 2180   | 2285                             | 2390                      | 1410   | 1480     | 1550      |
| 021 APARTMENT SOFA NO ARM          | 61x40x30/39   | 2085    | 2175                  | 2265   | 2355   | 2445                             | 2535                      | 1605   | 1675     | 1745      |
| 040 ARMLESS SOFA                   | 71x40x30/39   | 2420    | 2500                  | 2580   | 2660   | 2740                             | 2820                      | 1825   | 1930     | 2035      |
| 041 RECLINING CHAIR LEFT ARM       | 35x40x30/39   | 1775    | 1835                  | 1895   | 1955   | 2015                             | 2075                      | 1450   | 1505     | 1560      |
| 042 RECLINING CHAIR RIGHT ARM      | 35x40x30/39   | 1775    | 1835                  | 1895   | 1955   | 2015                             | 2075                      | 1450   | 1505     | 1560      |
| 043 SWIVEL ROCKING RECLINING CHAIR | 30 x 34 x 42  | 2150    | 2245                  | 2340   | 2435   | 2530                             | 2625                      | 1790   | 1835     | 1880      |
| 044 RECLINER CHAIR                 | 45x40x30/39   | 2115    | 2215                  | 2315   | 2415   | 2515                             | 2615                      | 1705   | 1760     | 1815      |
| 045 ARMLESS LOVESEAT BUMPER RIGHT  | 68x40x30/39   | 2175    | 2290                  | 2405   | 2520   | 2635                             | 2750                      | 1645   | 1720     | 1795      |
| 051 ARMLESS CHAIR                  | 23,5x40x30/39 | 1065    | 1115                  | 1165   | 1215   | 1265                             | 1315                      | 800    | 865      | 930       |
| 052 SOFA LEFT ARM                  | 82x40x30/39   | 2750    | 2885                  | 3020   | 3155   | 3290                             | 3425                      | 2095   | 2190     | 2285      |
| 053 SOFA RIGHT ARM                 | 82x40x30/39   | 2750    | 2885                  | 3020   | 3155   | 3290                             | 3425                      | 2095   | 2190     | 2285      |
| 055 SQUARE CORNER                  | 44x44x30/39   | 1920    | 2010                  | 2100   | 2190   | 2280                             | 2370                      | 1480   | 1530     | 1580      |
| 056 CHAIR RIGHT ARM                | 35x40x30/39   | 1405    | 1480                  | 1555   | 1630   | 1705                             | 1780                      | 1080   | 1130     | 1180      |
| 057 CHAIR LEFT ARM                 | 35x40x30/39   | 1405    | 1480                  | 1555   | 1630   | 1705                             | 1780                      | 1080   | 1130     | 1180      |
| 061 LOVESEAT RIGHT ARM             | 58x40x30/39   | 2200    | 2305                  | 2410   | 2515   | 2620                             | 2725                      | 1660   | 1735     | 1810      |





## MAXIMA

Features: Manual adjustable headrest included with all items (2 on square corner). Stitching: Small thread in fabric & large flat thread in leather.  
Memory foam in seat cushions.  
NOTE: 2 recliner seats SEPARATED by a SQUARE CORNER or TABLE cannot be opened at the same time.

OPTIONS - Provide SKETCH of your config:

Small 6" Arm: at same price.

Leg (specify colour): On LARGE arm: LG189 metal (Black or Chrome) or LG187 wood. On SMALL arm: LG64 metal or LG08 wood.

Table (#154): Specify colour of wood table top.

043 & 163 Chairs: with wood base (specify colour).

Accessories: Anchorage \$35 ea. | Plastic Swivel tray & Wine Glass holder \$35 ea. | Wood Swivel tray \$60 ea. | Tablet holder \$40 ea. & LED Lamp \$35 ea.

\*\*MANUAL RECLINER N/A.\*\* Motorized mechanism included in price of recliner chair items. For Battery Pack add \$160/mechanism.

| Description                            | L x D x H     | Leather |                       |  |  |                                  |                           | Fabric |          |           |
|--|---------------|---------|-----------------------|--|--|----------------------------------|---------------------------|--------|----------|-----------|
|  |               | 10      | 20<br>Madras<br>Softy | 30<br>Hugo<br>Fantasy<br>Illusion<br>Tucson<br>Utah<br>Vintage<br>Wild Laredo<br>Yukon | 40<br>Elegance<br>Princess<br>Santiago<br>Sensation<br>Sunset<br>Trina<br>Victoria | 50<br>Bull<br>Cassiope<br>Dublin | 60<br>Caress<br>Ultrasued | A      | B<br>COM | C<br>alta |
| 071 ARMLESS RECLINING CHAIR            | 23,5x40x30/39 | 1420    | 1485                  | 1550   | 1615   | 1680                             | 1745                      | 1185   | 1230     | 1275      |
| 086 ARMLESS LOVESEAT BUMPER LEFT       | 68x40x30/39   | 2175    | 2290                  | 2405   | 2520   | 2635                             | 2750                      | 1645   | 1720     | 1795      |
| 088 ARMLESS CHAIR BUMPER LEFT          | 45x40x30/39   | 1365    | 1455                  | 1545   | 1635   | 1725                             | 1815                      | 1045   | 1095     | 1145      |
| 089 ARMLESS CHAIR BUMPER RIGHT         | 45x40x30/39   | 1365    | 1455                  | 1545   | 1635   | 1725                             | 1815                      | 1045   | 1095     | 1145      |
| 095 APARTMENT SOFA                     | 82x40x30/39   | 2795    | 2930                  | 3065   | 3200   | 3335                             | 3470                      | 2120   | 2205     | 2290      |
| 096 APARTMENT SOFA LEFT ARM            | 72x40x30/39   | 2445    | 2580                  | 2715   | 2850   | 2985                             | 3120                      | 1850   | 1945     | 2040      |
| 097 APARTMENT SOFA RIGHT ARM           | 72x40x30/39   | 2445    | 2580                  | 2715   | 2850   | 2985                             | 3120                      | 1850   | 1945     | 2040      |
| 124 STORAGE OTTOMAN                    | 30x22x17      | 705     | 730                   | 755  | 780  | 805                              | 830                       | 605    | 615      | 625       |
| 154 UPHOLSTERED ANGULAR TABLE          | 7/34x32.5x19  | 600     | 625                   | 650  | 675  | 700                              | 725                       | 515    | 530      | 545       |
| 163 DBL SWIVEL ROCKING RECLINER CHAIR  | 33 x 34 x 42  | 2200    | 2315                  | 2430   | 2545   | 2660                             | 2775                      | 1795   | 1840     | 1885      |
| 165 DOUBLE RECLINING CHAIR             | 52x40x30/39   | 2235    | 2335                  | 2435   | 2535   | 2635                             | 2735                      | 1795   | 1850     | 1905      |
| 167 APARTMENT SOFA NO ARM BUMPER LEFT  | 82x40x30/39   | 2425    | 2560                  | 2695   | 2830   | 2965                             | 3100                      | 1830   | 1930     | 2030      |
| 168 APARTMENT SOFA NO ARM BUMPER RIGHT | 82x40x30/39   | 2425    | 2560                  | 2695   | 2830   | 2965                             | 3100                      | 1830   | 1930     | 2030      |
| 169 DOUBLE RECLINING CHAIR LEFT ARM    | 42x40x30/39   | 1880    | 1955                  | 2030   | 2105   | 2180                             | 2255                      | 1525   | 1580     | 1635      |
| 170 DOUBLE RECLINING CHAIR RIGHT ARM   | 42x40x30/39   | 1880    | 1955                  | 2030   | 2105   | 2180                             | 2255                      | 1525   | 1580     | 1635      |
| 171 ARMLESS DOUBLE RECLINING CHAIR     | 30,5x40x30/39 | 1530    | 1600                  | 1670   | 1740   | 1810                             | 1880                      | 1245   | 1310     | 1375      |
| 173 DOUBLE LOUNGE CHAIR LEFT ARM       | 42x62x30/39   | 1775    | 1870                  | 1965   | 2060   | 2155                             | 2250                      | 1340   | 1420     | 1500      |
| 174 DOUBLE LOUNGE CHAIR RIGHT ARM      | 42x62x30/39   | 1775    | 1870                  | 1965   | 2060   | 2155                             | 2250                      | 1340   | 1420     | 1500      |
| 175 DOUBLE CHAIR LEFT ARM              | 42x40x30/39   | 1510    | 1590                  | 1670   | 1750   | 1830                             | 1910                      | 1145   | 1215     | 1285      |
| 176 DOUBLE CHAIR RIGHT ARM             | 42x40x30/39   | 1510    | 1590                  | 1670   | 1750   | 1830                             | 1910                      | 1145   | 1215     | 1285      |
| 177 ARMLESS DOUBLE CHAIR               | 30,5x40x30/39 | 1155    | 1230                  | 1305   | 1380   | 1455                             | 1530                      | 890    | 945      | 1000      |
| 178 ARMLESS DOUBLE CHAIR BUMPER LEFT   | 52x40x30/39   | 1470    | 1565                  | 1660   | 1755   | 1850                             | 1945                      | 1135   | 1195     | 1255      |



## MAXIMA

Features: Manual adjustable headrest included with all items (2 on square corner). Stitching: Small thread in fabric & large flat thread in leather.  
Memory foam in seat cushions.  
NOTE: 2 recliner seats SEPARATED by a SQUARE CORNER or TABLE cannot be opened at the same time.

OPTIONS - Provide SKETCH of your config:

Small 6" Arm: at same price.

Leg (specify colour): On LARGE arm: LG189 metal (Black or Chrome) or LG187 wood. On SMALL arm: LG64 metal or LG08 wood.

Table (#154): Specify colour of wood table top.

043 & 163 Chairs: with wood base (specify colour).

Accessories: Anchorage \$35 ea. | Plastic Swivel tray & Wine Glass holder \$35 ea. | Wood Swivel tray \$60 ea. | Tablet holder \$40 ea. & LED Lamp \$35 ea.

\*\*MANUAL RECLINER N/A.\*\* Motorized mechanism included in price of recliner chair items. For Battery Pack add \$160/mechanism.

| Description                           | L x D x H     | Leather |                       |  |  |                                  |                           | Fabric |          |           |
|---------------------------------------|---------------|---------|-----------------------|--|--|----------------------------------|---------------------------|--------|----------|-----------|
|                                       |               | 10      | 20<br>Madras<br>Softy | 30<br>Hugo<br>Fantasy<br>Illusion<br>Tucson<br>Utah<br>Vintage<br>Wild Laredo<br>Yukon | 40<br>Elegance<br>Princess<br>Santiago<br>Sensation<br>Sunset<br>Trina<br>Victoria | 50<br>Bull<br>Cassiope<br>Dublin | 60<br>Caress<br>Ultrasued | A      | B<br>COM | C<br>alta |
| 179 ARMLESS DOUBLE CHAIR BUMPER RIGHT | 52x40x30/39   | 1470    | 1565                  | 1660   | 1755   | 1850                             | 1945                      | 1135   | 1195     | 1255      |
| <b>CONFIGURATIONS</b>                 |               |         |                       |  |  |                                  |                           |        |          |           |
| A CONFIG (169-170)                    | 84X40X30/39   | 3760    | 3910                  | 4060   | 4210   | 4360                             | 4510                      | 3050   | 3160     | 3270      |
| B CONFIG (169-171-174)                | 115X62X30/39  | 5185    | 5425                  | 5665   | 5905   | 6145                             | 6385                      | 4110   | 4310     | 4510      |
| C CONFIG (096-055-171-170)            | 116X117X30/39 | 7775    | 8145                  | 8515   | 8885   | 9255                             | 9625                      | 6100   | 6365     | 6630      |
| D CONFIG (169-171-055-179)            | 117X96X30/39  | 6800    | 7130                  | 7460   | 7790   | 8120                             | 8450                      | 5385   | 5615     | 5845      |
| J CONFIG (041-042)                    | 70X40X30/39   | 3550    | 3670                  | 3790   | 3910   | 4030                             | 4150                      | 2900   | 3010     | 3120      |
| K CONFIG (041-071-005)                | 94X62X30/39   | 4825    | 5025                  | 5225   | 5425   | 5625                             | 5825                      | 3870   | 4045     | 4220      |
| L CONFIG (012-055-071-042)            | 102X103X30/39 | 7315    | 7635                  | 7955   | 8275   | 8595                             | 8915                      | 5775   | 6000     | 6225      |
| M CONFIG (041-071-055-089)            | 103X89X30/39  | 6480    | 6785                  | 7090   | 7395   | 7700                             | 8005                      | 5160   | 5360     | 5560      |





# MAXIMA

LINEA 30 Collection



Conçu et fabriqué fièrement au Canada  
Proudly designed and made in Canada

Nos produits sont fabriqués à la main et des variations mineures peuvent survenir

Our product is hand-made and minor variations can occur.

## SPECIFICATIONS

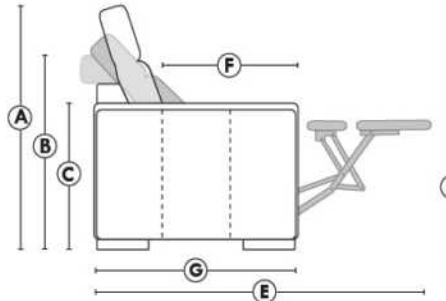

- Appui-tête levé Headrest up
- Appui-tête baissé Headrest down
- Complètement incliné Fully reclined

- A** Hauteur complète 39" Total Height
- B** Hauteur appui-tête baissé 30" Height headrest down
- C** Hauteur du bras 24" Arm Height
- D** Hauteur du siège 19,5" Seat height
- E** Profondeur inclinée 63" Depth fully reclined
- F** Profondeur d'assise 20" Seat depth
- G** Profondeur appui-tête monté 37,5" Depth with headrest up

## BRAS | ARMS

Option de bras:  
Bras Régulier Large 10,5" ou Petit bras 6"

Arm option  
Regular arm Large 10.5" or Small arm 6"

Contrôle de l'inclinaison situé à l'intérieur du bras  
Recliner control located on the inside of the arm.

Option d'accessoires disponible sur le bras régulier seulement  
Accessories option, available on Regular arms ONLY.

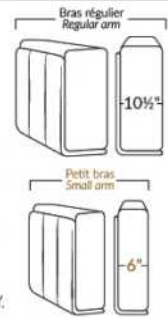

## FAUTEUIL BERÇANT PIVOTANT INCLINABLE SWIVEL ROCKING MOTION CHAIR

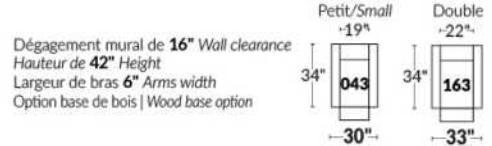

## SIÈGE 23" DE LARGE | 23" SEAT WIDTH

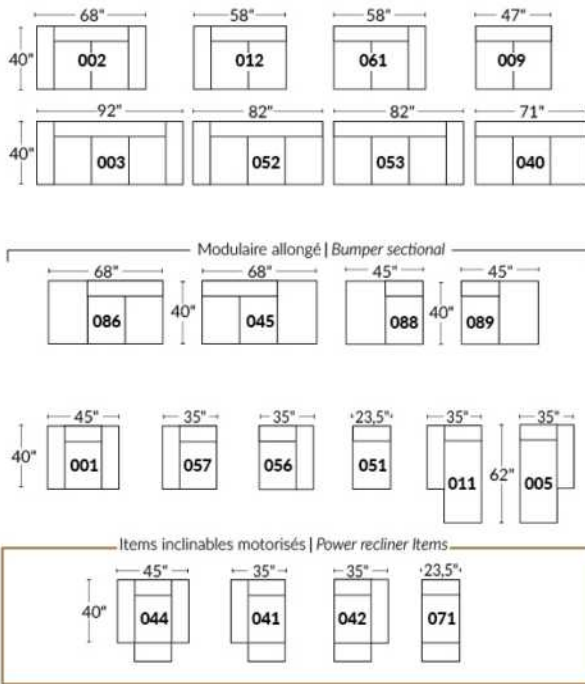

## SIÈGE 30" DE LARGE | 30" SEAT WIDTH

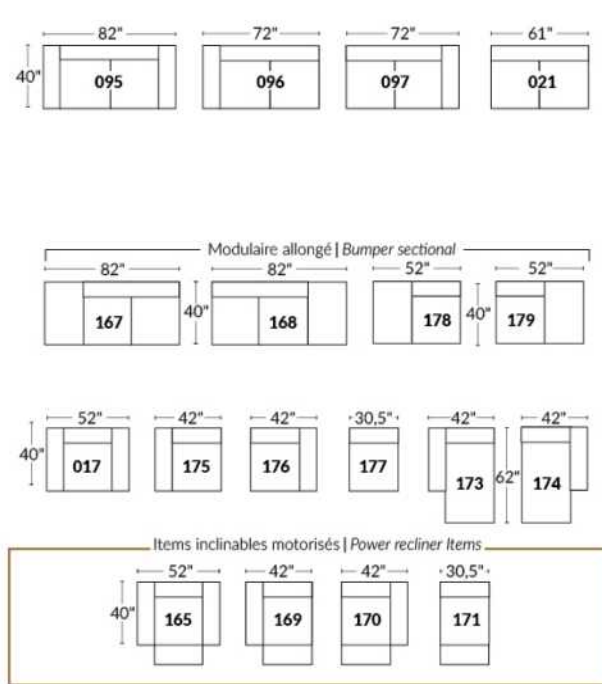

### Autres | Others

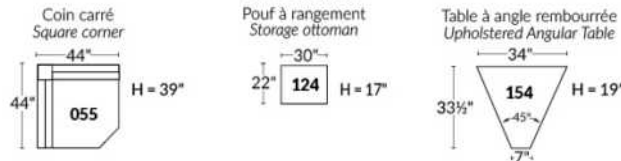

## EXEMPLE 23" EXAMPLE

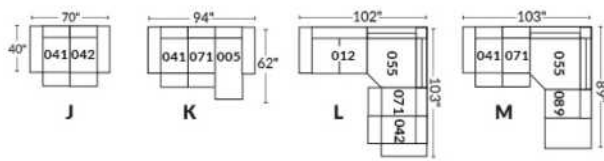

## EXEMPLE 30" EXAMPLE

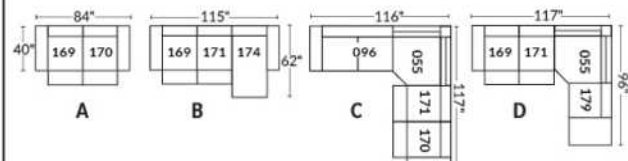

## MELBOURNE

- Manual adjustable headrest on all items (2 on square corner & stationary on wedge).
- \*Wall hugger power recliners with full footrest (manual n/a).
- Power recliner lounge chair (manual n/a) with power headrest in option. Wall clearance 8" & front 5".
- Seat cushions with shaped foam + 1" layer of memory foam on top; arm with memory foam.
- Stitching: Small thread in fabric & large flat thread in leather.
- \*Excludes 043 & 163 chairs: Wall clearance 16"

Note: 2 recliner seats separated by a corner can not be opened at the same time. No recliner seats beside #155 Small Square Corner.

### OPTIONS

Battery Pack: Add \$160/ea.

\*Motorized headrest: Add \$160 ea. (\*N/A on stationary items).

Foam: Extra firm add \$15/seat.

Choice of with or without "Wood Insert" in arm. If with wood insert, specify colour.

Choice of Large or Small 6" Arm: Leg on LARGE arm: LG103 wood or LG189 metal (Black or Chrome). SMALL Arm: LG08 wood or LG196 metal (Black or Chrome). Specify colour.

Seat Depth: 20" or \*22". \*22" seat depth N/A on chairs 043 & 163.

-043 & 163 Chairs: with wood base (specify colour).

### HOME THEATRE Configurations

For Accessories, Cup holders & Configuration details, see Optima Home Theatre page attached.

Accessory Dock : \$35 ea.

Cup Holders: Metal: \$25 ea. | LED lighted Cup Holder: \$25 ea. | \*LED lighted Cup Holder with (1 or 2 motor) controls: \$40 ea.

\*LED Light strip under seat: \$25/seat.

| Description                        | L x D x H   | Leather |                       |  |  |                                  |                            | Fabric |          |           |
|------------------------------------|-------------|---------|-----------------------|--|--|----------------------------------|----------------------------|--------|----------|-----------|
|                                    |             | 10      | 20<br>Madras<br>Softy | 30<br>Hugo<br>Fantasy<br>Illusion<br>Tucson<br>Utah<br>Vintage<br>Wild Laredo<br>Yukon | 40<br>Elegance<br>Princess<br>Santiago<br>Sensation<br>Sunset<br>Trina<br>Victoria | 50<br>Bull<br>Cassiope<br>Dublin | 60<br>Caresse<br>Ultrasued | A      | B<br>COM | C<br>alta |
| 001 CHAIR                          | 44x40x33/40 | 1890    | 1980                  | 2070   | 2160   | 2250                             | 2340                       | 1535   | 1580     | 1625      |
| 002 LOVESEAT                       | 67x40x33/40 | 2700    | 2815                  | 2930   | 3045   | 3160                             | 3275                       | 2175   | 2250     | 2325      |
| 003 SOFA                           | 91x40x33/40 | 3265    | 3415                  | 3565   | 3715   | 3865                             | 4015                       | 2625   | 2715     | 2805      |
| 005 LOUNGE CHAIR RIGHT ARM         | 34x62x33/40 | 1765    | 1830                  | 1895   | 1960   | 2025                             | 2090                       | 1410   | 1470     | 1530      |
| 009 ARMLESS LOVESEAT               | 47x40x33/40 | 1895    | 1965                  | 2035   | 2105   | 2175                             | 2245                       | 1490   | 1570     | 1650      |
| 011 LOUNGE CHAIR LEFT ARM          | 34x62x33/40 | 1765    | 1830                  | 1895   | 1960   | 2025                             | 2090                       | 1410   | 1470     | 1530      |
| 012 LOVESEAT LEFT ARM              | 57x40x33/40 | 2320    | 2420                  | 2520   | 2620   | 2720                             | 2820                       | 1850   | 1925     | 2000      |
| 017 DOUBLE CHAIR                   | 51x40x33/40 | 1980    | 2080                  | 2180   | 2280   | 2380                             | 2480                       | 1600   | 1660     | 1720      |
| 021 APARTMENT SOFA NO ARM          | 61x40x33/40 | 2140    | 2240                  | 2340   | 2440   | 2540                             | 2640                       | 1670   | 1755     | 1840      |
| 040 ARMLESS SOFA                   | 71x40x33/40 | 2450    | 2565                  | 2680   | 2795   | 2910                             | 3025                       | 1950   | 2040     | 2130      |
| 041 RECLINING CHAIR LEFT ARM       | 34x40x33/40 | 1885    | 1960                  | 2035   | 2110   | 2185                             | 2260                       | 1605   | 1640     | 1675      |
| 042 RECLINING CHAIR RIGHT ARM      | 34x40x33/40 | 1885    | 1960                  | 2035   | 2110   | 2185                             | 2260                       | 1605   | 1640     | 1675      |
| 043 SWIVEL ROCKING RECLINING CHAIR | 30x34x42    | 2235    | 2345                  | 2455   | 2565   | 2675                             | 2785                       | 1875   | 1920     | 1965      |
| 044 RECLINER CHAIR                 | 44x40x33/40 | 2275    | 2365                  | 2455   | 2545   | 2635                             | 2725                       | 1920   | 1970     | 2020      |
| 045 ARMLESS LOVESEAT BUMPER RIGHT  | 68x40x33/40 | 2245    | 2340                  | 2435   | 2530   | 2625                             | 2720                       | 1785   | 1850     | 1915      |
| 050 WEDGE                          | 49x49x33    | 1645    | 1745                  | 1845   | 1945   | 2045                             | 2145                       | 1210   | 1270     | 1330      |

## MELBOURNE

- Manual adjustable headrest on all items (2 on square corner & stationary on wedge).
- \*Wall hugger power recliners with full footrest (manual n/a).
- Power recliner lounge chair (manual n/a) with power headrest in option. Wall clearance 8" & front 5".
- Seat cushions with shaped foam + 1" layer of memory foam on top; arm with memory foam.
- Stitching: Small thread in fabric & large flat thread in leather.
- \*Excludes 043 & 163 chairs: Wall clearance 16"

Note: 2 recliner seats separated by a corner can not be opened at the same time. No recliner seats beside #155 Small Square Corner.

### OPTIONS

Battery Pack: Add \$160/ea.

\*Motorized headrest: Add \$160 ea. (\*N/A on stationary items).

Foam: Extra firm add \$15/seat.

Choice of with or without "Wood Insert" in arm. If with wood insert, specify colour.

Choice of Large or Small 6" Arm: Leg on LARGE arm: LG103 wood or LG189 metal (Black or Chrome). SMALL Arm: LG08 wood or LG196 metal (Black or Chrome). Specify colour.

Seat Depth: 20" or \*22". \*22" seat depth N/A on chairs 043 & 163.

-043 & 163 Chairs: with wood base (specify colour).

### HOME THEATRE Configurations

For Accessories, Cup holders & Configuration details, see Optima Home Theatre page attached.

Accessory Dock : \$35 ea.

Cup Holders: Metal: \$25 ea. | LED lighted Cup Holder: \$25 ea. | \*LED lighted Cup Holder with (1 or 2 motor) controls: \$40 ea.

\*LED Light strip under seat: \$25/seat.

| Description                      | L x D x H     | Leather |                       |  |  |                                  |                            | Fabric |          |           |
|----------------------------------|---------------|---------|-----------------------|--|--|----------------------------------|----------------------------|--------|----------|-----------|
|                                  |               | 10      | 20<br>Madras<br>Softy | 30<br>Hugo<br>Fantasy<br>Illusion<br>Tucson<br>Utah<br>Vintage<br>Wild Laredo<br>Yukon | 40<br>Elegance<br>Princess<br>Santiago<br>Sensation<br>Sunset<br>Trina<br>Victoria | 50<br>Bull<br>Cassiope<br>Dublin | 60<br>Caresse<br>Ultrasued | A      | B<br>COM | C<br>alta |
| 051 ARMLESS CHAIR                | 23,5x40x33/40 | 1085    | 1135                  | 1185   | 1235   | 1285                             | 1335                       | 845    | 900      | 955       |
| 052 SOFA LEFT ARM                | 81x40x33/40   | 2870    | 3005                  | 3140   | 3275   | 3410                             | 3545                       | 2290   | 2385     | 2480      |
| 053 SOFA RIGHT ARM               | 81x40x33/40   | 2870    | 3005                  | 3140   | 3275   | 3410                             | 3545                       | 2290   | 2385     | 2480      |
| 055 SQUARE CORNER                | 44x44x33/40   | 1915    | 2010                  | 2105   | 2200   | 2295                             | 2390                       | 1510   | 1565     | 1620      |
| 056 CHAIR RIGHT ARM              | 34x40x33/40   | 1510    | 1575                  | 1640   | 1705   | 1770                             | 1835                       | 1200   | 1260     | 1320      |
| 057 CHAIR LEFT ARM               | 34x40x33/40   | 1510    | 1575                  | 1640   | 1705   | 1770                             | 1835                       | 1200   | 1260     | 1320      |
| 061 LOVESEAT RIGHT ARM           | 57x40x33/40   | 2320    | 2420                  | 2520   | 2620   | 2720                             | 2820                       | 1850   | 1925     | 2000      |
| 071 ARMLESS RECLINING CHAIR      | 23,5x40x33/40 | 1470    | 1525                  | 1580   | 1635   | 1690                             | 1745                       | 1250   | 1310     | 1370      |
| 086 ARMLESS LOVESEAT BUMPER LEFT | 68x40x33/40   | 2245    | 2340                  | 2435   | 2530   | 2625                             | 2720                       | 1785   | 1850     | 1915      |
| 088 ARMLESS CHAIR BUMPER LEFT    | 45x40x33/40   | 1440    | 1535                  | 1630   | 1725   | 1820                             | 1915                       | 1130   | 1165     | 1200      |
| 089 ARMLESS CHAIR BUMPER RIGHT   | 45x40x33/40   | 1440    | 1535                  | 1630   | 1725   | 1820                             | 1915                       | 1130   | 1165     | 1200      |
| 095 APARTMENT SOFA               | 81x40x33/40   | 2940    | 3085                  | 3230   | 3375   | 3520                             | 3665                       | 2350   | 2445     | 2540      |
| 096 APARTMENT SOFA LEFT ARM      | 71x40x33/40   | 2570    | 2680                  | 2790   | 2900   | 3010                             | 3120                       | 2020   | 2110     | 2200      |
| 097 APARTMENT SOFA RIGHT ARM     | 71x40x33/40   | 2570    | 2680                  | 2790   | 2900   | 3010                             | 3120                       | 2020   | 2110     | 2200      |
| 124 STORAGE OTTOMAN              | 30x22x17      | 745     | 765                   | 785  | 805  | 825                              | 845                        | 650    | 670      | 690       |
| 138 STRAIGHT ARM                 | 10x36x24.5    | 415     | 450                   | 485  | 520  | 555                              | 590                        | 350    | 365      | 380       |

## MELBOURNE

- Manual adjustable headrest on all items (2 on square corner & stationary on wedge).
- \*Wall hugger power recliners with full footrest (manual n/a).
- Power recliner lounge chair (manual n/a) with power headrest in option. Wall clearance 8" & front 5".
- Seat cushions with shaped foam + 1" layer of memory foam on top; arm with memory foam.
- Stitching: Small thread in fabric & large flat thread in leather.
- \*Excludes 043 & 163 chairs: Wall clearance 16"

Note: 2 recliner seats separated by a corner can not be opened at the same time. No recliner seats beside #155 Small Square Corner.

### OPTIONS

Battery Pack: Add \$160/ea.

\*Motorized headrest: Add \$160 ea. (\*N/A on stationary items).

Foam: Extra firm add \$15/seat.

Choice of with or without "Wood Insert" in arm. If with wood insert, specify colour.

Choice of Large or Small 6" Arm: Leg on LARGE arm: LG103 wood or LG189 metal (Black or Chrome). SMALL Arm: LG08 wood or LG196 metal (Black or Chrome). Specify colour.

Seat Depth: 20" or \*22". \*22" seat depth N/A on chairs 043 & 163.

-043 & 163 Chairs: with wood base (specify colour).

### HOME THEATRE Configurations

For Accessories, Cup holders & Configuration details, see Optima Home Theatre page attached.

Accessory Dock : \$35 ea.

Cup Holders: Metal: \$25 ea. | LED lighted Cup Holder: \$25 ea. | \*LED lighted Cup Holder with (1 or 2 motor) controls: \$40 ea.

\*LED Light strip under seat: \$25/seat.

| Description                            | L x D x H     | Leather |                       |  |  |                                  |                           | Fabric |          |           |
|--|---------------|---------|-----------------------|--|--|----------------------------------|---------------------------|--------|----------|-----------|
|  |               | 10      | 20<br>Madras<br>Softy | 30<br>Hugo<br>Fantasy<br>Illusion<br>Tucson<br>Utah<br>Vintage<br>Wild Laredo<br>Yukon | 40<br>Elegance<br>Princess<br>Santiago<br>Sensation<br>Sunset<br>Trina<br>Victoria | 50<br>Bull<br>Cassiope<br>Dublin | 60<br>Caress<br>Ultrasued | A      | B<br>COM | C<br>alta |
| 155 SMALL SQUARE CORNER                | 40x40x33/40   | 1915    | 2010                  | 2105   | 2200   | 2295                             | 2390                      | 1510   | 1565     | 1620      |
| 159 WEDGE STORAGE                      | 13/28x36x24.5 | 745     | 775                   | 805  | 835  | 865                              | 895                       | 585    | 600      | 615       |
| 160 STRAIGHT STORAGE                   | 13x36x24.5    | 720     | 745                   | 770  | 795  | 820                              | 845                       | 550    | 570      | 590       |
| 163 DBL SWIVEL ROCKING RECLINER CHAIR  | 33x34x42      | 2290    | 2410                  | 2530   | 2650   | 2770                             | 2890                      | 1880   | 1930     | 1980      |
| 165 DOUBLE RECLINING CHAIR             | 51x40x33/40   | 2375    | 2475                  | 2575   | 2675   | 2775                             | 2875                      | 2000   | 2065     | 2130      |
| 167 APARTMENT SOFA NO ARM BUMPER LEFT  | 82x40x33/40   | 2490    | 2620                  | 2750   | 2880   | 3010                             | 3140                      | 1960   | 2045     | 2130      |
| 168 APARTMENT SOFA NO ARM BUMPER RIGHT | 82x40x33/40   | 2490    | 2620                  | 2750   | 2880   | 3010                             | 3140                      | 1960   | 2045     | 2130      |
| 169 DOUBLE RECLINING CHAIR LEFT ARM    | 41x40x33/40   | 1990    | 2070                  | 2150   | 2230   | 2310                             | 2390                      | 1670   | 1750     | 1830      |
| 170 DOUBLE RECLINING CHAIR RIGHT ARM   | 41x40x33/40   | 1990    | 2070                  | 2150   | 2230   | 2310                             | 2390                      | 1670   | 1750     | 1830      |
| 171 ARMLESS DOUBLE RECLINING CHAIR     | 30,5x40x33/40 | 1575    | 1625                  | 1675   | 1725   | 1775                             | 1825                      | 1320   | 1380     | 1440      |
| 173 DOUBLE LOUNGE CHAIR LEFT ARM       | 41x62x33/40   | 1915    | 2005                  | 2095   | 2185   | 2275                             | 2365                      | 1535   | 1615     | 1695      |
| 174 DOUBLE LOUNGE CHAIR RIGHT ARM      | 41x62x33/40   | 1915    | 2005                  | 2095   | 2185   | 2275                             | 2365                      | 1535   | 1615     | 1695      |
| 175 DOUBLE CHAIR LEFT ARM              | 41x40x33/40   | 1590    | 1680                  | 1770   | 1860   | 1950                             | 2040                      | 1285   | 1350     | 1415      |
| 176 DOUBLE CHAIR RIGHT ARM             | 41x40x33/40   | 1590    | 1680                  | 1770   | 1860   | 1950                             | 2040                      | 1285   | 1350     | 1415      |
| 177 ARMLESS DOUBLE CHAIR               | 30,5x40x33/40 | 1185    | 1250                  | 1315   | 1380   | 1445                             | 1510                      | 915    | 970      | 1025      |
| 178 ARMLESS DOUBLE CHAIR BUMPER LEFT   | 52x40x33/40   | 1545    | 1625                  | 1705   | 1785   | 1865                             | 1945                      | 1230   | 1290     | 1350      |

## MELBOURNE

- Manual adjustable headrest on all items (2 on square corner & stationary on wedge).
- \*Wall hugger power recliners with full footrest (manual n/a).
- Power recliner lounge chair (manual n/a) with power headrest in option. Wall clearance 8" & front 5".
- Seat cushions with shaped foam + 1" layer of memory foam on top; arm with memory foam.
- Stitching: Small thread in fabric & large flat thread in leather.
- \*Excludes 043 & 163 chairs: Wall clearance 16"

Note: 2 recliner seats separated by a corner can not be opened at the same time. No recliner seats beside #155 Small Square Corner.

### OPTIONS

Battery Pack: Add \$160/ea.

\*Motorized headrest: Add \$160 ea. (\*N/A on stationary items).

Foam: Extra firm add \$15/seat.

Choice of with or without "Wood Insert" in arm. If with wood insert, specify colour.

Choice of Large or Small 6" Arm: Leg on LARGE arm: LG103 wood or LG189 metal (Black or Chrome). SMALL Arm: LG08 wood or LG196 metal (Black or Chrome). Specify colour.

Seat Depth: 20" or \*22". \*22" seat depth N/A on chairs 043 & 163.

-043 & 163 Chairs: with wood base (specify colour).

### HOME THEATRE Configurations

For Accessories, Cup holders & Configuration details, see Optima Home Theatre page attached.

Accessory Dock : \$35 ea.

Cup Holders: Metal: \$25 ea. | LED lighted Cup Holder: \$25 ea. | \*LED lighted Cup Holder with (1 or 2 motor) controls: \$40 ea.

\*LED Light strip under seat: \$25/seat.

| Description                            | L x D x H       | Leather |                       |  |  |                                  |                           | Fabric |          |           |
|--|-----------------|---------|-----------------------|--|--|----------------------------------|---------------------------|--------|----------|-----------|
|  |                 | 10      | 20<br>Madras<br>Softy | 30<br>Hugo<br>Fantasy<br>Illusion<br>Tucson<br>Utah<br>Vintage<br>Wild Laredo<br>Yukon | 40<br>Elegance<br>Princess<br>Santiago<br>Sensation<br>Sunset<br>Trina<br>Victoria | 50<br>Bull<br>Cassiope<br>Dublin | 60<br>Caress<br>Ultrasued | A      | B<br>COM | C<br>alta |
| 179 ARMLESS DOUBLE CHAIR BUMPER RIGHT  | 52x40x33/40     | 1545    | 1625                  | 1705   | 1785   | 1865                             | 1945                      | 1230   | 1290     | 1350      |
| 186 ARMLESS LOVESEAT BUMPER STORAGE-L  | 68x40x33/40     | 2420    | 2500                  | 2580   | 2660   | 2740                             | 2820                      | 1950   | 2015     | 2080      |
| 187 ARMLESS LOVESEAT BUMPER STORAGE-R  | 68x40x33/40     | 2420    | 2500                  | 2580   | 2660   | 2740                             | 2820                      | 1950   | 2015     | 2080      |
| 188 ARMLESS CHAIR BUMPER STORAGE-L     | 45x40x33/40     | 1600    | 1690                  | 1780   | 1870   | 1960                             | 2050                      | 1295   | 1330     | 1365      |
| 189 ARMLESS CHAIR BUMPER STORAGE-R     | 45x40x33/40     | 1600    | 1690                  | 1780   | 1870   | 1960                             | 2050                      | 1295   | 1330     | 1365      |
| 190 SMALL WEDGE STORAGE                | 13/22x36x24.5   | 720     | 745                   | 770  | 795  | 820                              | 845                       | 550    | 570      | 590       |
| 221 ARMLESS DBL CHAIR BUMPER STORAGE-L | 52x40x33/40     | 1705    | 1790                  | 1875   | 1960   | 2045                             | 2130                      | 1390   | 1450     | 1510      |
| 222 ARMLESS DBL CHAIR BUMPER STORAGE-R | 52x40x33/40     | 1705    | 1790                  | 1875   | 1960   | 2045                             | 2130                      | 1390   | 1450     | 1510      |
| 223 APT SOFA NO ARM BUMPER STORAGE-L   | 82x40x33/40     | 2655    | 2785                  | 2915   | 3045   | 3175                             | 3305                      | 2120   | 2215     | 2310      |
| 224 APT SOFA NO ARM BUMPER STORAGE-R   | 82x40x33/40     | 2655    | 2785                  | 2915   | 3045   | 3175                             | 3305                      | 2120   | 2215     | 2310      |
| 236 RECLINING LOUNGE CHAIR LEFT ARM    | 34x62x33/40     | 2160    | 2225                  | 2290   | 2355   | 2420                             | 2485                      | 1820   | 1880     | 1940      |
| 237 RECLINING LOUNGE CHAIR RIGHT ARM   | 34x62x33/40     | 2160    | 2225                  | 2290   | 2355   | 2420                             | 2485                      | 1820   | 1880     | 1940      |
| 238 RECLINING DBL LOUNGE CHAIR L-ARM   | 41x62x33/40     | 2315    | 2405                  | 2495   | 2585   | 2675                             | 2765                      | 1940   | 2020     | 2100      |
| 239 RECLINING DBL LOUNGE CHAIR R-ARM   | 41x62x33/40     | 2315    | 2405                  | 2495   | 2585   | 2675                             | 2765                      | 1940   | 2020     | 2100      |
| V51 WINE GLASS HOLDER                  | 3.5 x 5.5 x 6.5 | 35      | 35                    | 35   | 35   | 35                               | 35                        | 35     | 35       | 35        |
| V52 PLASTIC SWIVEL TRAY                | 13 3/8 x 9 5/8  | 35      | 35                    | 35   | 35   | 35                               | 35                        | 35     | 35       | 35        |

## MELBOURNE

- Manual adjustable headrest on all items (2 on square corner & stationary on wedge).
- \*Wall hugger power recliners with full footrest (manual n/a).
- Power recliner lounge chair (manual n/a) with power headrest in option. Wall clearance 8" & front 5".
- Seat cushions with shaped foam + 1" layer of memory foam on top; arm with memory foam.
- Stitching: Small thread in fabric & large flat thread in leather.
- \*Excludes 043 & 163 chairs: Wall clearance 16"

Note: 2 recliner seats separated by a corner can not be opened at the same time. No recliner seats beside #155 Small Square Corner.

### OPTIONS

Battery Pack: Add \$160/ea.

\*Motorized headrest: Add \$160 ea. (\*N/A on stationary items).

Foam: Extra firm add \$15/seat.

Choice of with or without "Wood Insert" in arm. If with wood insert, specify colour.

Choice of Large or Small 6" Arm: Leg on LARGE arm: LG103 wood or LG189 metal (Black or Chrome). SMALL Arm: LG08 wood or LG196 metal (Black or Chrome). Specify colour.

Seat Depth: 20" or \*22". \*22" seat depth N/A on chairs 043 & 163.

-043 & 163 Chairs: with wood base (specify colour).

### HOME THEATRE Configurations

For Accessories, Cup holders & Configuration details, see Optima Home Theatre page attached.

Accessory Dock : \$35 ea.

Cup Holders: Metal: \$25 ea. | LED lighted Cup Holder: \$25 ea. | \*LED lighted Cup Holder with (1 or 2 motor) controls: \$40 ea.

\*LED Light strip under seat: \$25/seat.

| Description                 | L x D x H          | Leather |                       |  |  |                                  |                           | Fabric |          |           |
|-----------------------------|--------------------|---------|-----------------------|--|--|----------------------------------|---------------------------|--------|----------|-----------|
|                             |                    | 10      | 20<br>Madras<br>Softy | 30<br>Hugo<br>Fantasy<br>Illusion<br>Tucson<br>Utah<br>Vintage<br>Wild Laredo<br>Yukon | 40<br>Elegance<br>Princess<br>Santiago<br>Sensation<br>Sunset<br>Trina<br>Victoria | 50<br>Bull<br>Cassiope<br>Dublin | 60<br>Caress<br>Ultrasued | A      | B<br>COM | C<br>alta |
| V53 WOOD SWIVEL TRAY        | 19 x 10            | 60      | 60                    | 60   | 60   | 60                               | 60                        | 60     | 60       | 60        |
| V54 TABLET HOLDER           | 4.5 x 8 x 10       | 40      | 40                    | 40   | 40   | 40                               | 40                        | 40     | 40       | 40        |
| V55 LED LAMP                | 1.5x5x14 plié/bent | 35      | 35                    | 35   | 35   | 35                               | 35                        | 35     | 35       | 35        |
| <b>CONFIGURATIONS</b>       |                    |         |                       |  |  |                                  |                           |        |          |           |
| _A CONFIG (169-170)         | 82X40X40           | 3980    | 4140                  | 4300   | 4460   | 4620                             | 4780                      | 3340   | 3500     | 3660      |
| _B CONFIG (169-171-174)     | 113X62X40          | 5480    | 5700                  | 5920   | 6140   | 6360                             | 6580                      | 4525   | 4745     | 4965      |
| _C CONFIG (096-055-171-170) | 115X115X40         | 8050    | 8385                  | 8720   | 9055   | 9390                             | 9725                      | 6520   | 6805     | 7090      |
| _D CONFIG (169-171-055-179) | 115X96X40          | 7025    | 7330                  | 7635   | 7940   | 8245                             | 8550                      | 5730   | 5985     | 6240      |
| _J CONFIG (041-042)         | 68X40X40           | 3770    | 3920                  | 4070   | 4220   | 4370                             | 4520                      | 3210   | 3280     | 3350      |
| _K CONFIG (041-071-005)     | 92X62X40           | 5120    | 5315                  | 5510   | 5705   | 5900                             | 6095                      | 4265   | 4420     | 4575      |
| _L CONFIG (012-055-071-042) | 102X102X40         | 7590    | 7915                  | 8240   | 8565   | 8890                             | 9215                      | 6215   | 6440     | 6665      |
| _M CONFIG (041-071-055-089) | 102X89X40          | 6710    | 7030                  | 7350   | 7670   | 7990                             | 8310                      | 5495   | 5680     | 5865      |



# MELBOURNE

**OPTIMA**  
Collection

**Jaymar**

Conçu et fabriqué fièrement au Canada  
Proudly designed and made in Canada

Nos produits sont fabriqués à la main et des variations mineures peuvent survenir

Our product is hand-made and minor variations can occur.

## SPECIFICATIONS

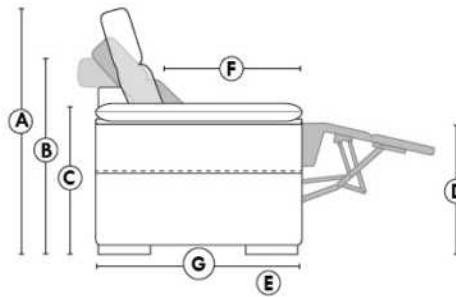

- Appui-tête levé / Headrest up
- Appui-tête baissé / Headrest down
- Complètement incliné / Fully reclined

- A** Hauteur complète 40" Total Height
- B** Hauteur appui-tête baissé 33" Height headrest down
- C** Hauteur du bras 24,5" Arm Height
- D** Hauteur du siège 19,5" Seat height
- E** Profondeur inclinée 65" Depth fully reclined
- F** Profondeur d'assise 20"ou/ou 22" Seat depth
- G** Profondeur appui-tête monté 37,5" Depth with headrest up

## BRAS | ARMS

Option de bras:  
Bras Régulier Large 10" ou Petit bras 6"  
Arm option  
Regular arm Large 10" or Small arm 6"

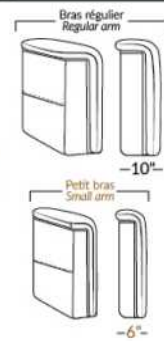

Contrôle de l'inclinaison situé à l'extérieur du bras  
Recliner control located on the outside of the arm.

## FAUTEUIL BERÇANT PIVOTANT INCLINABLE SWIVEL ROCKING MOTION CHAIR

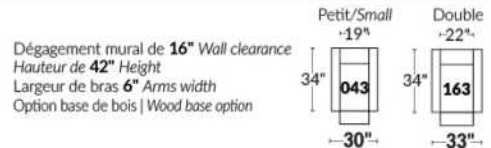

## SIÈGE 23" DE LARGE | 23" SEAT WIDTH

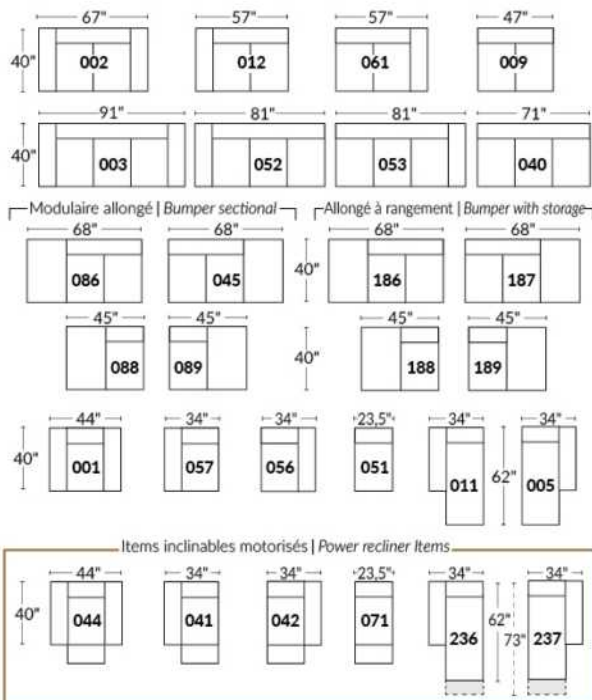

## SIÈGE 30" DE LARGE | 30" SEAT WIDTH

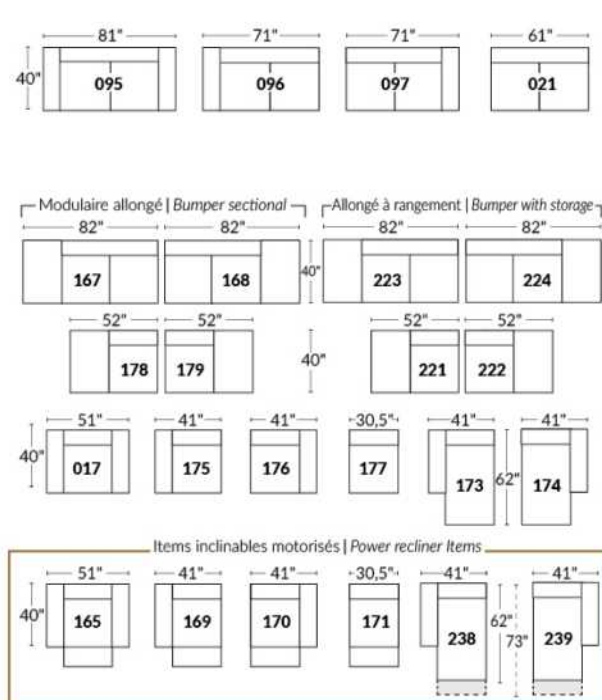

## Autres | Others

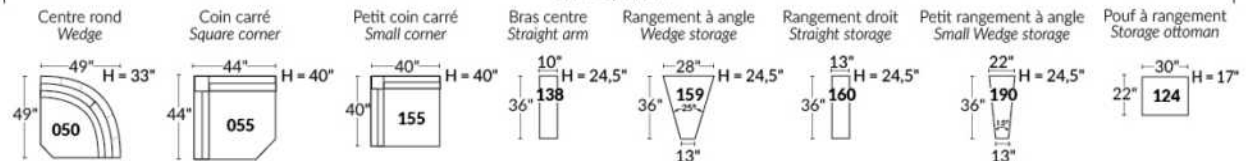

## EXEMPLE 23" EXAMPLE

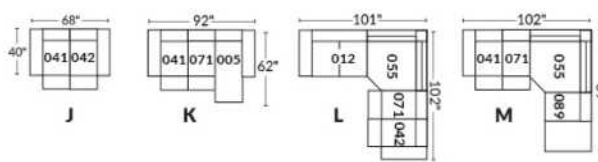

## EXEMPLE 30" EXAMPLE

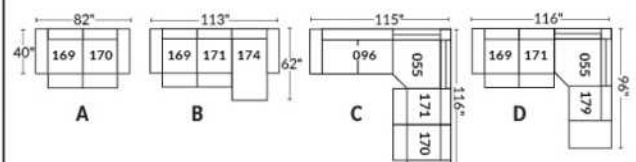



\*Available on certain models and on large arms ONLY.

### OPTIONS CUP HOLDERS

#### METAL



Silver



Matte Black



Brown

#### ILLUMINATED

1.



LED Lighted Cup holder

2.



LED Lighted Cup holder with Single Motor Control, USB Port and LED Base rail

3.



LED Lighted Cup holder with Dual Motor Control, USB Port and LED Base rail

Our illuminated one or two-control cup holders are compatible with LED lights under the seat. You can control the light on the cup holder. The 2 motor cup holder has a reset (home) button control to close your recliner back to its starting position.

#### LED Light under seat (Optional)

Available only in configurations with a minimum of 1 illuminated motorized cup holder with control buttons. The "light" button will control the opening and closing of the light.

For cup holder prices see description section of the Optima model price list.

Please provide us with a drawing of your configuration which indicates the cup holder type and its positioning.

#### Cup holder with controller:

It is important to specify the placement of the cups; on left arm or right arm and which recliner they will control. If you have a row of several seats with cup holders, by default, the controls will be on the left arms and on the right arm for the last outer chair.

#### EXAMPLE A:

041-169: Controller and cup holder on the left arm

071-171: hidden touch sensor buttons on side of seat

042-170: Controller and cup holder on right arm



#### EXAMPLE B:

071-171: These two items can be connected to a smart cup holder which will control the recliner. You must then use one of these items: 138, 159, 160 and 190



#### Informations about headrest, controller on reclining seat

#### WITH illuminated cup holder

If you have a **stationary item**, you will have cup holder N°1.

If you have a recliner chair with a **manual headrest**, you will have the cup holder N°2.

If you have a recliner chair with an **electric headrest**, you will have cup holder N°3.

#### Without cup holder and with a reclining seat

If you have a recliner with a **manual headrest** you will have the touch sensor button control on the side of the seat.

If you have a recliner with an **electric headrest** you will have a dual push button controller with USB port on the arm.

If you have an **armless recliner**, you will have the hidden touch sensor button control.



Hidden touch sensor



Dual push button



# OPTIMA

## HOME THEATRE Configurations

\*Available on certain models and on large arms ONLY.

OPTIONS

### ACCESSORIES

Accessory Dock



V51 Wine Glass Holder



V52 Plastic Swivel Tray Table



V53 Wood Swivel tray Table  
(Choice of 8 colors)



Specify on which arm (left or right) the tray table will be installed.

V54 Tablet Holder



V55 LED Lamp



(For Accessory Dock price, see description section of the Optima model price list and for Accessory item prices, see at very end of the price list)

### Items 138-159-160-190 and large arm.

Accessory docks and cups are Optional. \*Not available on small arms\*

Please specify on which arms you want the accessory docks and cup holders.

NB: Item 138-159-160-190 are unfinished on the sides, must be used between 2 seats.

Each storage item has 2 USB ports and one electrical outlet inside the storage.



### SUGGESTED CONFIGURATIONS

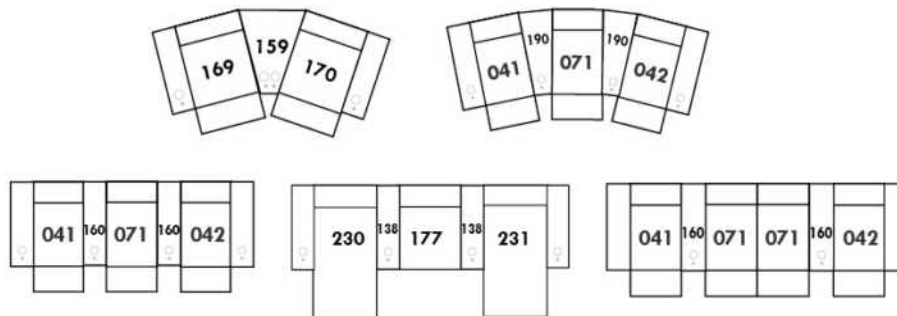



## MONACO

Features: Manual adjustable headrest with all items (2 on square corner). Stitching: Small thread in fabric & large flat thread in leather. Memory foam in arms & seat cushions.

NOTE: 2 recliner seats SEPARATED by a CORNER or TABLE (154) cannot be opened at the same time.

OPTIONS - Provide SKETCH of your config:

Leg: LG189 metal (Black or Chrome) or LG187 wood (specify colour).

Table (154): Specify colour of wood table top.

043 & 163 Chairs: with wood base (specify colour).

Accessories: Anchorage \$35 ea. | Plastic Swivel tray & Wine Glass holder \$35 ea. | Wood Swivel tray \$60 ea. | Tablet holder \$40 ea. & LED Lamp \$35 ea.

\*\*MANUAL RECLINER N/A.\*\* Motorized mechanism included in price of recliner chair items. For Battery Pack add \$160/mechanism.

| Description                        | L x D x H     | Leather |                       |  |  |                                  |                           | Fabric |          |           |
|------------------------------------|---------------|---------|-----------------------|--|--|----------------------------------|---------------------------|--------|----------|-----------|
|                                    |               | 10      | 20<br>Madras<br>Softy | 30<br>Hugo<br>Fantasy<br>Illusion<br>Tucson<br>Utah<br>Vintage<br>Wild Laredo<br>Yukon | 40<br>Elegance<br>Princess<br>Santiago<br>Sensation<br>Sunset<br>Trina<br>Victoria | 50<br>Bull<br>Cassiope<br>Dublin | 60<br>Caress<br>Ultrasued | A      | B<br>COM | C<br>alta |
| 001 CHAIR                          | 42x40x30/39   | 1695    | 1785                  | 1875   | 1965   | 2055                             | 2145                      | 1285   | 1320     | 1355      |
| 002 LOVESEAT                       | 65x40x30/39   | 2495    | 2615                  | 2735   | 2855   | 2975                             | 3095                      | 1875   | 1955     | 2035      |
| 003 SOFA                           | 89x40x30/39   | 3060    | 3210                  | 3360   | 3510   | 3660                             | 3810                      | 2320   | 2395     | 2470      |
| 005 LOUNGE CHAIR RIGHT ARM         | 33x62x30/39   | 1600    | 1680                  | 1760   | 1840   | 1920                             | 2000                      | 1200   | 1280     | 1360      |
| 009 ARMLESS LOVESEAT               | 47x40x30/39   | 1865    | 1940                  | 2015   | 2090   | 2165                             | 2240                      | 1410   | 1485     | 1560      |
| 011 LOUNGE CHAIR LEFT ARM          | 33x62x30/39   | 1600    | 1680                  | 1760   | 1840   | 1920                             | 2000                      | 1200   | 1280     | 1360      |
| 012 LOVESEAT LEFT ARM              | 56x40x30/39   | 2180    | 2290                  | 2400   | 2510   | 2620                             | 2730                      | 1635   | 1715     | 1795      |
| 017 DOUBLE CHAIR                   | 49x40x30/39   | 1795    | 1905                  | 2015   | 2125   | 2235                             | 2345                      | 1335   | 1390     | 1445      |
| 021 APARTMENT SOFA NO ARM          | 61x40x30/39   | 2095    | 2190                  | 2285   | 2380   | 2475                             | 2570                      | 1605   | 1675     | 1745      |
| 040 ARMLESS SOFA                   | 71x40x30/39   | 2435    | 2525                  | 2615   | 2705   | 2795                             | 2885                      | 1830   | 1935     | 2040      |
| 041 RECLINING CHAIR LEFT ARM       | 33x40x30/39   | 1745    | 1815                  | 1885   | 1955   | 2025                             | 2095                      | 1400   | 1465     | 1530      |
| 042 RECLINING CHAIR RIGHT ARM      | 33x40x30/39   | 1745    | 1815                  | 1885   | 1955   | 2025                             | 2095                      | 1400   | 1465     | 1530      |
| 043 SWIVEL ROCKING RECLINING CHAIR | 30x34x42      | 2150    | 2245                  | 2340   | 2435   | 2530                             | 2625                      | 1790   | 1835     | 1880      |
| 044 RECLINER CHAIR                 | 42x40x30/39   | 2060    | 2155                  | 2250   | 2345   | 2440                             | 2535                      | 1640   | 1690     | 1740      |
| 045 ARMLESS LOVESEAT BUMPER RIGHT  | 68x40x30/39   | 2185    | 2300                  | 2415   | 2530   | 2645                             | 2760                      | 1655   | 1730     | 1805      |
| 051 ARMLESS CHAIR                  | 23,5x40x30/39 | 1060    | 1110                  | 1160   | 1210   | 1260                             | 1310                      | 795    | 855      | 915       |
| 052 SOFA LEFT ARM                  | 80x40x30/39   | 2735    | 2855                  | 2975   | 3095   | 3215                             | 3335                      | 2080   | 2170     | 2260      |
| 053 SOFA RIGHT ARM                 | 80x 40x30/39  | 2735    | 2855                  | 2975   | 3095   | 3215                             | 3335                      | 2080   | 2170     | 2260      |
| 055 SQUARE CORNER                  | 44x44x30/39   | 1945    | 2040                  | 2135   | 2230   | 2325                             | 2420                      | 1490   | 1540     | 1590      |
| 056 CHAIR RIGHT ARM                | 33x40x30/39   | 1365    | 1450                  | 1535   | 1620   | 1705                             | 1790                      | 1030   | 1080     | 1130      |
| 057 CHAIR LEFT ARM                 | 33x40x30/39   | 1365    | 1450                  | 1535   | 1620   | 1705                             | 1790                      | 1030   | 1080     | 1130      |



## MONACO

Features: Manual adjustable headrest with all items (2 on square corner). Stitching: Small thread in fabric & large flat thread in leather. Memory foam in arms & seat cushions.

NOTE: 2 recliner seats SEPARATED by a CORNER or TABLE (154) cannot be opened at the same time.

OPTIONS - Provide SKETCH of your config:

Leg: LG189 metal (Black or Chrome) or LG187 wood (specify colour).

Table (154): Specify colour of wood table top.

043 & 163 Chairs: with wood base (specify colour).

Accessories: Anchorage \$35 ea. | Plastic Swivel tray & Wine Glass holder \$35 ea. | Wood Swivel tray \$60 ea. | Tablet holder \$40 ea. & LED Lamp \$35 ea.

\*\*MANUAL RECLINER N/A.\*\* Motorized mechanism included in price of recliner chair items. For Battery Pack add \$160/mechanism.

| Description                            | L x D x H      | Leather |                       |  |  |                                  |                           | Fabric |          |           |
|--|----------------|---------|-----------------------|--|--|----------------------------------|---------------------------|--------|----------|-----------|
|  |                | 10      | 20<br>Madras<br>Softy | 30<br>Hugo<br>Fantasy<br>Illusion<br>Tucson<br>Utah<br>Vintage<br>Wild Laredo<br>Yukon | 40<br>Elegance<br>Princess<br>Santiago<br>Sensation<br>Sunset<br>Trina<br>Victoria | 50<br>Bull<br>Cassiope<br>Dublin | 60<br>Caress<br>Ultrasued | A      | B<br>COM | C<br>alta |
| 061 LOVESEAT RIGHT ARM                 | 56x40x30/39    | 2180    | 2290                  | 2400   | 2510   | 2620                             | 2730                      | 1635   | 1715     | 1795      |
| 071 ARMLESS RECLINING CHAIR            | 23,5x40x/30/39 | 1420    | 1475                  | 1530   | 1585   | 1640                             | 1695                      | 1170   | 1235     | 1300      |
| 086 ARMLESS LOVESEAT BUMPER LEFT       | 68x40x30/39    | 2185    | 2300                  | 2415   | 2530   | 2645                             | 2760                      | 1655   | 1730     | 1805      |
| 088 ARMLESS CHAIR BUMPER LEFT          | 45x40x/30/39   | 1370    | 1460                  | 1550   | 1640   | 1730                             | 1820                      | 1055   | 1115     | 1175      |
| 089 ARMLESS CHAIR BUMPER RIGHT         | 45x40x30/39    | 1370    | 1460                  | 1550   | 1640   | 1730                             | 1820                      | 1055   | 1115     | 1175      |
| 095 APARTMENT SOFA                     | 79x40x30/39    | 2735    | 2885                  | 3035   | 3185   | 3335                             | 3485                      | 2075   | 2160     | 2245      |
| 096 APARTMENT SOFA LEFT ARM            | 70x40x30/39    | 2435    | 2565                  | 2695   | 2825   | 2955                             | 3085                      | 1825   | 1915     | 2005      |
| 097 APARTMENT SOFA RIGHT ARM           | 70x40x30/39    | 2435    | 2565                  | 2695   | 2825   | 2955                             | 3085                      | 1825   | 1915     | 2005      |
| 124 STORAGE OTTOMAN                    | 30x22x17       | 705     | 730                   | 755  | 780  | 805                              | 830                       | 605    | 615      | 625       |
| 154 UPHOLSTERED ANGULAR TABLE          | 7/34x33.5x19   | 600     | 625                   | 650  | 675  | 700                              | 725                       | 515    | 530      | 545       |
| 163 DBL SWIVEL ROCKING RECLINER CHAIR  | 33 x 34 x 42   | 2200    | 2315                  | 2430   | 2545   | 2660                             | 2775                      | 1795   | 1840     | 1885      |
| 165 DOUBLE RECLINING CHAIR             | 49x40x30/39    | 2160    | 2255                  | 2350   | 2445   | 2540                             | 2635                      | 1710   | 1785     | 1860      |
| 167 APARTMENT SOFA NO ARM BUMPER LEFT  | 82x40x30/39    | 2440    | 2580                  | 2720   | 2860   | 3000                             | 3140                      | 1835   | 1935     | 2035      |
| 168 APARTMENT SOFA NO ARM BUMPER RIGHT | 82x40x30/39    | 2440    | 2580                  | 2720   | 2860   | 3000                             | 3140                      | 1835   | 1935     | 2035      |
| 169 DOUBLE RECLINING CHAIR LEFT ARM    | 40x40x30/39    | 1830    | 1925                  | 2020   | 2115   | 2210                             | 2305                      | 1490   | 1545     | 1600      |
| 170 DOUBLE RECLINING CHAIR RIGHT ARM   | 40x40x30/39    | 1830    | 1925                  | 2020   | 2115   | 2210                             | 2305                      | 1490   | 1545     | 1600      |
| 171 ARMLESS DOUBLE RECLINING CHAIR     | 30,5x40x30/39  | 1525    | 1590                  | 1655   | 1720   | 1785                             | 1850                      | 1240   | 1305     | 1370      |
| 173 DOUBLE LOUNGE CHAIR LEFT ARM       | 40x62x30/39    | 1755    | 1840                  | 1925   | 2010   | 2095                             | 2180                      | 1325   | 1390     | 1455      |
| 174 DOUBLE LOUNGE CHAIR RIGHT ARM      | 40x62x30/39    | 1755    | 1840                  | 1925   | 2010   | 2095                             | 2180                      | 1325   | 1390     | 1455      |
| 175 DOUBLE CHAIR LEFT ARM              | 40x40x30/39    | 1470    | 1550                  | 1630   | 1710   | 1790                             | 1870                      | 1125   | 1175     | 1225      |
| 176 DOUBLE CHAIR RIGHT ARM             | 40x40x30/39    | 1470    | 1550                  | 1630   | 1710   | 1790                             | 1870                      | 1125   | 1175     | 1225      |
| 177 ARMLESS DOUBLE CHAIR               | 30,5x40x30/39  | 1150    | 1225                  | 1300   | 1375   | 1450                             | 1525                      | 880    | 940      | 1000      |



## MONACO

Features: Manual adjustable headrest with all items (2 on square corner). Stitching: Small thread in fabric & large flat thread in leather. Memory foam in arms & seat cushions.

NOTE: 2 recliner seats SEPARATED by a CORNER or TABLE (154) cannot be opened at the same time.

OPTIONS - Provide SKETCH of your config:

Leg: LG189 metal (Black or Chrome) or LG187 wood (specify colour).

Table (154): Specify colour of wood table top.

043 & 163 Chairs: with wood base (specify colour).

Accessories: Anchorage \$35 ea. | Plastic Swivel tray & Wine Glass holder \$35 ea. | Wood Swivel tray \$60 ea. | Tablet holder \$40 ea. & LED Lamp \$35 ea.

\*\*MANUAL RECLINER N/A.\*\* Motorized mechanism included in price of recliner chair items. For Battery Pack add \$160/mechanism.

| Description                           | L x D x H     | Leather |                       |  |  |                                  |                           | Fabric |          |           |
|---------------------------------------|---------------|---------|-----------------------|--|--|----------------------------------|---------------------------|--------|----------|-----------|
|                                       |               | 10      | 20<br>Madras<br>Softy | 30<br>Hugo<br>Fantasy<br>Illusion<br>Tucson<br>Utah<br>Vintage<br>Wild Laredo<br>Yukon | 40<br>Elegance<br>Princess<br>Santiago<br>Sensation<br>Sunset<br>Trina<br>Victoria | 50<br>Bull<br>Cassiope<br>Dublin | 60<br>Caress<br>Ultrasued | A      | B<br>COM | C<br>alta |
| 178 ARMLESS DOUBLE CHAIR BUMPER LEFT  | 52x40x30/39   | 1485    | 1575                  | 1665   | 1755   | 1845                             | 1935                      | 1140   | 1205     | 1270      |
| 179 ARMLESS DOUBLE CHAIR BUMPER RIGHT | 52x40x30/39   | 1485    | 1575                  | 1665   | 1755   | 1845                             | 1935                      | 1140   | 1205     | 1270      |
| <b>CONFIGURATIONS</b>                 |               |         |                       |  |  |                                  |                           |        |          |           |
| A CONFIG (169-170)                    | 80X40X30/39   | 3660    | 3850                  | 4040   | 4230   | 4420                             | 4610                      | 2980   | 3090     | 3200      |
| B CONFIG (169-171-174)                | 111X62X30/39  | 5110    | 5355                  | 5600   | 5845   | 6090                             | 6335                      | 4055   | 4240     | 4425      |
| C CONFIG (096-055-171-170)            | 114X115X30/39 | 7735    | 8120                  | 8505   | 8890   | 9275                             | 9660                      | 6045   | 6305     | 6565      |
| D CONFIG (169-171-055-179)            | 115X96X30/39  | 6785    | 7130                  | 7475   | 7820   | 8165                             | 8510                      | 5360   | 5595     | 5830      |
| J CONFIG (041-042)                    | 66X40X30/39   | 3490    | 3630                  | 3770   | 3910   | 4050                             | 4190                      | 2800   | 2930     | 3060      |
| K CONFIG (041-071-005)                | 90X62X30/39   | 4765    | 4970                  | 5175   | 5380   | 5585                             | 5790                      | 3770   | 3980     | 4190      |
| L CONFIG (012-055-071-042)            | 100X101X30/39 | 7290    | 7620                  | 7950   | 8280   | 8610                             | 8940                      | 5695   | 5955     | 6215      |
| M CONFIG (041-071-055-089)            | 101X89X30/39  | 6480    | 6790                  | 7100   | 7410   | 7720                             | 8030                      | 5115   | 5355     | 5595      |



# MONACO

LINEA 30 Collection



Conçu et fabriqué fièrement au Canada  
Proudly designed and made in Canada

Nos produits sont fabriqués à la main et des variations mineures peuvent survenir

Our product is hand-made and minor variations can occur.

## SPECIFICATIONS

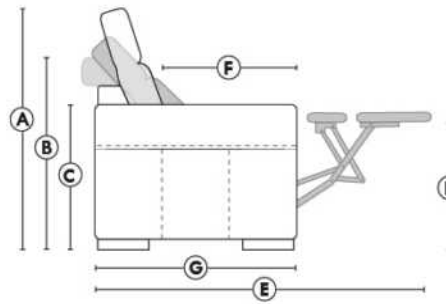

- Appui-tête levé / Headrest up
- Appui-tête baissé / Headrest down
- Complètement incliné / Fully reclined

- (A) Hauteur complète 39" Total Height
- (B) Hauteur appui-tête baissé 30" Height headrest down
- (C) Hauteur du bras 24" Arm Height
- (D) Hauteur du siège 19,5" Seat height
- (E) Profondeur inclinée 63" Depth fully reclined
- (F) Profondeur d'assise 20" Seat depth
- (G) Profondeur appui-tête monté 37,5" Depth with headrest up

## BRAS | ARMS

Contrôle de l'inclinaison situé à l'intérieur du bras  
Recliner control located on the inside of the arm.

Option d'accessoires disponible  
Accessories option, available

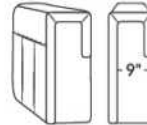

## FAUTEUIL BERÇANT PIVOTANT INCLINABLE SWIVEL ROCKING MOTION CHAIR

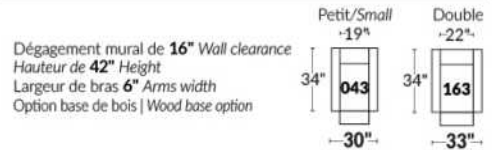

## SIÈGE 23" DE LARGE | 23" SEAT WIDTH

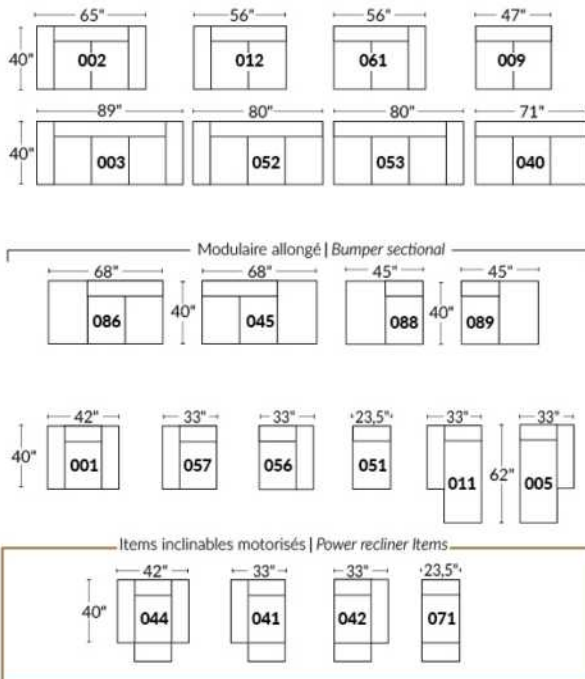

## SIÈGE 30" DE LARGE | 30" SEAT WIDTH

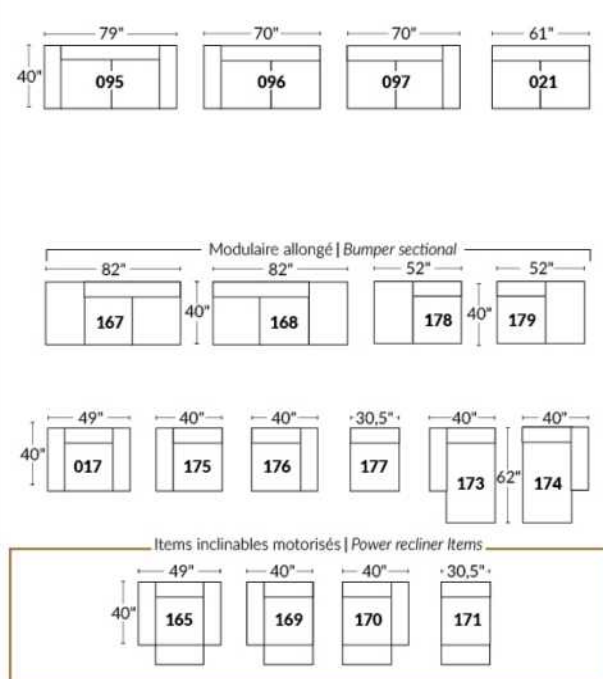

## Autres | Others

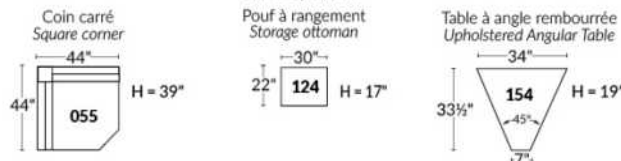

## EXEMPLE 23" EXAMPLE

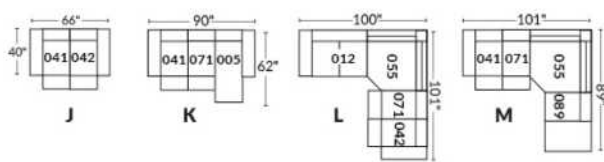

## EXEMPLE 30" EXAMPLE

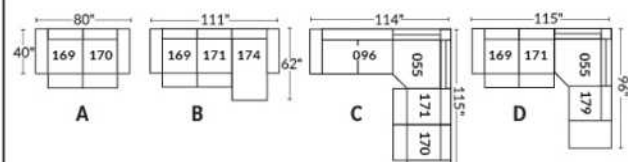



## MONTE-CARLO

Features: Manual adjustable headrest included with all items (2 with square corner). Stitching: French Stitch. In fabric: small thread & in Leather: Large flat thread. Memory foam in arms & seat cushions. Cupholder N/A with this style.

NOTE: 2 recliner seats SEPARATED by a CORNER or TABLE (154) cannot be opened at the same time.

OPTIONS - Provide SKETCH of your config.:  
Leg: LG64 metal or LG08 wood; specify colour of wood legs.  
Table (154): Specify colour of wood table top.  
043 & 163 Chairs: with wood base (specify colour).

\*\*MANUAL RECLINER N/A.\*\* Motorized mechanism included in price of recliner chair items. For Battery Pack add \$160/mechanism.

| Description                        | L x D x H     | Leather |                       |  |  |                                  |                           | Fabric |          |           |
|------------------------------------|---------------|---------|-----------------------|--|--|----------------------------------|---------------------------|--------|----------|-----------|
|                                    |               | 10      | 20<br>Madras<br>Softy | 30<br>Hugo<br>Fantasy<br>Illusion<br>Tucson<br>Utah<br>Vintage<br>Wild Laredo<br>Yukon | 40<br>Elegance<br>Princess<br>Santiago<br>Sensation<br>Sunset<br>Trina<br>Victoria | 50<br>Bull<br>Cassiope<br>Dublin | 60<br>Caress<br>Ultrasued | A      | B<br>COM | C<br>alta |
| 001 CHAIR                          | 36x40x30/39   | 1620    | 1715                  | 1810   | 1905   | 2000                             | 2095                      | 1180   | 1245     | 1310      |
| 002 LOVESEAT                       | 59x40x30/39   | 2440    | 2570                  | 2700   | 2830   | 2960                             | 3090                      | 1805   | 1875     | 1945      |
| 003 SOFA                           | 83x40x30/39   | 2975    | 3135                  | 3295   | 3455   | 3615                             | 3775                      | 2220   | 2330     | 2440      |
| 005 LOUNGE CHAIR RIGHT ARM         | 30x62x30/39   | 1575    | 1635                  | 1695   | 1755   | 1815                             | 1875                      | 1155   | 1225     | 1295      |
| 009 ARMLESS LOVESEAT               | 47x40x30/39   | 1865    | 1940                  | 2015   | 2090   | 2165                             | 2240                      | 1410   | 1485     | 1560      |
| 011 LOUNGE CHAIR LEFT ARM          | 30x62x30/39   | 1575    | 1635                  | 1695   | 1755   | 1815                             | 1875                      | 1155   | 1225     | 1295      |
| 012 LOVESEAT LEFT ARM              | 53x40x30/39   | 2145    | 2240                  | 2335   | 2430   | 2525                             | 2620                      | 1610   | 1670     | 1730      |
| 017 DOUBLE CHAIR                   | 43x40x30/39   | 1720    | 1820                  | 1920   | 2020   | 2120                             | 2220                      | 1285   | 1335     | 1385      |
| 021 APARTMENT SOFA NO ARM          | 61x40x30/39   | 2095    | 2190                  | 2285   | 2380   | 2475                             | 2570                      | 1605   | 1675     | 1745      |
| 040 ARMLESS SOFA                   | 71x40x30/39   | 2435    | 2525                  | 2615   | 2705   | 2795                             | 2885                      | 1830   | 1935     | 2040      |
| 041 RECLINING CHAIR LEFT ARM       | 30x40x30/39   | 1705    | 1780                  | 1855   | 1930   | 2005                             | 2080                      | 1360   | 1415     | 1470      |
| 042 RECLINING CHAIR RIGHT ARM      | 30x40x30/39   | 1705    | 1780                  | 1855   | 1930   | 2005                             | 2080                      | 1360   | 1415     | 1470      |
| 043 SWIVEL ROCKING RECLINING CHAIR | 30 x 34 x 42  | 2150    | 2245                  | 2340   | 2435   | 2530                             | 2625                      | 1790   | 1835     | 1880      |
| 044 RECLINER CHAIR                 | 36x40x30/39   | 1985    | 2090                  | 2195   | 2300   | 2405                             | 2510                      | 1560   | 1615     | 1670      |
| 045 ARMLESS LOVESEAT BUMPER RIGHT  | 68x40x30/39   | 2185    | 2300                  | 2415   | 2530   | 2645                             | 2760                      | 1655   | 1730     | 1805      |
| 051 ARMLESS CHAIR                  | 23,5x40x30/39 | 1060    | 1110                  | 1160   | 1210   | 1260                             | 1310                      | 795    | 855      | 915       |
| 052 SOFA LEFT ARM                  | 77x40x30/39   | 2700    | 2835                  | 2970   | 3105   | 3240                             | 3375                      | 2045   | 2125     | 2205      |
| 053 SOFA RIGHT ARM                 | 77x40x30/39   | 2700    | 2835                  | 2970   | 3105   | 3240                             | 3375                      | 2045   | 2125     | 2205      |
| 055 SQUARE CORNER                  | 44x44x30/39   | 1945    | 2040                  | 2135   | 2230   | 2325                             | 2420                      | 1490   | 1540     | 1590      |
| 056 CHAIR RIGHT ARM                | 30x40x30/39   | 1335    | 1410                  | 1485   | 1560   | 1635                             | 1710                      | 995    | 1040     | 1085      |
| 057 CHAIR LEFT ARM                 | 30x40x30/39   | 1335    | 1410                  | 1485   | 1560   | 1635                             | 1710                      | 995    | 1040     | 1085      |
| 061 LOVESEAT RIGHT ARM             | 53x40x30/39   | 2145    | 2240                  | 2335   | 2430   | 2525                             | 2620                      | 1610   | 1670     | 1730      |
| 071 ARMLESS RECLINING CHAIR        | 23,5x40x30/39 | 1420    | 1475                  | 1530   | 1585   | 1640                             | 1695                      | 1170   | 1235     | 1300      |



## MONTE-CARLO

Features: Manual adjustable headrest included with all items (2 with square corner). Stitching: French Stitch. In fabric: small thread & in Leather: Large flat thread. Memory foam in arms & seat cushions. Cupholder N/A with this style.

NOTE: 2 recliner seats SEPARATED by a CORNER or TABLE (154) cannot be opened at the same time.

OPTIONS - Provide SKETCH of your config.:  
Leg: LG64 metal or LG08 wood; specify colour of wood legs.  
Table (154): Specify colour of wood table top.  
043 & 163 Chairs: with wood base (specify colour).

\*\*MANUAL RECLINER N/A.\*\* Motorized mechanism included in price of recliner chair items. For Battery Pack add \$160/mechanism.

| Description                            | L x D x H     | Leather |                       |  |  |                                  |                           | Fabric |          |           |
|--|---------------|---------|-----------------------|--|--|----------------------------------|---------------------------|--------|----------|-----------|
|  |               | 10      | 20<br>Madras<br>Softy | 30<br>Hugo<br>Fantasy<br>Illusion<br>Tucson<br>Utah<br>Vintage<br>Wild Laredo<br>Yukon | 40<br>Elegance<br>Princess<br>Santiago<br>Sensation<br>Sunset<br>Trina<br>Victoria | 50<br>Bull<br>Cassiope<br>Dublin | 60<br>Caress<br>Ultrasued | A      | B<br>COM | C<br>alta |
| 086 ARMLESS LOVESEAT BUMPER LEFT       | 68x40x30/39   | 2185    | 2300                  | 2415   | 2530   | 2645                             | 2760                      | 1655   | 1730     | 1805      |
| 088 ARMLESS CHAIR BUMPER LEFT          | 45x40x30/39   | 1370    | 1460                  | 1550   | 1640   | 1730                             | 1820                      | 1055   | 1115     | 1175      |
| 089 ARMLESS CHAIR BUMPER RIGHT         | 45x40x30/39   | 1370    | 1460                  | 1550   | 1640   | 1730                             | 1820                      | 1055   | 1115     | 1175      |
| 095 APARTMENT SOFA                     | 73x40x30/39   | 2675    | 2815                  | 2955   | 3095   | 3235                             | 3375                      | 1990   | 2080     | 2170      |
| 096 APARTMENT SOFA LEFT ARM            | 67x40x30/39   | 2365    | 2485                  | 2605   | 2725   | 2845                             | 2965                      | 1795   | 1875     | 1955      |
| 097 APARTMENT SOFA RIGHT ARM           | 67x40x30/39   | 2365    | 2485                  | 2605   | 2725   | 2845                             | 2965                      | 1795   | 1875     | 1955      |
| 124 STORAGE OTTOMAN                    | 30x22x17      | 705     | 730                   | 755  | 780  | 805                              | 830                       | 605    | 615      | 625       |
| 154 UPHOLSTERED ANGULAR TABLE          | 7/34x33.5x19  | 600     | 625                   | 650  | 675  | 700                              | 725                       | 515    | 530      | 545       |
| 163 DBL SWIVEL ROCKING RECLINER CHAIR  | 33 x 34 x 42  | 2200    | 2315                  | 2430   | 2545   | 2660                             | 2775                      | 1795   | 1840     | 1885      |
| 165 DOUBLE RECLINING CHAIR             | 43x40x30/39   | 2080    | 2185                  | 2290   | 2395   | 2500                             | 2605                      | 1640   | 1705     | 1770      |
| 167 APARTMENT SOFA NO ARM BUMPER LEFT  | 82x40x30/39   | 2440    | 2580                  | 2720   | 2860   | 3000                             | 3140                      | 1835   | 1935     | 2035      |
| 168 APARTMENT SOFA NO ARM BUMPER RIGHT | 82x40x30/39   | 2440    | 2580                  | 2720   | 2860   | 3000                             | 3140                      | 1835   | 1935     | 2035      |
| 169 DOUBLE RECLINING CHAIR LEFT ARM    | 37x40x30/39   | 1805    | 1890                  | 1975   | 2060   | 2145                             | 2230                      | 1450   | 1515     | 1580      |
| 170 DOUBLE RECLINING CHAIR RIGHT ARM   | 37x40x30/39   | 1805    | 1890                  | 1975   | 2060   | 2145                             | 2230                      | 1450   | 1515     | 1580      |
| 171 ARMLESS DOUBLE RECLINING CHAIR     | 30,5x40x30/39 | 1525    | 1590                  | 1655   | 1720   | 1785                             | 1850                      | 1240   | 1305     | 1370      |
| 173 DOUBLE LOUNGE CHAIR LEFT ARM       | 37x62x30/39   | 1715    | 1805                  | 1895   | 1985   | 2075                             | 2165                      | 1295   | 1360     | 1425      |
| 174 DOUBLE LOUNGE CHAIR RIGHT ARM      | 37x62x30/39   | 1715    | 1805                  | 1895   | 1985   | 2075                             | 2165                      | 1295   | 1360     | 1425      |
| 175 DOUBLE CHAIR LEFT ARM              | 37x40x30/39   | 1440    | 1515                  | 1590   | 1665   | 1740                             | 1815                      | 1080   | 1140     | 1200      |
| 176 DOUBLE CHAIR RIGHT ARM             | 37x40x30/39   | 1440    | 1515                  | 1590   | 1665   | 1740                             | 1815                      | 1080   | 1140     | 1200      |
| 177 ARMLESS DOUBLE CHAIR               | 30,5x40x30/39 | 1150    | 1225                  | 1300   | 1375   | 1450                             | 1525                      | 880    | 940      | 1000      |
| 178 ARMLESS DOUBLE CHAIR BUMPER LEFT   | 52x40x30/39   | 1485    | 1575                  | 1665   | 1755   | 1845                             | 1935                      | 1140   | 1205     | 1270      |
| 179 ARMLESS DOUBLE CHAIR BUMPER RIGHT  | 52x40x30/39   | 1485    | 1575                  | 1665   | 1755   | 1845                             | 1935                      | 1140   | 1205     | 1270      |
| <b>CONFIGURATIONS</b>                  |               |         |                       |  |  |                                  |                           |        |          |           |
| A CONFIG (169-170)                     | 74X40X30/39   | 3610    | 3780                  | 3950   | 4120   | 4290                             | 4460                      | 2900   | 3030     | 3160      |

## CDN Price List

### MONTE-CARLO

| Description                | L x D x H     | Leather |                       |  |  |                                  |                           | Fabric |          |           |
|----------------------------|---------------|---------|-----------------------|--|--|----------------------------------|---------------------------|--------|----------|-----------|
|                            |               | 10      | 20<br>Madras<br>Softy | 30<br>Hugo<br>Fantasy<br>Illusion<br>Tucson<br>Utah<br>Vintage<br>Wild Laredo<br>Yukon | 40<br>Elegance<br>Princess<br>Santiago<br>Sensation<br>Sunset<br>Trina<br>Victoria | 50<br>Bull<br>Cassiope<br>Dublin | 60<br>Caress<br>Ultrasued | A      | B<br>COM | C<br>alta |
| B CONFIG (169-171-174)     | 105X62X30/39  | 5045    | 5285                  | 5525   | 5765   | 6005                             | 6245                      | 3985   | 4180     | 4375      |
| C CONFIG (096-055-171-170) | 111X112X30/39 | 7640    | 8005                  | 8370   | 8735   | 9100                             | 9465                      | 5975   | 6235     | 6495      |
| D CONFIG (169-171-055-179) | 112X96X30/39  | 6760    | 7095                  | 7430   | 7765   | 8100                             | 8435                      | 5320   | 5565     | 5810      |
| J CONFIG (041-042)         | 60X40X30/39   | 3410    | 3560                  | 3710   | 3860   | 4010                             | 4160                      | 2720   | 2830     | 2940      |
| K CONFIG (041-071-005)     | 84X62X30/39   | 4700    | 4890                  | 5080   | 5270   | 5460                             | 5650                      | 3685   | 3875     | 4065      |
| L CONFIG (012-055-071-042) | 97X98X30/39   | 7215    | 7535                  | 7855   | 8175   | 8495                             | 8815                      | 5630   | 5860     | 6090      |
| M CONFIG (041-071-055-089) | 98X89X30/39   | 6440    | 6755                  | 7070   | 7385   | 7700                             | 8015                      | 5075   | 5305     | 5535      |



# SPECIFICATIONS



## MONTE-CARLO

LINEA 30 Collection



Conçu et fabriqué fièrement au Canada  
Proudly designed and made in Canada

Nos produits sont fabriqués à la main et des variations mineures peuvent survenir.

Our product is hand-made and minor variations can occur.

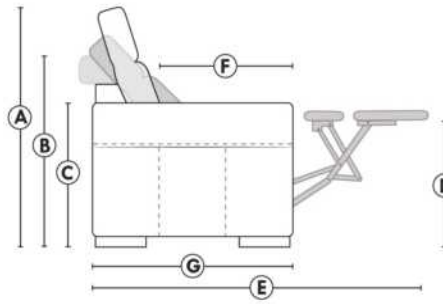

- Appui-tête levé / Headrest up
- Appui-tête baissé / Headrest down
- Complètement incliné / Fully reclined

- A** Hauteur complète 39" Total Height
- B** Hauteur appui-tête baissé 30" Height headrest down
- C** Hauteur du bras 24" Arm Height
- D** Hauteur du siège 19,5" Seat height
- E** Profondeur inclinée 63" Depth fully reclined
- F** Profondeur d'assise 20" Seat depth
- G** Profondeur appui-tête monté 37,5" Depth with headrest up

### BRAS | ARMS

Contrôle de l'inclinaison situé à l'intérieur du bras  
Recliner control located on the inside of the arm.

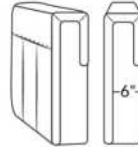

### FAUTEUIL BERÇANT PIVOTANT INCLINABLE SWIVEL ROCKING MOTION CHAIR

Dégagement mural de 16" Wall clearance  
Hauteur de 42" Height  
Largeur de bras 6" Arms width  
Option base de bois | Wood base option

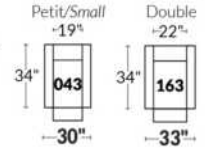

### SIÈGE 23" DE LARGE | 23" SEAT WIDTH

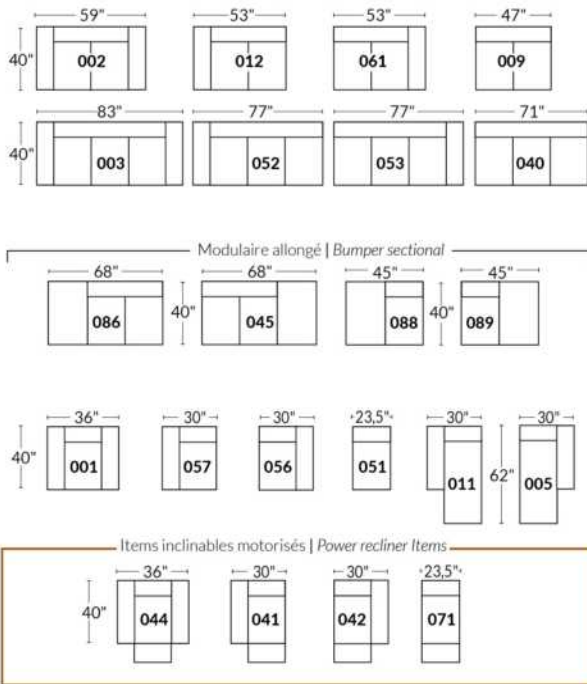

### SIÈGE 30" DE LARGE | 30" SEAT WIDTH

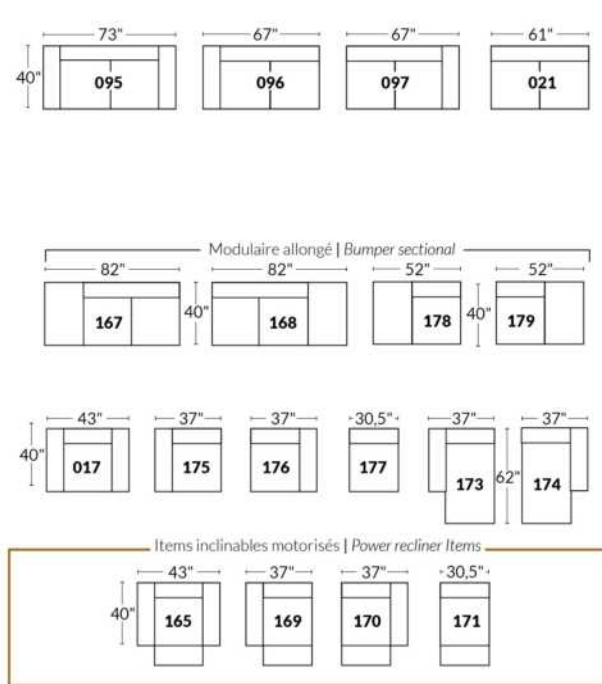

### Autres | Others

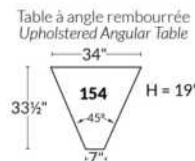
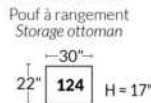
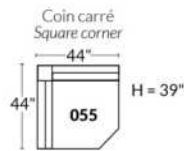

### EXEMPLE 23" EXAMPLE

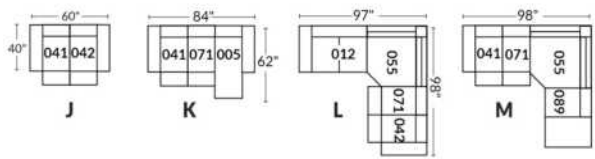

### EXEMPLE 30" EXAMPLE

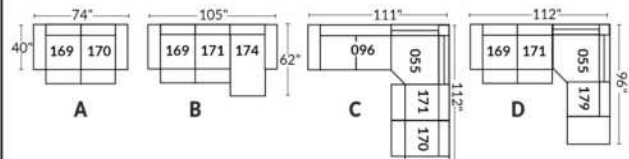

## MONTEREY

- Manual adjustable headrest on all items (2 on square corner & stationary on wedge).
- \*Wall hugger power recliners with full footrest (manual n/a).
- Power recliner lounge chair (manual n/a) with power headrest in option. Wall clearance 8" & front 5".
- Seat cushions with shaped foam + 1" layer of memory foam on top; arm with memory foam.
- Stitching: Small thread in fabric & large flat thread in leather.
- \*Excludes 043 & 163 chairs: Wall clearance 16"
- Chairs 043 & 163: arms with NO METAL insert.
- Note: 2 recliner seats separated by a corner can not be opened at the same time. No recliner seats beside #155 Small Square Corner.

### OPTIONS

- Battery Pack: Add \$160/ea.
- \*Motorized headrest: Add \$160 ea. (\*N/A on stationary items).
- Foam: Extra firm add \$15/seat.
- Choice of Large or Small 6.5" Arm: Leg on LARGE arm: LG187 wood, Metal: LG189 cyl. (Black or Chrome) or LG64 metal (sq). SMALL Arm: LG08 wood, Metal: LG196 cyl. (Black or Chrome) or LG64 (sq). Specify colour.
- Seat Depth: 20" or \*22". \*22" seat depth N/A on chairs 043 & 163.
- 043 & 163 Chairs: with wood base (specify colour).

### HOME THEATRE Configurations

- For Accessories, Cup holders & Configuration details, see Optima Home Theatre page attached.
- Accessory Dock : \$35 ea.
- Cup Holders: Metal: \$25 ea. | LED lighted Cup Holder: \$25 ea. | \*LED lighted Cup Holder with (1 or 2 motor) controls: \$40 ea.
- \*LED Light strip under seat: \$25/seat.

| Description                        | L x D x H   | Leather |                       |  |  |                                  |                           | Fabric |          |           |
|------------------------------------|-------------|---------|-----------------------|--|--|----------------------------------|---------------------------|--------|----------|-----------|
|                                    |             | 10      | 20<br>Madras<br>Softy | 30<br>Hugo<br>Fantasy<br>Illusion<br>Tucson<br>Utah<br>Vintage<br>Wild Laredo<br>Yukon | 40<br>Elegance<br>Princess<br>Santiago<br>Sensation<br>Sunset<br>Trina<br>Victoria | 50<br>Bull<br>Cassiope<br>Dublin | 60<br>Caress<br>Ultrasued | A      | B<br>COM | C<br>alta |
| 001 CHAIR                          | 43x40x33/40 | 1890    | 1980                  | 2070   | 2160   | 2250                             | 2340                      | 1535   | 1580     | 1625      |
| 002 LOVESEAT                       | 66x40x33/40 | 2700    | 2815                  | 2930   | 3045   | 3160                             | 3275                      | 2175   | 2250     | 2325      |
| 003 SOFA                           | 90x40x33/40 | 3265    | 3415                  | 3565   | 3715   | 3865                             | 4015                      | 2625   | 2715     | 2805      |
| 005 LOUNGE CHAIR RIGHT ARM         | 34x62x33/40 | 1765    | 1830                  | 1895   | 1960   | 2025                             | 2090                      | 1410   | 1470     | 1530      |
| 009 ARMLESS LOVESEAT               | 47x40x33/40 | 1895    | 1965                  | 2035   | 2105   | 2175                             | 2245                      | 1490   | 1570     | 1650      |
| 011 LOUNGE CHAIR LEFT ARM          | 34x62x33/40 | 1765    | 1830                  | 1895   | 1960   | 2025                             | 2090                      | 1410   | 1470     | 1530      |
| 012 LOVESEAT LEFT ARM              | 57x40x33/40 | 2320    | 2420                  | 2520   | 2620   | 2720                             | 2820                      | 1850   | 1925     | 2000      |
| 017 DOUBLE CHAIR                   | 50x40x33/40 | 1980    | 2080                  | 2180   | 2280   | 2380                             | 2480                      | 1600   | 1660     | 1720      |
| 021 APARTMENT SOFA NO ARM          | 61x40x33/40 | 2140    | 2240                  | 2340   | 2440   | 2540                             | 2640                      | 1670   | 1755     | 1840      |
| 040 ARMLESS SOFA                   | 71x40x33/40 | 2450    | 2565                  | 2680   | 2795   | 2910                             | 3025                      | 1950   | 2040     | 2130      |
| 041 RECLINING CHAIR LEFT ARM       | 34x40x33/40 | 1885    | 1960                  | 2035   | 2110   | 2185                             | 2260                      | 1605   | 1640     | 1675      |
| 042 RECLINING CHAIR RIGHT ARM      | 34x40x33/40 | 1885    | 1960                  | 2035   | 2110   | 2185                             | 2260                      | 1605   | 1640     | 1675      |
| 043 SWIVEL ROCKING RECLINING CHAIR | 32x34x42    | 2235    | 2345                  | 2455   | 2565   | 2675                             | 2785                      | 1875   | 1920     | 1965      |
| 044 RECLINER CHAIR                 | 43x40x33/40 | 2275    | 2365                  | 2455   | 2545   | 2635                             | 2725                      | 1920   | 1970     | 2020      |
| 045 ARMLESS LOVESEAT BUMPER RIGHT  | 68x40x33/40 | 2245    | 2340                  | 2435   | 2530   | 2625                             | 2720                      | 1785   | 1850     | 1915      |
| 050 WEDGE                          | 49x49x33    | 1645    | 1745                  | 1845   | 1945   | 2045                             | 2145                      | 1210   | 1270     | 1330      |

## MONTEREY

- Manual adjustable headrest on all items (2 on square corner & stationary on wedge).
- \*Wall hugger power recliners with full footrest (manual n/a).
- Power recliner lounge chair (manual n/a) with power headrest in option. Wall clearance 8" & front 5".
- Seat cushions with shaped foam + 1" layer of memory foam on top; arm with memory foam.
- Stitching: Small thread in fabric & large flat thread in leather.

\*Excludes 043 & 163 chairs: Wall clearance 16"

Chairs 043 & 163: arms with NO METAL insert.

Note: 2 recliner seats separated by a corner can not be opened at the same time. No recliner seats beside #155 Small Square Corner.

### OPTIONS

Battery Pack: Add \$160/ea.

\*Motorized headrest: Add \$160 ea. (\*N/A on stationary items).

Foam: Extra firm add \$15/seat.

Choice of Large or Small 6.5" Arm: Leg on LARGE arm: LG187 wood, Metal: LG189 cyl. (Black or Chrome) or LG64 metal (sq). SMALL Arm: LG08 wood, Metal: LG196 cyl. (Black or Chrome) or LG64 (sq). Specify colour.

Seat Depth: 20" or \*22". \*22" seat depth N/A on chairs 043 & 163.

043 & 163 Chairs: with wood base (specify colour).

### HOME THEATRE Configurations

For Accessories, Cup holders & Configuration details, see Optima Home Theatre page attached.

Accessory Dock : \$35 ea.

Cup Holders: Metal: \$25 ea. | LED lighted Cup Holder: \$25 ea. | \*LED lighted Cup Holder with (1 or 2 motor) controls: \$40 ea.

\*LED Light strip under seat: \$25/seat.

| Description                      | L x D x H     | Leather |                       |  |  |                                  |                            | Fabric |          |           |
|----------------------------------|---------------|---------|-----------------------|--|--|----------------------------------|----------------------------|--------|----------|-----------|
|                                  |               | 10      | 20<br>Madras<br>Softy | 30<br>Hugo<br>Fantasy<br>Illusion<br>Tucson<br>Utah<br>Vintage<br>Wild Laredo<br>Yukon | 40<br>Elegance<br>Princess<br>Santiago<br>Sensation<br>Sunset<br>Trina<br>Victoria | 50<br>Bull<br>Cassiope<br>Dublin | 60<br>Caresse<br>Ultrasued | A      | B<br>COM | C<br>alta |
| 051 ARMLESS CHAIR                | 23,5x40x33/40 | 1085    | 1135                  | 1185   | 1235   | 1285                             | 1335                       | 845    | 900      | 955       |
| 052 SOFA LEFT ARM                | 81x40x33/40   | 2870    | 3005                  | 3140   | 3275   | 3410                             | 3545                       | 2290   | 2385     | 2480      |
| 053 SOFA RIGHT ARM               | 81x40x33/40   | 2870    | 3005                  | 3140   | 3275   | 3410                             | 3545                       | 2290   | 2385     | 2480      |
| 055 SQUARE CORNER                | 44x44x33/40   | 1915    | 2010                  | 2105   | 2200   | 2295                             | 2390                       | 1510   | 1565     | 1620      |
| 056 CHAIR RIGHT ARM              | 34x40x33/40   | 1510    | 1575                  | 1640   | 1705   | 1770                             | 1835                       | 1200   | 1260     | 1320      |
| 057 CHAIR LEFT ARM               | 34x40x33/40   | 1510    | 1575                  | 1640   | 1705   | 1770                             | 1835                       | 1200   | 1260     | 1320      |
| 061 LOVESEAT RIGHT ARM           | 57x40x33/40   | 2320    | 2420                  | 2520   | 2620   | 2720                             | 2820                       | 1850   | 1925     | 2000      |
| 071 ARMLESS RECLINING CHAIR      | 23,5x40x33/40 | 1470    | 1525                  | 1580   | 1635   | 1690                             | 1745                       | 1250   | 1310     | 1370      |
| 086 ARMLESS LOVESEAT BUMPER LEFT | 68x40x33/40   | 2245    | 2340                  | 2435   | 2530   | 2625                             | 2720                       | 1785   | 1850     | 1915      |
| 088 ARMLESS CHAIR BUMPER LEFT    | 45x40x33/40   | 1440    | 1535                  | 1630   | 1725   | 1820                             | 1915                       | 1130   | 1165     | 1200      |
| 089 ARMLESS CHAIR BUMPER RIGHT   | 45x40x33/40   | 1440    | 1535                  | 1630   | 1725   | 1820                             | 1915                       | 1130   | 1165     | 1200      |
| 095 APARTMENT SOFA               | 80x40x33/40   | 2940    | 3085                  | 3230   | 3375   | 3520                             | 3665                       | 2350   | 2445     | 2540      |
| 096 APARTMENT SOFA LEFT ARM      | 71x40x33/40   | 2570    | 2680                  | 2790   | 2900   | 3010                             | 3120                       | 2020   | 2110     | 2200      |
| 097 APARTMENT SOFA RIGHT ARM     | 71x40x33/40   | 2570    | 2680                  | 2790   | 2900   | 3010                             | 3120                       | 2020   | 2110     | 2200      |
| 124 STORAGE OTTOMAN              | 30x22x17      | 745     | 765                   | 785  | 805  | 825                              | 845                        | 650    | 670      | 690       |
| 138 STRAIGHT ARM                 | 9.5x36x24     | 415     | 450                   | 485  | 520  | 555                              | 590                        | 350    | 365      | 380       |

## MONTEREY

- Manual adjustable headrest on all items (2 on square corner & stationary on wedge).
- \*Wall hugger power recliners with full footrest (manual n/a).
- Power recliner lounge chair (manual n/a) with power headrest in option. Wall clearance 8" & front 5".
- Seat cushions with shaped foam + 1" layer of memory foam on top; arm with memory foam.
- Stitching: Small thread in fabric & large flat thread in leather.
- \*Excludes 043 & 163 chairs: Wall clearance 16"
- Chairs 043 & 163: arms with NO METAL insert.
- Note: 2 recliner seats separated by a corner can not be opened at the same time. No recliner seats beside #155 Small Square Corner.

### OPTIONS

- Battery Pack: Add \$160/ea.
- \*Motorized headrest: Add \$160 ea. (\*N/A on stationary items).
- Foam: Extra firm add \$15/seat.
- Choice of Large or Small 6.5" Arm: Leg on LARGE arm: LG187 wood, Metal: LG189 cyl. (Black or Chrome) or LG64 metal (sq). SMALL Arm: LG08 wood, Metal: LG196 cyl. (Black or Chrome) or LG64 (sq). Specify colour.
- Seat Depth: 20" or \*22". \*22" seat depth N/A on chairs 043 & 163.
- 043 & 163 Chairs: with wood base (specify colour).

### HOME THEATRE Configurations

- For Accessories, Cup holders & Configuration details, see Optima Home Theatre page attached.
- Accessory Dock : \$35 ea.
- Cup Holders: Metal: \$25 ea. | LED lighted Cup Holder: \$25 ea. | \*LED lighted Cup Holder with (1 or 2 motor) controls: \$40 ea.
- \*LED Light strip under seat: \$25/seat.

| Description                            | L x D x H     | Leather |                       |  |  |                                  |                           | Fabric |          |           |
|--|---------------|---------|-----------------------|--|--|----------------------------------|---------------------------|--------|----------|-----------|
|  |               | 10      | 20<br>Madras<br>Softy | 30<br>Hugo<br>Fantasy<br>Illusion<br>Tucson<br>Utah<br>Vintage<br>Wild Laredo<br>Yukon | 40<br>Elegance<br>Princess<br>Santiago<br>Sensation<br>Sunset<br>Trina<br>Victoria | 50<br>Bull<br>Cassiope<br>Dublin | 60<br>Caress<br>Ultrasued | A      | B<br>COM | C<br>alta |
| 155 SMALL SQUARE CORNER                | 40x40x33/40   | 1915    | 2010                  | 2105   | 2200   | 2295                             | 2390                      | 1510   | 1565     | 1620      |
| 159 WEDGE STORAGE                      | 12/27x36x24   | 745     | 775                   | 805  | 835  | 865                              | 895                       | 585    | 600      | 615       |
| 160 STRAIGHT STORAGE                   | 12x36x24      | 720     | 745                   | 770  | 795  | 820                              | 845                       | 550    | 570      | 590       |
| 163 DBL SWIVEL ROCKING RECLINER CHAIR  | 35x34x42      | 2290    | 2410                  | 2530   | 2650   | 2770                             | 2890                      | 1880   | 1930     | 1980      |
| 165 DOUBLE RECLINING CHAIR             | 50x40x33/40   | 2375    | 2475                  | 2575   | 2675   | 2775                             | 2875                      | 2000   | 2065     | 2130      |
| 167 APARTMENT SOFA NO ARM BUMPER LEFT  | 82x40x33/40   | 2490    | 2620                  | 2750   | 2880   | 3010                             | 3140                      | 1960   | 2045     | 2130      |
| 168 APARTMENT SOFA NO ARM BUMPER RIGHT | 82x40x33/40   | 2490    | 2620                  | 2750   | 2880   | 3010                             | 3140                      | 1960   | 2045     | 2130      |
| 169 DOUBLE RECLINING CHAIR LEFT ARM    | 41x40x33/40   | 1990    | 2070                  | 2150   | 2230   | 2310                             | 2390                      | 1670   | 1750     | 1830      |
| 170 DOUBLE RECLINING CHAIR RIGHT ARM   | 41x40x33/40   | 1990    | 2070                  | 2150   | 2230   | 2310                             | 2390                      | 1670   | 1750     | 1830      |
| 171 ARMLESS DOUBLE RECLINING CHAIR     | 30,5x40x33/40 | 1575    | 1625                  | 1675   | 1725   | 1775                             | 1825                      | 1320   | 1380     | 1440      |
| 173 DOUBLE LOUNGE CHAIR LEFT ARM       | 41x62x33/40   | 1915    | 2005                  | 2095   | 2185   | 2275                             | 2365                      | 1535   | 1615     | 1695      |
| 174 DOUBLE LOUNGE CHAIR RIGHT ARM      | 41x62x33/40   | 1915    | 2005                  | 2095   | 2185   | 2275                             | 2365                      | 1535   | 1615     | 1695      |
| 175 DOUBLE CHAIR LEFT ARM              | 41x40x33/40   | 1590    | 1680                  | 1770   | 1860   | 1950                             | 2040                      | 1285   | 1350     | 1415      |
| 176 DOUBLE CHAIR RIGHT ARM             | 41x40x33/40   | 1590    | 1680                  | 1770   | 1860   | 1950                             | 2040                      | 1285   | 1350     | 1415      |
| 177 ARMLESS DOUBLE CHAIR               | 30,5x40x33/40 | 1185    | 1250                  | 1315   | 1380   | 1445                             | 1510                      | 915    | 970      | 1025      |
| 178 ARMLESS DOUBLE CHAIR BUMPER LEFT   | 52x40x33/40   | 1545    | 1625                  | 1705   | 1785   | 1865                             | 1945                      | 1230   | 1290     | 1350      |

## MONTEREY

- Manual adjustable headrest on all items (2 on square corner & stationary on wedge).
- \*Wall hugger power recliners with full footrest (manual n/a).
- Power recliner lounge chair (manual n/a) with power headrest in option. Wall clearance 8" & front 5".
- Seat cushions with shaped foam + 1" layer of memory foam on top; arm with memory foam.
- Stitching: Small thread in fabric & large flat thread in leather.
- \*Excludes 043 & 163 chairs: Wall clearance 16"
- Chairs 043 & 163: arms with NO METAL insert.
- Note: 2 recliner seats separated by a corner can not be opened at the same time. No recliner seats beside #155 Small Square Corner.

### OPTIONS

Battery Pack: Add \$160/ea.

\*Motorized headrest: Add \$160 ea. (\*N/A on stationary items).

Foam: Extra firm add \$15/seat.

Choice of Large or Small 6.5" Arm: Leg on LARGE arm: LG187 wood, Metal: LG189 cyl. (Black or Chrome) or LG64 metal (sq). SMALL Arm: LG08 wood, Metal: LG196 cyl. (Black or Chrome) or LG64 (sq). Specify colour.

Seat Depth: 20" or \*22". \*22" seat depth N/A on chairs 043 & 163.

043 & 163 Chairs: with wood base (specify colour).

### HOME THEATRE Configurations

For Accessories, Cup holders & Configuration details, see Optima Home Theatre page attached.

Accessory Dock : \$35 ea.

Cup Holders: Metal: \$25 ea. | LED lighted Cup Holder: \$25 ea. | \*LED lighted Cup Holder with (1 or 2 motor) controls: \$40 ea.

\*LED Light strip under seat: \$25/seat.

| Description                            | L x D x H       | Leather |                       |  |  |                                  |                           | Fabric |          |           |
|--|-----------------|---------|-----------------------|--|--|----------------------------------|---------------------------|--------|----------|-----------|
|  |                 | 10      | 20<br>Madras<br>Softy | 30<br>Hugo<br>Fantasy<br>Illusion<br>Tucson<br>Utah<br>Vintage<br>Wild Laredo<br>Yukon | 40<br>Elegance<br>Princess<br>Santiago<br>Sensation<br>Sunset<br>Trina<br>Victoria | 50<br>Bull<br>Cassiope<br>Dublin | 60<br>Caress<br>Ultrasued | A      | B<br>COM | C<br>alta |
| 179 ARMLESS DOUBLE CHAIR BUMPER RIGHT  | 52x40x33/40     | 1545    | 1625                  | 1705   | 1785   | 1865                             | 1945                      | 1230   | 1290     | 1350      |
| 186 ARMLESS LOVESEAT BUMPER STORAGE-L  | 68x40x33/40     | 2420    | 2500                  | 2580   | 2660   | 2740                             | 2820                      | 1950   | 2015     | 2080      |
| 187 ARMLESS LOVESEAT BUMPER STORAGE-R  | 68x40x33/40     | 2420    | 2500                  | 2580   | 2660   | 2740                             | 2820                      | 1950   | 2015     | 2080      |
| 188 ARMLESS CHAIR BUMPER STORAGE-L     | 45x40x33/40     | 1600    | 1690                  | 1780   | 1870   | 1960                             | 2050                      | 1295   | 1330     | 1365      |
| 189 ARMLESS CHAIR BUMPER STORAGE-R     | 45x40x33/40     | 1600    | 1690                  | 1780   | 1870   | 1960                             | 2050                      | 1295   | 1330     | 1365      |
| 190 SMALL WEDGE STORAGE                | 12/21x36x24     | 720     | 745                   | 770  | 795  | 820                              | 845                       | 550    | 570      | 590       |
| 221 ARMLESS DBL CHAIR BUMPER STORAGE-L | 52x40x33/40     | 1705    | 1790                  | 1875   | 1960   | 2045                             | 2130                      | 1390   | 1450     | 1510      |
| 222 ARMLESS DBL CHAIR BUMPER STORAGE-R | 52x40x33/40     | 1705    | 1790                  | 1875   | 1960   | 2045                             | 2130                      | 1390   | 1450     | 1510      |
| 223 APT SOFA NO ARM BUMPER STORAGE-L   | 82x40x33/40     | 2655    | 2785                  | 2915   | 3045   | 3175                             | 3305                      | 2120   | 2215     | 2310      |
| 224 APT SOFA NO ARM BUMPER STORAGE-R   | 82x40x33/40     | 2655    | 2785                  | 2915   | 3045   | 3175                             | 3305                      | 2120   | 2215     | 2310      |
| 236 RECLINING LOUNGE CHAIR LEFT ARM    | 34x62x33/40     | 2160    | 2225                  | 2290   | 2355   | 2420                             | 2485                      | 1820   | 1880     | 1940      |
| 237 RECLINING LOUNGE CHAIR RIGHT ARM   | 34x62x33/40     | 2160    | 2225                  | 2290   | 2355   | 2420                             | 2485                      | 1820   | 1880     | 1940      |
| 238 RECLINING DBL LOUNGE CHAIR L-ARM   | 41x62x33/40     | 2315    | 2405                  | 2495   | 2585   | 2675                             | 2765                      | 1940   | 2020     | 2100      |
| 239 RECLINING DBL LOUNGE CHAIR R-ARM   | 41x62x33/40     | 2315    | 2405                  | 2495   | 2585   | 2675                             | 2765                      | 1940   | 2020     | 2100      |
| V51 WINE GLASS HOLDER                  | 3.5 x 5.5 x 6.5 | 35      | 35                    | 35   | 35   | 35                               | 35                        | 35     | 35       | 35        |
| V52 PLASTIC SWIVEL TRAY                | 13 3/8 x 9 5/8  | 35      | 35                    | 35   | 35   | 35                               | 35                        | 35     | 35       | 35        |

## MONTEREY

- Manual adjustable headrest on all items (2 on square corner & stationary on wedge).
- \*Wall hugger power recliners with full footrest (manual n/a).
- Power recliner lounge chair (manual n/a) with power headrest in option. Wall clearance 8" & front 5".
- Seat cushions with shaped foam + 1" layer of memory foam on top; arm with memory foam.
- Stitching: Small thread in fabric & large flat thread in leather.
- \*Excludes 043 & 163 chairs: Wall clearance 16"
- Chairs 043 & 163: arms with NO METAL insert.
- Note: 2 recliner seats separated by a corner can not be opened at the same time. No recliner seats beside #155 Small Square Corner.

### OPTIONS

- Battery Pack: Add \$160/ea.
- \*Motorized headrest: Add \$160 ea. (\*N/A on stationary items).
- Foam: Extra firm add \$15/seat.
- Choice of Large or Small 6.5" Arm: Leg on LARGE arm: LG187 wood, Metal: LG189 cyl. (Black or Chrome) or LG64 metal (sq). SMALL Arm: LG08 wood, Metal: LG196 cyl. (Black or Chrome) or LG64 (sq). Specify colour.
- Seat Depth: 20" or \*22". \*22" seat depth N/A on chairs 043 & 163.
- 043 & 163 Chairs: with wood base (specify colour).

### HOME THEATRE Configurations

- For Accessories, Cup holders & Configuration details, see Optima Home Theatre page attached.
- Accessory Dock : \$35 ea.
- Cup Holders: Metal: \$25 ea. | LED lighted Cup Holder: \$25 ea. | \*LED lighted Cup Holder with (1 or 2 motor) controls: \$40 ea.
- \*LED Light strip under seat: \$25/seat.

| Description                 | L x D x H          | Leather |                       |  |  |                                  |                           | Fabric |          |           |
|-----------------------------|--------------------|---------|-----------------------|--|--|----------------------------------|---------------------------|--------|----------|-----------|
|                             |                    | 10      | 20<br>Madras<br>Softy | 30<br>Hugo<br>Fantasy<br>Illusion<br>Tucson<br>Utah<br>Vintage<br>Wild Laredo<br>Yukon | 40<br>Elegance<br>Princess<br>Santiago<br>Sensation<br>Sunset<br>Trina<br>Victoria | 50<br>Bull<br>Cassiope<br>Dublin | 60<br>Caress<br>Ultrasued | A      | B<br>COM | C<br>alta |
| V53 WOOD SWIVEL TRAY        | 19 x 10            | 60      | 60                    | 60   | 60   | 60                               | 60                        | 60     | 60       | 60        |
| V54 TABLET HOLDER           | 4.5 x 8 x 10       | 40      | 40                    | 40   | 40   | 40                               | 40                        | 40     | 40       | 40        |
| V55 LED LAMP                | 1.5x5x14 plié/bent | 35      | 35                    | 35   | 35   | 35                               | 35                        | 35     | 35       | 35        |
| <b>CONFIGURATIONS</b>       |                    |         |                       |  |  |                                  |                           |        |          |           |
| _A CONFIG (169-170)         | 80X40X40           | 3980    | 4140                  | 4300   | 4460   | 4620                             | 4780                      | 3340   | 3500     | 3660      |
| _B CONFIG (169-171-174)     | 111X62X40          | 5480    | 5700                  | 5920   | 6140   | 6360                             | 6580                      | 4525   | 4745     | 4965      |
| _C CONFIG (096-055-171-170) | 115X115X40         | 8050    | 8385                  | 8720   | 9055   | 9390                             | 9725                      | 6520   | 6805     | 7090      |
| _D CONFIG (169-171-055-179) | 115X96X40          | 7025    | 7330                  | 7635   | 7940   | 8245                             | 8550                      | 5730   | 5985     | 6240      |
| _J CONFIG (041-042)         | 66X40X40           | 3770    | 3920                  | 4070   | 4220   | 4370                             | 4520                      | 3210   | 3280     | 3350      |
| _K CONFIG (041-071-005)     | 90X62X40           | 5120    | 5315                  | 5510   | 5705   | 5900                             | 6095                      | 4265   | 4420     | 4575      |
| _L CONFIG (012-055-071-042) | 101X101X40         | 7590    | 7915                  | 8240   | 8565   | 8890                             | 9215                      | 6215   | 6440     | 6665      |
| _M CONFIG (041-071-055-089) | 101X89X40          | 6710    | 7030                  | 7350   | 7670   | 7990                             | 8310                      | 5495   | 5680     | 5865      |



# MONTEREY

**OPTIMA**  
Collection

**Jaymar**

Conçu et fabriqué fièrement au Canada  
Proudly designed and made in Canada

Nos produits sont fabriqués à la main et  
des variations mineures peuvent survenir

Our product is hand-made and minor variations can occur.

## SPECIFICATIONS

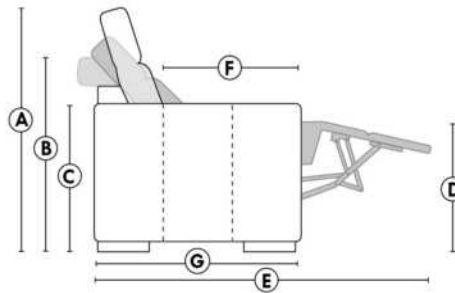

- Appui-tête levé / Headrest up
- Appui-tête baissé / Headrest down
- Complètement incliné / Fully reclined

- A** Hauteur complète 40" Total Height
- B** Hauteur appui-tête baissé 33" Height headrest down
- C** Hauteur du bras 24" Arm Height
- D** Hauteur du siège 19,5" Seat height
- E** Profondeur inclinée 65" Depth fully reclined
- F** Profondeur d'assise 20" ou/ou 22" Seat depth
- G** Profondeur appui-tête monté 37,5" Depth with headrest up

## BRAS | ARMS

Option de bras:  
Bras Régulier Large 9,5" ou Petit bras 6,5"

Arm option  
Regular arm Large 9,5" or Small arm 6,5"

Contrôle de l'inclinaison situé à l'intérieur du bras  
Recliner control located on the inside of the arm.

Option d'accessoires disponible sur  
le bras régulier seulement  
Accessories option, available on Regular arms ONLY.

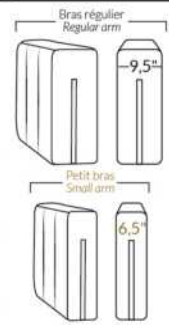

## FAUTEUIL BERÇANT PIVOTANT INCLINABLE SWIVEL ROCKING MOTION CHAIR

Dégagement mural de 16" Wall clearance  
Hauteur de 42" Height  
Largeur de bras 6" Arms width  
Option base de bois | Wood base option

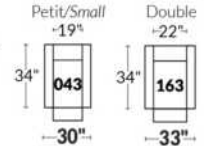

## SIÈGE 23" DE LARGE | 23" SEAT WIDTH

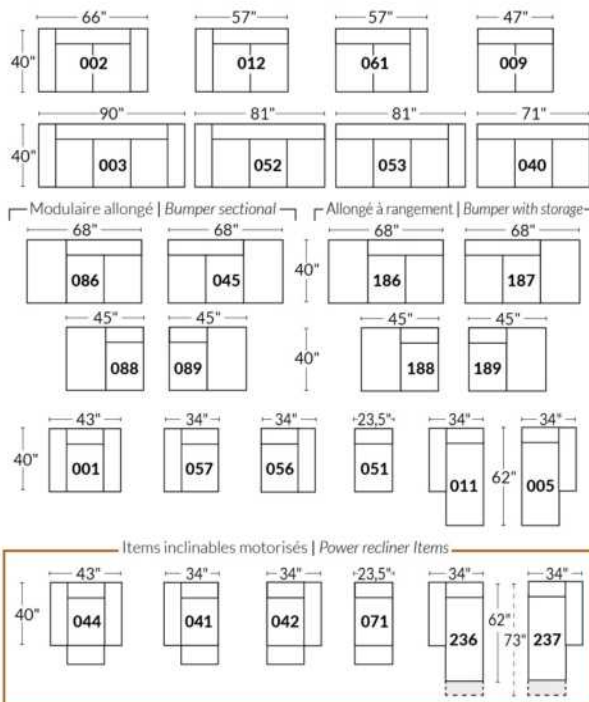

## SIÈGE 30" DE LARGE | 30" SEAT WIDTH

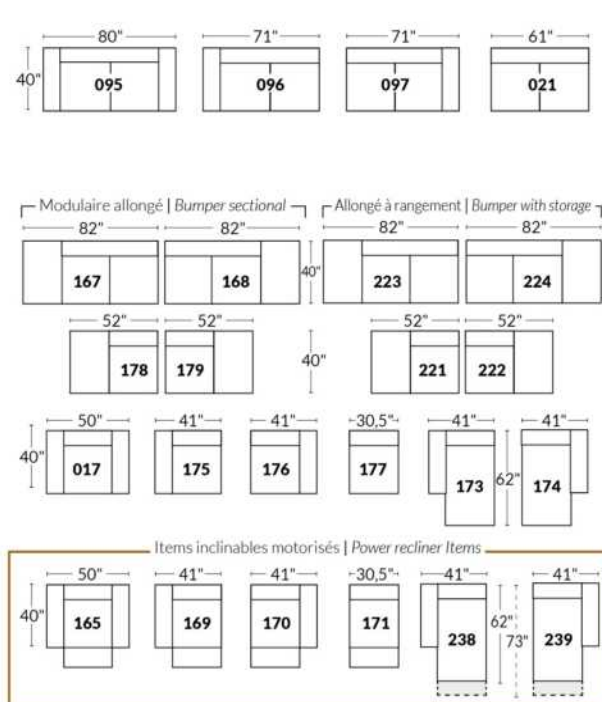

### Autres | Others

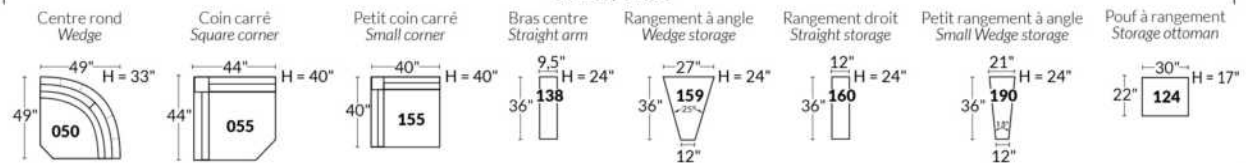

### EXEMPLE 23" EXAMPLE

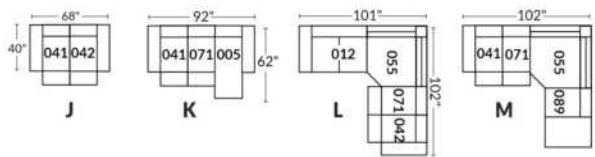

### EXEMPLE 30" EXAMPLE

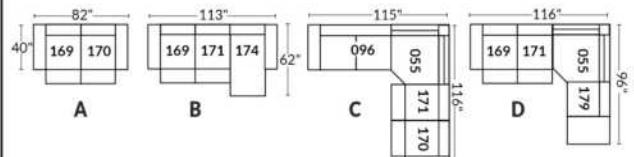



\*Available on certain models and on large arms ONLY.

### OPTIONS CUP HOLDERS

#### METAL



Silver



Matte Black



Brown

#### ILLUMINATED

1.



LED Lighted Cup holder

2.



LED Lighted Cup holder with Single Motor Control, USB Port and LED Base rail

3.



LED Lighted Cup holder with Dual Motor Control, USB Port and LED Base rail

Our illuminated one or two-control cup holders are compatible with LED lights under the seat. You can control the light on the cup holder. The 2 motor cup holder has a reset (home) button control to close your recliner back to its starting position.

#### LED Light under seat (Optional)

Available only in configurations with a minimum of 1 illuminated motorized cup holder with control buttons. The "light" button will control the opening and closing of the light.

For cup holder prices see description section of the Optima model price list.

Please provide us with a drawing of your configuration which indicates the cup holder type and its positioning.

#### Cup holder with controller:

It is important to specify the placement of the cups; on left arm or right arm and which recliner they will control. If you have a row of several seats with cup holders, by default, the controls will be on the left arms and on the right arm for the last outer chair.

#### EXAMPLE A:

041-169: Controller and cup holder on the left arm

071-171: hidden touch sensor buttons on side of seat

042-170: Controller and cup holder on right arm



#### EXAMPLE B:

071-171: These two items can be connected to a smart cup holder which will control the recliner. You must then use one of these items: 138,159, 160 and 190



#### Informations about headrest, controller on reclining seat

#### WITH illuminated cup holder

If you have a **stationary item**, you will have cup holder N°1.

If you have a recliner chair with a **manual headrest**, you will have the cup holder N°2.

If you have a recliner chair with an **electric headrest**, you will have cup holder N°3.

#### Without cup holder and with a reclining seat

If you have a recliner with a **manual headrest** you will have the touch sensor button control on the side of the seat.

If you have a recliner with an **electric headrest** you will have a dual push button controller with USB port on the arm.

If you have an **armless recliner**, you will have the hidden touch sensor button control.



Hidden touch sensor



Dual push button



# OPTIMA

## HOME THEATRE Configurations

\*Available on certain models and on large arms ONLY.

OPTIONS

### ACCESSORIES

Accessory Dock



V51 Wine Glass Holder



V52 Plastic Swivel Tray Table



V53 Wood Swivel tray Table  
(Choice of 8 colors)



Specify on which arm (left or right) the tray table will be installed.

V54 Tablet Holder



V55 LED Lamp



(For Accessory Dock price, see description section of the Optima model price list and for Accessory item prices, see at very end of the price list)

### Items 138-159-160-190 and large arm.

Accessory docks and cups are Optional. \*Not available on small arms\*

Please specify on which arms you want the accessory docks and cup holders.

NB: Item 138-159-160-190 are unfinished on the sides, must be used between 2 seats.

Each storage item has 2 USB ports and one electrical outlet inside the storage.



### SUGGESTED CONFIGURATIONS

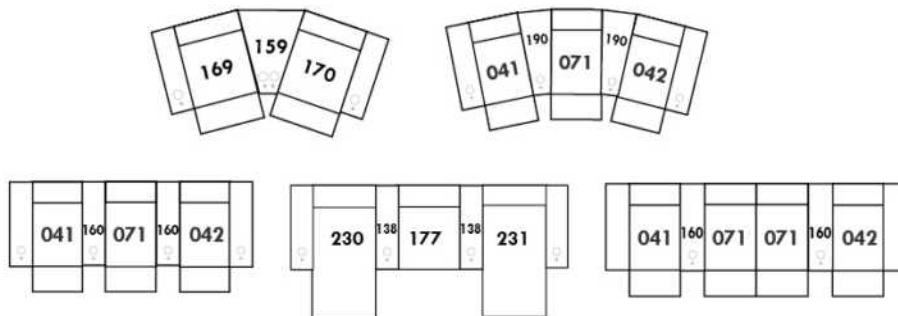

## MONTREAL

### FEATURES:

- Manual adjustable headrest on all items (stationary on wedge).
- \*Wall hugger power recliners with full footrest (manual n/a).
- Power recliner lounge chair (manual n/a) with power headrest in option. Wall clearance 8" & front 5".
- Seat cushions with shaped foam + 1" layer of memory foam on top; arm with memory foam.
- Stitching: Small thread in fabric & large flat thread in leather.
- \*Excludes 043 & 163 chairs: Wall clearance 16"

Note: 2 recliner seats separated by a corner can not be opened at the same time. No recliner seats beside #155 Small Square Corner.

### OPTIONS

- Battery Pack: Add \$160/ea.
- \*Motorized headrest: Add \$160 ea. (\*N/A on stationary items).
- Foam: Extra firm add \$15/seat.
- Choice of Large or Small 6" Arm: Leg on LARGE arm: LG187 wood or Metal: LG189 cyl. (Black or Chrome) or LG64 (sq). SMALL Arm: LG08 wood or Metal: LG196 cyl. (Black or Chrome) or LG64 (sq). Specify colour.
- Seat Depth: 20" or \*22". \*22" seat depth N/A on chairs 043 & 163.
- 043 & 163 Chairs: with wood base (specify colour).

### HOME THEATRE Configurations

For Accessories, Cup holders & Configuration details, see Optima Home Theatre page attached.

Accessory Dock : \$35 ea.

Cup Holders: Metal: \$25 ea. | LED lighted Cup Holder: \$25 ea. | \*LED lighted Cup Holder with (1 or 2 motor) controls: \$40 ea.

\*LED Light strip under seat: \$25/seat.

| Description                        | L x D x H   | Leather |                       |  |  |                                  |                           | Fabric |          |           |
|------------------------------------|-------------|---------|-----------------------|--|--|----------------------------------|---------------------------|--------|----------|-----------|
|                                    |             | 10      | 20<br>Madras<br>Softy | 30<br>Hugo<br>Fantasy<br>Illusion<br>Tucson<br>Utah<br>Vintage<br>Wild Laredo<br>Yukon | 40<br>Elegance<br>Princess<br>Santiago<br>Sensation<br>Sunset<br>Trina<br>Victoria | 50<br>Bull<br>Cassiope<br>Dublin | 60<br>Caress<br>Ultrasued | A      | B<br>COM | C<br>alta |
| 001 CHAIR                          | 42x40x33/40 | 1890    | 1980                  | 2070   | 2160   | 2250                             | 2340                      | 1535   | 1580     | 1625      |
| 002 LOVESEAT                       | 65x40x33/40 | 2700    | 2815                  | 2930   | 3045   | 3160                             | 3275                      | 2175   | 2250     | 2325      |
| 003 SOFA                           | 89x40x33/40 | 3265    | 3415                  | 3565   | 3715   | 3865                             | 4015                      | 2625   | 2715     | 2805      |
| 005 LOUNGE CHAIR RIGHT ARM         | 33x62x33/40 | 1765    | 1830                  | 1895   | 1960   | 2025                             | 2090                      | 1410   | 1470     | 1530      |
| 009 ARMLESS LOVESEAT               | 47x40x33/40 | 1895    | 1965                  | 2035   | 2105   | 2175                             | 2245                      | 1490   | 1570     | 1650      |
| 011 LOUNGE CHAIR LEFT ARM          | 33x62x33/40 | 1765    | 1830                  | 1895   | 1960   | 2025                             | 2090                      | 1410   | 1470     | 1530      |
| 012 LOVESEAT LEFT ARM              | 56x40x33/40 | 2320    | 2420                  | 2520   | 2620   | 2720                             | 2820                      | 1850   | 1925     | 2000      |
| 017 DOUBLE CHAIR                   | 49x40x33/40 | 1980    | 2080                  | 2180   | 2280   | 2380                             | 2480                      | 1600   | 1660     | 1720      |
| 021 APARTMENT SOFA NO ARM          | 61x40x33/40 | 2140    | 2240                  | 2340   | 2440   | 2540                             | 2640                      | 1670   | 1755     | 1840      |
| 040 ARMLESS SOFA                   | 71x40x33/40 | 2450    | 2565                  | 2680   | 2795   | 2910                             | 3025                      | 1950   | 2040     | 2130      |
| 041 RECLINING CHAIR LEFT ARM       | 33x40x33/40 | 1885    | 1960                  | 2035   | 2110   | 2185                             | 2260                      | 1605   | 1640     | 1675      |
| 042 RECLINING CHAIR RIGHT ARM      | 33x40x33/40 | 1885    | 1960                  | 2035   | 2110   | 2185                             | 2260                      | 1605   | 1640     | 1675      |
| 043 SWIVEL ROCKING RECLINING CHAIR | 30x34x42    | 2235    | 2345                  | 2455   | 2565   | 2675                             | 2785                      | 1875   | 1920     | 1965      |
| 044 RECLINER CHAIR                 | 42x40x33/40 | 2275    | 2365                  | 2455   | 2545   | 2635                             | 2725                      | 1920   | 1970     | 2020      |
| 045 ARMLESS LOVESEAT BUMPER RIGHT  | 68x40x33/40 | 2245    | 2340                  | 2435   | 2530   | 2625                             | 2720                      | 1785   | 1850     | 1915      |
| 050 WEDGE                          | 49x49x33    | 1645    | 1745                  | 1845   | 1945   | 2045                             | 2145                      | 1210   | 1270     | 1330      |

## MONTREAL

### FEATURES:

- Manual adjustable headrest on all items (stationary on wedge).
- \*Wall hugger power recliners with full footrest (manual n/a).
- Power recliner lounge chair (manual n/a) with power headrest in option. Wall clearance 8" & front 5".
- Seat cushions with shaped foam + 1" layer of memory foam on top; arm with memory foam.
- Stitching: Small thread in fabric & large flat thread in leather.
- \*Excludes 043 & 163 chairs: Wall clearance 16"

Note: 2 recliner seats separated by a corner can not be opened at the same time. No recliner seats beside #155 Small Square Corner.

### OPTIONS

- Battery Pack: Add \$160/ea.
- \*Motorized headrest: Add \$160 ea. (\*N/A on stationary items).
- Foam: Extra firm add \$15/seat.
- Choice of Large or Small 6" Arm: Leg on LARGE arm: LG187 wood or Metal: LG189 cyl. (Black or Chrome) or LG64 (sq). SMALL Arm: LG08 wood or Metal: LG196 cyl. (Black or Chrome) or LG64 (sq). Specify colour.
- Seat Depth: 20" or \*22". \*22" seat depth N/A on chairs 043 & 163.
- 043 & 163 Chairs: with wood base (specify colour).

### HOME THEATRE Configurations

For Accessories, Cup holders & Configuration details, see Optima Home Theatre page attached.

Accessory Dock : \$35 ea.

Cup Holders: Metal: \$25 ea. | LED lighted Cup Holder: \$25 ea. | \*LED lighted Cup Holder with (1 or 2 motor) controls: \$40 ea.

\*LED Light strip under seat: \$25/seat.

| Description                      | L x D x H     | Leather |                       |  |  |                                  |                            | Fabric |          |           |
|----------------------------------|---------------|---------|-----------------------|--|--|----------------------------------|----------------------------|--------|----------|-----------|
|                                  |               | 10      | 20<br>Madras<br>Softy | 30<br>Hugo<br>Fantasy<br>Illusion<br>Tucson<br>Utah<br>Vintage<br>Wild Laredo<br>Yukon | 40<br>Elegance<br>Princess<br>Santiago<br>Sensation<br>Sunset<br>Trina<br>Victoria | 50<br>Bull<br>Cassiope<br>Dublin | 60<br>Caresse<br>Ultrasued | A      | B<br>COM | C<br>alta |
| 051 ARMLESS CHAIR                | 23,5x40x33/40 | 1085    | 1135                  | 1185   | 1235   | 1285                             | 1335                       | 845    | 900      | 955       |
| 052 SOFA LEFT ARM                | 80x40x33/40   | 2870    | 3005                  | 3140   | 3275   | 3410                             | 3545                       | 2290   | 2385     | 2480      |
| 053 SOFA RIGHT ARM               | 80x40x33/40   | 2870    | 3005                  | 3140   | 3275   | 3410                             | 3545                       | 2290   | 2385     | 2480      |
| 055 SQUARE CORNER                | 44x44x33/40   | 1915    | 2010                  | 2105   | 2200   | 2295                             | 2390                       | 1510   | 1565     | 1620      |
| 056 CHAIR RIGHT ARM              | 33x40x33/40   | 1510    | 1575                  | 1640   | 1705   | 1770                             | 1835                       | 1200   | 1260     | 1320      |
| 057 CHAIR LEFT ARM               | 33x40x33/40   | 1510    | 1575                  | 1640   | 1705   | 1770                             | 1835                       | 1200   | 1260     | 1320      |
| 061 LOVESEAT RIGHT ARM           | 56x40x33/40   | 2320    | 2420                  | 2520   | 2620   | 2720                             | 2820                       | 1850   | 1925     | 2000      |
| 071 ARMLESS RECLINING CHAIR      | 23,5x40x33/40 | 1470    | 1525                  | 1580   | 1635   | 1690                             | 1745                       | 1250   | 1310     | 1370      |
| 086 ARMLESS LOVESEAT BUMPER LEFT | 68x40x33/40   | 2245    | 2340                  | 2435   | 2530   | 2625                             | 2720                       | 1785   | 1850     | 1915      |
| 088 ARMLESS CHAIR BUMPER LEFT    | 45x40x33/40   | 1440    | 1535                  | 1630   | 1725   | 1820                             | 1915                       | 1130   | 1165     | 1200      |
| 089 ARMLESS CHAIR BUMPER RIGHT   | 45x40x33/40   | 1440    | 1535                  | 1630   | 1725   | 1820                             | 1915                       | 1130   | 1165     | 1200      |
| 095 APARTMENT SOFA               | 79x40x33/40   | 2940    | 3085                  | 3230   | 3375   | 3520                             | 3665                       | 2350   | 2445     | 2540      |
| 096 APARTMENT SOFA LEFT ARM      | 70x40x33/40   | 2570    | 2680                  | 2790   | 2900   | 3010                             | 3120                       | 2020   | 2110     | 2200      |
| 097 APARTMENT SOFA RIGHT ARM     | 70x40x33/40   | 2570    | 2680                  | 2790   | 2900   | 3010                             | 3120                       | 2020   | 2110     | 2200      |
| 124 STORAGE OTTOMAN              | 30x22x17      | 745     | 765                   | 785  | 805  | 825                              | 845                        | 650    | 670      | 690       |
| 138 STRAIGHT ARM                 | 9x36x24       | 415     | 450                   | 485  | 520  | 555                              | 590                        | 350    | 365      | 380       |

## MONTREAL

### FEATURES:

- Manual adjustable headrest on all items (stationary on wedge).
- \*Wall hugger power recliners with full footrest (manual n/a).
- Power recliner lounge chair (manual n/a) with power headrest in option. Wall clearance 8" & front 5".
- Seat cushions with shaped foam + 1" layer of memory foam on top; arm with memory foam.
- Stitching: Small thread in fabric & large flat thread in leather.
- \*Excludes 043 & 163 chairs: Wall clearance 16"

Note: 2 recliner seats separated by a corner can not be opened at the same time. No recliner seats beside #155 Small Square Corner.

### OPTIONS

- Battery Pack: Add \$160/ea.
- \*Motorized headrest: Add \$160 ea. (\*N/A on stationary items).
- Foam: Extra firm add \$15/seat.
- Choice of Large or Small 6" Arm: Leg on LARGE arm: LG187 wood or Metal: LG189 cyl. (Black or Chrome) or LG64 (sq). SMALL Arm: LG08 wood or Metal: LG196 cyl. (Black or Chrome) or LG64 (sq). Specify colour.
- Seat Depth: 20" or \*22". \*22" seat depth N/A on chairs 043 & 163.
- 043 & 163 Chairs: with wood base (specify colour).

### HOME THEATRE Configurations

For Accessories, Cup holders & Configuration details, see Optima Home Theatre page attached.

Accessory Dock : \$35 ea.

Cup Holders: Metal: \$25 ea. | LED lighted Cup Holder: \$25 ea. | \*LED lighted Cup Holder with (1 or 2 motor) controls: \$40 ea.

\*LED Light strip under seat: \$25/seat.

| Description                            | L x D x H     | Leather |                       |  |  |                                  |                           | Fabric |          |           |
|--|---------------|---------|-----------------------|--|--|----------------------------------|---------------------------|--------|----------|-----------|
|  |               | 10      | 20<br>Madras<br>Softy | 30<br>Hugo<br>Fantasy<br>Illusion<br>Tucson<br>Utah<br>Vintage<br>Wild Laredo<br>Yukon | 40<br>Elegance<br>Princess<br>Santiago<br>Sensation<br>Sunset<br>Trina<br>Victoria | 50<br>Bull<br>Cassiope<br>Dublin | 60<br>Caress<br>Ultrasued | A      | B<br>COM | C<br>alta |
| 155 SMALL SQUARE CORNER                | 40x40x33/40   | 1915    | 2010                  | 2105   | 2200   | 2295                             | 2390                      | 1510   | 1565     | 1620      |
| 159 WEDGE STORAGE                      | 12/27x36x24   | 745     | 775                   | 805  | 835  | 865                              | 895                       | 585    | 600      | 615       |
| 160 STRAIGHT STORAGE                   | 12x36x24      | 720     | 745                   | 770  | 795  | 820                              | 845                       | 550    | 570      | 590       |
| 163 DBL SWIVEL ROCKING RECLINER CHAIR  | 33x34x42      | 2290    | 2410                  | 2530   | 2650   | 2770                             | 2890                      | 1880   | 1930     | 1980      |
| 165 DOUBLE RECLINING CHAIR             | 49x40x33/40   | 2375    | 2475                  | 2575   | 2675   | 2775                             | 2875                      | 2000   | 2065     | 2130      |
| 167 APARTMENT SOFA NO ARM BUMPER LEFT  | 82x40x33/40   | 2490    | 2620                  | 2750   | 2880   | 3010                             | 3140                      | 1960   | 2045     | 2130      |
| 168 APARTMENT SOFA NO ARM BUMPER RIGHT | 82x40x33/40   | 2490    | 2620                  | 2750   | 2880   | 3010                             | 3140                      | 1960   | 2045     | 2130      |
| 169 DOUBLE RECLINING CHAIR LEFT ARM    | 40x40x33/40   | 1990    | 2070                  | 2150   | 2230   | 2310                             | 2390                      | 1670   | 1750     | 1830      |
| 170 DOUBLE RECLINING CHAIR RIGHT ARM   | 40x40x33/40   | 1990    | 2070                  | 2150   | 2230   | 2310                             | 2390                      | 1670   | 1750     | 1830      |
| 171 ARMLESS DOUBLE RECLINING CHAIR     | 30,5x40x33/40 | 1575    | 1625                  | 1675   | 1725   | 1775                             | 1825                      | 1320   | 1380     | 1440      |
| 173 DOUBLE LOUNGE CHAIR LEFT ARM       | 40x62x33/40   | 1915    | 2005                  | 2095   | 2185   | 2275                             | 2365                      | 1535   | 1615     | 1695      |
| 174 DOUBLE LOUNGE CHAIR RIGHT ARM      | 40x62x33/40   | 1915    | 2005                  | 2095   | 2185   | 2275                             | 2365                      | 1535   | 1615     | 1695      |
| 175 DOUBLE CHAIR LEFT ARM              | 40x40x33/40   | 1590    | 1680                  | 1770   | 1860   | 1950                             | 2040                      | 1285   | 1350     | 1415      |
| 176 DOUBLE CHAIR RIGHT ARM             | 40x40x33/40   | 1590    | 1680                  | 1770   | 1860   | 1950                             | 2040                      | 1285   | 1350     | 1415      |
| 177 ARMLESS DOUBLE CHAIR               | 30,5x40x33/40 | 1185    | 1250                  | 1315   | 1380   | 1445                             | 1510                      | 915    | 970      | 1025      |
| 178 ARMLESS DOUBLE CHAIR BUMPER LEFT   | 52x40x33/40   | 1545    | 1625                  | 1705   | 1785   | 1865                             | 1945                      | 1230   | 1290     | 1350      |

## MONTREAL

### FEATURES:

- Manual adjustable headrest on all items (stationary on wedge).
- \*Wall hugger power recliners with full footrest (manual n/a).
- Power recliner lounge chair (manual n/a) with power headrest in option. Wall clearance 8" & front 5".
- Seat cushions with shaped foam + 1" layer of memory foam on top; arm with memory foam.
- Stitching: Small thread in fabric & large flat thread in leather.
- \*Excludes 043 & 163 chairs: Wall clearance 16"

Note: 2 recliner seats separated by a corner can not be opened at the same time. No recliner seats beside #155 Small Square Corner.

### OPTIONS

- Battery Pack: Add \$160/ea.
- \*Motorized headrest: Add \$160 ea. (\*N/A on stationary items).
- Foam: Extra firm add \$15/seat.
- Choice of Large or Small 6" Arm: Leg on LARGE arm: LG187 wood or Metal: LG189 cyl. (Black or Chrome) or LG64 (sq). SMALL Arm: LG08 wood or Metal: LG196 cyl. (Black or Chrome) or LG64 (sq). Specify colour.
- Seat Depth: 20" or \*22". \*22" seat depth N/A on chairs 043 & 163.
- 043 & 163 Chairs: with wood base (specify colour).

### HOME THEATRE Configurations

For Accessories, Cup holders & Configuration details, see Optima Home Theatre page attached.

Accessory Dock : \$35 ea.

Cup Holders: Metal: \$25 ea. | LED lighted Cup Holder: \$25 ea. | \*LED lighted Cup Holder with (1 or 2 motor) controls: \$40 ea.

\*LED Light strip under seat: \$25/seat.

| Description                            | L x D x H       | Leather |                       |  |  |                                  |                           | Fabric |          |           |
|--|-----------------|---------|-----------------------|--|--|----------------------------------|---------------------------|--------|----------|-----------|
|  |                 | 10      | 20<br>Madras<br>Softy | 30<br>Hugo<br>Fantasy<br>Illusion<br>Tucson<br>Utah<br>Vintage<br>Wild Laredo<br>Yukon | 40<br>Elegance<br>Princess<br>Santiago<br>Sensation<br>Sunset<br>Trina<br>Victoria | 50<br>Bull<br>Cassiope<br>Dublin | 60<br>Caress<br>Ultrasued | A      | B<br>COM | C<br>alta |
| 179 ARMLESS DOUBLE CHAIR BUMPER RIGHT  | 52x40x33/40     | 1545    | 1625                  | 1705   | 1785   | 1865                             | 1945                      | 1230   | 1290     | 1350      |
| 186 ARMLESS LOVESEAT BUMPER STORAGE-L  | 68x40x33/40     | 2420    | 2500                  | 2580   | 2660   | 2740                             | 2820                      | 1950   | 2015     | 2080      |
| 187 ARMLESS LOVESEAT BUMPER STORAGE-R  | 68x40x33/40     | 2420    | 2500                  | 2580   | 2660   | 2740                             | 2820                      | 1950   | 2015     | 2080      |
| 188 ARMLESS CHAIR BUMPER STORAGE-L     | 45x40x33/40     | 1600    | 1690                  | 1780   | 1870   | 1960                             | 2050                      | 1295   | 1330     | 1365      |
| 189 ARMLESS CHAIR BUMPER STORAGE-R     | 45x40x33/40     | 1600    | 1690                  | 1780   | 1870   | 1960                             | 2050                      | 1295   | 1330     | 1365      |
| 190 SMALL WEDGE STORAGE                | 12/21x36x24     | 720     | 745                   | 770  | 795  | 820                              | 845                       | 550    | 570      | 590       |
| 221 ARMLESS DBL CHAIR BUMPER STORAGE-L | 52x40x33/40     | 1705    | 1790                  | 1875   | 1960   | 2045                             | 2130                      | 1390   | 1450     | 1510      |
| 222 ARMLESS DBL CHAIR BUMPER STORAGE-R | 52x40x33/40     | 1705    | 1790                  | 1875   | 1960   | 2045                             | 2130                      | 1390   | 1450     | 1510      |
| 223 APT SOFA NO ARM BUMPER STORAGE-L   | 82x40x33/40     | 2655    | 2785                  | 2915   | 3045   | 3175                             | 3305                      | 2120   | 2215     | 2310      |
| 224 APT SOFA NO ARM BUMPER STORAGE-R   | 82x40x33/40     | 2655    | 2785                  | 2915   | 3045   | 3175                             | 3305                      | 2120   | 2215     | 2310      |
| 236 RECLINING LOUNGE CHAIR LEFT ARM    | 33x62x33/40     | 2160    | 2225                  | 2290   | 2355   | 2420                             | 2485                      | 1820   | 1880     | 1940      |
| 237 RECLINING LOUNGE CHAIR RIGHT ARM   | 33x62x33/40     | 2160    | 2225                  | 2290   | 2355   | 2420                             | 2485                      | 1820   | 1880     | 1940      |
| 238 RECLINING DBL LOUNGE CHAIR L-ARM   | 40x62x33/40     | 2315    | 2405                  | 2495   | 2585   | 2675                             | 2765                      | 1940   | 2020     | 2100      |
| 239 RECLINING DBL LOUNGE CHAIR R-ARM   | 40x62x33/40     | 2315    | 2405                  | 2495   | 2585   | 2675                             | 2765                      | 1940   | 2020     | 2100      |
| V51 WINE GLASS HOLDER                  | 3.5 x 5.5 x 6.5 | 35      | 35                    | 35   | 35   | 35                               | 35                        | 35     | 35       | 35        |
| V52 PLASTIC SWIVEL TRAY                | 13 3/8 x 9 5/8  | 35      | 35                    | 35   | 35   | 35                               | 35                        | 35     | 35       | 35        |

## MONTREAL

**FEATURES:**

- Manual adjustable headrest on all items (stationary on wedge).
- \*Wall hugger power recliners with full footrest (manual n/a).
- Power recliner lounge chair (manual n/a) with power headrest in option. Wall clearance 8" & front 5".
- Seat cushions with shaped foam + 1" layer of memory foam on top; arm with memory foam.
- Stitching: Small thread in fabric & large flat thread in leather.
- \*Excludes 043 & 163 chairs: Wall clearance 16"

Note: 2 recliner seats separated by a corner can not be opened at the same time. No recliner seats beside #155 Small Square Corner.

**OPTIONS**

- Battery Pack: Add \$160/ea.
- \*Motorized headrest: Add \$160 ea. (\*N/A on stationary items).
- Foam: Extra firm add \$15/seat.
- Choice of Large or Small 6" Arm: Leg on LARGE arm: LG187 wood or Metal: LG189 cyl. (Black or Chrome) or LG64 (sq). SMALL Arm: LG08 wood or Metal: LG196 cyl. (Black or Chrome) or LG64 (sq). Specify colour.
- Seat Depth: 20" or \*22". \*22" seat depth N/A on chairs 043 & 163.
- 043 & 163 Chairs: with wood base (specify colour).

**HOME THEATRE Configurations**

For Accessories, Cup holders & Configuration details, see Optima Home Theatre page attached.

Accessory Dock : \$35 ea.

Cup Holders: Metal: \$25 ea. | LED lighted Cup Holder: \$25 ea. | \*LED lighted Cup Holder with (1 or 2 motor) controls: \$40 ea.

\*LED Light strip under seat: \$25/seat.

| Description                 | L x D x H          | Leather |                       |  |  |                                  |                           | Fabric |          |           |
|-----------------------------|--------------------|---------|-----------------------|--|--|----------------------------------|---------------------------|--------|----------|-----------|
|                             |                    | 10      | 20<br>Madras<br>Softy | 30<br>Hugo<br>Fantasy<br>Illusion<br>Tucson<br>Utah<br>Vintage<br>Wild Laredo<br>Yukon | 40<br>Elegance<br>Princess<br>Santiago<br>Sensation<br>Sunset<br>Trina<br>Victoria | 50<br>Bull<br>Cassiope<br>Dublin | 60<br>Caress<br>Ultrasued | A      | B<br>COM | C<br>alta |
| V53 WOOD SWIVEL TRAY        | 19 x 10            | 60      | 60                    | 60   | 60   | 60                               | 60                        | 60     | 60       | 60        |
| V54 TABLET HOLDER           | 4.5 x 8 x 10       | 40      | 40                    | 40   | 40   | 40                               | 40                        | 40     | 40       | 40        |
| V55 LED LAMP                | 1.5x5x14 plié/bent | 35      | 35                    | 35   | 35   | 35                               | 35                        | 35     | 35       | 35        |
| <b>CONFIGURATIONS</b>       |                    |         |                       |  |  |                                  |                           |        |          |           |
| _A CONFIG (169-170)         | 80X40X40           | 3980    | 4140                  | 4300   | 4460   | 4620                             | 4780                      | 3340   | 3500     | 3660      |
| _B CONFIG (169-171-174)     | 111X62X40          | 5480    | 5700                  | 5920   | 6140   | 6360                             | 6580                      | 4525   | 4745     | 4965      |
| _C CONFIG (096-055-171-170) | 115X115X40         | 8050    | 8385                  | 8720   | 9055   | 9390                             | 9725                      | 6520   | 6805     | 7090      |
| _D CONFIG (169-171-055-179) | 115X96X50          | 7025    | 7330                  | 7635   | 7940   | 8245                             | 8550                      | 5730   | 5985     | 6240      |
| _J CONFIG (041-042)         | 66X40X40           | 3770    | 3920                  | 4070   | 4220   | 4370                             | 4520                      | 3210   | 3280     | 3350      |
| _K CONFIG (041-071-005)     | 90X62X40           | 5120    | 5315                  | 5510   | 5705   | 5900                             | 6095                      | 4265   | 4420     | 4575      |
| _L CONFIG (012-055-071-042) | 101X101X40         | 7590    | 7915                  | 8240   | 8565   | 8890                             | 9215                      | 6215   | 6440     | 6665      |
| _M CONFIG (041-071-055-089) | 101X89X40          | 6710    | 7030                  | 7350   | 7670   | 7990                             | 8310                      | 5495   | 5680     | 5865      |



# MONTREAL

**OPTIMA**  
Collection

**Jaymar**

Conçu et fabriqué fièrement au Canada  
Proudly designed and made in Canada

Nos produits sont fabriqués à la main et des variations mineures peuvent survenir.

Our product is hand-made and minor variations can occur.

## SPECIFICATIONS

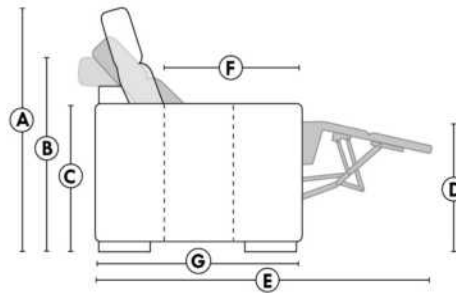

- Appui-tête levé / Headrest up
- Appui-tête baissé / Headrest down
- Complètement incliné / Fully reclined

- A** Hauteur complète 40" Total Height
- B** Hauteur appui-tête baissé 33" Height headrest down
- C** Hauteur du bras 24" Arm Height
- D** Hauteur du siège 19,5" Seat height
- E** Profondeur inclinée 65" Depth fully reclined
- F** Profondeur d'assise 20"ou/ou 22" Seat depth
- G** Profondeur appui-tête monté 37,5" Depth with headrest up

## BRAS | ARMS

Option de bras:  
Bras Régulier Large 9" ou Petit bras 6"

Arm option  
Regular arm Large 9" or Small arm 6"

Contrôle de l'inclinaison situé à l'intérieur du bras  
Recliner control located on the inside of the arm.

Option d'accessoires disponible sur le bras régulier seulement  
Accessories option, available on Regular arms ONLY.

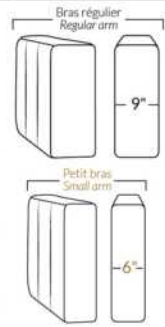

## FAUTEUIL BERÇANT PIVOTANT INCLINABLE SWIVEL ROCKING MOTION CHAIR



## SIÈGE 23" DE LARGE | 23" SEAT WIDTH

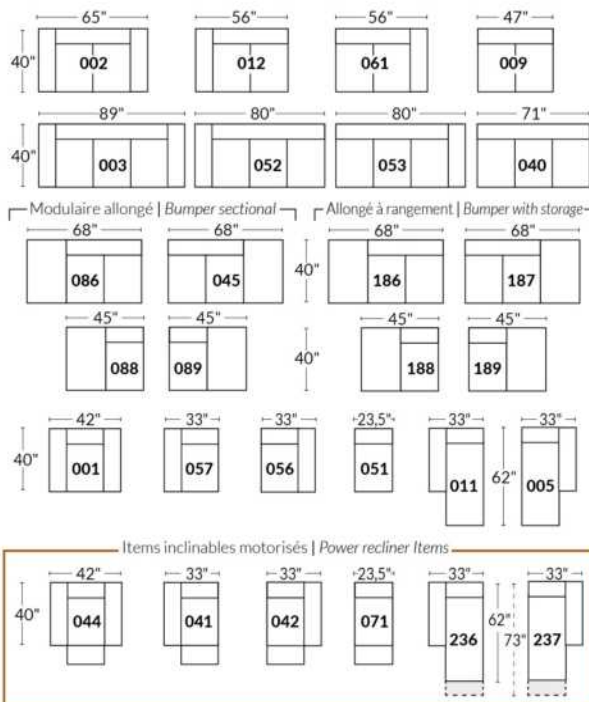

## SIÈGE 30" DE LARGE | 30" SEAT WIDTH

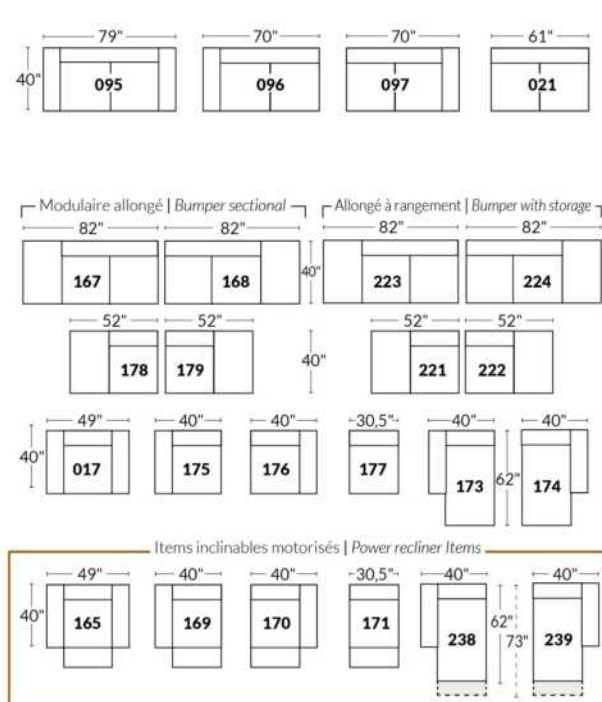

### Autres | Others

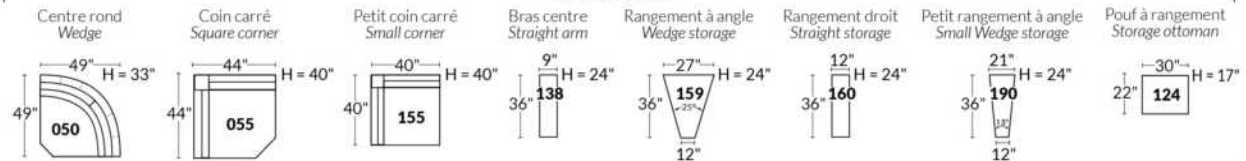

### EXEMPLE 23" EXAMPLE

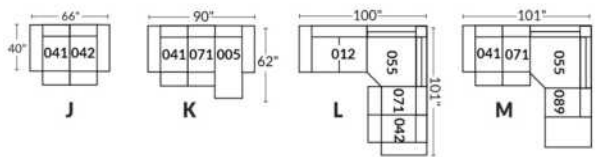

### EXEMPLE 30" EXAMPLE

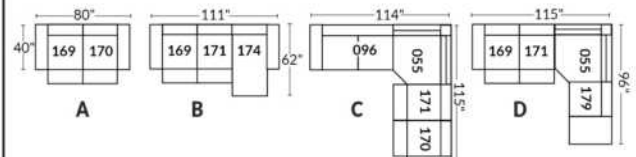



\*Available on certain models and on large arms ONLY.

### OPTIONS CUP HOLDERS

#### METAL



Silver



Matte Black



Brown

#### ILLUMINATED

1.



LED Lighted Cup holder

2.



LED Lighted Cup holder with Single Motor Control, USB Port and LED Base rail

3.



LED Lighted Cup holder with Dual Motor Control, USB Port and LED Base rail

Our illuminated one or two-control cup holders are compatible with LED lights under the seat. You can control the light on the cup holder. The 2 motor cup holder has a reset (home) button control to close your recliner back to its starting position.

#### LED Light under seat (Optional)

Available only in configurations with a minimum of 1 illuminated motorized cup holder with control buttons. The "light" button will control the opening and closing of the light.

For cup holder prices see description section of the Optima model price list.

Please provide us with a drawing of your configuration which indicates the cup holder type and its positioning.

#### Cup holder with controller:

It is important to specify the placement of the cups; on left arm or right arm and which recliner they will control. If you have a row of several seats with cup holders, by default, the controls will be on the left arms and on the right arm for the last outer chair.

#### EXAMPLE A:

041-169: Controller and cup holder on the left arm

071-171: hidden touch sensor buttons on side of seat

042-170: Controller and cup holder on right arm



#### EXAMPLE B:

071-171: These two items can be connected to a smart cup holder which will control the recliner. You must then use one of these items: 138,159, 160 and 190



#### Informations about headrest, controller on reclining seat

#### WITH illuminated cup holder

If you have a **stationary item**, you will have cup holder N°1.

If you have a recliner chair with a **manual headrest**, you will have the cup holder N°2.

If you have a recliner chair with an **electric headrest**, you will have cup holder N°3.

#### Without cup holder and with a reclining seat

If you have a recliner with a **manual headrest** you will have the touch sensor button control on the side of the seat.

If you have a recliner with an **electric headrest** you will have a dual push button controller with USB port on the arm.

If you have an **armless recliner**, you will have the hidden touch sensor button control.



Hidden touch sensor



Dual push button



# OPTIMA

## HOME THEATRE Configurations

\*Available on certain models and on large arms ONLY.

OPTIONS

### ACCESSORIES

Accessory Dock



V51 Wine Glass Holder



V52 Plastic Swivel Tray Table



V53 Wood Swivel tray Table  
(Choice of 8 colors)



Specify on which arm (left or right) the tray table will be installed.

V54 Tablet Holder



V55 LED Lamp



(For Accessory Dock price, see description section of the Optima model price list and for Accessory item prices, see at very end of the price list)

### Items 138-159-160-190 and large arm.

Accessory docks and cups are Optional. \*Not available on small arms\*

Please specify on which arms you want the accessory docks and cup holders.

NB: Item 138-159-160-190 are unfinished on the sides, must be used between 2 seats.

Each storage item has 2 USB ports and one electrical outlet inside the storage.



### SUGGESTED CONFIGURATIONS



## NATURE

**FEATURES:** The Rubix collection offers unparalleled comfort. Upholstery consists of a mixture of Canadian goose feathers with micro gel fibers and high density foam. The feather pockets are placed in 100% cotton casings to equally maintain the feathers in the cushions while minimizing feather leaks.

- All furniture pieces are finished on the sides and can be arranged as a sectional or as standalone pieces.
- Each item has a discreet fastening system that can be turned under the furniture.

**NOTE:**

- Items 27" & 30" are NOT compatible. (The depth of items 27" & 30" differ).
- Lounge Chair items 011-005 | 173-174: Comes in 2 pieces but the cushion will be 1 piece.
- In LEATHER, this model is NOT available in the following leathers: (Handle 1): Madras, Tucson, Vintage & Wild Laredo. (Handle 2): Elegance, Trina & Victoria.

**OPTIONS:**

- Roll Cushions on items (excl. Ottomans) : Available in combo (fabric or leather) at same price. Specify cover #2.
- Wooden platform - specify colour.

| Description                       | L x D x H      | Leather |                       |  |  |                                  |                           | Fabric |          |           |
|-----------------------------------|----------------|---------|-----------------------|--|--|----------------------------------|---------------------------|--------|----------|-----------|
|                                   |                | 10      | 20<br>Madras<br>Softy | 30<br>Hugo<br>Fantasy<br>Illusion<br>Tucson<br>Utah<br>Vintage<br>Wild Laredo<br>Yukon | 40<br>Elegance<br>Princess<br>Santiago<br>Sensation<br>Sunset<br>Trina<br>Victoria | 50<br>Bull<br>Cassiope<br>Dublin | 60<br>Caress<br>Ultrasued | A      | B<br>COM | C<br>alta |
| 001 CHAIR                         | 44.5x35.5x33   | 1525    | 1630                  | 1735   | 1840   | 1945                             | 2050                      | 1215   | 1265     | 1315      |
| 005 LOUNGE CHAIR RIGHT ARM        | 35.5x71x33     | 1980    | 2195                  | 2410   | 2625   | 2840                             | 3055                      | 1790   | 1885     | 1980      |
| 006 OTTOMAN                       | 27x35.5x16.5   | 705     | 810                   | 915  | 1020   | 1125                             | 1230                      | 715    | 765      | 815       |
| 011 LOUNGE CHAIR LEFT ARM         | 35.5x71x33     | 1980    | 2195                  | 2410   | 2625   | 2840                             | 3055                      | 1790   | 1885     | 1980      |
| 017 DOUBLE CHAIR                  | 49.5x39.5x33   | 1640    | 1745                  | 1850   | 1955   | 2060                             | 2165                      | 1310   | 1360     | 1410      |
| 051 ARMLESS CHAIR                 | 27x35.5x33     | 820     | 925                   | 1030   | 1135   | 1240                             | 1345                      | 790    | 840      | 890       |
| 055 SQUARE CORNER                 | 35.5x35.5x33   | 1170    | 1275                  | 1380   | 1485   | 1590                             | 1695                      | 1010   | 1060     | 1110      |
| 056 CHAIR RIGHT ARM               | 35.5x35.5x33   | 1170    | 1275                  | 1380   | 1485   | 1590                             | 1695                      | 1010   | 1060     | 1110      |
| 057 CHAIR LEFT ARM                | 35.5x35.5x33   | 1170    | 1275                  | 1380   | 1485   | 1590                             | 1695                      | 1010   | 1060     | 1110      |
| 115 LARGE OTTOMAN                 | 30 x 39.5x16.5 | 785     | 890                   | 995  | 1100   | 1205                             | 1310                      | 775    | 825      | 875       |
| 173 DOUBLE LOUNGE CHAIR LEFT ARM  | 39.5x79x33     | 2215    | 2430                  | 2645   | 2860   | 3075                             | 3290                      | 1920   | 2015     | 2110      |
| 174 DOUBLE LOUNGE CHAIR RIGHT ARM | 39.5x79x33     | 2215    | 2430                  | 2645   | 2860   | 3075                             | 3290                      | 1920   | 2015     | 2110      |
| 175 DOUBLE CHAIR LEFT ARM         | 39.5x39.5x33   | 1290    | 1395                  | 1500   | 1605   | 1710                             | 1815                      | 1085   | 1135     | 1185      |
| 176 DOUBLE CHAIR RIGHT ARM        | 39.5x39.5x33   | 1290    | 1395                  | 1500   | 1605   | 1710                             | 1815                      | 1085   | 1135     | 1185      |
| 177 ARMLESS DOUBLE CHAIR          | 30x39.5x33     | 935     | 1040                  | 1145   | 1250   | 1355                             | 1460                      | 845    | 895      | 945       |
| 225 SQUARE OTTOMAN                | 35.5x35.5x16.5 | 810     | 915                   | 1020   | 1125   | 1230                             | 1335                      | 775    | 825      | 875       |
| 256 LARGE SQUARE OTTOMAN          | 39.5x39.5x16.5 | 925     | 1030                  | 1135   | 1240   | 1345                             | 1450                      | 835    | 885      | 935       |
| 259 LARGE SQUARE CORNER           | 39.5x39.5x33   | 1290    | 1395                  | 1500   | 1605   | 1710                             | 1815                      | 1085   | 1135     | 1185      |
| 609 ITEMS WITH 27" SEAT WIDTH     |                |         |                       |  |  |                                  |                           |        |          |           |
| <b>CONFIGURATIONS</b>             |                |         |                       |  |  |                                  |                           |        |          |           |

## CDN Price List

### NATURE

| Description                            | L x D x H   | Leather |                       |  |  |                                  |                           | Fabric |          |           |
|--|-------------|---------|-----------------------|--|--|----------------------------------|---------------------------|--------|----------|-----------|
|  |             | 10      | 20<br>Madras<br>Softy | 30<br>Hugo<br>Fantasy<br>Illusion<br>Tucson<br>Utah<br>Vintage<br>Wild Laredo<br>Yukon | 40<br>Elegance<br>Princess<br>Santiago<br>Sensation<br>Sunset<br>Trina<br>Victoria | 50<br>Bull<br>Cassiope<br>Dublin | 60<br>Caress<br>Ultrasued | A      | B<br>COM | C<br>alta |
| A CONFIG 27" (057-056)                 | 71X35.5X33  | 2340    | 2550                  | 2760   | 2970   | 3180                             | 3390                      | 2020   | 2120     | 2220      |
| B CONFIG 27" (057-056-006)             | 71X62.5X33  | 3045    | 3360                  | 3675   | 3990   | 4305                             | 4620                      | 2735   | 2885     | 3035      |
| C CONFIG 27" (057-051-056)             | 98X35.5X33  | 3160    | 3475                  | 3790   | 4105   | 4420                             | 4735                      | 2810   | 2960     | 3110      |
| D CONFIG 27" (057-051-055-051-056-225) | 98X98X33    | 5960    | 6590                  | 7220   | 7850   | 8480                             | 9110                      | 5385   | 5685     | 5985      |
| E CONFIG 30" (175-176)                 | 79X39.5X33  | 2580    | 2790                  | 3000   | 3210   | 3420                             | 3630                      | 2170   | 2270     | 2370      |
| F CONFIG 30" (175-176-115)             | 79X69.5X33  | 3365    | 3680                  | 3995   | 4310   | 4625                             | 4940                      | 2945   | 3095     | 3245      |
| G CONFIG 30" (175-177-176)             | 109X39.5X33 | 3515    | 3830                  | 4145   | 4460   | 4775                             | 5090                      | 3015   | 3165     | 3315      |
| H CONFIG 30" (175-177-259-177-176-256) | 109X109X33  | 6665    | 7295                  | 7925   | 8555   | 9185                             | 9815                      | 5780   | 6080     | 6380      |

# NATURE: RÜBIX COLLECTION

ITEMS 27" & 30" NE SONT PAS COMPATIBLES | ARE NOT COMPATIBLE  
 (PROFONDEUR DES ITEMS DIFFÉRENT | DEPTH OF ITEMS DIFFER)  
 Coussins cylindriques disponibles en ton sur ton ou en combo  
 Roll Cushions available in tone on tone or in combo

## 27" SIÈGES/SEAT

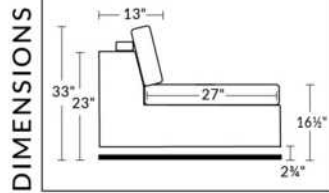

## 30" SIÈGES/SEAT

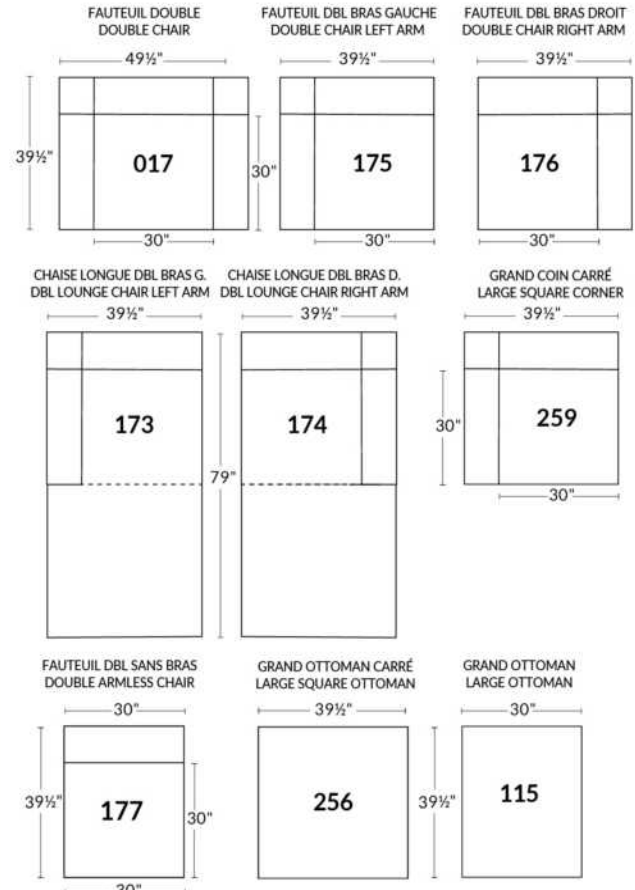
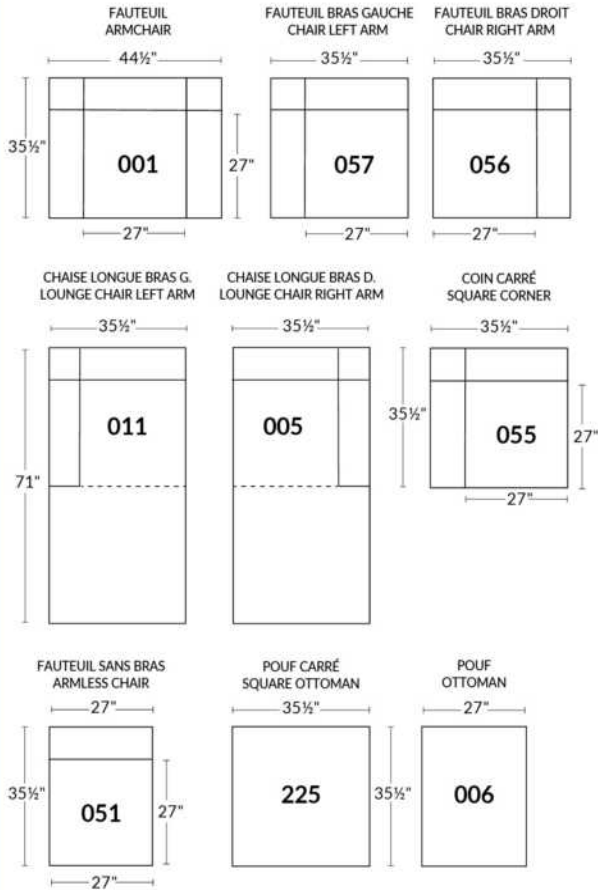
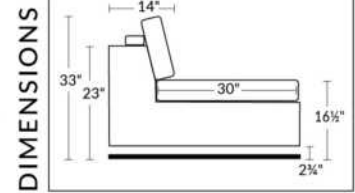

## EXEMPLE CONFIGURATIONS EXAMPLE

ITEMS 27" & 30" NE SONT PAS COMPATIBLES - ARE NOT COMPATIBLE

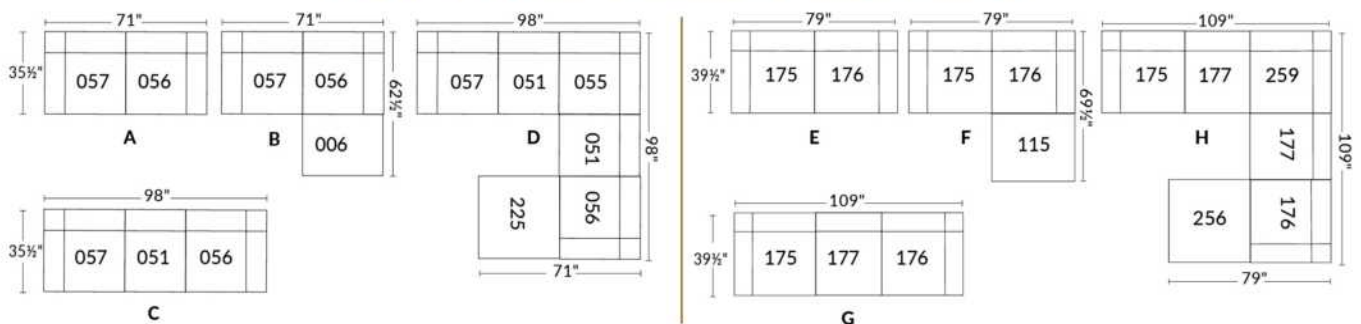

Nos produits sont fabriqués à la main et des variations mineures peuvent survenir.  
 Our product is hand-made and minor variations can occur.

## NICE

### FEATURES:

- Manual adjustable headrest on all items (2 on square corner & stationary on wedge).
- \*Wall hugger power recliners with full footrest (manual n/a).
- Power recliner lounge chair (manual n/a) with power headrest in option. Wall clearance 8" & front 5".
- Seat cushions with shaped foam + 1" layer of memory foam on top; arm with memory foam.
- Stitching: Small thread in fabric & large flat thread in leather.

\*Excludes 043 & 163 chairs: Wall clearance 16"

Note: 2 recliner seats separated by a corner can not be opened at the same time. No recliner seats beside item #155.

### OPTIONS

- Battery Pack: Add \$160/ea.
- \*Motorized headrest: Add \$160 ea. (\*N/A on stationary items).
- Foam: Extra firm add \$15/seat.
- Choice of Large or Small 6" Arm: Leg on LARGE arm: LG103 wood or LG189 metal (Black or Chrome). SMALL 6" Arm: LG08 wood or LG196 metal (Black or Chrome). Specify colour.
- Seat Depth: 20" or \*22". \*22" seat depth N/A on chairs 043 & 163.
- 043 & 163 Chairs: with wood base (specify colour).

| Description                        | L x D x H     | Leather |                       |  |  |                                  |                           | Fabric |          |           |
|------------------------------------|---------------|---------|-----------------------|--|--|----------------------------------|---------------------------|--------|----------|-----------|
|                                    |               | 10      | 20<br>Madras<br>Softy | 30<br>Hugo<br>Fantasy<br>Illusion<br>Tucson<br>Utah<br>Vintage<br>Wild Laredo<br>Yukon | 40<br>Elegance<br>Princess<br>Santiago<br>Sensation<br>Sunset<br>Trina<br>Victoria | 50<br>Bull<br>Cassiope<br>Dublin | 60<br>Caress<br>Ultrasued | A      | B<br>COM | C<br>alta |
| 001 CHAIR                          | 44x40x33/40   | 1890    | 1980                  | 2070   | 2160   | 2250                             | 2340                      | 1535   | 1580     | 1625      |
| 002 LOVESEAT                       | 67x40x33/40   | 2700    | 2815                  | 2930   | 3045   | 3160                             | 3275                      | 2175   | 2250     | 2325      |
| 003 SOFA                           | 91x40x33/40   | 3265    | 3415                  | 3565   | 3715   | 3865                             | 4015                      | 2625   | 2715     | 2805      |
| 005 LOUNGE CHAIR RIGHT ARM         | 34x62x33/40   | 1765    | 1830                  | 1895   | 1960   | 2025                             | 2090                      | 1410   | 1470     | 1530      |
| 009 ARMLESS LOVESEAT               | 47x40x33/40   | 1895    | 1965                  | 2035   | 2105   | 2175                             | 2245                      | 1490   | 1570     | 1650      |
| 011 LOUNGE CHAIR LEFT ARM          | 34x62x33/40   | 1765    | 1830                  | 1895   | 1960   | 2025                             | 2090                      | 1410   | 1470     | 1530      |
| 012 LOVESEAT LEFT ARM              | 57x40x33/40   | 2320    | 2420                  | 2520   | 2620   | 2720                             | 2820                      | 1850   | 1925     | 2000      |
| 017 DOUBLE CHAIR                   | 51x40x33/40   | 1980    | 2080                  | 2180   | 2280   | 2380                             | 2480                      | 1600   | 1660     | 1720      |
| 021 APARTMENT SOFA NO ARM          | 61x40x33/40   | 2140    | 2240                  | 2340   | 2440   | 2540                             | 2640                      | 1670   | 1755     | 1840      |
| 040 ARMLESS SOFA                   | 71x40x33/40   | 2450    | 2565                  | 2680   | 2795   | 2910                             | 3025                      | 1950   | 2040     | 2130      |
| 041 RECLINING CHAIR LEFT ARM       | 34x40x33/40   | 1885    | 1960                  | 2035   | 2110   | 2185                             | 2260                      | 1605   | 1640     | 1675      |
| 042 RECLINING CHAIR RIGHT ARM      | 34x40x33/40   | 1885    | 1960                  | 2035   | 2110   | 2185                             | 2260                      | 1605   | 1640     | 1675      |
| 043 SWIVEL ROCKING RECLINING CHAIR | 30x34x42      | 2235    | 2345                  | 2455   | 2565   | 2675                             | 2785                      | 1875   | 1920     | 1965      |
| 044 RECLINER CHAIR                 | 44x40x33/40   | 2275    | 2365                  | 2455   | 2545   | 2635                             | 2725                      | 1920   | 1970     | 2020      |
| 045 ARMLESS LOVESEAT BUMPER RIGHT  | 68x40x33/40   | 2245    | 2340                  | 2435   | 2530   | 2625                             | 2720                      | 1785   | 1850     | 1915      |
| 050 WEDGE                          | 49x49x33      | 1645    | 1745                  | 1845   | 1945   | 2045                             | 2145                      | 1210   | 1270     | 1330      |
| 051 ARMLESS CHAIR                  | 23,5x40x33/40 | 1085    | 1135                  | 1185   | 1235   | 1285                             | 1335                      | 845    | 900      | 955       |
| 052 SOFA LEFT ARM                  | 81x40x33/40   | 2870    | 3005                  | 3140   | 3275   | 3410                             | 3545                      | 2290   | 2385     | 2480      |
| 053 SOFA RIGHT ARM                 | 81x40x33/40   | 2870    | 3005                  | 3140   | 3275   | 3410                             | 3545                      | 2290   | 2385     | 2480      |

## NICE

### FEATURES:

- Manual adjustable headrest on all items (2 on square corner & stationary on wedge).
- \*Wall hugger power recliners with full footrest (manual n/a).
- Power recliner lounge chair (manual n/a) with power headrest in option. Wall clearance 8" & front 5".
- Seat cushions with shaped foam + 1" layer of memory foam on top; arm with memory foam.
- Stitching: Small thread in fabric & large flat thread in leather.
- \*Excludes 043 & 163 chairs: Wall clearance 16"

Note: 2 recliner seats separated by a corner can not be opened at the same time. No recliner seats beside item #155.

### OPTIONS

- Battery Pack: Add \$160/ea.
- \*Motorized headrest: Add \$160 ea. (\*N/A on stationary items).
- Foam: Extra firm add \$15/seat.
- Choice of Large or Small 6" Arm: Leg on LARGE arm: LG103 wood or LG189 metal (Black or Chrome). SMALL 6" Arm: LG08 wood or LG196 metal (Black or Chrome). Specify colour.
- Seat Depth: 20" or \*22". \*22" seat depth N/A on chairs 043 & 163.
- 043 & 163 Chairs: with wood base (specify colour).

| Description                            | L x D x H     | Leather |                       |  |  |                                  |                           | Fabric |          |           |
|--|---------------|---------|-----------------------|--|--|----------------------------------|---------------------------|--------|----------|-----------|
|  |               | 10      | 20<br>Madras<br>Softy | 30<br>Hugo<br>Fantasy<br>Illusion<br>Tucson<br>Utah<br>Vintage<br>Wild Laredo<br>Yukon | 40<br>Elegance<br>Princess<br>Santiago<br>Sensation<br>Sunset<br>Trina<br>Victoria | 50<br>Bull<br>Cassiope<br>Dublin | 60<br>Caress<br>Ultrasued | A      | B<br>COM | C<br>alta |
| 055 SQUARE CORNER                      | 44x44x33/40   | 1915    | 2010                  | 2105   | 2200   | 2295                             | 2390                      | 1510   | 1565     | 1620      |
| 056 CHAIR RIGHT ARM                    | 34x40x33/40   | 1510    | 1575                  | 1640   | 1705   | 1770                             | 1835                      | 1200   | 1260     | 1320      |
| 057 CHAIR LEFT ARM                     | 34x40x33/40   | 1510    | 1575                  | 1640   | 1705   | 1770                             | 1835                      | 1200   | 1260     | 1320      |
| 061 LOVESEAT RIGHT ARM                 | 57x40x33/40   | 2320    | 2420                  | 2520   | 2620   | 2720                             | 2820                      | 1850   | 1925     | 2000      |
| 071 ARMLESS RECLINING CHAIR            | 23,5x40x33/40 | 1470    | 1525                  | 1580   | 1635   | 1690                             | 1745                      | 1250   | 1310     | 1370      |
| 086 ARMLESS LOVESEAT BUMPER LEFT       | 68x40x33/40   | 2245    | 2340                  | 2435   | 2530   | 2625                             | 2720                      | 1785   | 1850     | 1915      |
| 088 ARMLESS CHAIR BUMPER LEFT          | 45x40x33/40   | 1440    | 1535                  | 1630   | 1725   | 1820                             | 1915                      | 1130   | 1165     | 1200      |
| 089 ARMLESS CHAIR BUMPER RIGHT         | 45x40x33/40   | 1440    | 1535                  | 1630   | 1725   | 1820                             | 1915                      | 1130   | 1165     | 1200      |
| 095 APARTMENT SOFA                     | 81x40x33/40   | 2940    | 3085                  | 3230   | 3375   | 3520                             | 3665                      | 2350   | 2445     | 2540      |
| 096 APARTMENT SOFA LEFT ARM            | 71x40x33/40   | 2570    | 2680                  | 2790   | 2900   | 3010                             | 3120                      | 2020   | 2110     | 2200      |
| 097 APARTMENT SOFA RIGHT ARM           | 71x40x33/40   | 2570    | 2680                  | 2790   | 2900   | 3010                             | 3120                      | 2020   | 2110     | 2200      |
| 124 STORAGE OTTOMAN                    | 30x22x17      | 745     | 765                   | 785  | 805  | 825                              | 845                       | 650    | 670      | 690       |
| 155 SMALL SQUARE CORNER                | 40x40x33/40   | 1915    | 2010                  | 2105   | 2200   | 2295                             | 2390                      | 1510   | 1565     | 1620      |
| 163 DBL SWIVEL ROCKING RECLINER CHAIR  | 33x34x42      | 2290    | 2410                  | 2530   | 2650   | 2770                             | 2890                      | 1880   | 1930     | 1980      |
| 165 DOUBLE RECLINING CHAIR             | 51x40x33/40   | 2375    | 2475                  | 2575   | 2675   | 2775                             | 2875                      | 2000   | 2065     | 2130      |
| 167 APARTMENT SOFA NO ARM BUMPER LEFT  | 82x40x33/40   | 2490    | 2620                  | 2750   | 2880   | 3010                             | 3140                      | 1960   | 2045     | 2130      |
| 168 APARTMENT SOFA NO ARM BUMPER RIGHT | 82x40x33/40   | 2490    | 2620                  | 2750   | 2880   | 3010                             | 3140                      | 1960   | 2045     | 2130      |
| 169 DOUBLE RECLINING CHAIR LEFT ARM    | 41x40x33/40   | 1990    | 2070                  | 2150   | 2230   | 2310                             | 2390                      | 1670   | 1750     | 1830      |
| 170 DOUBLE RECLINING CHAIR RIGHT ARM   | 41x40x33/40   | 1990    | 2070                  | 2150   | 2230   | 2310                             | 2390                      | 1670   | 1750     | 1830      |
| 171 ARMLESS DOUBLE RECLINING CHAIR     | 30,5X40X33/40 | 1575    | 1625                  | 1675   | 1725   | 1775                             | 1825                      | 1320   | 1380     | 1440      |

## NICE

### FEATURES:

- Manual adjustable headrest on all items (2 on square corner & stationary on wedge).
- \*Wall hugger power recliners with full footrest (manual n/a).
- Power recliner lounge chair (manual n/a) with power headrest in option. Wall clearance 8" & front 5".
- Seat cushions with shaped foam + 1" layer of memory foam on top; arm with memory foam.
- Stitching: Small thread in fabric & large flat thread in leather.
- \*Excludes 043 & 163 chairs: Wall clearance 16"

Note: 2 recliner seats separated by a corner can not be opened at the same time. No recliner seats beside item #155.

### OPTIONS

- Battery Pack: Add \$160/ea.
- \*Motorized headrest: Add \$160 ea. (\*N/A on stationary items).
- Foam: Extra firm add \$15/seat.
- Choice of Large or Small 6" Arm: Leg on LARGE arm: LG103 wood or LG189 metal (Black or Chrome). SMALL 6" Arm: LG08 wood or LG196 metal (Black or Chrome). Specify colour.
- Seat Depth: 20" or \*22". \*22" seat depth N/A on chairs 043 & 163.
- 043 & 163 Chairs: with wood base (specify colour).

| Description                            | L x D x H     | Leather |                       |  |  |                                  |                           | Fabric |          |           |
|--|---------------|---------|-----------------------|--|--|----------------------------------|---------------------------|--------|----------|-----------|
|  |               | 10      | 20<br>Madras<br>Softy | 30<br>Hugo<br>Fantasy<br>Illusion<br>Tucson<br>Utah<br>Vintage<br>Wild Laredo<br>Yukon | 40<br>Elegance<br>Princess<br>Santiago<br>Sensation<br>Sunset<br>Trina<br>Victoria | 50<br>Bull<br>Cassiope<br>Dublin | 60<br>Caress<br>Ultrasued | A      | B<br>COM | C<br>alta |
| 173 DOUBLE LOUNGE CHAIR LEFT ARM       | 41x62x33/40   | 1915    | 2005                  | 2095   | 2185   | 2275                             | 2365                      | 1535   | 1615     | 1695      |
| 174 DOUBLE LOUNGE CHAIR RIGHT ARM      | 41x62x33/40   | 1915    | 2005                  | 2095   | 2185   | 2275                             | 2365                      | 1535   | 1615     | 1695      |
| 175 DOUBLE CHAIR LEFT ARM              | 41x40x33/40   | 1590    | 1680                  | 1770   | 1860   | 1950                             | 2040                      | 1285   | 1350     | 1415      |
| 176 DOUBLE CHAIR RIGHT ARM             | 41x40x33/40   | 1590    | 1680                  | 1770   | 1860   | 1950                             | 2040                      | 1285   | 1350     | 1415      |
| 177 ARMLESS DOUBLE CHAIR               | 30,5x40x33/40 | 1185    | 1250                  | 1315   | 1380   | 1445                             | 1510                      | 915    | 970      | 1025      |
| 178 ARMLESS DOUBLE CHAIR BUMPER LEFT   | 52x40x33/40   | 1545    | 1625                  | 1705   | 1785   | 1865                             | 1945                      | 1230   | 1290     | 1350      |
| 179 ARMLESS DOUBLE CHAIR BUMPER RIGHT  | 52x40x33/40   | 1545    | 1625                  | 1705   | 1785   | 1865                             | 1945                      | 1230   | 1290     | 1350      |
| 186 ARMLESS LOVESEAT BUMPER STORAGE-L  | 68x40x33/40   | 2420    | 2500                  | 2580   | 2660   | 2740                             | 2820                      | 1950   | 2015     | 2080      |
| 187 ARMLESS LOVESEAT BUMPER STORAGE-R  | 68x40x33/40   | 2420    | 2500                  | 2580   | 2660   | 2740                             | 2820                      | 1950   | 2015     | 2080      |
| 188 ARMLESS CHAIR BUMPER STORAGE-L     | 45x40x33/40   | 1600    | 1690                  | 1780   | 1870   | 1960                             | 2050                      | 1295   | 1330     | 1365      |
| 189 ARMLESS CHAIR BUMPER STORAGE-R     | 45x40x33/40   | 1600    | 1690                  | 1780   | 1870   | 1960                             | 2050                      | 1295   | 1330     | 1365      |
| 221 ARMLESS DBL CHAIR BUMPER STORAGE-L | 52x40x33/40   | 1705    | 1790                  | 1875   | 1960   | 2045                             | 2130                      | 1390   | 1450     | 1510      |
| 222 ARMLESS DBL CHAIR BUMPER STORAGE-R | 52x40x33/40   | 1705    | 1790                  | 1875   | 1960   | 2045                             | 2130                      | 1390   | 1450     | 1510      |
| 223 APT SOFA NO ARM BUMPER STORAGE-L   | 82x40x33/40   | 2655    | 2785                  | 2915   | 3045   | 3175                             | 3305                      | 2120   | 2215     | 2310      |
| 224 APT SOFA NO ARM BUMPER STORAGE-R   | 82x40x33/40   | 2655    | 2785                  | 2915   | 3045   | 3175                             | 3305                      | 2120   | 2215     | 2310      |
| 236 RECLINING LOUNGE CHAIR LEFT ARM    | 34x62x33/40   | 2160    | 2225                  | 2290   | 2355   | 2420                             | 2485                      | 1820   | 1880     | 1940      |
| 237 RECLINING LOUNGE CHAIR RIGHT ARM   | 34x62x33/40   | 2160    | 2225                  | 2290   | 2355   | 2420                             | 2485                      | 1820   | 1880     | 1940      |
| 238 RECLINING DBL LOUNGE CHAIR L-ARM   | 41x62x33/40   | 2315    | 2405                  | 2495   | 2585   | 2675                             | 2765                      | 1940   | 2020     | 2100      |
| 239 RECLINING DBL LOUNGE CHAIR R-ARM   | 41x62x33/40   | 2315    | 2405                  | 2495   | 2585   | 2675                             | 2765                      | 1940   | 2020     | 2100      |
| <b>CONFIGURATIONS</b>                  |               |         |                       |  |  |                                  |                           |        |          |           |

## CDN Price List

### NICE

| Description                | L x D x H  | Leather |                       |  |  |                                  |                           | Fabric |          |           |
|----------------------------|------------|---------|-----------------------|--|--|----------------------------------|---------------------------|--------|----------|-----------|
|                            |            | 10      | 20<br>Madras<br>Softy | 30<br>Hugo<br>Fantasy<br>Illusion<br>Tucson<br>Utah<br>Vintage<br>Wild Laredo<br>Yukon | 40<br>Elegance<br>Princess<br>Santiago<br>Sensation<br>Sunset<br>Trina<br>Victoria | 50<br>Bull<br>Cassiope<br>Dublin | 60<br>Caress<br>Ultrasued | A      | B<br>COM | C<br>alta |
| A CONFIG (169-170)         | 82X40X40   | 3980    | 4140                  | 4300   | 4460   | 4620                             | 4780                      | 3340   | 3500     | 3660      |
| B CONFIG (169-171-174)     | 113X62X40  | 5480    | 5700                  | 5920   | 6140   | 6360                             | 6580                      | 4525   | 4745     | 4965      |
| C CONFIG (096-055-171-170) | 115X115X40 | 8050    | 8385                  | 8720   | 9055   | 9390                             | 9725                      | 6520   | 6805     | 7090      |
| D CONFIG (169-171-055-179) | 115X96X40  | 7025    | 7330                  | 7635   | 7940   | 8245                             | 8550                      | 5730   | 5985     | 6240      |
| J CONFIG (041-042)         | 68X40X40   | 3770    | 3920                  | 4070   | 4220   | 4370                             | 4520                      | 3210   | 3280     | 3350      |
| K CONFIG (041-071-005)     | 92X62X40   | 5120    | 5315                  | 5510   | 5705   | 5900                             | 6095                      | 4265   | 4420     | 4575      |
| L CONFIG (012-055-071-042) | 102X102X40 | 7590    | 7915                  | 8240   | 8565   | 8890                             | 9215                      | 6215   | 6440     | 6665      |
| M CONFIG (041-071-055-089) | 102X89X40  | 6710    | 7030                  | 7350   | 7670   | 7990                             | 8310                      | 5495   | 5680     | 5865      |





# NICE

**OPTIMA**  
Collection

**Jaymar**

Conçu et fabriqué fièrement au Canada  
Proudly designed and made in Canada

Nos produits sont fabriqués à la main et des variations mineures peuvent survenir

Our product is hand-made and minor variations can occur.

## SPECIFICATIONS

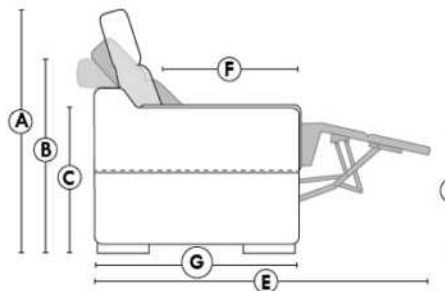

- Appui-tête levé Headrest up
- Appui-tête baissé Headrest down
- Complètement incliné Fully reclined

- A** Hauteur complète 40" Total Height
- B** Hauteur appui-tête baissé 33" Height headrest down
- C** Hauteur du bras 24,5" Arm Height
- D** Hauteur du siège 19,5" Seat height
- E** Profondeur inclinée 65" Depth fully reclined
- F** Profondeur d'assise 20"ou/ou 22" Seat depth
- G** Profondeur appui-tête monté 37,5" Depth with headrest up

## BRAS | ARMS

Option de bras:  
Bras Régulier Large 10" ou Petit bras 6"

Arm option  
Regular arm Large 10" or Small arm 6"

Contrôle de l'inclinaison situé à l'extérieur du bras  
Recliner control located on the outside of the arm.

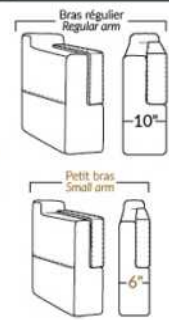

## FAUTEUIL BERÇANT PIVOTANT INCLINABLE SWIVEL ROCKING MOTION CHAIR

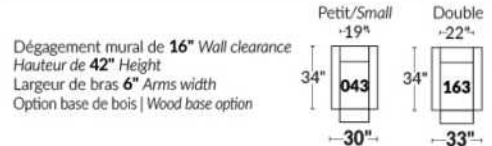

## SIÈGE 23" DE LARGE | 23" SEAT WIDTH

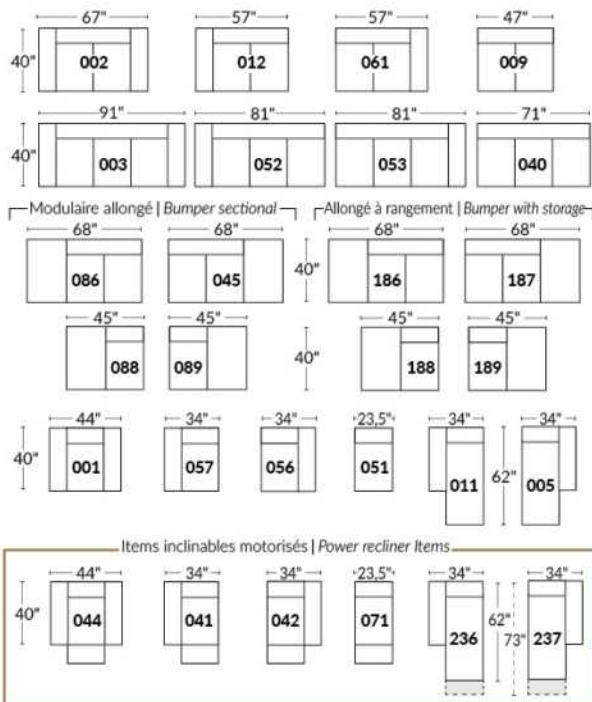

## SIÈGE 30" DE LARGE | 30" SEAT WIDTH

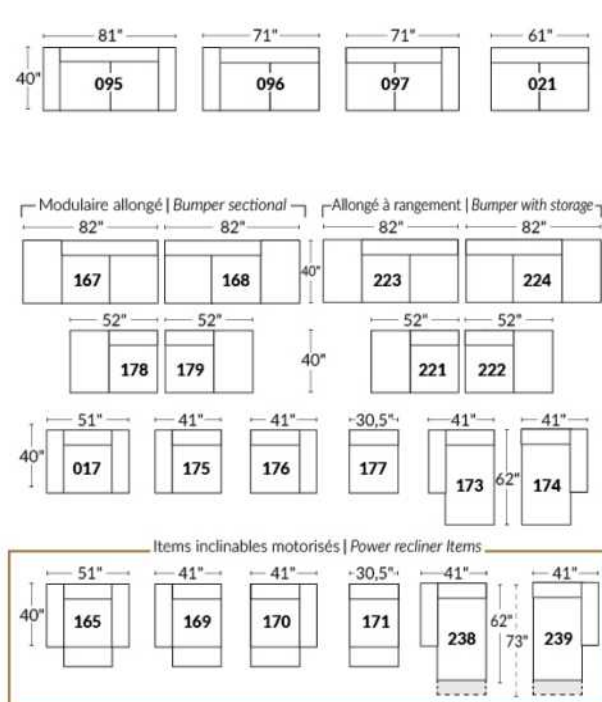

### Autres | Others

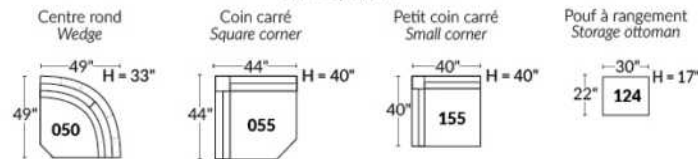

### EXEMPLE 23" EXAMPLE

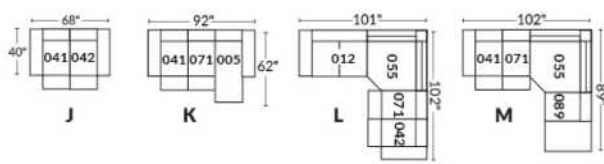

### EXEMPLE 30" EXAMPLE

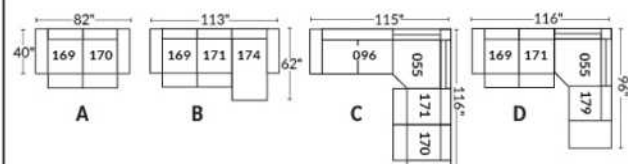

## CDN Price List

### NICOLAS

COMBO: Cover #2 on back and seat only.

Specify colour of base.

| Description        | L x D x H  | Leather |                       |  |  |                                  |                           | Fabric |          |           |
|--------------------|------------|---------|-----------------------|--|--|----------------------------------|---------------------------|--------|----------|-----------|
|                    |            | 10      | 20<br>Madras<br>Softy | 30<br>Hugo<br>Fantasy<br>Illusion<br>Tucson<br>Utah<br>Vintage<br>Wild Laredo<br>Yukon | 40<br>Elegance<br>Princess<br>Santiago<br>Sensation<br>Sunset<br>Trina<br>Victoria | 50<br>Bull<br>Cassiope<br>Dublin | 60<br>Caress<br>Ultrasued | A      | B<br>COM | C<br>alta |
| 001 CHAIR          | 45X37X37   | 1635    | 1720                  | 1805   | 1890   | 1975                             | 2060                      | 1260   | 1320     | 1380      |
| 002 LOVESEAT       | 71X37X37   | 2315    | 2430                  | 2545   | 2660   | 2775                             | 2890                      | 1545   | 1625     | 1705      |
| 006 OTTOMAN        | 31X26X18.5 | 700     | 725                   | 750  | 775  | 800                              | 825                       | 620    | 635      | 650       |
| 095 APARTMENT SOFA | 87X37X37   | 2615    | 2775                  | 2935   | 3095   | 3255                             | 3415                      | 1745   | 1835     | 1925      |

Hauteur de siège 20" | Hauteur devant bras 28" | Profondeur d'assise 20"  
Seat Height 20" | Arm Height 28" | Seat Depth 20"

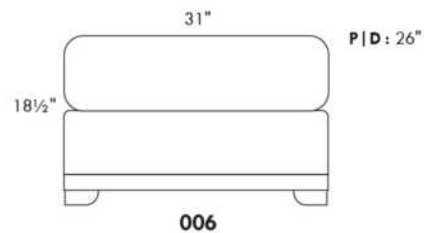
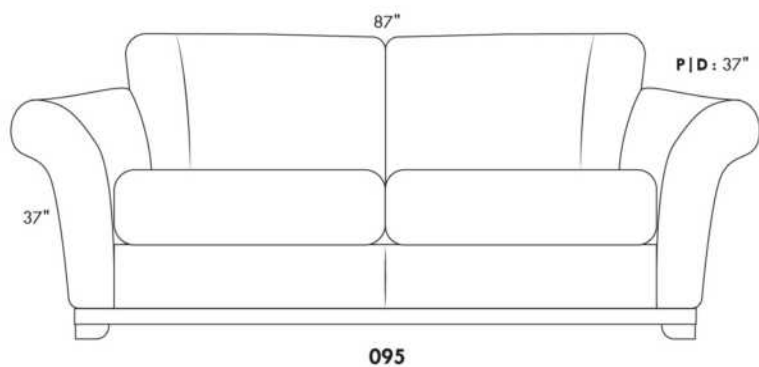
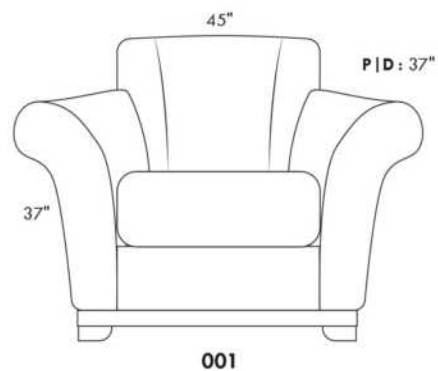
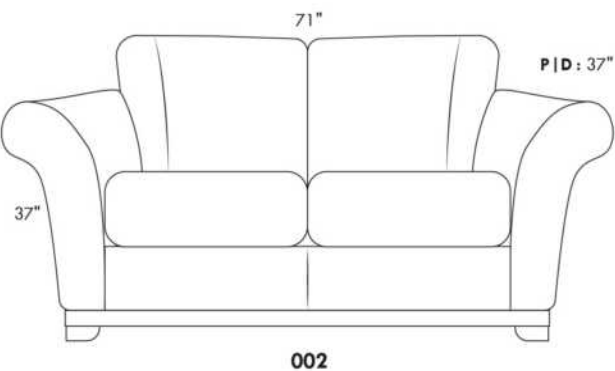

## ODESSA

LEG: LG64 metal or LG35 wood (specify colour). / COMBO: Cover #2 on back only.  
1x Removable head-rest included with motion skus 044, 041, 042 and 071.

Extra head-rest on non motion back; add \$125 per head-rest.

Specify REGULAR SEATING 21" or DEEP SEATING 22". The following items ARE NOT AVAILABLE IN DEEP SEATING: skus 018-023-046-050-055-062-063 & ALL MOTION skus 044-041-042 & 071.

**OPTIONS:**

Upholstery of seat cushions with feathers: Add \$60/seat. \*Bumper counts as 1 seat, skus 005-011-062 & 063 count as 2 seats each.

Sofa bed MATTRESS: Regular 4" thick mattress included. OPTIONAL mattresses:

- 4,5" thick mattress with coils and memory foam with gel: add \$100 or

- 5" thick mattress with high density foam and memory foam with gel: add \$150.

Motorized reclining mechanism with TOUCH-SENSOR button add \$160 per mechanism.

WIRELESS (Battery) motorized reclining mechanism add \$320 per mechanism.

N.B.: 2 reclining seats SEPARATED BY a WEDGE or SQUARE CORNER cannot be opened at the same time.

| Description                       | L x D x H    | Leather |                       |  |  |                                  |                           | Fabric |          |           |
|-----------------------------------|--------------|---------|-----------------------|--|--|----------------------------------|---------------------------|--------|----------|-----------|
|                                   |              | 10      | 20<br>Madras<br>Softy | 30<br>Hugo<br>Fantasy<br>Illusion<br>Tucson<br>Utah<br>Vintage<br>Wild Laredo<br>Yukon | 40<br>Elegance<br>Princess<br>Santiago<br>Sensation<br>Sunset<br>Trina<br>Victoria | 50<br>Bull<br>Cassiope<br>Dublin | 60<br>Caress<br>Ultrasued | A      | B<br>COM | C<br>alta |
| 001 CHAIR                         | 40X37X35     | 1390    | 1485                  | 1580   | 1675   | 1770                             | 1865                      | 995    | 1040     | 1085      |
| 002 LOVESEAT                      | 63X37X35     | 1990    | 2125                  | 2260   | 2395   | 2530                             | 2665                      | 1360   | 1435     | 1510      |
| 003 SOFA                          | 86X37X35     | 2465    | 2635                  | 2805   | 2975   | 3145                             | 3315                      | 1750   | 1845     | 1940      |
| 005 LOUNGE CHAIR RIGHT ARM        | 31.5X61X35   | 1630    | 1740                  | 1850   | 1960   | 2070                             | 2180                      | 1145   | 1225     | 1305      |
| 006 OTTOMAN                       | 25.5X25.5X19 | 630     | 685                   | 740  | 795  | 850                              | 905                       | 535    | 545      | 555       |
| 009 ARMLESS LOVESEAT              | 46X37X35     | 1545    | 1655                  | 1765   | 1875   | 1985                             | 2095                      | 1130   | 1195     | 1260      |
| 011 LOUNGE CHAIR LEFT ARM         | 31.5X61X35   | 1630    | 1740                  | 1850   | 1960   | 2070                             | 2180                      | 1145   | 1225     | 1305      |
| 012 LOVESEAT LEFT ARM             | 54.5X37X35   | 1765    | 1880                  | 1995   | 2110   | 2225                             | 2340                      | 1230   | 1315     | 1400      |
| 018 ANGULAR LOVESEAT LEFT ARM     | 68.5X51X35   | 1875    | 2005                  | 2135   | 2265   | 2395                             | 2525                      | 1335   | 1405     | 1475      |
| 023 ANGULAR LOVESEAT RIGHT ARM    | 68.5X51X35   | 1875    | 2005                  | 2135   | 2265   | 2395                             | 2525                      | 1335   | 1405     | 1475      |
| 040 ARMLESS SOFA                  | 69X37X35     | 2040    | 2185                  | 2330   | 2475   | 2620                             | 2765                      | 1495   | 1600     | 1705      |
| 041 RECLINING CHAIR LEFT ARM      | 31.5X37X35   | 1580    | 1660                  | 1740   | 1820   | 1900                             | 1980                      | 1300   | 1360     | 1420      |
| 042 RECLINING CHAIR RIGHT ARM     | 31.5X37X35   | 1580    | 1660                  | 1740   | 1820   | 1900                             | 1980                      | 1300   | 1360     | 1420      |
| 044 RECLINER CHAIR                | 40X37X35     | 1800    | 1900                  | 2000   | 2100   | 2200                             | 2300                      | 1395   | 1475     | 1555      |
| 045 ARMLESS LOVESEAT BUMPER RIGHT | 66X37X35     | 1795    | 1930                  | 2065   | 2200   | 2335                             | 2470                      | 1255   | 1330     | 1405      |
| 046 ARMLESS ANGULAR LOVESEAT      | 60X51X35     | 1690    | 1805                  | 1920   | 2035   | 2150                             | 2265                      | 1210   | 1295     | 1380      |
| 050 WEDGE                         | 48X48X35     | 1460    | 1545                  | 1630   | 1715   | 1800                             | 1885                      | 1125   | 1170     | 1215      |
| 051 ARMLESS CHAIR                 | 23X37X35     | 945     | 1005                  | 1065   | 1125   | 1185                             | 1245                      | 765    | 815      | 865       |
| 052 SOFA LEFT ARM                 | 77.5X37X35   | 2240    | 2405                  | 2570   | 2735   | 2900                             | 3065                      | 1620   | 1720     | 1820      |
| 053 SOFA RIGHT ARM                | 77.5X37X35   | 2240    | 2405                  | 2570   | 2735   | 2900                             | 3065                      | 1620   | 1720     | 1820      |
| 055 SQUARE CORNER                 | 37X37X35     | 1400    | 1485                  | 1570   | 1655   | 1740                             | 1825                      | 1055   | 1125     | 1195      |
| 056 CHAIR RIGHT ARM               | 31.5X37X35   | 1155    | 1260                  | 1365   | 1470   | 1575                             | 1680                      | 890    | 940      | 990       |

## ODESSA

LEG: LG64 metal or LG35 wood (specify colour). / COMBO: Cover #2 on back only.  
1x Removable head-rest included with motion skus 044, 041, 042 and 071.

Extra head-rest on non motion back; add \$125 per head-rest.

Specify REGULAR SEATING 21" or DEEP SEATING 22". The following items ARE NOT AVAILABLE IN DEEP SEATING: skus 018-023-046-050-055-062-063 & ALL MOTION skus 044-041-042 & 071.

### OPTIONS:

Upholstery of seat cushions with feathers: Add \$60/seat. \*Bumper counts as 1 seat, skus 005-011-062 & 063 count as 2 seats each.

Sofa bed MATTRESS: Regular 4" thick mattress included. OPTIONAL mattresses:

- 4,5" thick mattress with coils and memory foam with gel: add \$100 or

- 5" thick mattress with high density foam and memory foam with gel: add \$150.

Motorized reclining mechanism with TOUCH-SENSOR button add \$160 per mechanism.

WIRELESS (Battery) motorized reclining mechanism add \$320 per mechanism.

N.B.: 2 reclining seats SEPARATED BY a WEDGE or SQUARE CORNER cannot be opened at the same time.

| Description                      | L x D x H  | Leather |                       |  |  |                                  |                            | Fabric |          |           |
|----------------------------------|------------|---------|-----------------------|--|--|----------------------------------|----------------------------|--------|----------|-----------|
|                                  |            | 10      | 20<br>Madras<br>Softy | 30<br>Hugo<br>Fantasy<br>Illusion<br>Tucson<br>Utah<br>Vintage<br>Wild Laredo<br>Yukon | 40<br>Elegance<br>Princess<br>Santiago<br>Sensation<br>Sunset<br>Trina<br>Victoria | 50<br>Bull<br>Cassiope<br>Dublin | 60<br>Caresse<br>Ultrasued | A      | B<br>COM | C<br>alta |
| 057 CHAIR LEFT ARM               | 31.5X37X35 | 1155    | 1260                  | 1365   | 1470   | 1575                             | 1680                       | 890    | 940      | 990       |
| 060 QUEEN SOFA BED               | 86X37X35   | 2855    | 3025                  | 3195   | 3365   | 3535                             | 3705                       | 2130   | 2240     | 2350      |
| 061 LOVESEAT RIGHT ARM           | 54.5X37X35 | 1765    | 1880                  | 1995   | 2110   | 2225                             | 2340                       | 1230   | 1315     | 1400      |
| 062 ANGLE CHAIR LEFT ARM         | 68.5X65X35 | 1690    | 1780                  | 1870   | 1960   | 2050                             | 2140                       | 1180   | 1270     | 1360      |
| 063 ANGLE CHAIR RIGHT ARM        | 68.5X65X35 | 1690    | 1780                  | 1870   | 1960   | 2050                             | 2140                       | 1180   | 1270     | 1360      |
| 071 ARMLESS RECLINING CHAIR      | 23X37X35   | 1345    | 1410                  | 1475   | 1540   | 1605                             | 1670                       | 1175   | 1225     | 1275      |
| 072 SECTIONAL SOFA LEFT ARM      | 91X37X35   | 2650    | 2805                  | 2960   | 3115   | 3270                             | 3425                       | 1870   | 1975     | 2080      |
| 073 SECTIONAL SOFA RIGHT ARM     | 91X37X35   | 2650    | 2805                  | 2960   | 3115   | 3270                             | 3425                       | 1870   | 1975     | 2080      |
| 079 QUEEN SOFA BED NO ARM        | 69X37X35   | 2420    | 2580                  | 2740   | 2900   | 3060                             | 3220                       | 1885   | 1995     | 2105      |
| 080 ANGULAR OTTOMAN              | 36X27X19   | 735     | 760                   | 785  | 810  | 835                              | 860                        | 610    | 620      | 630       |
| 082 QUEEN SOFA BED LEFT ARM      | 77.5X37X35 | 2615    | 2780                  | 2945   | 3110   | 3275                             | 3440                       | 2020   | 2110     | 2200      |
| 083 QUEEN SOFA BED RIGHT ARM     | 77.5X37X35 | 2615    | 2780                  | 2945   | 3110   | 3275                             | 3440                       | 2020   | 2110     | 2200      |
| 086 ARMLESS LOVESEAT BUMPER LEFT | 66X37X35   | 1795    | 1930                  | 2065   | 2200   | 2335                             | 2470                       | 1255   | 1330     | 1405      |
| 088 ARMLESS CHAIR BUMPER LEFT    | 43X37X35   | 1185    | 1285                  | 1385   | 1485   | 1585                             | 1685                       | 905    | 970      | 1035      |
| 089 ARMLESS CHAIR BUMPER RIGHT   | 43X37X35   | 1185    | 1285                  | 1385   | 1485   | 1585                             | 1685                       | 905    | 970      | 1035      |
| 306 OTTOMAN WITH LOUNGE CUSHION  | 24X24X19   | 750     | 805                   | 860  | 915  | 970                              | 1025                       | 620    | 645      | 670       |

# ODESSA

Hauteur complète 35" | Hauteur de siège 19" | Hauteur devant bras 25" | Profondeur d'assise 21"/22"  
 Total Height 35" | Seat Height 19" | Arm Height 25" | Seat Depth 21"/22"

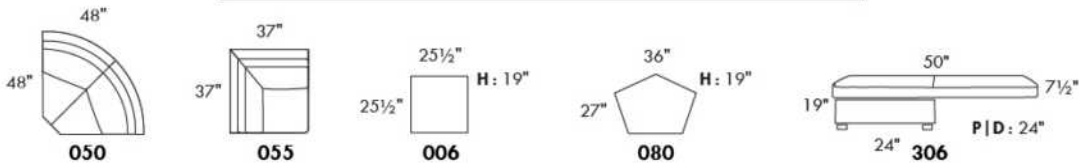
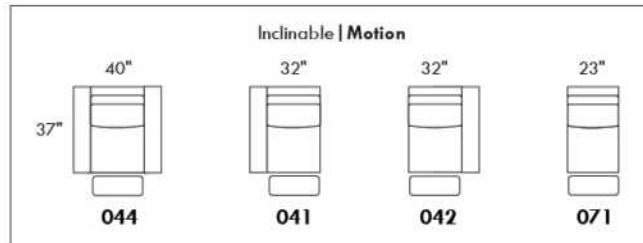
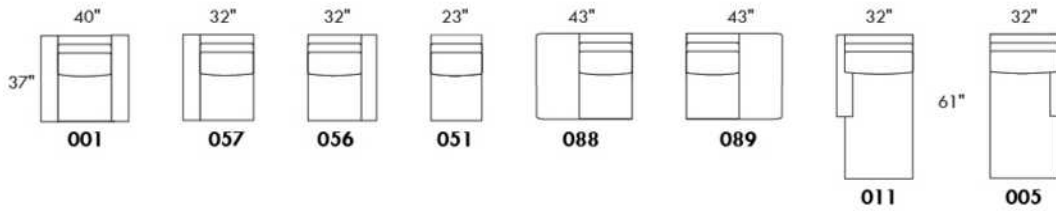
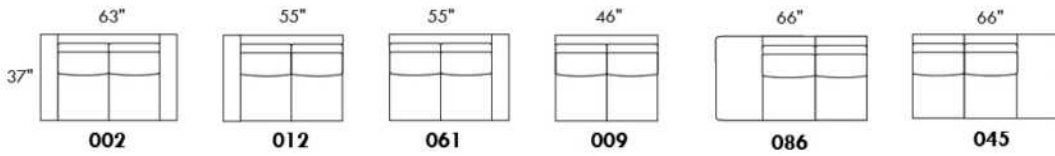
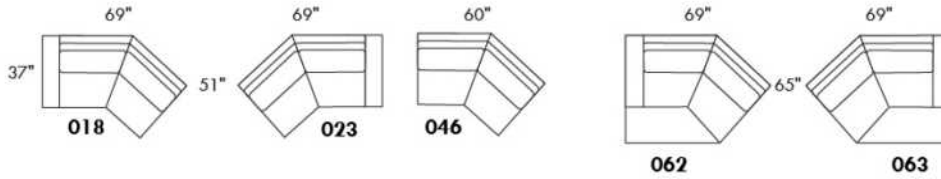
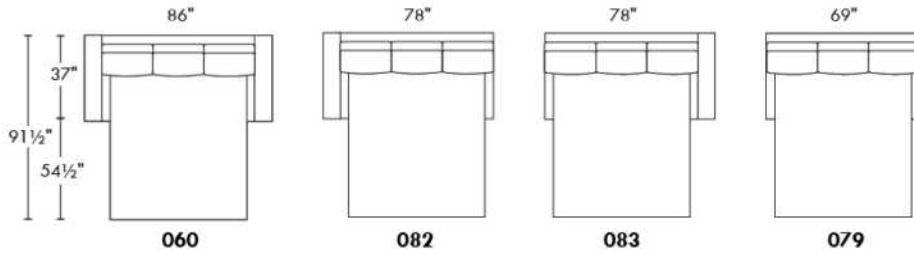
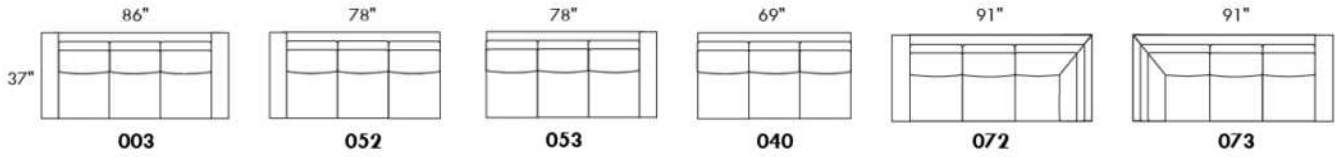

www.jaymar.ca

Toutes les dimensions indiquées sont au pouce près. Nos produits sont fabriqués à la main et des variations mineures peuvent survenir.  
 All dimensions indicated are to the nearest inch. Our product is hand-made and minor variations can occur.

## CDN Price List

### OPTIMA

GENERIC PRICE LIST - FOR DETAILS - SEE MODEL PRICE LIST

**FEATURES:**

- Manual adjustable headrest on all items (2 on square corner & stationary on wedge).
- \*Wall hugger power recliners with full footrest (manual n/a).
- Power recliner lounge chair (manual n/a) with power headrest in option. Wall clearance 8" & front 5".
- Seat cushions with shaped foam + 1" layer of memory foam on top; arm with memory foam.
- Stitching: Small thread in fabric & large flat thread in leather.
- \*Excludes 043 & 163 chairs: Wall clearance 16"

Note: 2 recliner seats separated by a corner can not be opened at the same time. No recliner seats beside #155 Small Square Corner.

**OPTIONS**

- Battery Pack: Add \$160/ea.
- Motorized headrest: Add \$160 ea. (N/A on stationary items).
- Foam: Extra firm add \$15 per seat.
- Seat Depth: 20" or \*22". \*22" seat depth N/A on chairs 043 & 163.
- 043 & 163 Chairs: with wood base (specify colour).

LEG CHOICES : See Model price list.

| Description                        | L x D x H | Leather |                       |  |  |                                  |                           | Fabric |          |           |
|------------------------------------|-----------|---------|-----------------------|--|--|----------------------------------|---------------------------|--------|----------|-----------|
|                                    |           | 10      | 20<br>Madras<br>Softy | 30<br>Hugo<br>Fantasy<br>Illusion<br>Tucson<br>Utah<br>Vintage<br>Wild Laredo<br>Yukon | 40<br>Elegance<br>Princess<br>Santiago<br>Sensation<br>Sunset<br>Trina<br>Victoria | 50<br>Bull<br>Cassiope<br>Dublin | 60<br>Caress<br>Ultrasued | A      | B<br>COM | C<br>alta |
| 001 CHAIR                          |           | 1890    | 1980                  | 2070   | 2160   | 2250                             | 2340                      | 1535   | 1580     | 1625      |
| 002 LOVESEAT                       |           | 2700    | 2815                  | 2930   | 3045   | 3160                             | 3275                      | 2175   | 2250     | 2325      |
| 003 SOFA                           |           | 3265    | 3415                  | 3565   | 3715   | 3865                             | 4015                      | 2625   | 2715     | 2805      |
| 005 LOUNGE CHAIR RIGHT ARM         |           | 1765    | 1830                  | 1895   | 1960   | 2025                             | 2090                      | 1410   | 1470     | 1530      |
| 009 ARMLESS LOVESEAT               |           | 1895    | 1965                  | 2035   | 2105   | 2175                             | 2245                      | 1490   | 1570     | 1650      |
| 011 LOUNGE CHAIR LEFT ARM          |           | 1765    | 1830                  | 1895   | 1960   | 2025                             | 2090                      | 1410   | 1470     | 1530      |
| 012 LOVESEAT LEFT ARM              |           | 2320    | 2420                  | 2520   | 2620   | 2720                             | 2820                      | 1850   | 1925     | 2000      |
| 017 DOUBLE CHAIR                   |           | 1980    | 2080                  | 2180   | 2280   | 2380                             | 2480                      | 1600   | 1660     | 1720      |
| 021 APARTMENT SOFA NO ARM          |           | 2140    | 2240                  | 2340   | 2440   | 2540                             | 2640                      | 1670   | 1755     | 1840      |
| 040 ARMLESS SOFA                   |           | 2450    | 2565                  | 2680   | 2795   | 2910                             | 3025                      | 1950   | 2040     | 2130      |
| 041 RECLINING CHAIR LEFT ARM       |           | 1885    | 1960                  | 2035   | 2110   | 2185                             | 2260                      | 1605   | 1640     | 1675      |
| 042 RECLINING CHAIR RIGHT ARM      |           | 1885    | 1960                  | 2035   | 2110   | 2185                             | 2260                      | 1605   | 1640     | 1675      |
| 043 SWIVEL ROCKING RECLINING CHAIR |           | 2235    | 2345                  | 2455   | 2565   | 2675                             | 2785                      | 1875   | 1920     | 1965      |
| 044 RECLINER CHAIR                 |           | 2275    | 2365                  | 2455   | 2545   | 2635                             | 2725                      | 1920   | 1970     | 2020      |
| 045 ARMLESS LOVESEAT BUMPER RIGHT  |           | 2245    | 2340                  | 2435   | 2530   | 2625                             | 2720                      | 1785   | 1850     | 1915      |
| 050 WEDGE                          |           | 1645    | 1745                  | 1845   | 1945   | 2045                             | 2145                      | 1210   | 1270     | 1330      |
| 051 ARMLESS CHAIR                  |           | 1085    | 1135                  | 1185   | 1235   | 1285                             | 1335                      | 845    | 900      | 955       |

## CDN Price List

### OPTIMA

GENERIC PRICE LIST - FOR DETAILS - SEE MODEL PRICE LIST

#### FEATURES:

- Manual adjustable headrest on all items (2 on square corner & stationary on wedge).
- \*Wall hugger power recliners with full footrest (manual n/a).
- Power recliner lounge chair (manual n/a) with power headrest in option. Wall clearance 8" & front 5".
- Seat cushions with shaped foam + 1" layer of memory foam on top; arm with memory foam.
- Stitching: Small thread in fabric & large flat thread in leather.
- \*Excludes 043 & 163 chairs: Wall clearance 16"

Note: 2 recliner seats separated by a corner can not be opened at the same time. No recliner seats beside #155 Small Square Corner.

#### OPTIONS

- Battery Pack: Add \$160/ea.
- Motorized headrest: Add \$160 ea. (N/A on stationary items).
- Foam: Extra firm add \$15 per seat.
- Seat Depth: 20" or \*22". \*22" seat depth N/A on chairs 043 & 163.
- 043 & 163 Chairs: with wood base (specify colour).

LEG CHOICES : See Model price list.

| Description                      | L x D x H | Leather |                       |  |  |                                  |                           | Fabric |          |           |
|----------------------------------|-----------|---------|-----------------------|--|--|----------------------------------|---------------------------|--------|----------|-----------|
|                                  |           | 10      | 20<br>Madras<br>Softy | 30<br>Hugo<br>Fantasy<br>Illusion<br>Tucson<br>Utah<br>Vintage<br>Wild Laredo<br>Yukon | 40<br>Elegance<br>Princess<br>Santiago<br>Sensation<br>Sunset<br>Trina<br>Victoria | 50<br>Bull<br>Cassiope<br>Dublin | 60<br>Caress<br>Ultrasued | A      | B<br>COM | C<br>alta |
| 052 SOFA LEFT ARM                |           | 2870    | 3005                  | 3140   | 3275   | 3410                             | 3545                      | 2290   | 2385     | 2480      |
| 053 SOFA RIGHT ARM               |           | 2870    | 3005                  | 3140   | 3275   | 3410                             | 3545                      | 2290   | 2385     | 2480      |
| 055 SQUARE CORNER                |           | 1915    | 2010                  | 2105   | 2200   | 2295                             | 2390                      | 1510   | 1565     | 1620      |
| 056 CHAIR RIGHT ARM              |           | 1510    | 1575                  | 1640   | 1705   | 1770                             | 1835                      | 1200   | 1260     | 1320      |
| 057 CHAIR LEFT ARM               |           | 1510    | 1575                  | 1640   | 1705   | 1770                             | 1835                      | 1200   | 1260     | 1320      |
| 061 LOVESEAT RIGHT ARM           |           | 2320    | 2420                  | 2520   | 2620   | 2720                             | 2820                      | 1850   | 1925     | 2000      |
| 071 ARMLESS RECLINING CHAIR      |           | 1470    | 1525                  | 1580   | 1635   | 1690                             | 1745                      | 1250   | 1310     | 1370      |
| 086 ARMLESS LOVESEAT BUMPER LEFT |           | 2245    | 2340                  | 2435   | 2530   | 2625                             | 2720                      | 1785   | 1850     | 1915      |
| 088 ARMLESS CHAIR BUMPER LEFT    |           | 1440    | 1535                  | 1630   | 1725   | 1820                             | 1915                      | 1130   | 1165     | 1200      |
| 089 ARMLESS CHAIR BUMPER RIGHT   |           | 1440    | 1535                  | 1630   | 1725   | 1820                             | 1915                      | 1130   | 1165     | 1200      |
| 095 APARTMENT SOFA               |           | 2940    | 3085                  | 3230   | 3375   | 3520                             | 3665                      | 2350   | 2445     | 2540      |
| 096 APARTMENT SOFA LEFT ARM      |           | 2570    | 2680                  | 2790   | 2900   | 3010                             | 3120                      | 2020   | 2110     | 2200      |
| 097 APARTMENT SOFA RIGHT ARM     |           | 2570    | 2680                  | 2790   | 2900   | 3010                             | 3120                      | 2020   | 2110     | 2200      |
| 124 STORAGE OTTOMAN              |           | 745     | 765                   | 785  | 805  | 825                              | 845                       | 650    | 670      | 690       |
| 138 STRAIGHT ARM                 |           | 415     | 450                   | 485  | 520  | 555                              | 590                       | 350    | 365      | 380       |
| 155 SMALL SQUARE CORNER          |           | 1915    | 2010                  | 2105   | 2200   | 2295                             | 2390                      | 1510   | 1565     | 1620      |
| 159 WEDGE STORAGE                |           | 745     | 775                   | 805  | 835  | 865                              | 895                       | 585    | 600      | 615       |
| 160 STRAIGHT STORAGE             |           | 720     | 745                   | 770  | 795  | 820                              | 845                       | 550    | 570      | 590       |



## CDN Price List

### OPTIMA

GENERIC PRICE LIST - FOR DETAILS - SEE MODEL PRICE LIST

**FEATURES:**

- Manual adjustable headrest on all items (2 on square corner & stationary on wedge).
- \*Wall hugger power recliners with full footrest (manual n/a).
- Power recliner lounge chair (manual n/a) with power headrest in option. Wall clearance 8" & front 5".
- Seat cushions with shaped foam + 1" layer of memory foam on top; arm with memory foam.
- Stitching: Small thread in fabric & large flat thread in leather.
- \*Excludes 043 & 163 chairs: Wall clearance 16"

Note: 2 recliner seats separated by a corner can not be opened at the same time. No recliner seats beside #155 Small Square Corner.

**OPTIONS**

- Battery Pack: Add \$160/ea.
- Motorized headrest: Add \$160 ea. (N/A on stationary items).
- Foam: Extra firm add \$15 per seat.
- Seat Depth: 20" or \*22". \*22" seat depth N/A on chairs 043 & 163.
- 043 & 163 Chairs: with wood base (specify colour).

LEG CHOICES : See Model price list.

| Description                            | L x D x H | Leather |                       |  |  |                                  |                           | Fabric |          |           |
|--|-----------|---------|-----------------------|--|--|----------------------------------|---------------------------|--------|----------|-----------|
|  |           | 10      | 20<br>Madras<br>Softy | 30<br>Hugo<br>Fantasy<br>Illusion<br>Tucson<br>Utah<br>Vintage<br>Wild Laredo<br>Yukon | 40<br>Elegance<br>Princess<br>Santiago<br>Sensation<br>Sunset<br>Trina<br>Victoria | 50<br>Bull<br>Cassiope<br>Dublin | 60<br>Caress<br>Ultrasued | A      | B<br>COM | C<br>alta |
| 163 DBL SWIVEL ROCKING RECLINER CHAIR  |           | 2290    | 2410                  | 2530   | 2650   | 2770                             | 2890                      | 1880   | 1930     | 1980      |
| 165 DOUBLE RECLINING CHAIR             |           | 2375    | 2475                  | 2575   | 2675   | 2775                             | 2875                      | 2000   | 2065     | 2130      |
| 167 APARTMENT SOFA NO ARM BUMPER LEFT  |           | 2490    | 2620                  | 2750   | 2880   | 3010                             | 3140                      | 1960   | 2045     | 2130      |
| 168 APARTMENT SOFA NO ARM BUMPER RIGHT |           | 2490    | 2620                  | 2750   | 2880   | 3010                             | 3140                      | 1960   | 2045     | 2130      |
| 169 DOUBLE RECLINING CHAIR LEFT ARM    |           | 1990    | 2070                  | 2150   | 2230   | 2310                             | 2390                      | 1670   | 1750     | 1830      |
| 170 DOUBLE RECLINING CHAIR RIGHT ARM   |           | 1990    | 2070                  | 2150   | 2230   | 2310                             | 2390                      | 1670   | 1750     | 1830      |
| 171 ARMLESS DOUBLE RECLINING CHAIR     |           | 1575    | 1625                  | 1675   | 1725   | 1775                             | 1825                      | 1320   | 1380     | 1440      |
| 173 DOUBLE LOUNGE CHAIR LEFT ARM       |           | 1915    | 2005                  | 2095   | 2185   | 2275                             | 2365                      | 1535   | 1615     | 1695      |
| 174 DOUBLE LOUNGE CHAIR RIGHT ARM      |           | 1915    | 2005                  | 2095   | 2185   | 2275                             | 2365                      | 1535   | 1615     | 1695      |
| 175 DOUBLE CHAIR LEFT ARM              |           | 1590    | 1680                  | 1770   | 1860   | 1950                             | 2040                      | 1285   | 1350     | 1415      |
| 176 DOUBLE CHAIR RIGHT ARM             |           | 1590    | 1680                  | 1770   | 1860   | 1950                             | 2040                      | 1285   | 1350     | 1415      |
| 177 ARMLESS DOUBLE CHAIR               |           | 1185    | 1250                  | 1315   | 1380   | 1445                             | 1510                      | 915    | 970      | 1025      |
| 178 ARMLESS DOUBLE CHAIR BUMPER LEFT   |           | 1545    | 1625                  | 1705   | 1785   | 1865                             | 1945                      | 1230   | 1290     | 1350      |
| 179 ARMLESS DOUBLE CHAIR BUMPER RIGHT  |           | 1545    | 1625                  | 1705   | 1785   | 1865                             | 1945                      | 1230   | 1290     | 1350      |
| 186 ARMLESS LOVESEAT BUMPER STORAGE-L  |           | 2420    | 2500                  | 2580   | 2660   | 2740                             | 2820                      | 1950   | 2015     | 2080      |
| 187 ARMLESS LOVESEAT BUMPER STORAGE-R  |           | 2420    | 2500                  | 2580   | 2660   | 2740                             | 2820                      | 1950   | 2015     | 2080      |
| 188 ARMLESS CHAIR BUMPER STORAGE-L     |           | 1600    | 1690                  | 1780   | 1870   | 1960                             | 2050                      | 1295   | 1330     | 1365      |
| 189 ARMLESS CHAIR BUMPER STORAGE-R     |           | 1600    | 1690                  | 1780   | 1870   | 1960                             | 2050                      | 1295   | 1330     | 1365      |

## CDN Price List

### OPTIMA

GENERIC PRICE LIST - FOR DETAILS - SEE MODEL PRICE LIST

**FEATURES:**

- Manual adjustable headrest on all items (2 on square corner & stationary on wedge).
- \*Wall hugger power recliners with full footrest (manual n/a).
- Power recliner lounge chair (manual n/a) with power headrest in option. Wall clearance 8" & front 5".
- Seat cushions with shaped foam + 1" layer of memory foam on top; arm with memory foam.
- Stitching: Small thread in fabric & large flat thread in leather.
- \*Excludes 043 & 163 chairs: Wall clearance 16"

Note: 2 recliner seats separated by a corner can not be opened at the same time. No recliner seats beside #155 Small Square Corner.

**OPTIONS**

- Battery Pack: Add \$160/ea.
- Motorized headrest: Add \$160 ea. (N/A on stationary items).
- Foam: Extra firm add \$15 per seat.
- Seat Depth: 20" or \*22". \*22" seat depth N/A on chairs 043 & 163.
- 043 & 163 Chairs: with wood base (specify colour).

LEG CHOICES : See Model price list.

| Description                            | L x D x H | Leather |                       |  |  |                                  |                           | Fabric |          |           |
|--|-----------|---------|-----------------------|--|--|----------------------------------|---------------------------|--------|----------|-----------|
|  |           | 10      | 20<br>Madras<br>Softy | 30<br>Hugo<br>Fantasy<br>Illusion<br>Tucson<br>Utah<br>Vintage<br>Wild Laredo<br>Yukon | 40<br>Elegance<br>Princess<br>Santiago<br>Sensation<br>Sunset<br>Trina<br>Victoria | 50<br>Bull<br>Cassiope<br>Dublin | 60<br>Caress<br>Ultrasued | A      | B<br>COM | C<br>alta |
| 190 SMALL WEDGE STORAGE                |           | 720     | 745                   | 770  | 795  | 820                              | 845                       | 550    | 570      | 590       |
| 221 ARMLESS DBL CHAIR BUMPER STORAGE-L |           | 1705    | 1790                  | 1875   | 1960   | 2045                             | 2130                      | 1390   | 1450     | 1510      |
| 222 ARMLESS DBL CHAIR BUMPER STORAGE-R |           | 1705    | 1790                  | 1875   | 1960   | 2045                             | 2130                      | 1390   | 1450     | 1510      |
| 223 APT SOFA NO ARM BUMPER STORAGE-L   |           | 2655    | 2785                  | 2915   | 3045   | 3175                             | 3305                      | 2120   | 2215     | 2310      |
| 224 APT SOFA NO ARM BUMPER STORAGE-R   |           | 2655    | 2785                  | 2915   | 3045   | 3175                             | 3305                      | 2120   | 2215     | 2310      |
| 236 RECLINING LOUNGE CHAIR LEFT ARM    |           | 2160    | 2225                  | 2290   | 2355   | 2420                             | 2485                      | 1820   | 1880     | 1940      |
| 237 RECLINING LOUNGE CHAIR RIGHT ARM   |           | 2160    | 2225                  | 2290   | 2355   | 2420                             | 2485                      | 1820   | 1880     | 1940      |
| 238 RECLINING DBL LOUNGE CHAIR L-ARM   |           | 2315    | 2405                  | 2495   | 2585   | 2675                             | 2765                      | 1940   | 2020     | 2100      |
| 239 RECLINING DBL LOUNGE CHAIR R-ARM   |           | 2315    | 2405                  | 2495   | 2585   | 2675                             | 2765                      | 1940   | 2020     | 2100      |
| <b>CONFIGURATIONS</b>                  |           |         |                       |  |  |                                  |                           |        |          |           |
| A CONFIG (169-170)                     |           | 3980    | 4140                  | 4300   | 4460   | 4620                             | 4780                      | 3340   | 3500     | 3660      |
| B-1 CONFIG (169-171-174)               |           | 5480    | 5700                  | 5920   | 6140   | 6360                             | 6580                      | 4525   | 4745     | 4965      |
| B-2 CONFIG (173-171-170)               |           | 5480    | 5700                  | 5920   | 6140   | 6360                             | 6580                      | 4525   | 4745     | 4965      |
| C-1 CONFIG (096-055-171-170)           |           | 8050    | 8385                  | 8720   | 9055   | 9390                             | 9725                      | 6520   | 6805     | 7090      |
| C-2 CONFIG (169-171-055-097)           |           | 8050    | 8385                  | 8720   | 9055   | 9390                             | 9725                      | 6520   | 6805     | 7090      |
| D-1 CONFIG (169-171-055-179)           |           | 7025    | 7330                  | 7635   | 7940   | 8245                             | 8550                      | 5730   | 5985     | 6240      |
| D-2 CONFIG (178-055-171-170)           |           | 7025    | 7330                  | 7635   | 7940   | 8245                             | 8550                      | 5730   | 5985     | 6240      |
| E-1 CONFIG (173-177-055-179)           |           | 6560    | 6890                  | 7220   | 7550   | 7880                             | 8210                      | 5190   | 5440     | 5690      |

## CDN Price List

### OPTIMA

| Description                    | L x D x H | Leather |                       |  |  |                                  |                           | Fabric |          |           |
|--------------------------------|-----------|---------|-----------------------|--|--|----------------------------------|---------------------------|--------|----------|-----------|
|                                |           | 10      | 20<br>Madras<br>Softy | 30<br>Hugo<br>Fantasy<br>Illusion<br>Tucson<br>Utah<br>Vintage<br>Wild Laredo<br>Yukon | 40<br>Elegance<br>Princess<br>Santiago<br>Sensation<br>Sunset<br>Trina<br>Victoria | 50<br>Bull<br>Cassiope<br>Dublin | 60<br>Caress<br>Ultrasued | A      | B<br>COM | C<br>alta |
| E-2 CONFIG (178-055-177-174)   |           | 6560    | 6890                  | 7220   | 7550   | 7880                             | 8210                      | 5190   | 5440     | 5690      |
| F CONFIG (169-177-155-177-170) |           | 8265    | 8650                  | 9035   | 9420   | 9805                             | 10190                     | 6680   | 7005     | 7330      |
| G CONFIG (169-159-170)         |           | 4725    | 4915                  | 5105   | 5295   | 5485                             | 5675                      | 3925   | 4100     | 4275      |
| H CONFIG (169-159-171-159-170) |           | 7045    | 7315                  | 7585   | 7855   | 8125                             | 8395                      | 5830   | 6080     | 6330      |
| I CONFIG (169-160-171-160-170) |           | 6995    | 7255                  | 7515   | 7775   | 8035                             | 8295                      | 5760   | 6020     | 6280      |
| J CONFIG (041-042)             |           | 3770    | 3920                  | 4070   | 4220   | 4370                             | 4520                      | 3210   | 3280     | 3350      |
| K-1 CONFIG (041-071-005)       |           | 5120    | 5315                  | 5510   | 5705   | 5900                             | 6095                      | 4265   | 4420     | 4575      |
| K-2 CONFIG (011-071-042)       |           | 5120    | 5315                  | 5510   | 5705   | 5900                             | 6095                      | 4265   | 4420     | 4575      |
| L-1 CONFIG (012-055-071-042)   |           | 7590    | 7915                  | 8240   | 8565   | 8890                             | 9215                      | 6215   | 6440     | 6665      |
| L-2 CONFIG (041-071-055-061)   |           | 7590    | 7915                  | 8240   | 8565   | 8890                             | 9215                      | 6215   | 6440     | 6665      |
| M-1 CONFIG (041-071-055-089)   |           | 6710    | 7030                  | 7350   | 7670   | 7990                             | 8310                      | 5495   | 5680     | 5865      |
| M-2 CONFIG (088-055-071-042)   |           | 6710    | 7030                  | 7350   | 7670   | 7990                             | 8310                      | 5495   | 5680     | 5865      |
| N-1 CONFIG (011-051-055-089)   |           | 6205    | 6510                  | 6815   | 7120   | 7425                             | 7730                      | 4895   | 5100     | 5305      |
| N-2 CONFIG (088-055-051-005)   |           | 6205    | 6510                  | 6815   | 7120   | 7425                             | 7730                      | 4895   | 5100     | 5305      |
| O CONFIG (041-051-155-051-042) |           | 7855    | 8200                  | 8545   | 8890   | 9235                             | 9580                      | 6410   | 6645     | 6880      |
| P CONFIG (041-159-042)         |           | 4515    | 4695                  | 4875   | 5055   | 5235                             | 5415                      | 3795   | 3880     | 3965      |
| Q CONFIG (041-159-071-159-042) |           | 6730    | 6995                  | 7260   | 7525   | 7790                             | 8055                      | 5630   | 5790     | 5950      |
| R CONFIG (041-160-071-160-042) |           | 6680    | 6935                  | 7190   | 7445   | 7700                             | 7955                      | 5560   | 5730     | 5900      |

30" Seat Width | Siège 30" de large

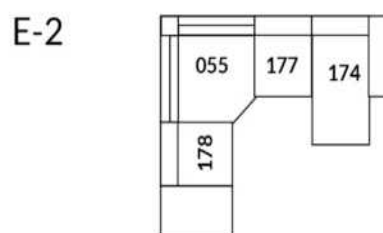
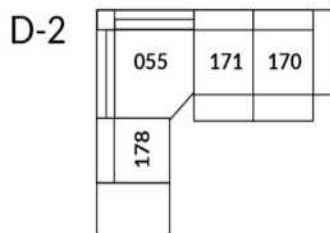
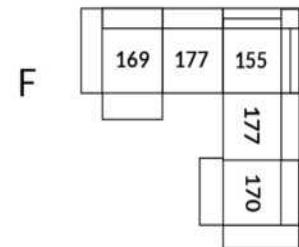
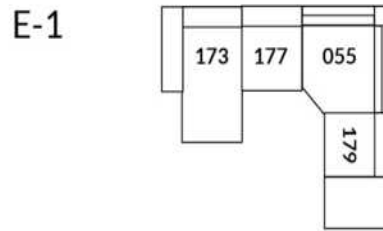
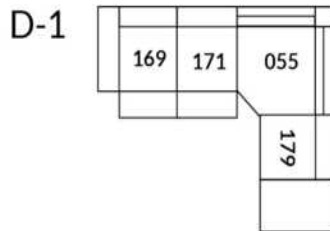
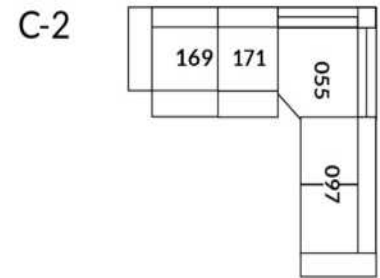
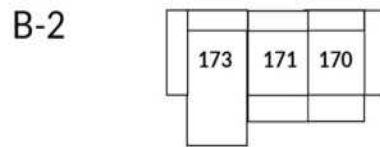
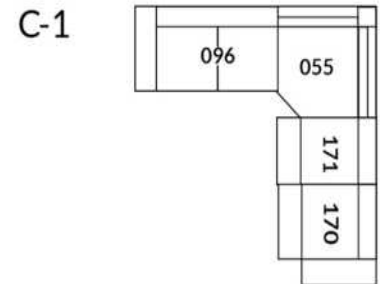
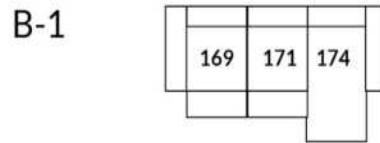
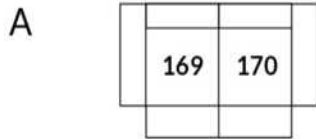

## Home Theatre CONFIGURATIONS Cinéma maison

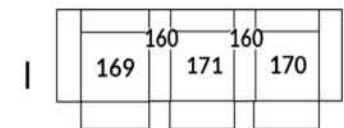
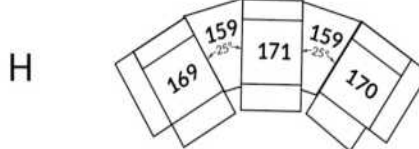
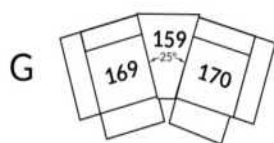

23" Seat Width | Siège 23" de large

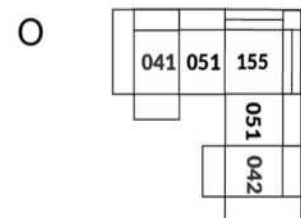
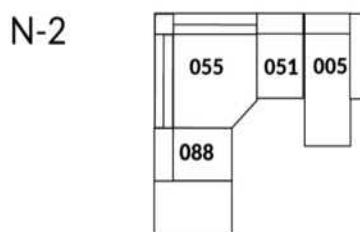
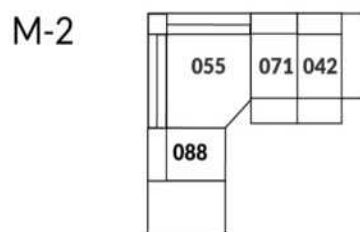
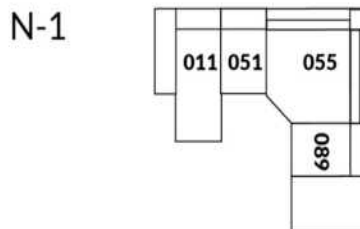
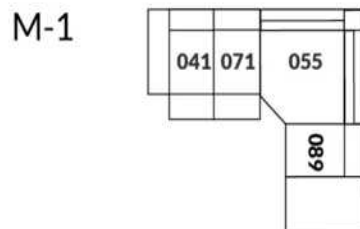
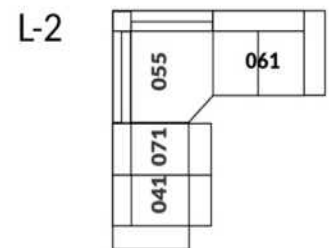
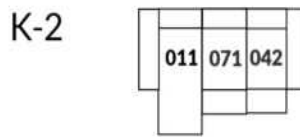
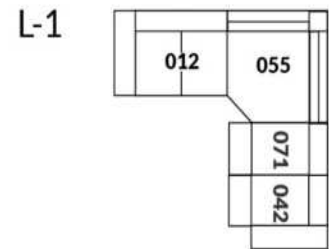
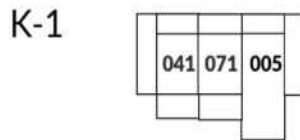
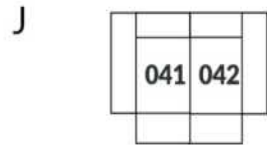

## Home Theatre CONFIGURATIONS Cinéma maison

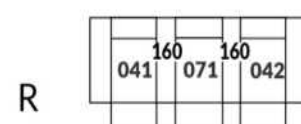
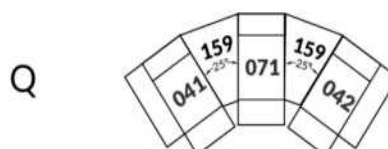
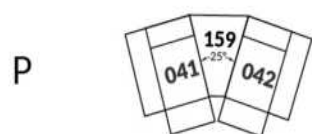

# OPTIMA Collection

**Jaymar**

Conçu et fabriqué fièrement au Canada  
Proudly designed and made in Canada

Nos produits sont fabriqués à la main et  
des variations mineures peuvent survenir

Our product is hand-made and minor variations can occur.

## SPECIFICATIONS

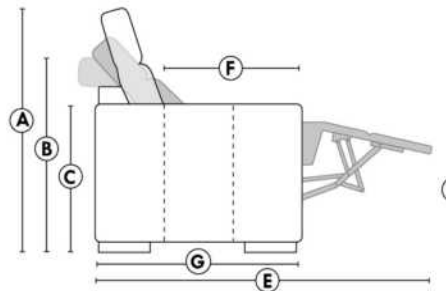

- Appui-tête levé | Headrest up
- Appui-tête baissé | Headrest down
- Complètement incliné | Fully reclined

- A** Hauteur complète 40" Total Height
- B** Hauteur appui-tête baissé 33" Height headrest down
- C** Hauteur du bras 24" Arm Height
- D** Hauteur du siège 19,5" Seat height
- E** Profondeur inclinée 65" Depth fully reclined
- F** Profondeur d'assise 20"/ou/ 22" Seat depth
- G** Profondeur appui-tête monté 37,5" Depth with headrest up

## BRAS | ARMS

Option de bras:  
Bras Régulier Large ou Petit bras

Arm option  
Regular arm Large or Small arm

Option d'accessoires disponible sur  
certain bras régulier seulement

Accessories option, available on certain  
Regular arms ONLY.

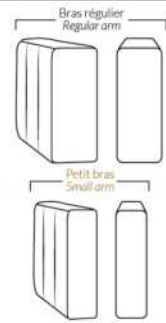

## FAUTEUIL BERÇANT PIVOTANT INCLINABLE SWIVEL ROCKING MOTION CHAIR

Dégagement mural de 16" Wall clearance  
Hauteur de 42" Height  
Largeur de bras 6" Arms width  
Option base de bois | Wood base option

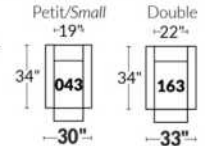

## SIÈGE 23" DE LARGE | 23" SEAT WIDTH

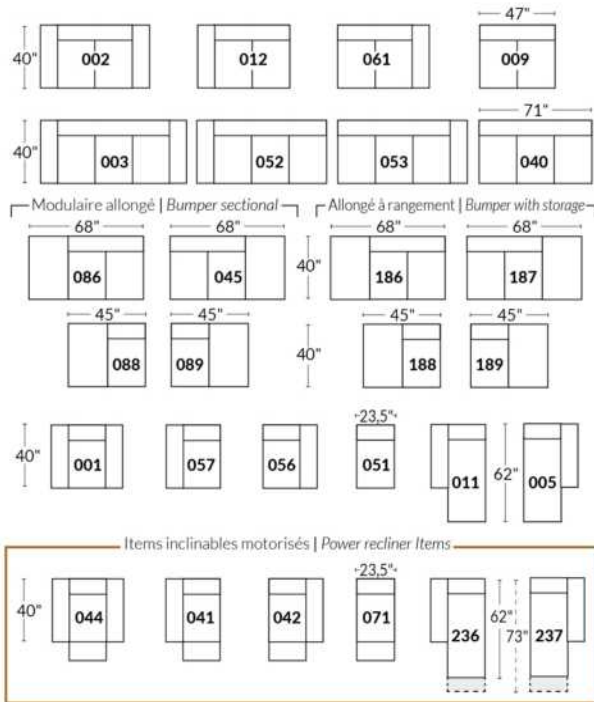

## SIÈGE 30" DE LARGE | 30" SEAT WIDTH

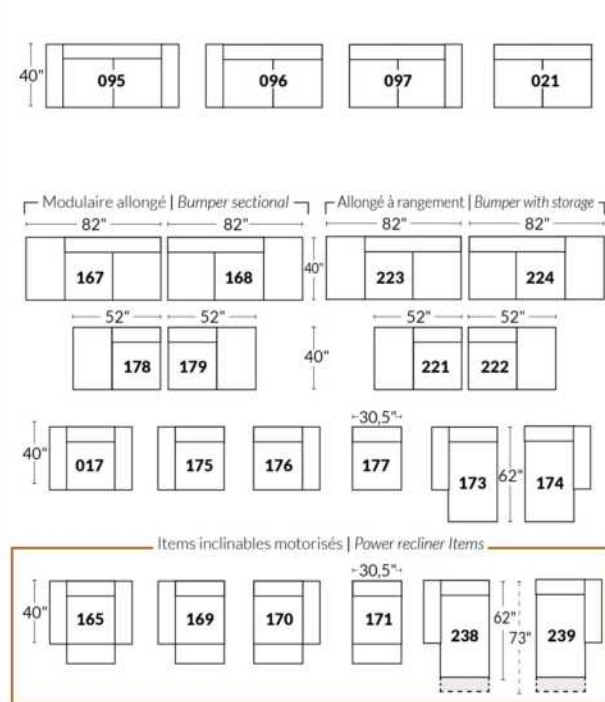

## Autres | Others

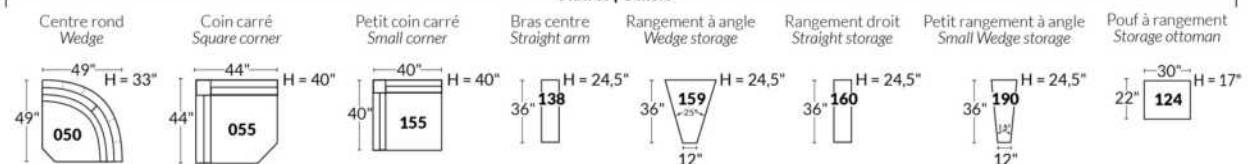

## CDN Price List

### PARIS

FEATURES: Modern style with tufted headrest & base. Decorative metal bar on outside arm. Manual headrest adjustable to 1 position.  
SPECS: Seat Depth: 23". Arm Height: 21". Seat Height: 16,5".

LEG: LG103 wood (specify colour).

ITEMS #194 & #195 Double Angle Chair: Specify colour of wood insert.

| Description                       | L x D x H     | Leather |                       |  |  |                                  |                           | Fabric |          |           |
|-----------------------------------|---------------|---------|-----------------------|--|--|----------------------------------|---------------------------|--------|----------|-----------|
|                                   |               | 10      | 20<br>Madras<br>Softy | 30<br>Hugo<br>Fantasy<br>Illusion<br>Tucson<br>Utah<br>Vintage<br>Wild Laredo<br>Yukon | 40<br>Elegance<br>Princess<br>Santiago<br>Sensation<br>Sunset<br>Trina<br>Victoria | 50<br>Bull<br>Cassiope<br>Dublin | 60<br>Caress<br>Ultrasued | A      | B<br>COM | C<br>alta |
| 006 OTTOMAN                       | 32x24x16      | 765     | 845                   | 925  | 1005   | 1085                             | 1165                      | 650    | 665      | 680       |
| 017 DOUBLE CHAIR                  | 58x40x28/35   | 2165    | 2320                  | 2475   | 2630   | 2785                             | 2940                      | 1730   | 1795     | 1860      |
| 021 APARTMENT SOFA NO ARM         | 64x40x28/35   | 2465    | 2600                  | 2735   | 2870   | 3005                             | 3140                      | 2010   | 2090     | 2170      |
| 050 WEDGE                         | 49x49x21      | 1700    | 1815                  | 1930   | 2045   | 2160                             | 2275                      | 1365   | 1425     | 1485      |
| 095 APARTMENT SOFA                | 89x40x28/35   | 3395    | 3620                  | 3845   | 4070   | 4295                             | 4520                      | 2730   | 2825     | 2920      |
| 096 APARTMENT SOFA LEFT ARM       | 76x40x28/35   | 2940    | 3105                  | 3270   | 3435   | 3600                             | 3765                      | 2375   | 2460     | 2545      |
| 097 APARTMENT SOFA RIGHT ARM      | 76x40x28/35   | 2940    | 3105                  | 3270   | 3435   | 3600                             | 3765                      | 2375   | 2460     | 2545      |
| 173 DOUBLE LOUNGE CHAIR LEFT ARM  | 45x64x28/35   | 2615    | 2795                  | 2975   | 3155   | 3335                             | 3515                      | 2085   | 2170     | 2255      |
| 174 DOUBLE LOUNGE CHAIR RIGHT ARM | 45x64x28/35   | 2615    | 2795                  | 2975   | 3155   | 3335                             | 3515                      | 2085   | 2170     | 2255      |
| 175 DOUBLE CHAIR LEFT ARM         | 45x40x28/35   | 1705    | 1805                  | 1905   | 2005   | 2105                             | 2205                      | 1365   | 1425     | 1485      |
| 176 DOUBLE CHAIR RIGHT ARM        | 45x40x28/35   | 1705    | 1805                  | 1905   | 2005   | 2105                             | 2205                      | 1365   | 1425     | 1485      |
| 177 ARMLESS DOUBLE CHAIR          | 32x40x28/35   | 1240    | 1300                  | 1360   | 1420   | 1480                             | 1540                      | 1005   | 1065     | 1125      |
| 194 DBL ANGLE CHAIR L-ARM         | 74x40x28/35   | 1975    | 2105                  | 2235   | 2365   | 2495                             | 2625                      | 1650   | 1730     | 1810      |
| 195 DBL ANGLE CHAIR R-ARM         | 74x40x28/35   | 1975    | 2105                  | 2235   | 2365   | 2495                             | 2625                      | 1650   | 1730     | 1810      |
| <b>CONFIGURATIONS</b>             |               |         |                       |  |  |                                  |                           |        |          |           |
| A CONFIG (175-177-176)            | 122X40X28/35  | 4650    | 4910                  | 5170   | 5430   | 5690                             | 5950                      | 3735   | 3915     | 4095      |
| B CONFIG (194-097)                | 136X72X28/35  | 4915    | 5210                  | 5505   | 5800   | 6095                             | 6390                      | 4025   | 4190     | 4355      |
| C CONFIG (096-174)                | 121X64X28/35  | 5555    | 5900                  | 6245   | 6590   | 6935                             | 7280                      | 4460   | 4630     | 4800      |
| D CONFIG (173-021-195)            | 169X72X28/35  | 7055    | 7500                  | 7945   | 8390   | 8835                             | 9280                      | 5745   | 5990     | 6235      |
| E CONFIG (096-050-097)            | 125X125X28/35 | 7580    | 8025                  | 8470   | 8915   | 9360                             | 9805                      | 6115   | 6345     | 6575      |

# PARIS



Hauteur complète 28"/35" | Hauteur de siège 16½" | Hauteur devant bras 21" | Profondeur d'assise 23"  
 Total Height 28"/35" | Seat Height 16½" | Arm Height 21" | Seat Depth 23"

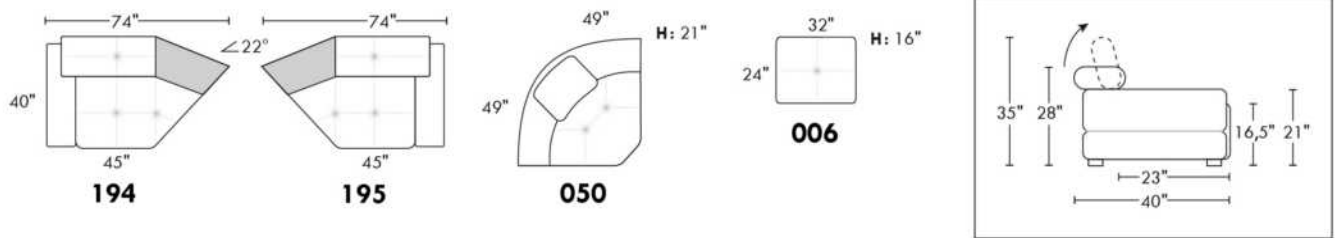
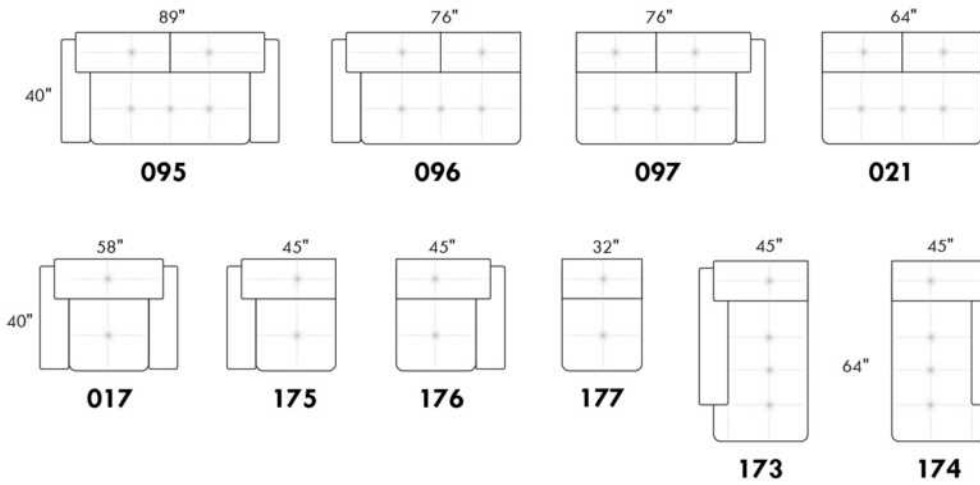

## CONFIGURATIONS

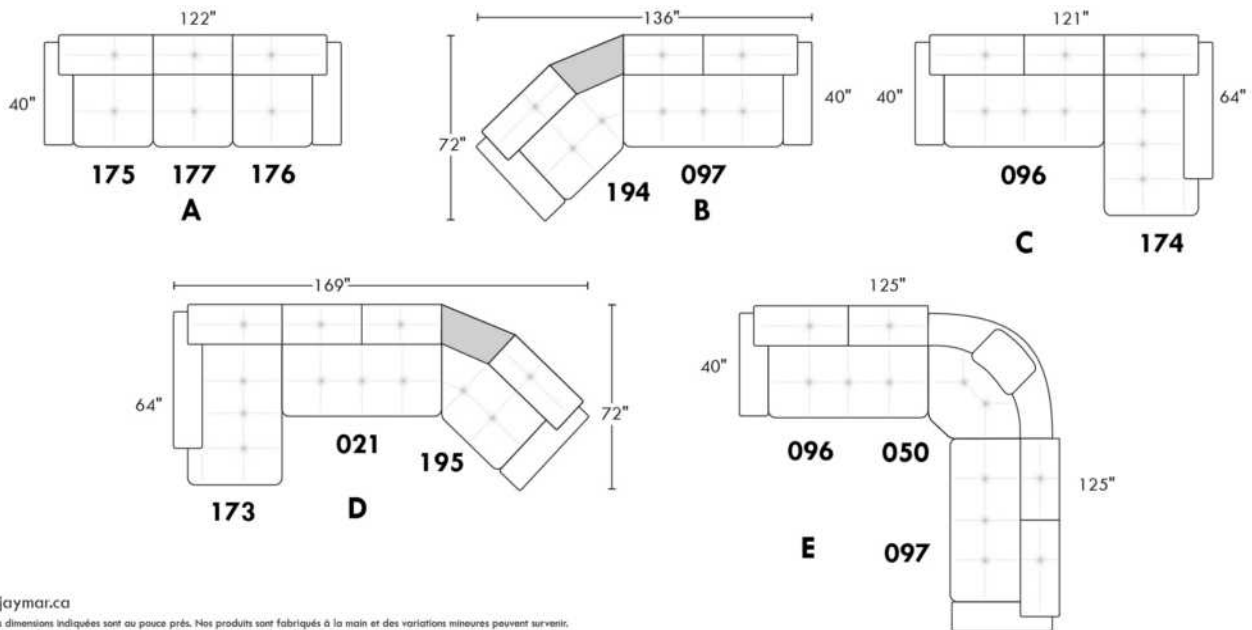

www.jaymar.ca  
 Toutes les dimensions indiquées sont au pouce près. Nos produits sont fabriqués à la main et des variations mineures peuvent survenir.  
 All dimensions indicated are to the nearest inch. Our product is hand-made and minor variations can occur.



## PORTLAND

### FEATURES:

- Manual adjustable headrest on all items (2 on square corner & stationary on wedge).
- \*Wall hugger power recliners with full footrest (manual n/a).
- Power recliner lounge chair (manual n/a) with power headrest in option. Wall clearance 8" & front 5".
- Seat cushions with shaped foam + 1" layer of memory foam on top; arm with memory foam.
- Stitching: Small thread in fabric & large flat thread in leather.
- \*Excludes 043 & 163 chairs: Wall clearance 16"

Note: 2 recliner seats separated by a corner can not be opened at the same time. No recliner seats beside #155 Small Square Corner.

### OPTIONS

- Battery Pack: Add \$160/ea.
- \*Motorized headrest: Add \$160 ea. (\*N/A on stationary items).
- Foam: Extra firm add \$15/seat.
- Choice of Large or Small 6" Arm: Leg on LARGE arm: LG187 wood or LG189 metal (Black or Chrome). Leg on SMALL Arm: LG08 wood or LG64 metal. Specify colour.
- Seat Depth: 20" or \*22". \*22" seat depth N/A on chairs 043 & 163.
- 043 & 163 Chairs: with wood base (specify colour).

| Description                        | L x D x H     | Leather |                       |  |  |                                  |                           | Fabric |          |           |
|------------------------------------|---------------|---------|-----------------------|--|--|----------------------------------|---------------------------|--------|----------|-----------|
|                                    |               | 10      | 20<br>Madras<br>Softy | 30<br>Hugo<br>Fantasy<br>Illusion<br>Tucson<br>Utah<br>Vintage<br>Wild Laredo<br>Yukon | 40<br>Elegance<br>Princess<br>Santiago<br>Sensation<br>Sunset<br>Trina<br>Victoria | 50<br>Bull<br>Cassiope<br>Dublin | 60<br>Caress<br>Ultrasued | A      | B<br>COM | C<br>alta |
| 001 CHAIR                          | 43x40x33/40   | 1890    | 1980                  | 2070   | 2160   | 2250                             | 2340                      | 1535   | 1580     | 1625      |
| 002 LOVESEAT                       | 66x40x33/40   | 2700    | 2815                  | 2930   | 3045   | 3160                             | 3275                      | 2175   | 2250     | 2325      |
| 003 SOFA                           | 90x40x33/40   | 3265    | 3415                  | 3565   | 3715   | 3865                             | 4015                      | 2625   | 2715     | 2805      |
| 005 LOUNGE CHAIR RIGHT ARM         | 34x62x33/40   | 1765    | 1830                  | 1895   | 1960   | 2025                             | 2090                      | 1410   | 1470     | 1530      |
| 009 ARMLESS LOVESEAT               | 47x40x33/40   | 1895    | 1965                  | 2035   | 2105   | 2175                             | 2245                      | 1490   | 1570     | 1650      |
| 011 LOUNGE CHAIR LEFT ARM          | 34x62x33/40   | 1765    | 1830                  | 1895   | 1960   | 2025                             | 2090                      | 1410   | 1470     | 1530      |
| 012 LOVESEAT LEFT ARM              | 57x40x33/40   | 2320    | 2420                  | 2520   | 2620   | 2720                             | 2820                      | 1850   | 1925     | 2000      |
| 017 DOUBLE CHAIR                   | 50x40x33/40   | 1980    | 2080                  | 2180   | 2280   | 2380                             | 2480                      | 1600   | 1660     | 1720      |
| 021 APARTMENT SOFA NO ARM          | 61x40x33/40   | 2140    | 2240                  | 2340   | 2440   | 2540                             | 2640                      | 1670   | 1755     | 1840      |
| 040 ARMLESS SOFA                   | 71x40x33/40   | 2450    | 2565                  | 2680   | 2795   | 2910                             | 3025                      | 1950   | 2040     | 2130      |
| 041 RECLINING CHAIR LEFT ARM       | 34x40x33/40   | 1885    | 1960                  | 2035   | 2110   | 2185                             | 2260                      | 1605   | 1640     | 1675      |
| 042 RECLINING CHAIR RIGHT ARM      | 34x40x33/40   | 1885    | 1960                  | 2035   | 2110   | 2185                             | 2260                      | 1605   | 1640     | 1675      |
| 043 SWIVEL ROCKING RECLINING CHAIR | 30x34x42      | 2235    | 2345                  | 2455   | 2565   | 2675                             | 2785                      | 1875   | 1920     | 1965      |
| 044 RECLINER CHAIR                 | 43x40x33/40   | 2275    | 2365                  | 2455   | 2545   | 2635                             | 2725                      | 1920   | 1970     | 2020      |
| 045 ARMLESS LOVESEAT BUMPER RIGHT  | 68x40x33/40   | 2245    | 2340                  | 2435   | 2530   | 2625                             | 2720                      | 1785   | 1850     | 1915      |
| 050 WEDGE                          | 49x49x33      | 1645    | 1745                  | 1845   | 1945   | 2045                             | 2145                      | 1210   | 1270     | 1330      |
| 051 ARMLESS CHAIR                  | 23,5x40x33/40 | 1085    | 1135                  | 1185   | 1235   | 1285                             | 1335                      | 845    | 900      | 955       |
| 052 SOFA LEFT ARM                  | 81x40x33/40   | 2870    | 3005                  | 3140   | 3275   | 3410                             | 3545                      | 2290   | 2385     | 2480      |
| 053 SOFA RIGHT ARM                 | 81x40x33/40   | 2870    | 3005                  | 3140   | 3275   | 3410                             | 3545                      | 2290   | 2385     | 2480      |

## PORTLAND

**FEATURES:**

- Manual adjustable headrest on all items (2 on square corner & stationary on wedge).
- \*Wall hugger power recliners with full footrest (manual n/a).
- Power recliner lounge chair (manual n/a) with power headrest in option. Wall clearance 8" & front 5".
- Seat cushions with shaped foam + 1" layer of memory foam on top; arm with memory foam.
- Stitching: Small thread in fabric & large flat thread in leather.
- \*Excludes 043 & 163 chairs: Wall clearance 16"

Note: 2 recliner seats separated by a corner can not be opened at the same time. No recliner seats beside #155 Small Square Corner.

**OPTIONS**

- Battery Pack: Add \$160/ea.
- \*Motorized headrest: Add \$160 ea. (\*N/A on stationary items).
- Foam: Extra firm add \$15/seat.
- Choice of Large or Small 6" Arm: Leg on LARGE arm: LG187 wood or LG189 metal (Black or Chrome). Leg on SMALL Arm: LG08 wood or LG64 metal. Specify colour.
- Seat Depth: 20" or \*22". \*22" seat depth N/A on chairs 043 & 163.
- 043 & 163 Chairs: with wood base (specify colour).

| Description                            | L x D x H     | Leather |                       |  |  |                                  |                           | Fabric |          |           |
|--|---------------|---------|-----------------------|--|--|----------------------------------|---------------------------|--------|----------|-----------|
|  |               | 10      | 20<br>Madras<br>Softy | 30<br>Hugo<br>Fantasy<br>Illusion<br>Tucson<br>Utah<br>Vintage<br>Wild Laredo<br>Yukon | 40<br>Elegance<br>Princess<br>Santiago<br>Sensation<br>Sunset<br>Trina<br>Victoria | 50<br>Bull<br>Cassiope<br>Dublin | 60<br>Caress<br>Ultrasued | A      | B<br>COM | C<br>alta |
| 055 SQUARE CORNER                      | 44x44x33/40   | 1915    | 2010                  | 2105   | 2200   | 2295                             | 2390                      | 1510   | 1565     | 1620      |
| 056 CHAIR RIGHT ARM                    | 34x40x33/40   | 1510    | 1575                  | 1640   | 1705   | 1770                             | 1835                      | 1200   | 1260     | 1320      |
| 057 CHAIR LEFT ARM                     | 34x40x33/40   | 1510    | 1575                  | 1640   | 1705   | 1770                             | 1835                      | 1200   | 1260     | 1320      |
| 061 LOVESEAT RIGHT ARM                 | 57x40x33/40   | 2320    | 2420                  | 2520   | 2620   | 2720                             | 2820                      | 1850   | 1925     | 2000      |
| 071 ARMLESS RECLINING CHAIR            | 23,5x40x33/40 | 1470    | 1525                  | 1580   | 1635   | 1690                             | 1745                      | 1250   | 1310     | 1370      |
| 086 ARMLESS LOVESEAT BUMPER LEFT       | 68x40x33/40   | 2245    | 2340                  | 2435   | 2530   | 2625                             | 2720                      | 1785   | 1850     | 1915      |
| 088 ARMLESS CHAIR BUMPER LEFT          | 45x40x33/40   | 1440    | 1535                  | 1630   | 1725   | 1820                             | 1915                      | 1130   | 1165     | 1200      |
| 089 ARMLESS CHAIR BUMPER RIGHT         | 45x40x33/40   | 1440    | 1535                  | 1630   | 1725   | 1820                             | 1915                      | 1130   | 1165     | 1200      |
| 095 APARTMENT SOFA                     | 80x40x33/40   | 2940    | 3085                  | 3230   | 3375   | 3520                             | 3665                      | 2350   | 2445     | 2540      |
| 096 APARTMENT SOFA LEFT ARM            | 71x40x33/40   | 2570    | 2680                  | 2790   | 2900   | 3010                             | 3120                      | 2020   | 2110     | 2200      |
| 097 APARTMENT SOFA RIGHT ARM           | 71x40x33/40   | 2570    | 2680                  | 2790   | 2900   | 3010                             | 3120                      | 2020   | 2110     | 2200      |
| 124 STORAGE OTTOMAN                    | 30x22x17      | 745     | 765                   | 785  | 805  | 825                              | 845                       | 650    | 670      | 690       |
| 155 SMALL SQUARE CORNER                | 40x40x33/40   | 1915    | 2010                  | 2105   | 2200   | 2295                             | 2390                      | 1510   | 1565     | 1620      |
| 163 DBL SWIVEL ROCKING RECLINER CHAIR  | 33x34x42      | 2290    | 2410                  | 2530   | 2650   | 2770                             | 2890                      | 1880   | 1930     | 1980      |
| 165 DOUBLE RECLINING CHAIR             | 50x40x33/40   | 2375    | 2475                  | 2575   | 2675   | 2775                             | 2875                      | 2000   | 2065     | 2130      |
| 167 APARTMENT SOFA NO ARM BUMPER LEFT  | 82x40x33/40   | 2490    | 2620                  | 2750   | 2880   | 3010                             | 3140                      | 1960   | 2045     | 2130      |
| 168 APARTMENT SOFA NO ARM BUMPER RIGHT | 82x40x33/40   | 2490    | 2620                  | 2750   | 2880   | 3010                             | 3140                      | 1960   | 2045     | 2130      |
| 169 DOUBLE RECLINING CHAIR LEFT ARM    | 41x40x33/40   | 1990    | 2070                  | 2150   | 2230   | 2310                             | 2390                      | 1670   | 1750     | 1830      |
| 170 DOUBLE RECLINING CHAIR RIGHT ARM   | 41x40x33/40   | 1990    | 2070                  | 2150   | 2230   | 2310                             | 2390                      | 1670   | 1750     | 1830      |
| 171 ARMLESS DOUBLE RECLINING CHAIR     | 30,5x40x33/40 | 1575    | 1625                  | 1675   | 1725   | 1775                             | 1825                      | 1320   | 1380     | 1440      |

## PORTLAND

### FEATURES:

- Manual adjustable headrest on all items (2 on square corner & stationary on wedge).
- \*Wall hugger power recliners with full footrest (manual n/a).
- Power recliner lounge chair (manual n/a) with power headrest in option. Wall clearance 8" & front 5".
- Seat cushions with shaped foam + 1" layer of memory foam on top; arm with memory foam.
- Stitching: Small thread in fabric & large flat thread in leather.
- \*Excludes 043 & 163 chairs: Wall clearance 16"

Note: 2 recliner seats separated by a corner can not be opened at the same time. No recliner seats beside #155 Small Square Corner.

### OPTIONS

- Battery Pack: Add \$160/ea.
- \*Motorized headrest: Add \$160 ea. (\*N/A on stationary items).
- Foam: Extra firm add \$15/seat.
- Choice of Large or Small 6" Arm: Leg on LARGE arm: LG187 wood or LG189 metal (Black or Chrome). Leg on SMALL Arm: LG08 wood or LG64 metal. Specify colour.
- Seat Depth: 20" or \*22". \*22" seat depth N/A on chairs 043 & 163.
- 043 & 163 Chairs: with wood base (specify colour).

| Description                            | L x D x H     | Leather |                       |  |  |                                  |                           | Fabric |          |           |
|--|---------------|---------|-----------------------|--|--|----------------------------------|---------------------------|--------|----------|-----------|
|  |               | 10      | 20<br>Madras<br>Softy | 30<br>Hugo<br>Fantasy<br>Illusion<br>Tucson<br>Utah<br>Vintage<br>Wild Laredo<br>Yukon | 40<br>Elegance<br>Princess<br>Santiago<br>Sensation<br>Sunset<br>Trina<br>Victoria | 50<br>Bull<br>Cassiope<br>Dublin | 60<br>Caress<br>Ultrasued | A      | B<br>COM | C<br>alta |
| 173 DOUBLE LOUNGE CHAIR LEFT ARM       | 41x62x33/40   | 1915    | 2005                  | 2095   | 2185   | 2275                             | 2365                      | 1535   | 1615     | 1695      |
| 174 DOUBLE LOUNGE CHAIR RIGHT ARM      | 41x62x33/40   | 1915    | 2005                  | 2095   | 2185   | 2275                             | 2365                      | 1535   | 1615     | 1695      |
| 175 DOUBLE CHAIR LEFT ARM              | 41x40x33/40   | 1590    | 1680                  | 1770   | 1860   | 1950                             | 2040                      | 1285   | 1350     | 1415      |
| 176 DOUBLE CHAIR RIGHT ARM             | 41x40x33/40   | 1590    | 1680                  | 1770   | 1860   | 1950                             | 2040                      | 1285   | 1350     | 1415      |
| 177 ARMLESS DOUBLE CHAIR               | 30,5x40x33/40 | 1185    | 1250                  | 1315   | 1380   | 1445                             | 1510                      | 915    | 970      | 1025      |
| 178 ARMLESS DOUBLE CHAIR BUMPER LEFT   | 52x40x33/40   | 1545    | 1625                  | 1705   | 1785   | 1865                             | 1945                      | 1230   | 1290     | 1350      |
| 179 ARMLESS DOUBLE CHAIR BUMPER RIGHT  | 52x40x33/40   | 1545    | 1625                  | 1705   | 1785   | 1865                             | 1945                      | 1230   | 1290     | 1350      |
| 186 ARMLESS LOVESEAT BUMPER STORAGE-L  | 68x40x33/40   | 2420    | 2500                  | 2580   | 2660   | 2740                             | 2820                      | 1950   | 2015     | 2080      |
| 187 ARMLESS LOVESEAT BUMPER STORAGE-R  | 68x40x33/40   | 2420    | 2500                  | 2580   | 2660   | 2740                             | 2820                      | 1950   | 2015     | 2080      |
| 188 ARMLESS CHAIR BUMPER STORAGE-L     | 45x40x33/40   | 1600    | 1690                  | 1780   | 1870   | 1960                             | 2050                      | 1295   | 1330     | 1365      |
| 189 ARMLESS CHAIR BUMPER STORAGE-R     | 45x40x33/40   | 1600    | 1690                  | 1780   | 1870   | 1960                             | 2050                      | 1295   | 1330     | 1365      |
| 221 ARMLESS DBL CHAIR BUMPER STORAGE-L | 52x40x33/40   | 1705    | 1790                  | 1875   | 1960   | 2045                             | 2130                      | 1390   | 1450     | 1510      |
| 222 ARMLESS DBL CHAIR BUMPER STORAGE-R | 52x40x33/40   | 1705    | 1790                  | 1875   | 1960   | 2045                             | 2130                      | 1390   | 1450     | 1510      |
| 223 APT SOFA NO ARM BUMPER STORAGE-L   | 82x40x33/40   | 2655    | 2785                  | 2915   | 3045   | 3175                             | 3305                      | 2120   | 2215     | 2310      |
| 224 APT SOFA NO ARM BUMPER STORAGE-R   | 82x40x33/40   | 2655    | 2785                  | 2915   | 3045   | 3175                             | 3305                      | 2120   | 2215     | 2310      |
| 236 RECLINING LOUNGE CHAIR LEFT ARM    | 34x62x33/40   | 2160    | 2225                  | 2290   | 2355   | 2420                             | 2485                      | 1820   | 1880     | 1940      |
| 237 RECLINING LOUNGE CHAIR RIGHT ARM   | 34x62x33/40   | 2160    | 2225                  | 2290   | 2355   | 2420                             | 2485                      | 1820   | 1880     | 1940      |
| 238 RECLINING DBL LOUNGE CHAIR L-ARM   | 41x62x33/40   | 2315    | 2405                  | 2495   | 2585   | 2675                             | 2765                      | 1940   | 2020     | 2100      |
| 239 RECLINING DBL LOUNGE CHAIR R-ARM   | 41x62x33/40   | 2315    | 2405                  | 2495   | 2585   | 2675                             | 2765                      | 1940   | 2020     | 2100      |
| <b>CONFIGURATIONS</b>                  |               |         |                       |  |  |                                  |                           |        |          |           |

## CDN Price List

### PORTLAND

| Description                | L x D x H  | Leather |                       |  |  |                                  |                           | Fabric |          |           |
|----------------------------|------------|---------|-----------------------|--|--|----------------------------------|---------------------------|--------|----------|-----------|
|                            |            | 10      | 20<br>Madras<br>Softy | 30<br>Hugo<br>Fantasy<br>Illusion<br>Tucson<br>Utah<br>Vintage<br>Wild Laredo<br>Yukon | 40<br>Elegance<br>Princess<br>Santiago<br>Sensation<br>Sunset<br>Trina<br>Victoria | 50<br>Bull<br>Cassiope<br>Dublin | 60<br>Caress<br>Ultrasued | A      | B<br>COM | C<br>alta |
| A CONFIG (169-170)         | 81X40X40   | 3980    | 4140                  | 4300   | 4460   | 4620                             | 4780                      | 3340   | 3500     | 3660      |
| B CONFIG (169-171-174)     | 113X62X40  | 5480    | 5700                  | 5920   | 6140   | 6360                             | 6580                      | 4525   | 4745     | 4965      |
| C CONFIG (096-055-171-170) | 116X116X40 | 8050    | 8385                  | 8720   | 9055   | 9390                             | 9725                      | 6520   | 6805     | 7090      |
| D CONFIG (169-171-055-179) | 116X96X40  | 7025    | 7330                  | 7635   | 7940   | 8245                             | 8550                      | 5730   | 5985     | 6240      |
| J CONFIG (041-042)         | 67X40X40   | 3770    | 3920                  | 4070   | 4220   | 4370                             | 4520                      | 3210   | 3280     | 3350      |
| K CONFIG (041-071-005)     | 92X62X40   | 5120    | 5315                  | 5510   | 5705   | 5900                             | 6095                      | 4265   | 4420     | 4575      |
| L CONFIG (012-055-071-042) | 102X102X40 | 7590    | 7915                  | 8240   | 8565   | 8890                             | 9215                      | 6215   | 6440     | 6665      |
| M CONFIG (041-071-055-089) | 102X89X40  | 6710    | 7030                  | 7350   | 7670   | 7990                             | 8310                      | 5495   | 5680     | 5865      |



# PORTLAND

**OPTIMA**  
Collection

**Jaymar**

Conçu et fabriqué fièrement au Canada  
Proudly designed and made in Canada

Nos produits sont fabriqués à la main et des variations mineures peuvent survenir

Our product is hand-made and minor variations can occur.

## SPECIFICATIONS

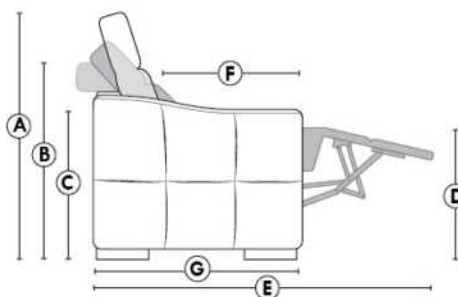

- Appui-tête levé / Headrest up
- Appui-tête baissé / Headrest down
- Complètement incliné / Fully reclined

- A** Hauteur complète 40" Total Height
- B** Hauteur appui-tête baissé 33" Height headrest down
- C** Hauteur du bras 24" Arm Height
- D** Hauteur du siège 19,5" Seat height
- E** Profondeur inclinée 65" Depth fully reclined
- F** Profondeur d'assise 20" ou/ou 22" Seat depth
- G** Profondeur appui-tête monté 37,5" Depth with headrest up

## BRAS | ARMS

Option de bras:  
Bras Régulier Large 9,5" ou Petit bras 6"

Arm option  
Regular arm Large 9.5" or Small arm 6"

Contrôle de l'inclinaison situé à l'extérieur du bras  
Recliner control located on the outside of the arm.

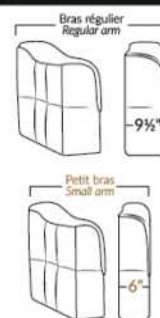

## FAUTEUIL BERÇANT PIVOTANT INCLINABLE SWIVEL ROCKING MOTION CHAIR

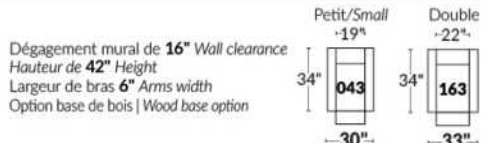

## SIÈGE 23" DE LARGE | 23" SEAT WIDTH

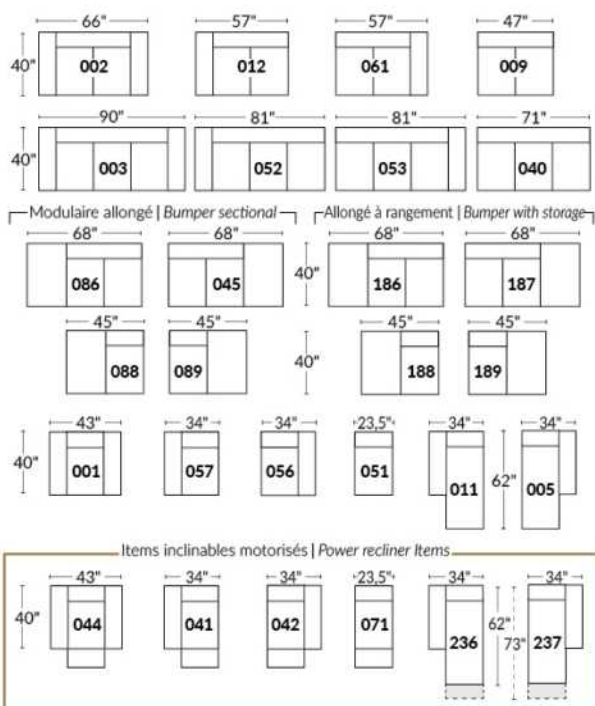

## SIÈGE 30" DE LARGE | 30" SEAT WIDTH

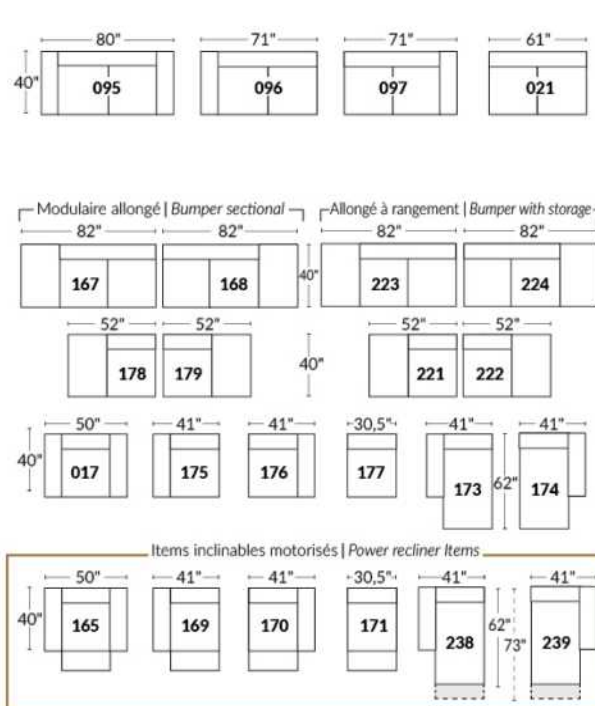

### Autres | Others

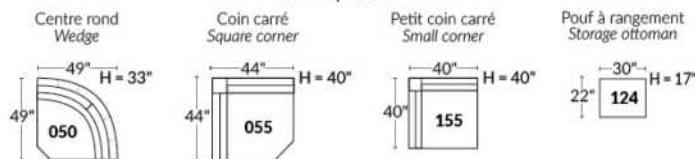

### EXEMPLE 23" EXAMPLE

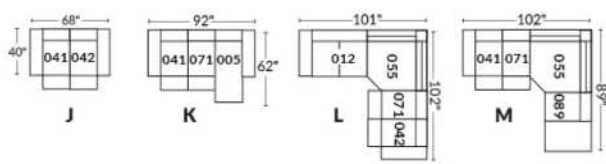

### EXEMPLE 30" EXAMPLE

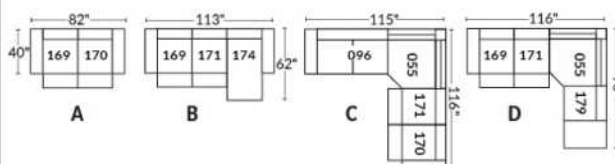

## PORTOFINO

### FEATURES:

- Manual adjustable headrest on all items (2 on square corner & stationary on wedge).
- \*Wall hugger power recliners with full footrest (manual n/a).
- Power recliner lounge chair (manual n/a) with power headrest in option. Wall clearance 8" & front 5".
- Seat cushions with shaped foam + 1" layer of memory foam on top; arm with memory foam.
- Stitching: Small thread in fabric & large flat thread in leather.
- \*Excludes Chairs 043 & 163: Wall clearance 16"

Note: 2 recliner seats separated by a corner can not be opened at the same time. No recliner seats beside #155 Small Square Corner.

### OPTIONS

- Battery Pack: Add \$160/ea.
- \*Motorized headrest: Add \$160 ea. (\*N/A on stationary items).
- Foam: Extra firm add \$15/seat.
- Choice of Large or Small 6" Arm: Leg on LARGE arm: LG103 wood or LG189 metal (Black or Chrome). SMALL Arm: LG08 wood or LG196 metal (Black or Chrome). Specify colour.
- Seat Depth: 20" or \*22". \*22" seat depth N/A on chairs 043 & 163.
- 043 & 163 Chairs: with wood base (specify colour).

### HOME THEATRE Configurations

For Accessories, Cup holders & Configuration details, see Optima Home Theatre page attached.

Accessory Dock : \$35 ea.

Cup Holders: Metal: \$25 ea. | LED lighted Cup Holder: \$25 ea. | \*LED lighted Cup Holder with (1 or 2 motor) controls: \$40 ea.

\*LED Light strip under seat: \$25/seat.

| Description                        | L x D x H   | Leather |                       |  |  |                                  |                           | Fabric |          |           |
|------------------------------------|-------------|---------|-----------------------|--|--|----------------------------------|---------------------------|--------|----------|-----------|
|                                    |             | 10      | 20<br>Madras<br>Softy | 30<br>Hugo<br>Fantasy<br>Illusion<br>Tucson<br>Utah<br>Vintage<br>Wild Laredo<br>Yukon | 40<br>Elegance<br>Princess<br>Santiago<br>Sensation<br>Sunset<br>Trina<br>Victoria | 50<br>Bull<br>Cassiope<br>Dublin | 60<br>Caress<br>Ultrasued | A      | B<br>COM | C<br>alta |
| 001 CHAIR                          | 44x40x33/40 | 1890    | 1980                  | 2070   | 2160   | 2250                             | 2340                      | 1535   | 1580     | 1625      |
| 002 LOVESEAT                       | 67x40x33/40 | 2700    | 2815                  | 2930   | 3045   | 3160                             | 3275                      | 2175   | 2250     | 2325      |
| 003 SOFA                           | 91x40x33/40 | 3265    | 3415                  | 3565   | 3715   | 3865                             | 4015                      | 2625   | 2715     | 2805      |
| 005 LOUNGE CHAIR RIGHT ARM         | 34x62x33/40 | 1765    | 1830                  | 1895   | 1960   | 2025                             | 2090                      | 1410   | 1470     | 1530      |
| 009 ARMLESS LOVESEAT               | 47x40x33/40 | 1895    | 1965                  | 2035   | 2105   | 2175                             | 2245                      | 1490   | 1570     | 1650      |
| 011 LOUNGE CHAIR LEFT ARM          | 34x62x33/40 | 1765    | 1830                  | 1895   | 1960   | 2025                             | 2090                      | 1410   | 1470     | 1530      |
| 012 LOVESEAT LEFT ARM              | 57x40x33/40 | 2320    | 2420                  | 2520   | 2620   | 2720                             | 2820                      | 1850   | 1925     | 2000      |
| 017 DOUBLE CHAIR                   | 51x40x33/40 | 1980    | 2080                  | 2180   | 2280   | 2380                             | 2480                      | 1600   | 1660     | 1720      |
| 021 APARTMENT SOFA NO ARM          | 61x40x33/40 | 2140    | 2240                  | 2340   | 2440   | 2540                             | 2640                      | 1670   | 1755     | 1840      |
| 040 ARMLESS SOFA                   | 71x40x33/40 | 2450    | 2565                  | 2680   | 2795   | 2910                             | 3025                      | 1950   | 2040     | 2130      |
| 041 RECLINING CHAIR LEFT ARM       | 34x40x33/40 | 1885    | 1960                  | 2035   | 2110   | 2185                             | 2260                      | 1605   | 1640     | 1675      |
| 042 RECLINING CHAIR RIGHT ARM      | 34x40x33/40 | 1885    | 1960                  | 2035   | 2110   | 2185                             | 2260                      | 1605   | 1640     | 1675      |
| 043 SWIVEL ROCKING RECLINING CHAIR | 30x34x42    | 2235    | 2345                  | 2455   | 2565   | 2675                             | 2785                      | 1875   | 1920     | 1965      |
| 044 RECLINER CHAIR                 | 44x40x33/40 | 2275    | 2365                  | 2455   | 2545   | 2635                             | 2725                      | 1920   | 1970     | 2020      |
| 045 ARMLESS LOVESEAT BUMPER RIGHT  | 68x40x33/40 | 2245    | 2340                  | 2435   | 2530   | 2625                             | 2720                      | 1785   | 1850     | 1915      |
| 050 WEDGE                          | 49x49x33    | 1645    | 1745                  | 1845   | 1945   | 2045                             | 2145                      | 1210   | 1270     | 1330      |

## PORTOFINO

**FEATURES:**

- Manual adjustable headrest on all items (2 on square corner & stationary on wedge).
- \*Wall hugger power recliners with full footrest (manual n/a).
- Power recliner lounge chair (manual n/a) with power headrest in option. Wall clearance 8" & front 5".
- Seat cushions with shaped foam + 1" layer of memory foam on top; arm with memory foam.
- Stitching: Small thread in fabric & large flat thread in leather.
- \*Excludes Chairs 043 & 163: Wall clearance 16"

Note: 2 recliner seats separated by a corner can not be opened at the same time. No recliner seats beside #155 Small Square Corner.

**OPTIONS**

- Battery Pack: Add \$160/ea.
- \*Motorized headrest: Add \$160 ea. (\*N/A on stationary items).
- Foam: Extra firm add \$15/seat.
- Choice of Large or Small 6" Arm: Leg on LARGE arm: LG103 wood or LG189 metal (Black or Chrome). SMALL Arm: LG08 wood or LG196 metal (Black or Chrome). Specify colour.
- Seat Depth: 20" or \*22". \*22" seat depth N/A on chairs 043 & 163.
- 043 & 163 Chairs: with wood base (specify colour).

**HOME THEATRE Configurations**

For Accessories, Cup holders & Configuration details, see Optima Home Theatre page attached.

Accessory Dock : \$35 ea.

Cup Holders: Metal: \$25 ea. | LED lighted Cup Holder: \$25 ea. | \*LED lighted Cup Holder with (1 or 2 motor) controls: \$40 ea.

\*LED Light strip under seat: \$25/seat.

| Description                      | L x D x H     | Leather |                       |  |  |                                  |                            | Fabric |          |           |
|----------------------------------|---------------|---------|-----------------------|--|--|----------------------------------|----------------------------|--------|----------|-----------|
|                                  |               | 10      | 20<br>Madras<br>Softy | 30<br>Hugo<br>Fantasy<br>Illusion<br>Tucson<br>Utah<br>Vintage<br>Wild Laredo<br>Yukon | 40<br>Elegance<br>Princess<br>Santiago<br>Sensation<br>Sunset<br>Trina<br>Victoria | 50<br>Bull<br>Cassiope<br>Dublin | 60<br>Caresse<br>Ultrasued | A      | B<br>COM | C<br>alta |
| 051 ARMLESS CHAIR                | 23,5x40x33/40 | 1085    | 1135                  | 1185   | 1235   | 1285                             | 1335                       | 845    | 900      | 955       |
| 052 SOFA LEFT ARM                | 81x40x33/40   | 2870    | 3005                  | 3140   | 3275   | 3410                             | 3545                       | 2290   | 2385     | 2480      |
| 053 SOFA RIGHT ARM               | 81x40x33/40   | 2870    | 3005                  | 3140   | 3275   | 3410                             | 3545                       | 2290   | 2385     | 2480      |
| 055 SQUARE CORNER                | 44x44x33/40   | 1915    | 2010                  | 2105   | 2200   | 2295                             | 2390                       | 1510   | 1565     | 1620      |
| 056 CHAIR RIGHT ARM              | 34x40x33/40   | 1510    | 1575                  | 1640   | 1705   | 1770                             | 1835                       | 1200   | 1260     | 1320      |
| 057 CHAIR LEFT ARM               | 34x40x33/40   | 1510    | 1575                  | 1640   | 1705   | 1770                             | 1835                       | 1200   | 1260     | 1320      |
| 061 LOVESEAT RIGHT ARM           | 57x40x33/40   | 2320    | 2420                  | 2520   | 2620   | 2720                             | 2820                       | 1850   | 1925     | 2000      |
| 071 ARMLESS RECLINING CHAIR      | 23,5x40x33/40 | 1470    | 1525                  | 1580   | 1635   | 1690                             | 1745                       | 1250   | 1310     | 1370      |
| 086 ARMLESS LOVESEAT BUMPER LEFT | 68x40x33/40   | 2245    | 2340                  | 2435   | 2530   | 2625                             | 2720                       | 1785   | 1850     | 1915      |
| 088 ARMLESS CHAIR BUMPER LEFT    | 45x40x33/40   | 1440    | 1535                  | 1630   | 1725   | 1820                             | 1915                       | 1130   | 1165     | 1200      |
| 089 ARMLESS CHAIR BUMPER RIGHT   | 45x40x33/40   | 1440    | 1535                  | 1630   | 1725   | 1820                             | 1915                       | 1130   | 1165     | 1200      |
| 095 APARTMENT SOFA               | 81x40x33/40   | 2940    | 3085                  | 3230   | 3375   | 3520                             | 3665                       | 2350   | 2445     | 2540      |
| 096 APARTMENT SOFA LEFT ARM      | 71x40x33/40   | 2570    | 2680                  | 2790   | 2900   | 3010                             | 3120                       | 2020   | 2110     | 2200      |
| 097 APARTMENT SOFA RIGHT ARM     | 71x40x33/40   | 2570    | 2680                  | 2790   | 2900   | 3010                             | 3120                       | 2020   | 2110     | 2200      |
| 124 STORAGE OTTOMAN              | 30x22x17      | 745     | 765                   | 785  | 805  | 825                              | 845                        | 650    | 670      | 690       |
| 138 STRAIGHT ARM                 | 10x36x24.5    | 415     | 450                   | 485  | 520  | 555                              | 590                        | 350    | 365      | 380       |

## PORTOFINO

**FEATURES:**

- Manual adjustable headrest on all items (2 on square corner & stationary on wedge).
- \*Wall hugger power recliners with full footrest (manual n/a).
- Power recliner lounge chair (manual n/a) with power headrest in option. Wall clearance 8" & front 5".
- Seat cushions with shaped foam + 1" layer of memory foam on top; arm with memory foam.
- Stitching: Small thread in fabric & large flat thread in leather.
- \*Excludes Chairs 043 & 163: Wall clearance 16"

Note: 2 recliner seats separated by a corner can not be opened at the same time. No recliner seats beside #155 Small Square Corner.

**OPTIONS**

- Battery Pack: Add \$160/ea.
- \*Motorized headrest: Add \$160 ea. (\*N/A on stationary items).
- Foam: Extra firm add \$15/seat.
- Choice of Large or Small 6" Arm: Leg on LARGE arm: LG103 wood or LG189 metal (Black or Chrome). SMALL Arm: LG08 wood or LG196 metal (Black or Chrome). Specify colour.
- Seat Depth: 20" or \*22". \*22" seat depth N/A on chairs 043 & 163.
- 043 & 163 Chairs: with wood base (specify colour).

**HOME THEATRE Configurations**

For Accessories, Cup holders & Configuration details, see Optima Home Theatre page attached.

Accessory Dock : \$35 ea.

Cup Holders: Metal: \$25 ea. | LED lighted Cup Holder: \$25 ea. | \*LED lighted Cup Holder with (1 or 2 motor) controls: \$40 ea.

\*LED Light strip under seat: \$25/seat.

| Description                            | L x D x H     | Leather |                       |  |  |                                  |                           | Fabric |          |           |
|--|---------------|---------|-----------------------|--|--|----------------------------------|---------------------------|--------|----------|-----------|
|  |               | 10      | 20<br>Madras<br>Softy | 30<br>Hugo<br>Fantasy<br>Illusion<br>Tucson<br>Utah<br>Vintage<br>Wild Laredo<br>Yukon | 40<br>Elegance<br>Princess<br>Santiago<br>Sensation<br>Sunset<br>Trina<br>Victoria | 50<br>Bull<br>Cassiope<br>Dublin | 60<br>Caress<br>Ultrasued | A      | B<br>COM | C<br>alta |
| 155 SMALL SQUARE CORNER                | 40x40x33/40   | 1915    | 2010                  | 2105   | 2200   | 2295                             | 2390                      | 1510   | 1565     | 1620      |
| 159 WEDGE STORAGE                      | 11/27x36x24.5 | 745     | 775                   | 805  | 835  | 865                              | 895                       | 585    | 600      | 615       |
| 160 STRAIGHT STORAGE                   | 11x36x24.5    | 720     | 745                   | 770  | 795  | 820                              | 845                       | 550    | 570      | 590       |
| 163 DBL SWIVEL ROCKING RECLINER CHAIR  | 33x34x42      | 2290    | 2410                  | 2530   | 2650   | 2770                             | 2890                      | 1880   | 1930     | 1980      |
| 165 DOUBLE RECLINING CHAIR             | 51x40x33/40   | 2375    | 2475                  | 2575   | 2675   | 2775                             | 2875                      | 2000   | 2065     | 2130      |
| 167 APARTMENT SOFA NO ARM BUMPER LEFT  | 82x40x33/40   | 2490    | 2620                  | 2750   | 2880   | 3010                             | 3140                      | 1960   | 2045     | 2130      |
| 168 APARTMENT SOFA NO ARM BUMPER RIGHT | 82x40x33/40   | 2490    | 2620                  | 2750   | 2880   | 3010                             | 3140                      | 1960   | 2045     | 2130      |
| 169 DOUBLE RECLINING CHAIR LEFT ARM    | 41x40x33/40   | 1990    | 2070                  | 2150   | 2230   | 2310                             | 2390                      | 1670   | 1750     | 1830      |
| 170 DOUBLE RECLINING CHAIR RIGHT ARM   | 41x40x33/40   | 1990    | 2070                  | 2150   | 2230   | 2310                             | 2390                      | 1670   | 1750     | 1830      |
| 171 ARMLESS DOUBLE RECLINING CHAIR     | 30,5x40x33/40 | 1575    | 1625                  | 1675   | 1725   | 1775                             | 1825                      | 1320   | 1380     | 1440      |
| 173 DOUBLE LOUNGE CHAIR LEFT ARM       | 41x62x33/40   | 1915    | 2005                  | 2095   | 2185   | 2275                             | 2365                      | 1535   | 1615     | 1695      |
| 174 DOUBLE LOUNGE CHAIR RIGHT ARM      | 41x62x33/40   | 1915    | 2005                  | 2095   | 2185   | 2275                             | 2365                      | 1535   | 1615     | 1695      |
| 175 DOUBLE CHAIR LEFT ARM              | 41x40x33/40   | 1590    | 1680                  | 1770   | 1860   | 1950                             | 2040                      | 1285   | 1350     | 1415      |
| 176 DOUBLE CHAIR RIGHT ARM             | 41x40x33/40   | 1590    | 1680                  | 1770   | 1860   | 1950                             | 2040                      | 1285   | 1350     | 1415      |
| 177 ARMLESS DOUBLE CHAIR               | 30,5x40x33/40 | 1185    | 1250                  | 1315   | 1380   | 1445                             | 1510                      | 915    | 970      | 1025      |
| 178 ARMLESS DOUBLE CHAIR BUMPER LEFT   | 52x40x33/40   | 1545    | 1625                  | 1705   | 1785   | 1865                             | 1945                      | 1230   | 1290     | 1350      |



## PORTOFINO

**FEATURES:**

- Manual adjustable headrest on all items (2 on square corner & stationary on wedge).
- \*Wall hugger power recliners with full footrest (manual n/a).
- Power recliner lounge chair (manual n/a) with power headrest in option. Wall clearance 8" & front 5".
- Seat cushions with shaped foam + 1" layer of memory foam on top; arm with memory foam.
- Stitching: Small thread in fabric & large flat thread in leather.
- \*Excludes Chairs 043 & 163: Wall clearance 16"

Note: 2 recliner seats separated by a corner can not be opened at the same time. No recliner seats beside #155 Small Square Corner.

**OPTIONS**

- Battery Pack: Add \$160/ea.
- \*Motorized headrest: Add \$160 ea. (\*N/A on stationary items).
- Foam: Extra firm add \$15/seat.
- Choice of Large or Small 6" Arm: Leg on LARGE arm: LG103 wood or LG189 metal (Black or Chrome). SMALL Arm: LG08 wood or LG196 metal (Black or Chrome). Specify colour.
- Seat Depth: 20" or \*22". \*22" seat depth N/A on chairs 043 & 163.
- 043 & 163 Chairs: with wood base (specify colour).

**HOME THEATRE Configurations**

For Accessories, Cup holders & Configuration details, see Optima Home Theatre page attached.

Accessory Dock : \$35 ea.

Cup Holders: Metal: \$25 ea. | LED lighted Cup Holder: \$25 ea. | \*LED lighted Cup Holder with (1 or 2 motor) controls: \$40 ea.

\*LED Light strip under seat: \$25/seat.

| Description                            | L x D x H       | Leather |                       |  |  |                                  |                           | Fabric |          |           |
|--|-----------------|---------|-----------------------|--|--|----------------------------------|---------------------------|--------|----------|-----------|
|  |                 | 10      | 20<br>Madras<br>Softy | 30<br>Hugo<br>Fantasy<br>Illusion<br>Tucson<br>Utah<br>Vintage<br>Wild Laredo<br>Yukon | 40<br>Elegance<br>Princess<br>Santiago<br>Sensation<br>Sunset<br>Trina<br>Victoria | 50<br>Bull<br>Cassiope<br>Dublin | 60<br>Caress<br>Ultrasued | A      | B<br>COM | C<br>alta |
| 179 ARMLESS DOUBLE CHAIR BUMPER RIGHT  | 52x40x33/40     | 1545    | 1625                  | 1705   | 1785   | 1865                             | 1945                      | 1230   | 1290     | 1350      |
| 186 ARMLESS LOVESEAT BUMPER STORAGE-L  | 68x40x33/40     | 2420    | 2500                  | 2580   | 2660   | 2740                             | 2820                      | 1950   | 2015     | 2080      |
| 187 ARMLESS LOVESEAT BUMPER STORAGE-R  | 68x40x33/40     | 2420    | 2500                  | 2580   | 2660   | 2740                             | 2820                      | 1950   | 2015     | 2080      |
| 188 ARMLESS CHAIR BUMPER STORAGE-L     | 45x40x33/40     | 1600    | 1690                  | 1780   | 1870   | 1960                             | 2050                      | 1295   | 1330     | 1365      |
| 189 ARMLESS CHAIR BUMPER STORAGE-R     | 45x40x33/40     | 1600    | 1690                  | 1780   | 1870   | 1960                             | 2050                      | 1295   | 1330     | 1365      |
| 190 SMALL WEDGE STORAGE                | 11/21x36x24.5   | 720     | 745                   | 770  | 795  | 820                              | 845                       | 550    | 570      | 590       |
| 221 ARMLESS DBL CHAIR BUMPER STORAGE-L | 52x40x33/40     | 1705    | 1790                  | 1875   | 1960   | 2045                             | 2130                      | 1390   | 1450     | 1510      |
| 222 ARMLESS DBL CHAIR BUMPER STORAGE-R | 52x40x33/40     | 1705    | 1790                  | 1875   | 1960   | 2045                             | 2130                      | 1390   | 1450     | 1510      |
| 223 APT SOFA NO ARM BUMPER STORAGE-L   | 82x40x33/40     | 2655    | 2785                  | 2915   | 3045   | 3175                             | 3305                      | 2120   | 2215     | 2310      |
| 224 APT SOFA NO ARM BUMPER STORAGE-R   | 82x40x33/40     | 2655    | 2785                  | 2915   | 3045   | 3175                             | 3305                      | 2120   | 2215     | 2310      |
| 236 RECLINING LOUNGE CHAIR LEFT ARM    | 34x62x33/40     | 2160    | 2225                  | 2290   | 2355   | 2420                             | 2485                      | 1820   | 1880     | 1940      |
| 237 RECLINING LOUNGE CHAIR RIGHT ARM   | 34x62x33/40     | 2160    | 2225                  | 2290   | 2355   | 2420                             | 2485                      | 1820   | 1880     | 1940      |
| 238 RECLINING DBL LOUNGE CHAIR L-ARM   | 41x62x33/40     | 2315    | 2405                  | 2495   | 2585   | 2675                             | 2765                      | 1940   | 2020     | 2100      |
| 239 RECLINING DBL LOUNGE CHAIR R-ARM   | 41x62x33/40     | 2315    | 2405                  | 2495   | 2585   | 2675                             | 2765                      | 1940   | 2020     | 2100      |
| V51 WINE GLASS HOLDER                  | 3.5 x 5.5 x 6.5 | 35      | 35                    | 35   | 35   | 35                               | 35                        | 35     | 35       | 35        |
| V52 PLASTIC SWIVEL TRAY                | 13 3/8 x 9 5/8  | 35      | 35                    | 35   | 35   | 35                               | 35                        | 35     | 35       | 35        |

## PORTOFINO

### FEATURES:

- Manual adjustable headrest on all items (2 on square corner & stationary on wedge).
- \*Wall hugger power recliners with full footrest (manual n/a).
- Power recliner lounge chair (manual n/a) with power headrest in option. Wall clearance 8" & front 5".
- Seat cushions with shaped foam + 1" layer of memory foam on top; arm with memory foam.
- Stitching: Small thread in fabric & large flat thread in leather.
- \*Excludes Chairs 043 & 163: Wall clearance 16"

Note: 2 recliner seats separated by a corner can not be opened at the same time. No recliner seats beside #155 Small Square Corner.

### OPTIONS

- Battery Pack: Add \$160/ea.
- \*Motorized headrest: Add \$160 ea. (\*N/A on stationary items).
- Foam: Extra firm add \$15/seat.
- Choice of Large or Small 6" Arm: Leg on LARGE arm: LG103 wood or LG189 metal (Black or Chrome). SMALL Arm: LG08 wood or LG196 metal (Black or Chrome). Specify colour.
- Seat Depth: 20" or \*22". \*22" seat depth N/A on chairs 043 & 163.
- 043 & 163 Chairs: with wood base (specify colour).

### HOME THEATRE Configurations

For Accessories, Cup holders & Configuration details, see Optima Home Theatre page attached.

Accessory Dock : \$35 ea.

Cup Holders: Metal: \$25 ea. | LED lighted Cup Holder: \$25 ea. | \*LED lighted Cup Holder with (1 or 2 motor) controls: \$40 ea.

\*LED Light strip under seat: \$25/seat.

| Description                 | L x D x H          | Leather |                       |  |  |                                  |                           | Fabric |          |           |
|-----------------------------|--------------------|---------|-----------------------|--|--|----------------------------------|---------------------------|--------|----------|-----------|
|                             |                    | 10      | 20<br>Madras<br>Softy | 30<br>Hugo<br>Fantasy<br>Illusion<br>Tucson<br>Utah<br>Vintage<br>Wild Laredo<br>Yukon | 40<br>Elegance<br>Princess<br>Santiago<br>Sensation<br>Sunset<br>Trina<br>Victoria | 50<br>Bull<br>Cassiope<br>Dublin | 60<br>Caress<br>Ultrasued | A      | B<br>COM | C<br>alta |
| V53 WOOD SWIVEL TRAY        | 19 x 10            | 60      | 60                    | 60   | 60   | 60                               | 60                        | 60     | 60       | 60        |
| V54 TABLET HOLDER           | 4.5 x 8 x 10       | 40      | 40                    | 40   | 40   | 40                               | 40                        | 40     | 40       | 40        |
| V55 LED LAMP                | 1.5x5x14 plié/bent | 35      | 35                    | 35   | 35   | 35                               | 35                        | 35     | 35       | 35        |
| <b>CONFIGURATIONS</b>       |                    |         |                       |  |  |                                  |                           |        |          |           |
| _A CONFIG (169-170)         | 82X40X40           | 3980    | 4140                  | 4300   | 4460   | 4620                             | 4780                      | 3340   | 3500     | 3660      |
| _B CONFIG (169-171-174)     | 113X62X40          | 5480    | 5700                  | 5920   | 6140   | 6360                             | 6580                      | 4525   | 4745     | 4965      |
| _C CONFIG (096-055-171-170) | 115X115X40         | 8050    | 8385                  | 8720   | 9055   | 9390                             | 9725                      | 6520   | 6805     | 7090      |
| _D CONFIG (169-171-055-179) | 115X96X40          | 7025    | 7330                  | 7635   | 7940   | 8245                             | 8550                      | 5730   | 5985     | 6240      |
| _J CONFIG (041-042)         | 68X40X40           | 3770    | 3920                  | 4070   | 4220   | 4370                             | 4520                      | 3210   | 3280     | 3350      |
| _K CONFIG (041-071-005)     | 92X62X40           | 5120    | 5315                  | 5510   | 5705   | 5900                             | 6095                      | 4265   | 4420     | 4575      |
| _L CONFIG (012-055-071-042) | 102X102X40         | 7590    | 7915                  | 8240   | 8565   | 8890                             | 9215                      | 6215   | 6440     | 6665      |
| _M CONFIG (041-071-055-089) | 102X89X40          | 6710    | 7030                  | 7350   | 7670   | 7990                             | 8310                      | 5495   | 5680     | 5865      |



# PORTOFINO

**OPTIMA**  
Collection

**Jaymar**

Conçu et fabriqué fièrement au Canada  
Proudly designed and made in Canada

Nos produits sont fabriqués à la main et des variations mineures peuvent survenir

Our product is hand-made and minor variations can occur.

## SPECIFICATIONS

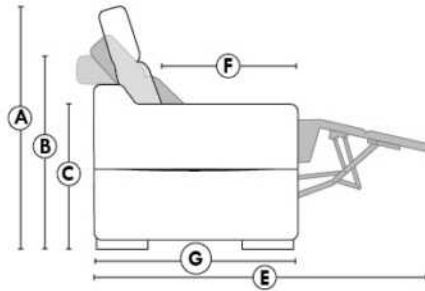

- Appui-tête levé Headrest up
- Appui-tête baissé Headrest down
- Complètement incliné Fully reclined

- A** Hauteur complète 40" Total Height
- B** Hauteur appui-tête baissé 33" Height headrest down
- C** Hauteur du bras 24,5" Arm Height
- D** Hauteur du siège 19,5" Seat height
- E** Profondeur inclinée 65" Depth fully reclined
- F** Profondeur d'assise 20"ou/ou 22" Seat depth
- G** Profondeur appui-tête monté 37,5" Depth with headrest up

## BRAS | ARMS

Option de bras:  
Bras Régulier Large 10" ou Petit bras 6"

Arm option  
Regular arm Large 10" or Small arm 6"

Contrôle de l'inclinaison situé à l'intérieur du bras  
Recliner control located on the inside of the arm.

Option d'accessoires disponible sur le bras régulier seulement  
Accessories option, available on Regular arms ONLY.

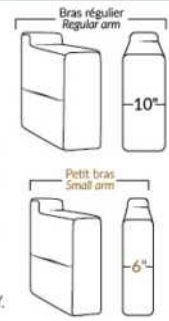

## FAUTEUIL BERÇANT PIVOTANT INCLINABLE SWIVEL ROCKING MOTION CHAIR

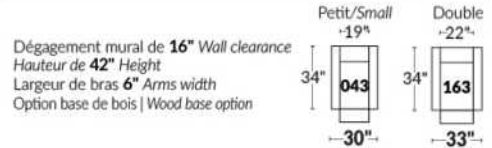

## SIÈGE 23" DE LARGE | 23" SEAT WIDTH

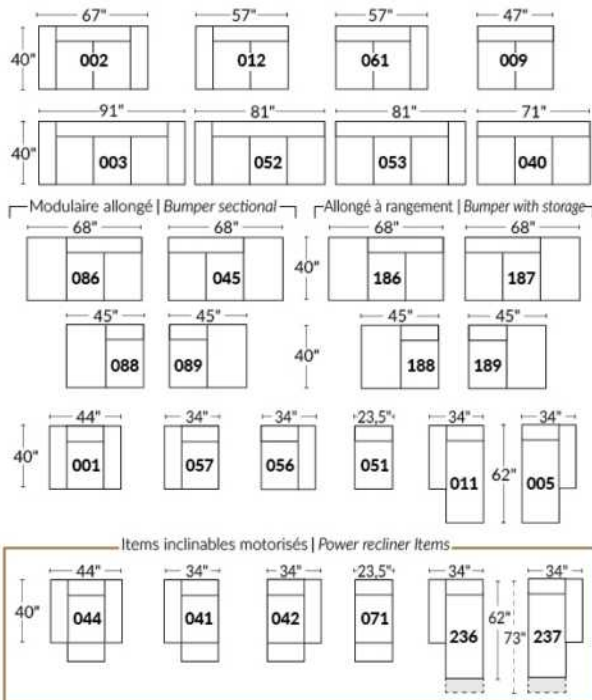

## SIÈGE 30" DE LARGE | 30" SEAT WIDTH

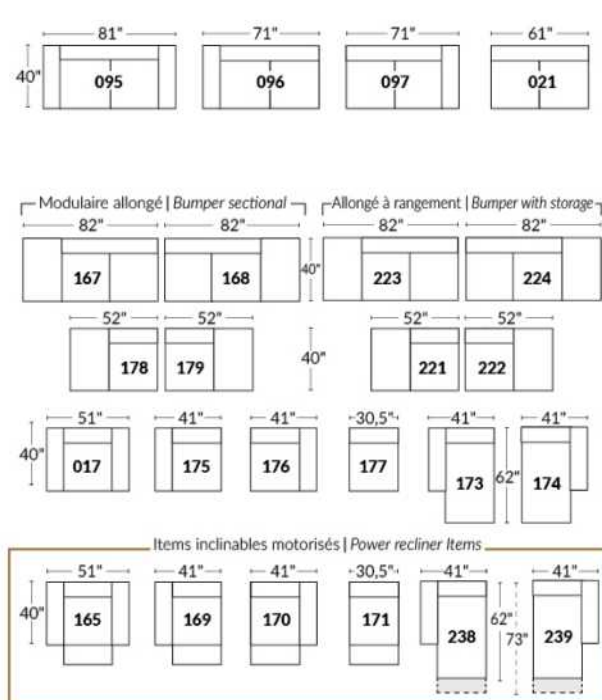

### Autres | Others

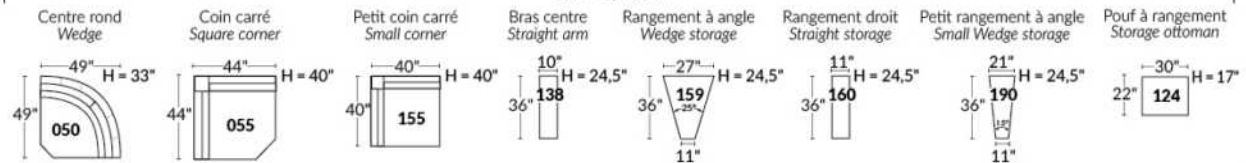

### EXEMPLE 23" EXAMPLE

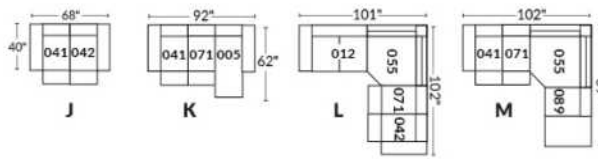

### EXEMPLE 30" EXAMPLE

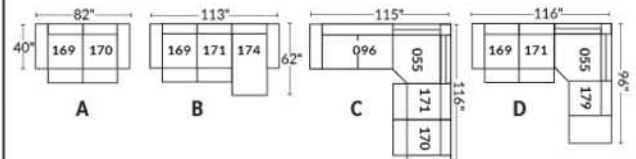

\*Available on certain models and on large arms ONLY.

### OPTIONS CUP HOLDERS

#### METAL



Silver



Matte Black



Brown

#### ILLUMINATED

1.



LED Lighted Cup holder

2.



LED Lighted Cup holder with Single Motor Control, USB Port and LED Base rail

3.



LED Lighted Cup holder with Dual Motor Control, USB Port and LED Base rail

Our illuminated one or two-control cup holders are compatible with LED lights under the seat. You can control the light on the cup holder. The 2 motor cup holder has a reset (home) button control to close your recliner back to its starting position.

#### LED Light under seat (Optional)

Available only in configurations with a minimum of 1 illuminated motorized cup holder with control buttons. The "light" button will control the opening and closing of the light.

For cup holder prices see description section of the Optima model price list.

Please provide us with a drawing of your configuration which indicates the cup holder type and its positioning.

#### Cup holder with controller:

It is important to specify the placement of the cups; on left arm or right arm and which recliner they will control. If you have a row of several seats with cup holders, by default, the controls will be on the left arms and on the right arm for the last outer chair.

#### EXAMPLE A:

041-169: Controller and cup holder on the left arm

071-171: hidden touch sensor buttons on side of seat

042-170: Controller and cup holder on right arm



#### EXAMPLE B:

071-171: These two items can be connected to a smart cup holder which will control the recliner. You must then use one of these items: 138,159, 160 and 190



#### Informations about headrest, controller on reclining seat

#### WITH illuminated cup holder

If you have a **stationary item**, you will have cup holder N°1.

If you have a recliner chair with a **manual headrest**, you will have the cup holder N°2.

If you have a recliner chair with an **electric headrest**, you will have cup holder N°3.

#### Without cup holder and with a reclining seat

If you have a recliner with a **manual headrest** you will have the touch sensor button control on the side of the seat.

If you have a recliner with an **electric headrest** you will have a dual push button controller with USB port on the arm.

If you have an **armless recliner**, you will have the hidden touch sensor button control.



Hidden touch sensor



Dual push button

# OPTIMA

## HOME THEATRE Configurations

\*Available on certain models and on large arms ONLY.

### OPTIONS ACCESSORIES

Accessory Dock



V51  
Wine Glass Holder



V52  
Plastic Swivel Tray Table



V53  
Wood Swivel tray Table  
(Choice of 8 colors)



Specify on which arm (left or right) the tray table will be installed.

V54  
Tablet Holder



V55  
LED Lamp



(For Accessory Dock price, see description section of the Optima model price list and for Accessory item prices, see at very end of the price list)

### Items 138-159-160-190 and large arm.

Accessory docks and cups are Optional. \*Not available on small arms\*

Please specify on which arms you want the accessory docks and cup holders.

NB: Item 138-159-160-190 are unfinished on the sides, must be used between 2 seats.

Each storage item has 2 USB ports and one electrical outlet inside the storage.

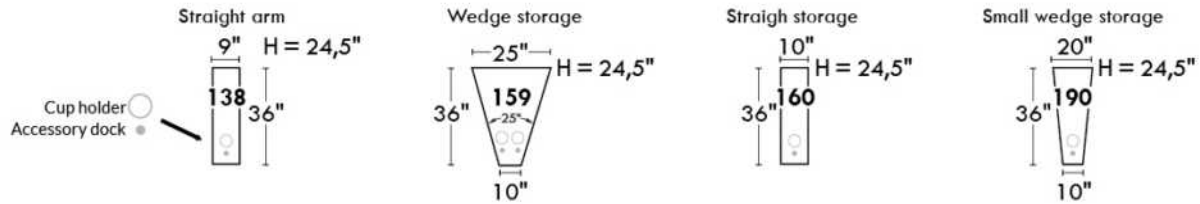

### SUGGESTED CONFIGURATIONS

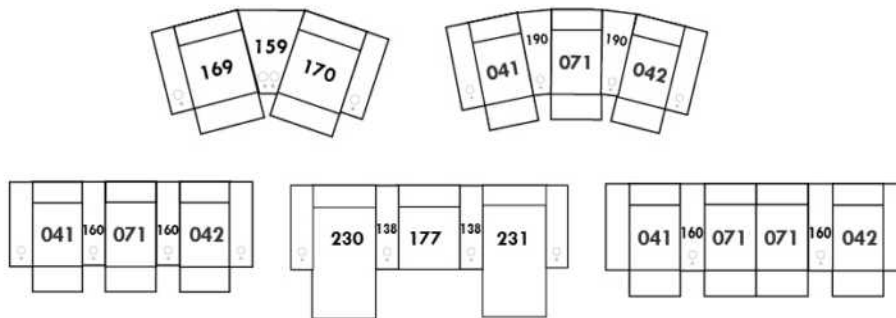

## CDN Price List

### PURE

FEATURES: Seat cushions contain feathers. Back cushions reversible.

LEGS: Specify colour of legs LG107.

COMBO #1: Cover #2 on backs & seats. PRICE: See "Product Knowledge" booklet.

COMBO #2: Cover #2 SEATS in LEATHER ONLY; Grade 10 to 30 add \$60 per seat cushion. Grade 40 to 60 add \$90 per seat cushion. Lounge = 2 seats.

| Description                           | L x D x H | Leather |                       |  |  |                                  |                           | Fabric |          |           |
|---------------------------------------|-----------|---------|-----------------------|--|--|----------------------------------|---------------------------|--------|----------|-----------|
|                                       |           | 10      | 20<br>Madras<br>Softy | 30<br>Hugo<br>Fantasy<br>Illusion<br>Tucson<br>Utah<br>Vintage<br>Wild Laredo<br>Yukon | 40<br>Elegance<br>Princess<br>Santiago<br>Sensation<br>Sunset<br>Trina<br>Victoria | 50<br>Bull<br>Cassiope<br>Dublin | 60<br>Caress<br>Ultrasued | A      | B<br>COM | C<br>alta |
| 002 LOVESEAT                          | 60X41X34  | 2055    | 2165                  | 2275   | 2385   | 2495                             | 2605                      | 1290   | 1350     | 1410      |
| 005 LOUNGE CHAIR RIGHT ARM            | 37X70X34  | 1755    | 1860                  | 1965   | 2070   | 2175                             | 2280                      | 1235   | 1315     | 1395      |
| 009 ARMLESS LOVESEAT                  | 46X41X34  | 1485    | 1600                  | 1715   | 1830   | 1945                             | 2060                      | 1130   | 1195     | 1260      |
| 011 LOUNGE CHAIR LEFT ARM             | 37X70X34  | 1755    | 1860                  | 1965   | 2070   | 2175                             | 2280                      | 1235   | 1315     | 1395      |
| 012 LOVESEAT LEFT ARM                 | 53X41X34  | 1755    | 1865                  | 1975   | 2085   | 2195                             | 2305                      | 1180   | 1275     | 1370      |
| 017 DOUBLE CHAIR                      | 44X41X34  | 1585    | 1660                  | 1735   | 1810   | 1885                             | 1960                      | 1095   | 1150     | 1205      |
| 021 APARTMENT SOFA NO ARM             | 60X41X34  | 1910    | 2040                  | 2170   | 2300   | 2430                             | 2560                      | 1480   | 1560     | 1640      |
| 055 SQUARE CORNER                     | 45X45X34  | 1300    | 1355                  | 1410   | 1465   | 1520                             | 1575                      | 1095   | 1145     | 1195      |
| 061 LOVESEAT RIGHT ARM                | 53X41X34  | 1755    | 1865                  | 1975   | 2085   | 2195                             | 2305                      | 1180   | 1275     | 1370      |
| 095 APARTMENT SOFA                    | 74X41X34  | 2465    | 2610                  | 2755   | 2900   | 3045                             | 3190                      | 1625   | 1710     | 1795      |
| 096 APARTMENT SOFA LEFT ARM           | 67X41X34  | 2165    | 2305                  | 2445   | 2585   | 2725                             | 2865                      | 1540   | 1620     | 1700      |
| 097 APARTMENT SOFA RIGHT ARM          | 67X41X34  | 2165    | 2305                  | 2445   | 2585   | 2725                             | 2865                      | 1540   | 1620     | 1700      |
| 124 STORAGE OTTOMAN                   | 30X22X18  | 760     | 805                   | 850  | 895  | 940                              | 985                       | 705    | 715      | 725       |
| 175 DOUBLE CHAIR LEFT ARM             | 37X41X34  | 1295    | 1360                  | 1425   | 1490   | 1555                             | 1620                      | 1005   | 1070     | 1135      |
| 176 DOUBLE CHAIR RIGHT ARM            | 37X41X34  | 1295    | 1360                  | 1425   | 1490   | 1555                             | 1620                      | 1005   | 1070     | 1135      |
| 177 ARMLESS DOUBLE CHAIR              | 30X41X34  | 1040    | 1120                  | 1200   | 1280   | 1360                             | 1440                      | 945    | 1005     | 1065      |
| 178 ARMLESS DOUBLE CHAIR BUMPER LEFT  | 51X41X34  | 1345    | 1450                  | 1555   | 1660   | 1765                             | 1870                      | 1040   | 1100     | 1160      |
| 179 ARMLESS DOUBLE CHAIR BUMPER RIGHT | 51X41X34  | 1345    | 1450                  | 1555   | 1660   | 1765                             | 1870                      | 1040   | 1100     | 1160      |
| <b>CONFIGURATIONS</b>                 |           |         |                       |  |  |                                  |                           |        |          |           |
| A CONF. A (096-055-176)               | 82X112X34 | 4760    | 5020                  | 5280   | 5540   | 5800                             | 6060                      | 3640   | 3835     | 4030      |
| B CONF. B (178-055-179)               | 96X96X34  | 3990    | 4255                  | 4520   | 4785   | 5050                             | 5315                      | 3175   | 3345     | 3515      |
| C CONF. C (011-177-055-179)           | 112X96X34 | 5440    | 5785                  | 6130   | 6475   | 6820                             | 7165                      | 4315   | 4565     | 4815      |
| D CONF. D (011-097)                   | 104X70X34 | 3920    | 4165                  | 4410   | 4655   | 4900                             | 5145                      | 2775   | 2935     | 3095      |



# PURE



Hauteur complète 34" | Hauteur de siège 18" | Profondeur d'assise 24"  
 Total Height 34" | Seat Height 18" | Seat Depth 24"

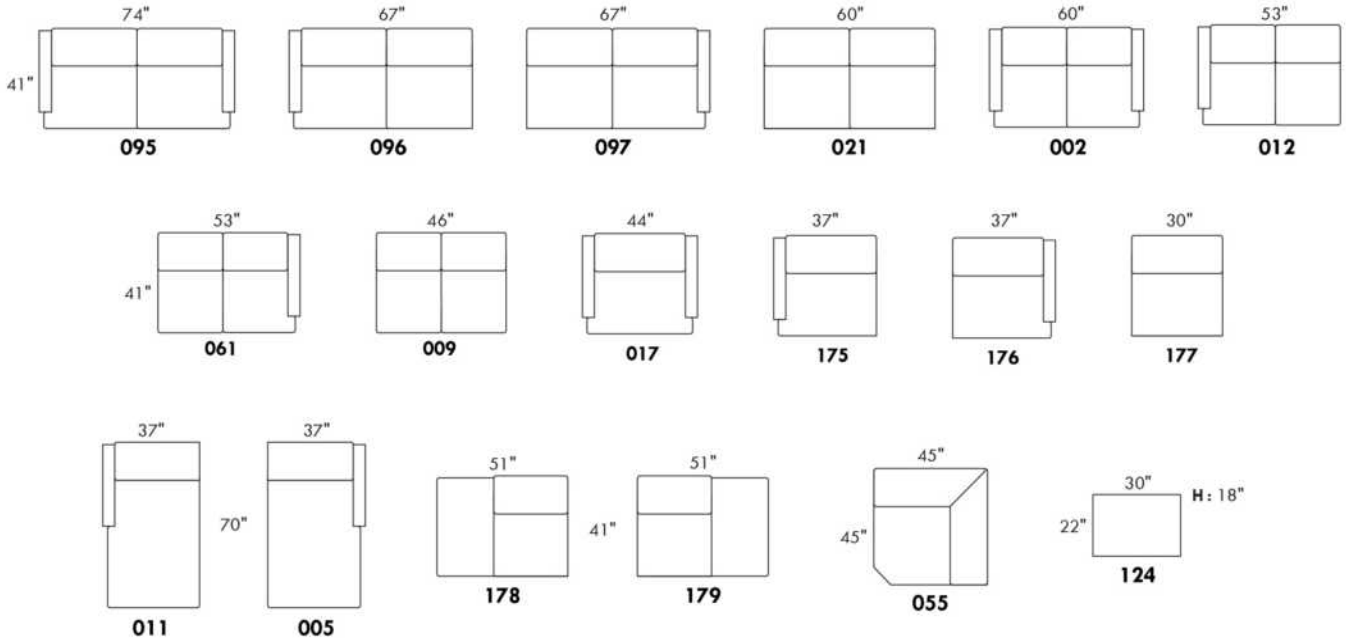

## CONFIGURATIONS

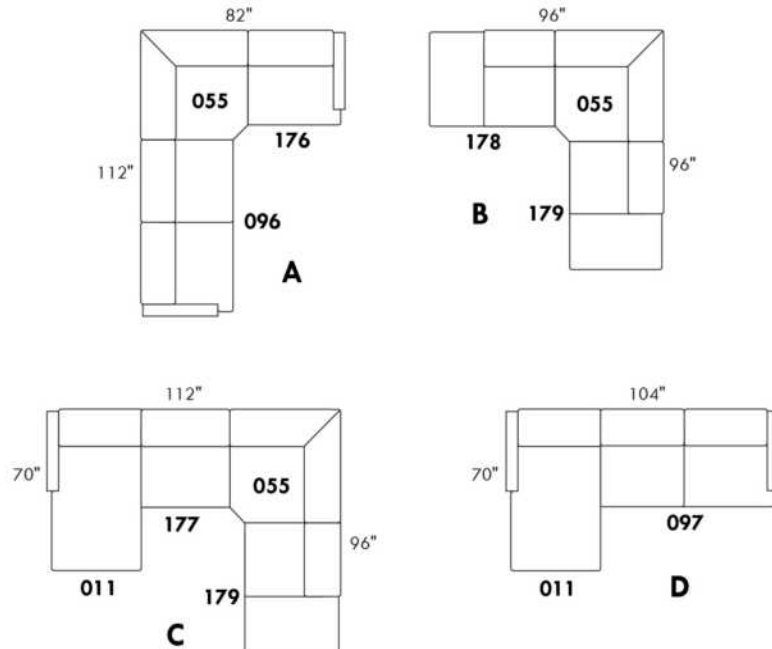

www.jaymar.ca

Toutes les dimensions indiquées sont au pouce près. Nos produits sont fabriqués à la main et des variations mineures peuvent survenir.  
 All dimensions indicated are to the nearest inch. Our product is hand-made and minor variations can occur.

## RIOPEL

LEGS: LG64 metal or LG35 wood (specify colour). / COMBO: Cover #2 on back only.  
1x Removable head-rest included with motion skus 044-041-042 & 071. EXTRA head-rest on non motion back; add \$125/head-rest.  
Specify REGULAR SEATING 21" or DEEP SEATING 22". The following ITEMS are NOT AVAILABLE in DEEP SEATING:  
018-023-046-050-055-062-063 & ALL MOTION skus 044-041-042 & 071.

**OPTIONS:**

With cup holder: \$50/arm; Specify colour: Stainless, Black metal or Antique Gold.  
Upholstery of seat cushions with feathers: Add \$60/seat. Bumper counts as 1 seat, skus 005-011-062 and 063 count as 2 seats each.  
Sofa bed MATTRESS: Regular 4" thick mattress included. OPTIONAL mattresses:  
- 4,5" thick mattress with coils and memory foam with gel: add \$100 or  
- 5" thick mattress with high density foam and memory foam with gel: add \$150.  
Motorized reclining mechanism with TOUCH-SENSOR button add \$160/mechanism.  
WIRELESS (Battery) motorized reclining mechanism add \$320 per mechanism.  
N.B.: 2 reclining seats SEPARATED BY a WEDGE or SQUARE CORNER cannot be opened at the same time.

| Description                       | L x D x H    | Leather |                       |  |  |                                  |                           | Fabric |          |           |
|-----------------------------------|--------------|---------|-----------------------|--|--|----------------------------------|---------------------------|--------|----------|-----------|
|                                   |              | 10      | 20<br>Madras<br>Softy | 30<br>Hugo<br>Fantasy<br>Illusion<br>Tucson<br>Utah<br>Vintage<br>Wild Laredo<br>Yukon | 40<br>Elegance<br>Princess<br>Santiago<br>Sensation<br>Sunset<br>Trina<br>Victoria | 50<br>Bull<br>Cassiope<br>Dublin | 60<br>Caress<br>Ultrasued | A      | B<br>COM | C<br>alta |
| 001 CHAIR                         | 40X37X35     | 1390    | 1485                  | 1580   | 1675   | 1770                             | 1865                      | 995    | 1040     | 1085      |
| 002 LOVESEAT                      | 63X37X35     | 1990    | 2125                  | 2260   | 2395   | 2530                             | 2665                      | 1360   | 1435     | 1510      |
| 003 SOFA                          | 86X37X35     | 2465    | 2635                  | 2805   | 2975   | 3145                             | 3315                      | 1750   | 1845     | 1940      |
| 005 LOUNGE CHAIR RIGHT ARM        | 31.5X61X35   | 1630    | 1740                  | 1850   | 1960   | 2070                             | 2180                      | 1145   | 1225     | 1305      |
| 006 OTTOMAN                       | 25.5X25.5X19 | 630     | 685                   | 740  | 795  | 850                              | 905                       | 535    | 545      | 555       |
| 009 ARMLESS LOVESEAT              | 46X37X35     | 1545    | 1655                  | 1765   | 1875   | 1985                             | 2095                      | 1130   | 1195     | 1260      |
| 011 LOUNGE CHAIR LEFT ARM         | 31.5X61X35   | 1630    | 1740                  | 1850   | 1960   | 2070                             | 2180                      | 1145   | 1225     | 1305      |
| 012 LOVESEAT LEFT ARM             | 54.5X37X35   | 1765    | 1880                  | 1995   | 2110   | 2225                             | 2340                      | 1230   | 1315     | 1400      |
| 018 ANGULAR LOVESEAT LEFT ARM     | 68.5X51X35   | 1875    | 2005                  | 2135   | 2265   | 2395                             | 2525                      | 1335   | 1405     | 1475      |
| 023 ANGULAR LOVESEAT RIGHT ARM    | 68.5X51X35   | 1875    | 2005                  | 2135   | 2265   | 2395                             | 2525                      | 1335   | 1405     | 1475      |
| 040 ARMLESS SOFA                  | 69X37X35     | 2040    | 2185                  | 2330   | 2475   | 2620                             | 2765                      | 1495   | 1600     | 1705      |
| 041 RECLINING CHAIR LEFT ARM      | 31.5X37X43   | 1580    | 1660                  | 1740   | 1820   | 1900                             | 1980                      | 1300   | 1360     | 1420      |
| 042 RECLINING CHAIR RIGHT ARM     | 31.5X37X43   | 1580    | 1660                  | 1740   | 1820   | 1900                             | 1980                      | 1300   | 1360     | 1420      |
| 044 RECLINER CHAIR                | 40X37X43     | 1800    | 1900                  | 2000   | 2100   | 2200                             | 2300                      | 1395   | 1475     | 1555      |
| 045 ARMLESS LOVESEAT BUMPER RIGHT | 66X37X35     | 1795    | 1930                  | 2065   | 2200   | 2335                             | 2470                      | 1255   | 1330     | 1405      |
| 046 ARMLESS ANGULAR LOVESEAT      | 60X51X35     | 1690    | 1805                  | 1920   | 2035   | 2150                             | 2265                      | 1210   | 1295     | 1380      |
| 050 WEDGE                         | 48X48X35     | 1460    | 1545                  | 1630   | 1715   | 1800                             | 1885                      | 1125   | 1170     | 1215      |
| 051 ARMLESS CHAIR                 | 23X37X35     | 945     | 1005                  | 1065   | 1125   | 1185                             | 1245                      | 765    | 815      | 865       |
| 052 SOFA LEFT ARM                 | 77.5X37X35   | 2240    | 2405                  | 2570   | 2735   | 2900                             | 3065                      | 1620   | 1720     | 1820      |
| 053 SOFA RIGHT ARM                | 77.5X37X35   | 2240    | 2405                  | 2570   | 2735   | 2900                             | 3065                      | 1620   | 1720     | 1820      |
| 055 SQUARE CORNER                 | 37X37X35     | 1400    | 1485                  | 1570   | 1655   | 1740                             | 1825                      | 1055   | 1125     | 1195      |
| 056 CHAIR RIGHT ARM               | 31.5X37X35   | 1155    | 1260                  | 1365   | 1470   | 1575                             | 1680                      | 890    | 940      | 990       |



## RIOPEL

LEGS: LG64 metal or LG35 wood (specify colour). / COMBO: Cover #2 on back only.  
1x Removable head-rest included with motion skus 044-041-042 & 071. EXTRA head-rest on non motion back; add \$125/head-rest.  
Specify REGULAR SEATING 21" or DEEP SEATING 22". The following ITEMS are NOT AVAILABLE in DEEP SEATING:  
018-023-046-050-055-062-063 & ALL MOTION skus 044-041-042 & 071.

**OPTIONS:**

With cup holder: \$50/arm; Specify colour: Stainless, Black metal or Antique Gold.  
Upholstery of seat cushions with feathers: Add \$60/seat. Bumper counts as 1 seat, skus 005-011-062 and 063 count as 2 seats each.  
Sofa bed MATTRESS: Regular 4" thick mattress included. OPTIONAL mattresses:  
- 4,5" thick mattress with coils and memory foam with gel: add \$100 or  
- 5" thick mattress with high density foam and memory foam with gel: add \$150.  
Motorized reclining mechanism with TOUCH-SENSOR button add \$160/mechanism.  
WIRELESS (Battery) motorized reclining mechanism add \$320 per mechanism.  
N.B.: 2 reclining seats SEPARATED BY a WEDGE or SQUARE CORNER cannot be opened at the same time.

| Description                      | L x D x H  | Leather |                       |  |  |                                  |                           | Fabric |          |           |
|----------------------------------|------------|---------|-----------------------|--|--|----------------------------------|---------------------------|--------|----------|-----------|
|                                  |            | 10      | 20<br>Madras<br>Softy | 30<br>Hugo<br>Fantasy<br>Illusion<br>Tucson<br>Utah<br>Vintage<br>Wild Laredo<br>Yukon | 40<br>Elegance<br>Princess<br>Santiago<br>Sensation<br>Sunset<br>Trina<br>Victoria | 50<br>Bull<br>Cassiope<br>Dublin | 60<br>Caress<br>Ultrasued | A      | B<br>COM | C<br>alta |
| 057 CHAIR LEFT ARM               | 31.5X37X35 | 1155    | 1260                  | 1365   | 1470   | 1575                             | 1680                      | 890    | 940      | 990       |
| 060 QUEEN SOFA BED               | 86X37X35   | 2855    | 3025                  | 3195   | 3365   | 3535                             | 3705                      | 2130   | 2240     | 2350      |
| 061 LOVESEAT RIGHT ARM           | 54.5X37X35 | 1765    | 1880                  | 1995   | 2110   | 2225                             | 2340                      | 1230   | 1315     | 1400      |
| 062 ANGLE CHAIR LEFT ARM         | 68.5X65X35 | 1690    | 1780                  | 1870   | 1960   | 2050                             | 2140                      | 1180   | 1270     | 1360      |
| 063 ANGLE CHAIR RIGHT ARM        | 68.5X65X35 | 1690    | 1780                  | 1870   | 1960   | 2050                             | 2140                      | 1180   | 1270     | 1360      |
| 071 ARMLESS RECLINING CHAIR      | 23X37X43   | 1345    | 1410                  | 1475   | 1540   | 1605                             | 1670                      | 1175   | 1225     | 1275      |
| 072 SECTIONAL SOFA LEFT ARM      | 91X37X35   | 2650    | 2805                  | 2960   | 3115   | 3270                             | 3425                      | 1870   | 1975     | 2080      |
| 073 SECTIONAL SOFA RIGHT ARM     | 91X37X35   | 2650    | 2805                  | 2960   | 3115   | 3270                             | 3425                      | 1870   | 1975     | 2080      |
| 079 QUEEN SOFA BED NO ARM        | 69X37X35   | 2420    | 2580                  | 2740   | 2900   | 3060                             | 3220                      | 1885   | 1995     | 2105      |
| 080 ANGULAR OTTOMAN              | 36X27X19   | 735     | 760                   | 785  | 810  | 835                              | 860                       | 610    | 620      | 630       |
| 082 QUEEN SOFA BED LEFT ARM      | 77.5X37X35 | 2615    | 2780                  | 2945   | 3110   | 3275                             | 3440                      | 2020   | 2110     | 2200      |
| 083 QUEEN SOFA BED RIGHT ARM     | 77.5X37X35 | 2615    | 2780                  | 2945   | 3110   | 3275                             | 3440                      | 2020   | 2110     | 2200      |
| 086 ARMLESS LOVESEAT BUMPER LEFT | 66X37X35   | 1795    | 1930                  | 2065   | 2200   | 2335                             | 2470                      | 1255   | 1330     | 1405      |
| 088 ARMLESS CHAIR BUMPER LEFT    | 43X37X35   | 1185    | 1285                  | 1385   | 1485   | 1585                             | 1685                      | 905    | 970      | 1035      |
| 089 ARMLESS CHAIR BUMPER RIGHT   | 43X37X35   | 1185    | 1285                  | 1385   | 1485   | 1585                             | 1685                      | 905    | 970      | 1035      |
| 306 OTTOMAN WITH LOUNGE CUSHION  | 24X24X19   | 750     | 805                   | 860  | 915  | 970                              | 1025                      | 620    | 645      | 670       |

# RIOPEL

Hauteur complète 35" | Hauteur de siège 19" | Hauteur devant bras 25" | Profondeur d'assise 21"/22"  
 Total Height 35" | Seat Height 19" | Arm Height 25" | Seat Depth 21"/22"

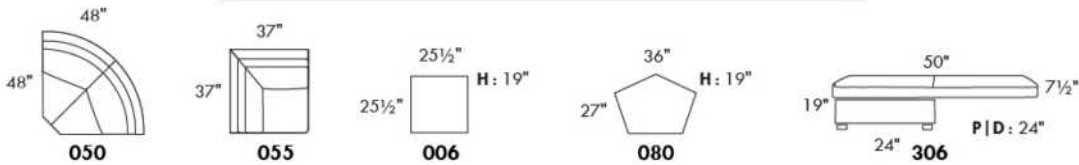
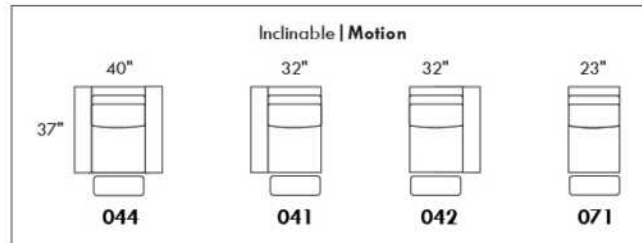
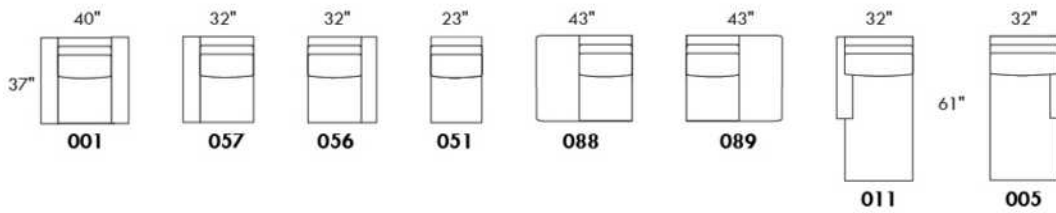
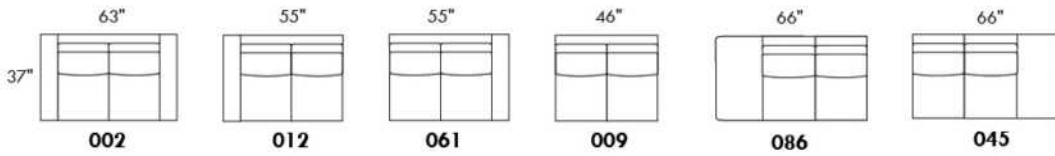
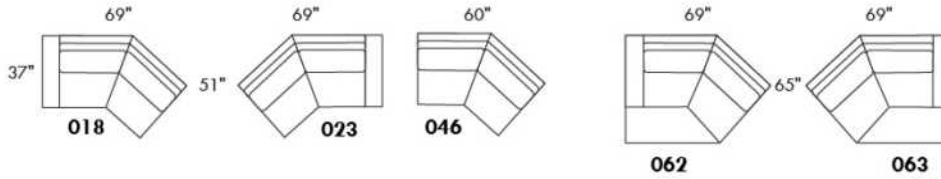
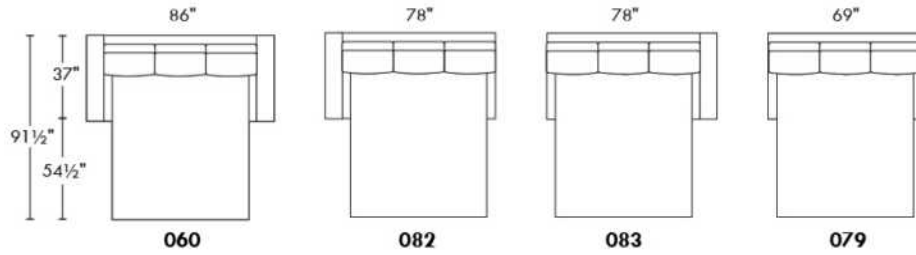
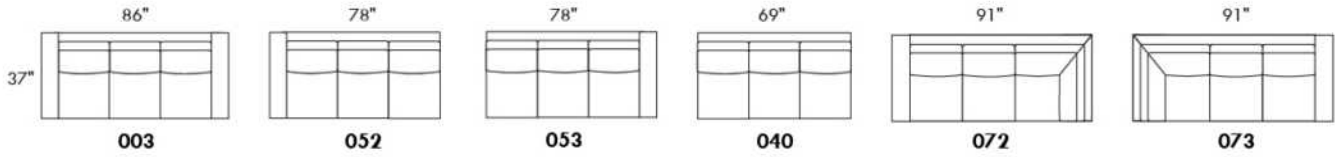

www.jaymar.ca

Toutes les dimensions indiquées sont au pouce près. Nos produits sont fabriqués à la main et des variations mineures peuvent survenir.  
 All dimensions indicated are to the nearest inch. Our product is hand-made and minor variations can occur.



## RODOLFO

Features: Manual adjustable headrest included with all items (2 on square corner). Stitching: French Stitch. In fabric: small thread and in Leather: Large flat thread. Memory foam in arms & seat cushions. Cupholder N/A with this style.

NOTE: 2 recliner seats SEPARATED by a CORNER or a TABLE cannot be opened at the same time.

OPTIONS - Provide SKETCH of your config.:

Small 6" Arm Width: at same price.

Leg (specify colour): On LARGE. Arm: LG187 wood or LG189 metal (Black or Chrome). On SMALL Arm: LG08 wood or LG64 metal.

Table (#154): Specify colour of wood table top.

043 & 163 Chairs: with wood base (specify colour).

**\*\*MANUAL RECLINER N/A.\*\*** Motorized mechanism included in price of recliner chair items. For Battery Pack add \$160/mechanism.

| Description                        | L x D x H     | Leather |                       |  |  |                                  |                           | Fabric |          |           |
|------------------------------------|---------------|---------|-----------------------|--|--|----------------------------------|---------------------------|--------|----------|-----------|
|                                    |               | 10      | 20<br>Madras<br>Softy | 30<br>Hugo<br>Fantasy<br>Illusion<br>Tucson<br>Utah<br>Vintage<br>Wild Laredo<br>Yukon | 40<br>Elegance<br>Princess<br>Santiago<br>Sensation<br>Sunset<br>Trina<br>Victoria | 50<br>Bull<br>Cassiope<br>Dublin | 60<br>Caress<br>Ultrasued | A      | B<br>COM | C<br>alta |
| 001 CHAIR                          | 43x40x30/39   | 1805    | 1910                  | 2015   | 2120   | 2225                             | 2330                      | 1445   | 1495     | 1545      |
| 002 LOVESEAT                       | 66x40x30/39   | 2590    | 2690                  | 2790   | 2890   | 2990                             | 3090                      | 2045   | 2110     | 2175      |
| 003 SOFA                           | 90x40x30/39   | 3095    | 3240                  | 3385   | 3530   | 3675                             | 3820                      | 2450   | 2530     | 2610      |
| 005 LOUNGE CHAIR RIGHT ARM         | 34x62x30/39   | 1635    | 1710                  | 1785   | 1860   | 1935                             | 2010                      | 1295   | 1350     | 1405      |
| 009 ARMLESS LOVESEAT               | 47x40x30/39   | 1800    | 1875                  | 1950   | 2025   | 2100                             | 2175                      | 1390   | 1475     | 1560      |
| 011 LOUNGE CHAIR LEFT ARM          | 34x62x30/39   | 1635    | 1710                  | 1785   | 1860   | 1935                             | 2010                      | 1295   | 1350     | 1405      |
| 012 LOVESEAT LEFT ARM              | 57x40x30/39   | 2185    | 2295                  | 2405   | 2515   | 2625                             | 2735                      | 1725   | 1795     | 1865      |
| 017 DOUBLE CHAIR                   | 50x40x30/39   | 1915    | 2010                  | 2105   | 2200   | 2295                             | 2390                      | 1510   | 1575     | 1640      |
| 021 APARTMENT SOFA NO ARM          | 61x40x30/39   | 2050    | 2145                  | 2240   | 2335   | 2430                             | 2525                      | 1580   | 1660     | 1740      |
| 040 ARMLESS SOFA                   | 71x40x30/39   | 2315    | 2420                  | 2525   | 2630   | 2735                             | 2840                      | 1800   | 1895     | 1990      |
| 041 RECLINING CHAIR LEFT ARM       | 34x40x30/39   | 1780    | 1850                  | 1920   | 1990   | 2060                             | 2130                      | 1495   | 1540     | 1585      |
| 042 RECLINING CHAIR RIGHT ARM      | 34x40x30/39   | 1780    | 1850                  | 1920   | 1990   | 2060                             | 2130                      | 1495   | 1540     | 1585      |
| 043 SWIVEL ROCKING RECLINING CHAIR | 30 x 34 x 42  | 2150    | 2245                  | 2340   | 2435   | 2530                             | 2625                      | 1790   | 1835     | 1880      |
| 044 RECLINER CHAIR                 | 43x40x30/39   | 2165    | 2255                  | 2345   | 2435   | 2525                             | 2615                      | 1810   | 1855     | 1900      |
| 045 ARMLESS LOVESEAT BUMPER RIGHT  | 68x40x30/39   | 2100    | 2210                  | 2320   | 2430   | 2540                             | 2650                      | 1630   | 1710     | 1790      |
| 051 ARMLESS CHAIR                  | 23,5x40x30/39 | 1040    | 1100                  | 1160   | 1220   | 1280                             | 1340                      | 795    | 855      | 915       |
| 052 SOFA LEFT ARM                  | 80x40x30/39   | 2700    | 2835                  | 2970   | 3105   | 3240                             | 3375                      | 2120   | 2210     | 2300      |
| 053 SOFA RIGHT ARM                 | 80x40x30/39   | 2700    | 2835                  | 2970   | 3105   | 3240                             | 3375                      | 2120   | 2210     | 2300      |
| 055 SQUARE CORNER                  | 44x44x30/39   | 1865    | 1965                  | 2065   | 2165   | 2265                             | 2365                      | 1460   | 1515     | 1570      |
| 056 CHAIR RIGHT ARM                | 34x40x30/39   | 1420    | 1495                  | 1570   | 1645   | 1720                             | 1795                      | 1130   | 1165     | 1200      |
| 057 CHAIR LEFT ARM                 | 34x40x30/39   | 1420    | 1495                  | 1570   | 1645   | 1720                             | 1795                      | 1130   | 1165     | 1200      |
| 061 LOVESEAT RIGHT ARM             | 57x40x30/39   | 2185    | 2295                  | 2405   | 2515   | 2625                             | 2735                      | 1725   | 1795     | 1865      |



## RODOLFO

Features: Manual adjustable headrest included with all items (2 on square corner). Stitching: French Stitch. In fabric: small thread and in Leather: Large flat thread. Memory foam in arms & seat cushions. Cupholder N/A with this style.

NOTE: 2 recliner seats SEPARATED by a CORNER or a TABLE cannot be opened at the same time.

OPTIONS - Provide SKETCH of your config.:

Small 6" Arm Width: at same price.

Leg (specify colour): On LARGE. Arm: LG187 wood or LG189 metal (Black or Chrome). On SMALL Arm: LG08 wood or LG64 metal.

Table (#154): Specify colour of wood table top.

043 & 163 Chairs: with wood base (specify colour).

\*\*MANUAL RECLINER N/A.\*\* Motorized mechanism included in price of recliner chair items. For Battery Pack add \$160/mechanism.

| Description                            | L x D x H     | Leather |                       |  |  |                                  |                           | Fabric |          |           |
|--|---------------|---------|-----------------------|--|--|----------------------------------|---------------------------|--------|----------|-----------|
|  |               | 10      | 20<br>Madras<br>Softy | 30<br>Hugo<br>Fantasy<br>Illusion<br>Tucson<br>Utah<br>Vintage<br>Wild Laredo<br>Yukon | 40<br>Elegance<br>Princess<br>Santiago<br>Sensation<br>Sunset<br>Trina<br>Victoria | 50<br>Bull<br>Cassiope<br>Dublin | 60<br>Caress<br>Ultrasued | A      | B<br>COM | C<br>alta |
| 071 ARMLESS RECLINING CHAIR            | 23,5x40x30/39 | 1395    | 1455                  | 1515   | 1575   | 1635                             | 1695                      | 1170   | 1235     | 1300      |
| 086 ARMLESS LOVESEAT BUMPER LEFT       | 68x40x30/39   | 2100    | 2210                  | 2320   | 2430   | 2540                             | 2650                      | 1630   | 1710     | 1790      |
| 088 ARMLESS CHAIR BUMPER LEFT          | 45x40x30/39   | 1340    | 1425                  | 1510   | 1595   | 1680                             | 1765                      | 1040   | 1085     | 1130      |
| 089 ARMLESS CHAIR BUMPER RIGHT         | 45x40x30/39   | 1340    | 1425                  | 1510   | 1595   | 1680                             | 1765                      | 1040   | 1085     | 1130      |
| 095 APARTMENT SOFA                     | 80x40x30/39   | 2815    | 2955                  | 3095   | 3235   | 3375                             | 3515                      | 2215   | 2315     | 2415      |
| 096 APARTMENT SOFA LEFT ARM            | 71x40x30/39   | 2440    | 2570                  | 2700   | 2830   | 2960                             | 3090                      | 1895   | 1980     | 2065      |
| 097 APARTMENT SOFA RIGHT ARM           | 71x40x30/39   | 2440    | 2570                  | 2700   | 2830   | 2960                             | 3090                      | 1895   | 1980     | 2065      |
| 124 STORAGE OTTOMAN                    | 30x22x17      | 705     | 730                   | 755  | 780  | 805                              | 830                       | 605    | 615      | 625       |
| 154 UPHOLSTERED ANGULAR TABLE          | 7/34x32.5x19  | 600     | 625                   | 650  | 675  | 700                              | 725                       | 515    | 530      | 545       |
| 163 DBL SWIVEL ROCKING RECLINER CHAIR  | 33 x 34 x 42  | 2200    | 2315                  | 2430   | 2545   | 2660                             | 2775                      | 1795   | 1840     | 1885      |
| 165 DOUBLE RECLINING CHAIR             | 50x40x30/39   | 2270    | 2365                  | 2460   | 2555   | 2650                             | 2745                      | 1890   | 1965     | 2040      |
| 167 APARTMENT SOFA NO ARM BUMPER LEFT  | 82x40x30/39   | 2350    | 2480                  | 2610   | 2740   | 2870                             | 3000                      | 1820   | 1905     | 1990      |
| 168 APARTMENT SOFA NO ARM BUMPER RIGHT | 82x40x30/39   | 2350    | 2480                  | 2610   | 2740   | 2870                             | 3000                      | 1820   | 1905     | 1990      |
| 169 DOUBLE RECLINING CHAIR LEFT ARM    | 41x40x30/39   | 1885    | 1965                  | 2045   | 2125   | 2205                             | 2285                      | 1560   | 1630     | 1700      |
| 170 DOUBLE RECLINING CHAIR RIGHT ARM   | 41x40x30/39   | 1885    | 1965                  | 2045   | 2125   | 2205                             | 2285                      | 1560   | 1630     | 1700      |
| 171 ARMLESS DOUBLE RECLINING CHAIR     | 30,5x40x30/39 | 1500    | 1555                  | 1610   | 1665   | 1720                             | 1775                      | 1240   | 1305     | 1370      |
| 173 DOUBLE LOUNGE CHAIR LEFT ARM       | 41x62x30/39   | 1790    | 1885                  | 1980   | 2075   | 2170                             | 2265                      | 1395   | 1485     | 1575      |
| 174 DOUBLE LOUNGE CHAIR RIGHT ARM      | 41x62x30/39   | 1790    | 1885                  | 1980   | 2075   | 2170                             | 2265                      | 1395   | 1485     | 1575      |
| 175 DOUBLE CHAIR LEFT ARM              | 41x40x30/39   | 1520    | 1600                  | 1680   | 1760   | 1840                             | 1920                      | 1180   | 1270     | 1360      |
| 176 DOUBLE CHAIR RIGHT ARM             | 41x40x30/39   | 1520    | 1600                  | 1680   | 1760   | 1840                             | 1920                      | 1180   | 1270     | 1360      |
| 177 ARMLESS DOUBLE CHAIR               | 30,5x40x30/39 | 1130    | 1200                  | 1270   | 1340   | 1410                             | 1480                      | 880    | 940      | 1000      |
| 178 ARMLESS DOUBLE CHAIR BUMPER LEFT   | 52x40x30/39   | 1455    | 1540                  | 1625   | 1710   | 1795                             | 1880                      | 1130   | 1180     | 1230      |
| 179 ARMLESS DOUBLE CHAIR BUMPER RIGHT  | 52x40x30/39   | 1455    | 1540                  | 1625   | 1710   | 1795                             | 1880                      | 1130   | 1180     | 1230      |

## CDN Price List

### RODOLFO

| Description                | L x D x H     | Leather |                       |  |  |                                  |                           | Fabric |          |           |
|----------------------------|---------------|---------|-----------------------|--|--|----------------------------------|---------------------------|--------|----------|-----------|
|                            |               | 10      | 20<br>Madras<br>Softy | 30<br>Hugo<br>Fantasy<br>Illusion<br>Tucson<br>Utah<br>Vintage<br>Wild Laredo<br>Yukon | 40<br>Elegance<br>Princess<br>Santiago<br>Sensation<br>Sunset<br>Trina<br>Victoria | 50<br>Bull<br>Cassiope<br>Dublin | 60<br>Caress<br>Ultrasued | A      | B<br>COM | C<br>alta |
| <b>CONFIGURATIONS</b>      |               |         |                       |  |  |                                  |                           |        |          |           |
| A CONFIG (169-170)         | 82X40X30/39   | 3770    | 3930                  | 4090   | 4250   | 4410                             | 4570                      | 3120   | 3260     | 3400      |
| B CONFIG (169-171-174)     | 113X62X30/39  | 5175    | 5405                  | 5635   | 5865   | 6095                             | 6325                      | 4195   | 4420     | 4645      |
| C CONFIG (096-055-171-170) | 115X116X30/39 | 7690    | 8055                  | 8420   | 8785   | 9150                             | 9515                      | 6155   | 6430     | 6705      |
| D CONFIG (169-171-055-179) | 116X96X30/39  | 6705    | 7025                  | 7345   | 7665   | 7985                             | 8305                      | 5390   | 5630     | 5870      |
| J CONFIG (041-042)         | 66X40X30/39   | 3560    | 3700                  | 3840   | 3980   | 4120                             | 4260                      | 2990   | 3080     | 3170      |
| K CONFIG (041-071-005)     | 92X62X30/39   | 4810    | 5015                  | 5220   | 5425   | 5630                             | 5835                      | 3960   | 4125     | 4290      |
| L CONFIG (012-055-071-042) | 101X102X30/39 | 7225    | 7565                  | 7905   | 8245   | 8585                             | 8925                      | 5850   | 6085     | 6320      |
| M CONFIG (041-071-055-089) | 102X89X30/39  | 6380    | 6695                  | 7010   | 7325   | 7640                             | 7955                      | 5165   | 5375     | 5585      |



# RODOLFO

**LINEA 30** Collection



Conçu et fabriqué fièrement au Canada  
Proudly designed and made in Canada

Nos produits sont fabriqués à la main et des variations mineures peuvent survenir

Our product is hand-made and minor variations can occur.

## SPECIFICATIONS

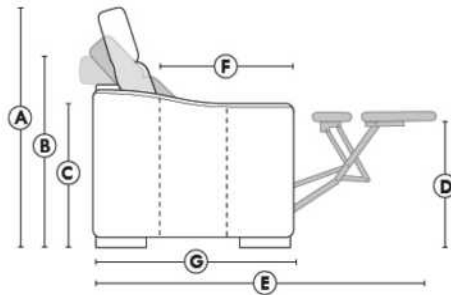

- Appui-tête levé / Headrest up
- Appui-tête baissé / Headrest down
- Complètement incliné / Fully reclined

- A** Hauteur complète 39" Total Height
- B** Hauteur appui-tête baissé 30" Height headrest down
- C** Hauteur du bras 24" Arm Height
- D** Hauteur du siège 19,5" Seat height
- E** Profondeur inclinée 63" Depth fully reclined
- F** Profondeur d'assise 20" Seat depth
- G** Profondeur appui-tête monté 37,5" Depth with headrest up

## BRAS | ARMS

Option de bras:  
Bras Régulier Large 9,5" ou Petit bras 6"

Arm option  
Regular arm Large 9.5" or Small arm 6"

Contrôle de l'inclinaison situé à l'intérieur du bras  
Recliner control located on the inside of the arm.

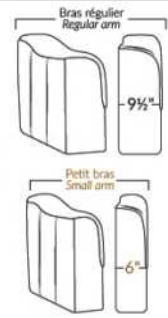

## FAUTEUIL BERÇANT PIVOTANT INCLINABLE SWIVEL ROCKING MOTION CHAIR

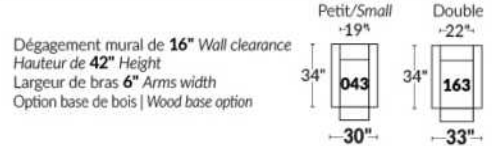

## SIÈGE 23" DE LARGE | 23" SEAT WIDTH

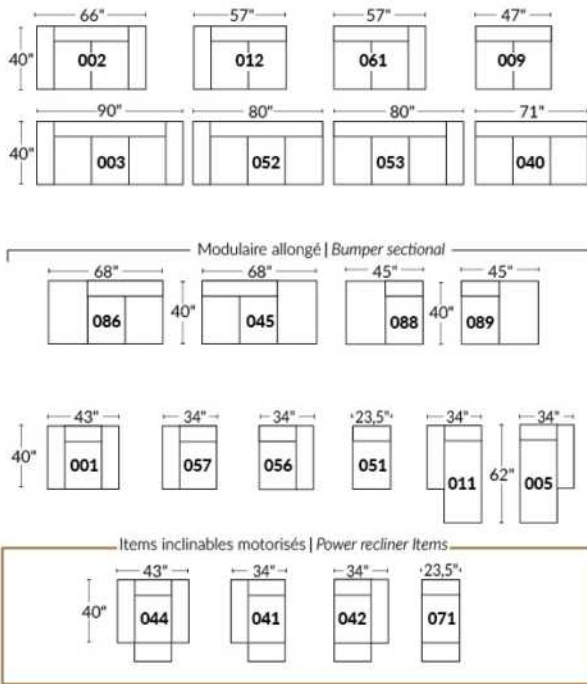

## SIÈGE 30" DE LARGE | 30" SEAT WIDTH

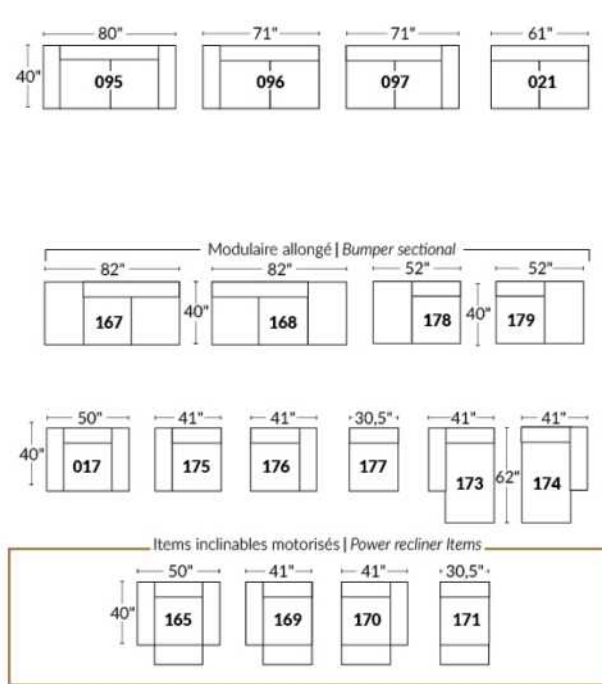

### Autres | Others

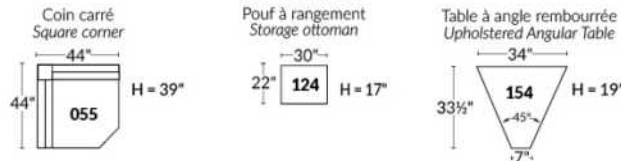

## EXEMPLE 23" EXAMPLE

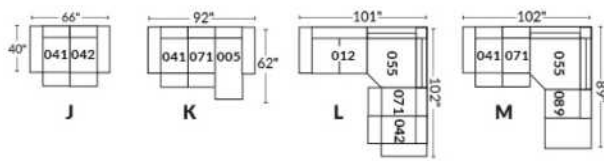

## EXEMPLE 30" EXAMPLE

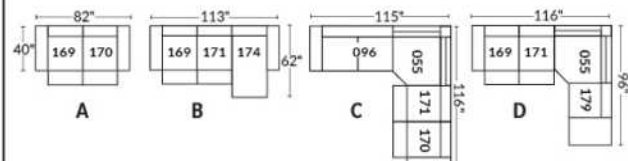

## ROTTERDAM

- Manual adjustable headrest on all items (2 on square corner & stationary on wedge).
- \*Wall hugger power recliners with full footrest (manual n/a).
- Power recliner lounge chair (manual n/a) with power headrest in option. Wall clearance 8" & front 5".
- Seat cushions with shaped foam + 1" layer of memory foam on top; arm with memory foam.
- Stitching: Small thread in fabric & large flat thread in leather.
- \*Excludes 043 & 163 chairs: Wall clearance 16"
- Chairs 043 & 163: arms with NO METAL insert.
- Note: 2 recliner seats separated by a corner can not be opened at the same time. No recliner seats beside #155 Small Square Corner.

### OPTIONS

- Battery Pack: Add \$160/ea.
- \*Motorized headrest: Add \$160 ea. (\*N/A on stationary items).
- Foam: Extra firm add \$15/seat.
- Choice of arms: (Large or the Small 6" Arm which will have no metal insert in arm): Leg on LARGE arm: LG103 wood, Metal: LG189 cyl. (Black or Chrome). SMALL Arm: LG08 wood, Metal: LG196 cyl. (Black or Chrome) or LG64 (sq). Specify colour.
- Seat Depth: 20" or \*22". \*22" seat depth N/A on chairs 043 & 163.
- 043 & 163 Chairs: with wood base (specify colour).

### HOME THEATRE Configurations

For Accessories, Cup holders & Configuration details, see Optima Home Theatre page attached.  
Accessory Dock : \$35 ea.  
Cup Holders: Metal: \$25 ea. | LED lighted Cup Holder: \$25 ea. | \*LED lighted Cup Holder with (1 or 2 motor) controls: \$40 ea.  
\*LED Light strip under seat: \$25/seat.

| Description                        | L x D x H   | Leather |                       |  |  |                                  |                           | Fabric |          |           |
|------------------------------------|-------------|---------|-----------------------|--|--|----------------------------------|---------------------------|--------|----------|-----------|
|                                    |             | 10      | 20<br>Madras<br>Softy | 30<br>Hugo<br>Fantasy<br>Illusion<br>Tucson<br>Utah<br>Vintage<br>Wild Laredo<br>Yukon | 40<br>Elegance<br>Princess<br>Santiago<br>Sensation<br>Sunset<br>Trina<br>Victoria | 50<br>Bull<br>Cassiope<br>Dublin | 60<br>Caress<br>Ultrasued | A      | B<br>COM | C<br>alta |
| 001 CHAIR                          | 44x40x33/40 | 1890    | 1980                  | 2070   | 2160   | 2250                             | 2340                      | 1535   | 1580     | 1625      |
| 002 LOVESEAT                       | 67x40x33/40 | 2700    | 2815                  | 2930   | 3045   | 3160                             | 3275                      | 2175   | 2250     | 2325      |
| 003 SOFA                           | 91x40x33/40 | 3265    | 3415                  | 3565   | 3715   | 3865                             | 4015                      | 2625   | 2715     | 2805      |
| 005 LOUNGE CHAIR RIGHT ARM         | 34x62x33/40 | 1765    | 1830                  | 1895   | 1960   | 2025                             | 2090                      | 1410   | 1470     | 1530      |
| 009 ARMLESS LOVESEAT               | 47x40x33/40 | 1895    | 1965                  | 2035   | 2105   | 2175                             | 2245                      | 1490   | 1570     | 1650      |
| 011 LOUNGE CHAIR LEFT ARM          | 34x62x33/40 | 1765    | 1830                  | 1895   | 1960   | 2025                             | 2090                      | 1410   | 1470     | 1530      |
| 012 LOVESEAT LEFT ARM              | 57x40x33/40 | 2320    | 2420                  | 2520   | 2620   | 2720                             | 2820                      | 1850   | 1925     | 2000      |
| 017 DOUBLE CHAIR                   | 51x40x33/40 | 1980    | 2080                  | 2180   | 2280   | 2380                             | 2480                      | 1600   | 1660     | 1720      |
| 021 APARTMENT SOFA NO ARM          | 61x40x33/40 | 2140    | 2240                  | 2340   | 2440   | 2540                             | 2640                      | 1670   | 1755     | 1840      |
| 040 ARMLESS SOFA                   | 71x40x33/40 | 2450    | 2565                  | 2680   | 2795   | 2910                             | 3025                      | 1950   | 2040     | 2130      |
| 041 RECLINING CHAIR LEFT ARM       | 34x40x33/40 | 1885    | 1960                  | 2035   | 2110   | 2185                             | 2260                      | 1605   | 1640     | 1675      |
| 042 RECLINING CHAIR RIGHT ARM      | 34x40x33/40 | 1885    | 1960                  | 2035   | 2110   | 2185                             | 2260                      | 1605   | 1640     | 1675      |
| 043 SWIVEL ROCKING RECLINING CHAIR | 30x34x42    | 2235    | 2345                  | 2455   | 2565   | 2675                             | 2785                      | 1875   | 1920     | 1965      |
| 044 RECLINER CHAIR                 | 44x40x33/40 | 2275    | 2365                  | 2455   | 2545   | 2635                             | 2725                      | 1920   | 1970     | 2020      |
| 045 ARMLESS LOVESEAT BUMPER RIGHT  | 68x40x33/40 | 2245    | 2340                  | 2435   | 2530   | 2625                             | 2720                      | 1785   | 1850     | 1915      |
| 050 WEDGE                          | 49x49x33    | 1645    | 1745                  | 1845   | 1945   | 2045                             | 2145                      | 1210   | 1270     | 1330      |

## ROTTERDAM

- Manual adjustable headrest on all items (2 on square corner & stationary on wedge).
- \*Wall hugger power recliners with full footrest (manual n/a).
- Power recliner lounge chair (manual n/a) with power headrest in option. Wall clearance 8" & front 5".
- Seat cushions with shaped foam + 1" layer of memory foam on top; arm with memory foam.
- Stitching: Small thread in fabric & large flat thread in leather.

\*Excludes 043 & 163 chairs: Wall clearance 16"

Chairs 043 & 163: arms with NO METAL insert.

Note: 2 recliner seats separated by a corner can not be opened at the same time. No recliner seats beside #155 Small Square Corner.

### OPTIONS

-Battery Pack: Add \$160/ea.

-\*Motorized headrest: Add \$160 ea. (\*N/A on stationary items).

-Foam: Extra firm add \$15/seat.

-Choice of arms: (Large or the Small 6" Arm which will have no metal insert in arm): Leg on LARGE arm: LG103 wood, Metal: LG189 cyl. (Black or Chrome). SMALL Arm: LG08 wood, Metal: LG196 cyl. (Black or Chrome) or LG64 (sq). Specify colour.

-Seat Depth: 20" or \*22". \*22" seat depth N/A on chairs 043 & 163.

-043 & 163 Chairs: with wood base (specify colour).

### HOME THEATRE Configurations

For Accessories, Cup holders & Configuration details, see Optima Home Theatre page attached.

Accessory Dock : \$35 ea.

Cup Holders: Metal: \$25 ea. | LED lighted Cup Holder: \$25 ea. | \*LED lighted Cup Holder with (1 or 2 motor) controls: \$40 ea.

\*LED Light strip under seat: \$25/seat.

| Description                      | L x D x H     | Leather |                       |  |  |                                  |                            | Fabric |          |           |
|----------------------------------|---------------|---------|-----------------------|--|--|----------------------------------|----------------------------|--------|----------|-----------|
|                                  |               | 10      | 20<br>Madras<br>Softy | 30<br>Hugo<br>Fantasy<br>Illusion<br>Tucson<br>Utah<br>Vintage<br>Wild Laredo<br>Yukon | 40<br>Elegance<br>Princess<br>Santiago<br>Sensation<br>Sunset<br>Trina<br>Victoria | 50<br>Bull<br>Cassiope<br>Dublin | 60<br>Caresse<br>Ultrasued | A      | B<br>COM | C<br>alta |
| 051 ARMLESS CHAIR                | 23,5x40x33/40 | 1085    | 1135                  | 1185   | 1235   | 1285                             | 1335                       | 845    | 900      | 955       |
| 052 SOFA LEFT ARM                | 81x40x33/40   | 2870    | 3005                  | 3140   | 3275   | 3410                             | 3545                       | 2290   | 2385     | 2480      |
| 053 SOFA RIGHT ARM               | 81x40x33/40   | 2870    | 3005                  | 3140   | 3275   | 3410                             | 3545                       | 2290   | 2385     | 2480      |
| 055 SQUARE CORNER                | 44x44x33/40   | 1915    | 2010                  | 2105   | 2200   | 2295                             | 2390                       | 1510   | 1565     | 1620      |
| 056 CHAIR RIGHT ARM              | 34x40x33/40   | 1510    | 1575                  | 1640   | 1705   | 1770                             | 1835                       | 1200   | 1260     | 1320      |
| 057 CHAIR LEFT ARM               | 34x40x33/40   | 1510    | 1575                  | 1640   | 1705   | 1770                             | 1835                       | 1200   | 1260     | 1320      |
| 061 LOVESEAT RIGHT ARM           | 57x40x33/40   | 2320    | 2420                  | 2520   | 2620   | 2720                             | 2820                       | 1850   | 1925     | 2000      |
| 071 ARMLESS RECLINING CHAIR      | 23,5x40x33/40 | 1470    | 1525                  | 1580   | 1635   | 1690                             | 1745                       | 1250   | 1310     | 1370      |
| 086 ARMLESS LOVESEAT BUMPER LEFT | 68x40x33/40   | 2245    | 2340                  | 2435   | 2530   | 2625                             | 2720                       | 1785   | 1850     | 1915      |
| 088 ARMLESS CHAIR BUMPER LEFT    | 45x40x33/40   | 1440    | 1535                  | 1630   | 1725   | 1820                             | 1915                       | 1130   | 1165     | 1200      |
| 089 ARMLESS CHAIR BUMPER RIGHT   | 45x40x33/40   | 1440    | 1535                  | 1630   | 1725   | 1820                             | 1915                       | 1130   | 1165     | 1200      |
| 095 APARTMENT SOFA               | 81x40x33/40   | 2940    | 3085                  | 3230   | 3375   | 3520                             | 3665                       | 2350   | 2445     | 2540      |
| 096 APARTMENT SOFA LEFT ARM      | 71x40x33/40   | 2570    | 2680                  | 2790   | 2900   | 3010                             | 3120                       | 2020   | 2110     | 2200      |
| 097 APARTMENT SOFA RIGHT ARM     | 71x40x33/40   | 2570    | 2680                  | 2790   | 2900   | 3010                             | 3120                       | 2020   | 2110     | 2200      |
| 124 STORAGE OTTOMAN              | 30x22x17      | 745     | 765                   | 785  | 805  | 825                              | 845                        | 650    | 670      | 690       |
| 138 STRAIGHT ARM                 | 10x36x24.5    | 415     | 450                   | 485  | 520  | 555                              | 590                        | 350    | 365      | 380       |



## ROTTERDAM

- Manual adjustable headrest on all items (2 on square corner & stationary on wedge).
- \*Wall hugger power recliners with full footrest (manual n/a).
- Power recliner lounge chair (manual n/a) with power headrest in option. Wall clearance 8" & front 5".
- Seat cushions with shaped foam + 1" layer of memory foam on top; arm with memory foam.
- Stitching: Small thread in fabric & large flat thread in leather.
- \*Excludes 043 & 163 chairs: Wall clearance 16"
- Chairs 043 & 163: arms with NO METAL insert.
- Note: 2 recliner seats separated by a corner can not be opened at the same time. No recliner seats beside #155 Small Square Corner.

### OPTIONS

- Battery Pack: Add \$160/ea.
- \*Motorized headrest: Add \$160 ea. (\*N/A on stationary items).
- Foam: Extra firm add \$15/seat.
- Choice of arms: (Large or the Small 6" Arm which will have no metal insert in arm): Leg on LARGE arm: LG103 wood, Metal: LG189 cyl. (Black or Chrome). SMALL Arm: LG08 wood, Metal: LG196 cyl. (Black or Chrome) or LG64 (sq). Specify colour.
- Seat Depth: 20" or \*22". \*22" seat depth N/A on chairs 043 & 163.
- 043 & 163 Chairs: with wood base (specify colour).

### HOME THEATRE Configurations

For Accessories, Cup holders & Configuration details, see Optima Home Theatre page attached.

Accessory Dock : \$35 ea.

Cup Holders: Metal: \$25 ea. | LED lighted Cup Holder: \$25 ea. | \*LED lighted Cup Holder with (1 or 2 motor) controls: \$40 ea.

\*LED Light strip under seat: \$25/seat.

| Description                            | L x D x H     | Leather |                       |  |  |                                  |                           | Fabric |          |           |
|--|---------------|---------|-----------------------|--|--|----------------------------------|---------------------------|--------|----------|-----------|
|  |               | 10      | 20<br>Madras<br>Softy | 30<br>Hugo<br>Fantasy<br>Illusion<br>Tucson<br>Utah<br>Vintage<br>Wild Laredo<br>Yukon | 40<br>Elegance<br>Princess<br>Santiago<br>Sensation<br>Sunset<br>Trina<br>Victoria | 50<br>Bull<br>Cassiope<br>Dublin | 60<br>Caress<br>Ultrasued | A      | B<br>COM | C<br>alta |
| 155 SMALL SQUARE CORNER                | 40x40x33/40   | 1915    | 2010                  | 2105   | 2200   | 2295                             | 2390                      | 1510   | 1565     | 1620      |
| 159 WEDGE STORAGE                      | 11/27x36x24.5 | 745     | 775                   | 805  | 835  | 865                              | 895                       | 585    | 600      | 615       |
| 160 STRAIGHT STORAGE                   | 11x36x24.5    | 720     | 745                   | 770  | 795  | 820                              | 845                       | 550    | 570      | 590       |
| 163 DBL SWIVEL ROCKING RECLINER CHAIR  | 33x34x42      | 2290    | 2410                  | 2530   | 2650   | 2770                             | 2890                      | 1880   | 1930     | 1980      |
| 165 DOUBLE RECLINING CHAIR             | 51x40x33/40   | 2375    | 2475                  | 2575   | 2675   | 2775                             | 2875                      | 2000   | 2065     | 2130      |
| 167 APARTMENT SOFA NO ARM BUMPER LEFT  | 82x40x33/40   | 2490    | 2620                  | 2750   | 2880   | 3010                             | 3140                      | 1960   | 2045     | 2130      |
| 168 APARTMENT SOFA NO ARM BUMPER RIGHT | 82x40x33/40   | 2490    | 2620                  | 2750   | 2880   | 3010                             | 3140                      | 1960   | 2045     | 2130      |
| 169 DOUBLE RECLINING CHAIR LEFT ARM    | 41x40x33/40   | 1990    | 2070                  | 2150   | 2230   | 2310                             | 2390                      | 1670   | 1750     | 1830      |
| 170 DOUBLE RECLINING CHAIR RIGHT ARM   | 41x40x33/40   | 1990    | 2070                  | 2150   | 2230   | 2310                             | 2390                      | 1670   | 1750     | 1830      |
| 171 ARMLESS DOUBLE RECLINING CHAIR     | 30,5x40x33/40 | 1575    | 1625                  | 1675   | 1725   | 1775                             | 1825                      | 1320   | 1380     | 1440      |
| 173 DOUBLE LOUNGE CHAIR LEFT ARM       | 41x62x33/40   | 1915    | 2005                  | 2095   | 2185   | 2275                             | 2365                      | 1535   | 1615     | 1695      |
| 174 DOUBLE LOUNGE CHAIR RIGHT ARM      | 41x62x33/40   | 1915    | 2005                  | 2095   | 2185   | 2275                             | 2365                      | 1535   | 1615     | 1695      |
| 175 DOUBLE CHAIR LEFT ARM              | 41x40x33/40   | 1590    | 1680                  | 1770   | 1860   | 1950                             | 2040                      | 1285   | 1350     | 1415      |
| 176 DOUBLE CHAIR RIGHT ARM             | 41x40x33/40   | 1590    | 1680                  | 1770   | 1860   | 1950                             | 2040                      | 1285   | 1350     | 1415      |
| 177 ARMLESS DOUBLE CHAIR               | 30,5x40x33/40 | 1185    | 1250                  | 1315   | 1380   | 1445                             | 1510                      | 915    | 970      | 1025      |
| 178 ARMLESS DOUBLE CHAIR BUMPER LEFT   | 52x40x33/40   | 1545    | 1625                  | 1705   | 1785   | 1865                             | 1945                      | 1230   | 1290     | 1350      |

## ROTTERDAM

- Manual adjustable headrest on all items (2 on square corner & stationary on wedge).
- \*Wall hugger power recliners with full footrest (manual n/a).
- Power recliner lounge chair (manual n/a) with power headrest in option. Wall clearance 8" & front 5".
- Seat cushions with shaped foam + 1" layer of memory foam on top; arm with memory foam.
- Stitching: Small thread in fabric & large flat thread in leather.
- \*Excludes 043 & 163 chairs: Wall clearance 16"
- Chairs 043 & 163: arms with NO METAL insert.
- Note: 2 recliner seats separated by a corner can not be opened at the same time. No recliner seats beside #155 Small Square Corner.

### OPTIONS

- Battery Pack: Add \$160/ea.
- \*Motorized headrest: Add \$160 ea. (\*N/A on stationary items).
- Foam: Extra firm add \$15/seat.
- Choice of arms: (Large or the Small 6" Arm which will have no metal insert in arm): Leg on LARGE arm: LG103 wood, Metal: LG189 cyl. (Black or Chrome). SMALL Arm: LG08 wood, Metal: LG196 cyl. (Black or Chrome) or LG64 (sq). Specify colour.
- Seat Depth: 20" or \*22". \*22" seat depth N/A on chairs 043 & 163.
- 043 & 163 Chairs: with wood base (specify colour).

### HOME THEATRE Configurations

For Accessories, Cup holders & Configuration details, see Optima Home Theatre page attached.

Accessory Dock : \$35 ea.

Cup Holders: Metal: \$25 ea. | LED lighted Cup Holder: \$25 ea. | \*LED lighted Cup Holder with (1 or 2 motor) controls: \$40 ea.

\*LED Light strip under seat: \$25/seat.

| Description                            | L x D x H       | Leather |                       |  |  |                                  |                           | Fabric |          |           |
|--|-----------------|---------|-----------------------|--|--|----------------------------------|---------------------------|--------|----------|-----------|
|  |                 | 10      | 20<br>Madras<br>Softy | 30<br>Hugo<br>Fantasy<br>Illusion<br>Tucson<br>Utah<br>Vintage<br>Wild Laredo<br>Yukon | 40<br>Elegance<br>Princess<br>Santiago<br>Sensation<br>Sunset<br>Trina<br>Victoria | 50<br>Bull<br>Cassiope<br>Dublin | 60<br>Caress<br>Ultrasued | A      | B<br>COM | C<br>alta |
| 179 ARMLESS DOUBLE CHAIR BUMPER RIGHT  | 52x40x33/40     | 1545    | 1625                  | 1705   | 1785   | 1865                             | 1945                      | 1230   | 1290     | 1350      |
| 186 ARMLESS LOVESEAT BUMPER STORAGE-L  | 68x40x33/40     | 2420    | 2500                  | 2580   | 2660   | 2740                             | 2820                      | 1950   | 2015     | 2080      |
| 187 ARMLESS LOVESEAT BUMPER STORAGE-R  | 68x40x33/40     | 2420    | 2500                  | 2580   | 2660   | 2740                             | 2820                      | 1950   | 2015     | 2080      |
| 188 ARMLESS CHAIR BUMPER STORAGE-L     | 45x40x33/40     | 1600    | 1690                  | 1780   | 1870   | 1960                             | 2050                      | 1295   | 1330     | 1365      |
| 189 ARMLESS CHAIR BUMPER STORAGE-R     | 45x40x33/40     | 1600    | 1690                  | 1780   | 1870   | 1960                             | 2050                      | 1295   | 1330     | 1365      |
| 190 SMALL WEDGE STORAGE                | 11/21x36x24.5   | 720     | 745                   | 770  | 795  | 820                              | 845                       | 550    | 570      | 590       |
| 221 ARMLESS DBL CHAIR BUMPER STORAGE-L | 52x40x33/40     | 1705    | 1790                  | 1875   | 1960   | 2045                             | 2130                      | 1390   | 1450     | 1510      |
| 222 ARMLESS DBL CHAIR BUMPER STORAGE-R | 52x40x33/40     | 1705    | 1790                  | 1875   | 1960   | 2045                             | 2130                      | 1390   | 1450     | 1510      |
| 223 APT SOFA NO ARM BUMPER STORAGE-L   | 82x40x33/40     | 2655    | 2785                  | 2915   | 3045   | 3175                             | 3305                      | 2120   | 2215     | 2310      |
| 224 APT SOFA NO ARM BUMPER STORAGE-R   | 82x40x33/40     | 2655    | 2785                  | 2915   | 3045   | 3175                             | 3305                      | 2120   | 2215     | 2310      |
| 236 RECLINING LOUNGE CHAIR LEFT ARM    | 34x62x33/40     | 2160    | 2225                  | 2290   | 2355   | 2420                             | 2485                      | 1820   | 1880     | 1940      |
| 237 RECLINING LOUNGE CHAIR RIGHT ARM   | 34x62x33/40     | 2160    | 2225                  | 2290   | 2355   | 2420                             | 2485                      | 1820   | 1880     | 1940      |
| 238 RECLINING DBL LOUNGE CHAIR L-ARM   | 41x62x33/40     | 2315    | 2405                  | 2495   | 2585   | 2675                             | 2765                      | 1940   | 2020     | 2100      |
| 239 RECLINING DBL LOUNGE CHAIR R-ARM   | 41x62x33/40     | 2315    | 2405                  | 2495   | 2585   | 2675                             | 2765                      | 1940   | 2020     | 2100      |
| V51 WINE GLASS HOLDER                  | 3.5 x 5.5 x 6.5 | 35      | 35                    | 35   | 35   | 35                               | 35                        | 35     | 35       | 35        |
| V52 PLASTIC SWIVEL TRAY                | 13 3/8 x 9 5/8  | 35      | 35                    | 35   | 35   | 35                               | 35                        | 35     | 35       | 35        |

## ROTTERDAM

- Manual adjustable headrest on all items (2 on square corner & stationary on wedge).
- \*Wall hugger power recliners with full footrest (manual n/a).
- Power recliner lounge chair (manual n/a) with power headrest in option. Wall clearance 8" & front 5".
- Seat cushions with shaped foam + 1" layer of memory foam on top; arm with memory foam.
- Stitching: Small thread in fabric & large flat thread in leather.
- \*Excludes 043 & 163 chairs: Wall clearance 16"
- Chairs 043 & 163: arms with NO METAL insert.
- Note: 2 recliner seats separated by a corner can not be opened at the same time. No recliner seats beside #155 Small Square Corner.

### OPTIONS

- Battery Pack: Add \$160/ea.
- \*Motorized headrest: Add \$160 ea. (\*N/A on stationary items).
- Foam: Extra firm add \$15/seat.
- Choice of arms: (Large or the Small 6" Arm which will have no metal insert in arm): Leg on LARGE arm: LG103 wood, Metal: LG189 cyl. (Black or Chrome). SMALL Arm: LG08 wood, Metal: LG196 cyl. (Black or Chrome) or LG64 (sq). Specify colour.
- Seat Depth: 20" or \*22". \*22" seat depth N/A on chairs 043 & 163.
- 043 & 163 Chairs: with wood base (specify colour).

### HOME THEATRE Configurations

For Accessories, Cup holders & Configuration details, see Optima Home Theatre page attached.

Accessory Dock : \$35 ea.

Cup Holders: Metal: \$25 ea. | LED lighted Cup Holder: \$25 ea. | \*LED lighted Cup Holder with (1 or 2 motor) controls: \$40 ea.

\*LED Light strip under seat: \$25/seat.

| Description                 | L x D x H          | Leather |                       |  |  |                                  |                           | Fabric |          |           |
|-----------------------------|--------------------|---------|-----------------------|--|--|----------------------------------|---------------------------|--------|----------|-----------|
|                             |                    | 10      | 20<br>Madras<br>Softy | 30<br>Hugo<br>Fantasy<br>Illusion<br>Tucson<br>Utah<br>Vintage<br>Wild Laredo<br>Yukon | 40<br>Elegance<br>Princess<br>Santiago<br>Sensation<br>Sunset<br>Trina<br>Victoria | 50<br>Bull<br>Cassiope<br>Dublin | 60<br>Caress<br>Ultrasued | A      | B<br>COM | C<br>alta |
| V53 WOOD SWIVEL TRAY        | 19 x 10            | 65      | 65                    | 65   | 65   | 65                               | 65                        | 65     | 65       | 65        |
| V54 TABLET HOLDER           | 4.5 x 8 x 10       | 40      | 40                    | 40   | 40   | 40                               | 40                        | 40     | 40       | 40        |
| V55 LED LAMP                | 1.5x5x14 plié/bent | 35      | 35                    | 35   | 35   | 35                               | 35                        | 35     | 35       | 35        |
| <b>CONFIGURATIONS</b>       |                    |         |                       |  |  |                                  |                           |        |          |           |
| _A CONFIG (169-170)         | 82X40X40           | 3980    | 4140                  | 4300   | 4460   | 4620                             | 4780                      | 3340   | 3500     | 3660      |
| _B CONFIG (169-171-174)     | 113X62X40          | 5480    | 5700                  | 5920   | 6140   | 6360                             | 6580                      | 4525   | 4745     | 4965      |
| _C CONFIG (096-055-171-170) | 115X115X40         | 8050    | 8385                  | 8720   | 9055   | 9390                             | 9725                      | 6520   | 6805     | 7090      |
| _D CONFIG (169-171-055-179) | 115X96X40          | 7025    | 7330                  | 7635   | 7940   | 8245                             | 8550                      | 5730   | 5985     | 6240      |
| _J CONFIG (041-042)         | 68X40X40           | 3770    | 3920                  | 4070   | 4220   | 4370                             | 4520                      | 3210   | 3280     | 3350      |
| _K CONFIG (041-071-005)     | 92X62X40           | 5120    | 5315                  | 5510   | 5705   | 5900                             | 6095                      | 4265   | 4420     | 4575      |
| _L CONFIG (012-055-071-042) | 102X102X40         | 7590    | 7915                  | 8240   | 8565   | 8890                             | 9215                      | 6215   | 6440     | 6665      |
| _M CONFIG (041-071-055-089) | 102X89X40          | 6710    | 7030                  | 7350   | 7670   | 7990                             | 8310                      | 5495   | 5680     | 5865      |



# ROTTERDAM

**OPTIMA**  
Collection

**Jaymar**

Conçu et fabriqué fièrement au Canada  
Proudly designed and made in Canada

Nos produits sont fabriqués à la main et des variations mineures peuvent survenir

Our product is hand-made and minor variations can occur.

## SPECIFICATIONS

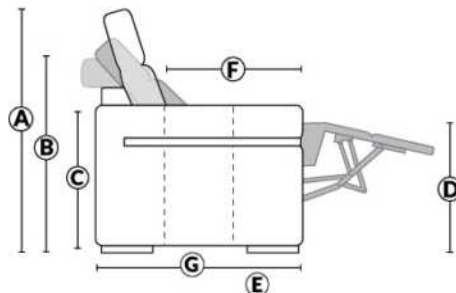

- Appui-tête levé Headrest up
- Appui-tête baissé Headrest down
- Complètement incliné Fully reclined

- A** Hauteur complète 40" Total Height
- B** Hauteur appui-tête baissé 33" Height headrest down
- C** Hauteur du bras 24,5" Arm Height
- D** Hauteur du siège 19,5" Seat height
- E** Profondeur inclinée 65" Depth fully reclined
- F** Profondeur d'assise 20"ou/ou 22" Seat depth
- G** Profondeur appui-tête monté 37,5" Depth with headrest up

## BRAS | ARMS

Option de bras:  
Bras Régulier Large 10" ou Petit bras 6"

Arm option  
Regular arm Large 10" or Small arm 6"

Contrôle de l'inclinaison situé à l'intérieur du bras  
Recliner control located on the inside of the arm.

Option d'accessoires disponible sur le bras régulier seulement  
Accessories option, available on Regular arms ONLY.

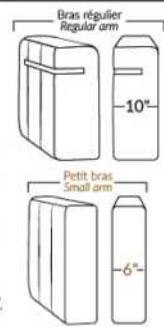

## FAUTEUIL BERÇANT PIVOTANT INCLINABLE SWIVEL ROCKING MOTION CHAIR

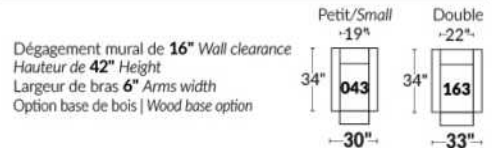

## SIÈGE 23" DE LARGE | 23" SEAT WIDTH

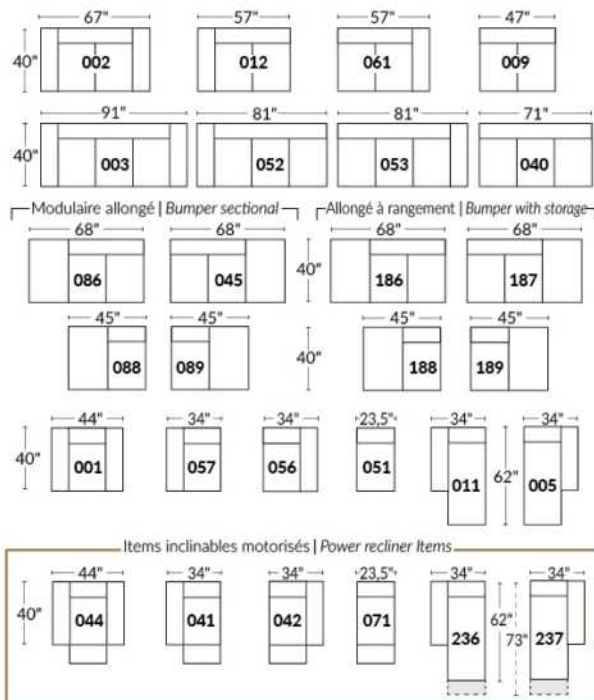

## SIÈGE 30" DE LARGE | 30" SEAT WIDTH

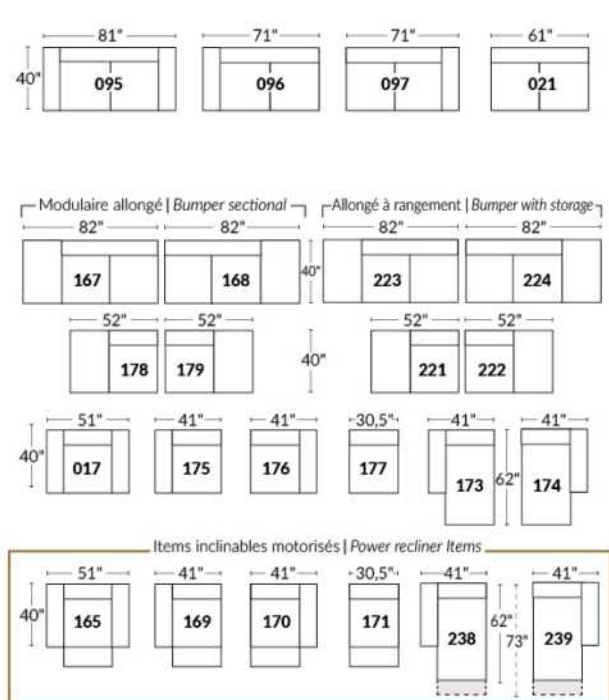

### Autres | Others

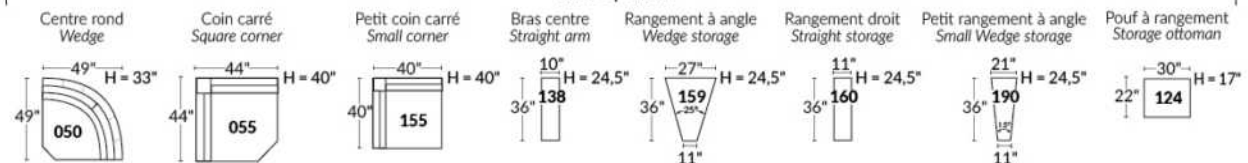

### EXEMPLE 23" EXAMPLE

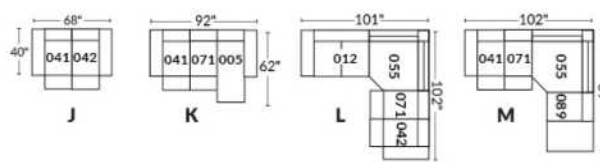

### EXEMPLE 30" EXAMPLE

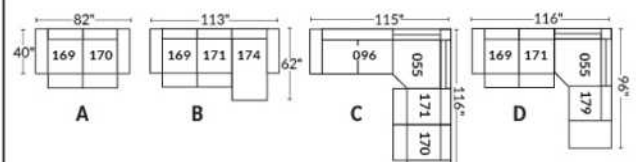

\*Available on certain models and on large arms ONLY.

### OPTIONS CUP HOLDERS

#### METAL



Silver



Matte Black



Brown

#### ILLUMINATED

1.



LED Lighted Cup holder

2.



LED Lighted Cup holder with Single Motor Control, USB Port and LED Base rail

3.



LED Lighted Cup holder with Dual Motor Control, USB Port and LED Base rail

Our illuminated one or two-control cup holders are compatible with LED lights under the seat. You can control the light on the cup holder. The 2 motor cup holder has a reset (home) button control to close your recliner back to its starting position.

#### LED Light under seat (Optional)

Available only in configurations with a minimum of 1 illuminated motorized cup holder with control buttons. The "light" button will control the opening and closing of the light.

For cup holder prices see description section of the Optima model price list.

Please provide us with a drawing of your configuration which indicates the cup holder type and its positioning.

#### Cup holder with controller:

It is important to specify the placement of the cups; on left arm or right arm and which recliner they will control. If you have a row of several seats with cup holders, by default, the controls will be on the left arms and on the right arm for the last outer chair.

#### EXAMPLE A:

041-169: Controller and cup holder on the left arm

071-171: hidden touch sensor buttons on side of seat

042-170: Controller and cup holder on right arm



#### EXAMPLE B:

071-171: These two items can be connected to a smart cup holder which will control the recliner. You must then use one of these items: 138,159, 160 and 190



#### Informations about headrest, controller on reclining seat

#### WITH illuminated cup holder

If you have a **stationary item**, you will have cup holder N°1.

If you have a recliner chair with a **manual headrest**, you will have the cup holder N°2.

If you have a recliner chair with an **electric headrest**, you will have cup holder N°3.

#### Without cup holder and with a reclining seat

If you have a recliner with a **manual headrest** you will have the touch sensor button control on the side of the seat.

If you have a recliner with an **electric headrest** you will have a dual push button controller with USB port on the arm.

If you have an **armless recliner**, you will have the hidden touch sensor button control.



Hidden touch sensor



Dual push button

# OPTIMA

## HOME THEATRE Configurations

\*Available on certain models and on large arms ONLY.

OPTIONS

### ACCESSORIES

Accessory Dock



V51 Wine Glass Holder



V52 Plastic Swivel Tray Table



V53 Wood Swivel tray Table  
(Choice of 8 colors)



Specify on which arm (left or right) the tray table will be installed.

V54 Tablet Holder



V55 LED Lamp



(For Accessory Dock price, see description section of the Optima model price list and for Accessory item prices, see at very end of the price list)

### Items 138-159-160-190 and large arm.

Accessory docks and cups are Optional. \*Not available on small arms\*

Please specify on which arms you want the accessory docks and cup holders.

NB: Item 138-159-160-190 are unfinished on the sides, must be used between 2 seats.

Each storage item has 2 USB ports and one electrical outlet inside the storage.



### SUGGESTED CONFIGURATIONS





## SACHA

Features: Manual adjustable headrest included with all items (2 with square corner). Headrest STATIONARY on Wedge (050). Stitching: Small "French Stitch" in fabric & in leather. Swivel Rocking Recliner Chairs (items 043 & 163 only): seat cushions with 1" memory foam.

PLAIN FABRIC RECOMMENDED.

Note: 2 recliner seats separated by a wedge (050) or square corner (055) cannot be opened at the same time.

OPTIONS - Provide SKETCH of your config.:

Small 6" Arm: at same price.

Leg (specify colour): On LARGE Arm: LG106 wood. On SMALL Arm: LG195 wood.

Choice of Seat Depth: 20" or \*22". The \*22" seat depth N/A on chairs #043 & #163.

043 & 163 Chairs: with wood base (specify colour).

Foam (Extra Firm or Memory): Add \$15/seat. Bumper section counts as 1 seat & lounge chairs as 2 seats.

Motorized recliner mechanism with touch-sensor button add \$160/mechanism. | For Battery Pack: add \$320/mechanism.

| Description                        | L x D x H     | Leather |                       |  |  |                                  |                           | Fabric |          |           |
|------------------------------------|---------------|---------|-----------------------|--|--|----------------------------------|---------------------------|--------|----------|-----------|
|                                    |               | 10      | 20<br>Madras<br>Softy | 30<br>Hugo<br>Fantasy<br>Illusion<br>Tucson<br>Utah<br>Vintage<br>Wild Laredo<br>Yukon | 40<br>Elegance<br>Princess<br>Santiago<br>Sensation<br>Sunset<br>Trina<br>Victoria | 50<br>Bull<br>Cassiope<br>Dublin | 60<br>Caress<br>Ultrasued | A      | B<br>COM | C<br>alta |
| 001 CHAIR                          | 42X 40X33/40  | 1630    | 1725                  | 1820   | 1915   | 2010                             | 2105                      | 1235   | 1295     | 1355      |
| 002 LOVESEAT                       | 65X40X33/40   | 2365    | 2485                  | 2605   | 2725   | 2845                             | 2965                      | 1800   | 1865     | 1930      |
| 003 SOFA                           | 89X40X33/40   | 2890    | 3045                  | 3200   | 3355   | 3510                             | 3665                      | 2180   | 2275     | 2370      |
| 005 LOUNGE CHAIR RIGHT ARM         | 33X62X33/40   | 1555    | 1625                  | 1695   | 1765   | 1835                             | 1905                      | 1155   | 1225     | 1295      |
| 009 ARMLESS LOVESEAT               | 47X40X33/40   | 1770    | 1835                  | 1900   | 1965   | 2030                             | 2095                      | 1330   | 1390     | 1450      |
| 011 LOUNGE CHAIR LEFT ARM          | 33X62X33/40   | 1555    | 1625                  | 1695   | 1765   | 1835                             | 1905                      | 1155   | 1225     | 1295      |
| 012 LOVESEAT LEFT ARM              | 56X40X33/40   | 2070    | 2160                  | 2250   | 2340   | 2430                             | 2520                      | 1575   | 1640     | 1705      |
| 017 DOUBLE CHAIR                   | 49X40X33/40   | 1750    | 1840                  | 1930   | 2020   | 2110                             | 2200                      | 1320   | 1370     | 1420      |
| 021 APARTMENT SOFA NO ARM          | 61X40X33/40   | 2010    | 2090                  | 2170   | 2250   | 2330                             | 2410                      | 1510   | 1600     | 1690      |
| 040 ARMLESS SOFA                   | 71X40X33/40   | 2280    | 2360                  | 2440   | 2520   | 2600                             | 2680                      | 1725   | 1815     | 1905      |
| 041 RECLINING CHAIR LEFT ARM       | 33X40X33/40   | 1505    | 1580                  | 1655   | 1730   | 1805                             | 1880                      | 1175   | 1230     | 1285      |
| 042 RECLINING CHAIR RIGHT ARM      | 33X40X33/40   | 1505    | 1580                  | 1655   | 1730   | 1805                             | 1880                      | 1175   | 1230     | 1285      |
| 043 SWIVEL ROCKING RECLINING CHAIR | 30x34x42      | 1965    | 2060                  | 2155   | 2250   | 2345                             | 2440                      | 1600   | 1645     | 1690      |
| 044 RECLINER CHAIR                 | 42X40X33/40   | 1805    | 1910                  | 2015   | 2120   | 2225                             | 2330                      | 1425   | 1480     | 1535      |
| 045 ARMLESS LOVESEAT BUMPER RIGHT  | 68X40X33/40   | 2080    | 2175                  | 2270   | 2365   | 2460                             | 2555                      | 1580   | 1650     | 1720      |
| 050 WEDGE                          | 49X49X33      | 1555    | 1640                  | 1725   | 1810   | 1895                             | 1980                      | 1100   | 1150     | 1200      |
| 051 ARMLESS CHAIR                  | 23,5X40X33/40 | 1005    | 1055                  | 1105   | 1155   | 1205                             | 1255                      | 765    | 820      | 875       |
| 052 SOFA LEFT ARM                  | 80X40X33/40   | 2590    | 2695                  | 2800   | 2905   | 3010                             | 3115                      | 1950   | 2040     | 2130      |
| 053 SOFA RIGHT ARM                 | 80X40X33/40   | 2590    | 2695                  | 2800   | 2905   | 3010                             | 3115                      | 1950   | 2040     | 2130      |
| 055 SQUARE CORNER                  | 44X44X33/40   | 1825    | 1925                  | 2025   | 2125   | 2225                             | 2325                      | 1390   | 1455     | 1520      |
| 056 CHAIR RIGHT ARM                | 33X40X33/40   | 1320    | 1395                  | 1470   | 1545   | 1620                             | 1695                      | 1000   | 1045     | 1090      |
| 057 CHAIR LEFT ARM                 | 33X40X33/40   | 1320    | 1395                  | 1470   | 1545   | 1620                             | 1695                      | 1000   | 1045     | 1090      |

## SACHA

Features: Manual adjustable headrest included with all items (2 with square corner). Headrest STATIONARY on Wedge (050). Stitching: Small "French Stitch" in fabric & in leather. Swivel Rocking Recliner Chairs (items 043 & 163 only): seat cushions with 1" memory foam.

PLAIN FABRIC RECOMMENDED.

Note: 2 recliner seats separated by a wedge (050) or square corner (055) cannot be opened at the same time.

OPTIONS - Provide SKETCH of your config.:

Small 6" Arm: at same price.

Leg (specify colour): On LARGE Arm: LG106 wood. On SMALL Arm: LG195 wood.

Choice of Seat Depth: 20" or \*22". The \*22" seat depth N/A on chairs #043 & #163.

043 & 163 Chairs: with wood base (specify colour).

Foam (Extra Firm or Memory): Add \$15/seat. Bumper section counts as 1 seat & lounge chairs as 2 seats.

Motorized recliner mechanism with touch-sensor button add \$160/mechanism. | For Battery Pack: add \$320/mechanism.

| Description                            | L x D x H     | Leather |                       |  |  |                                  |                           | Fabric |          |           |
|--|---------------|---------|-----------------------|--|--|----------------------------------|---------------------------|--------|----------|-----------|
|  |               | 10      | 20<br>Madras<br>Softy | 30<br>Hugo<br>Fantasy<br>Illusion<br>Tucson<br>Utah<br>Vintage<br>Wild Laredo<br>Yukon | 40<br>Elegance<br>Princess<br>Santiago<br>Sensation<br>Sunset<br>Trina<br>Victoria | 50<br>Bull<br>Cassiope<br>Dublin | 60<br>Caress<br>Ultrasued | A      | B<br>COM | C<br>alta |
| 061 LOVESEAT RIGHT ARM                 | 56X40X33/40   | 2070    | 2160                  | 2250   | 2340   | 2430                             | 2520                      | 1575   | 1640     | 1705      |
| 071 ARMLESS RECLINING CHAIR            | 23,5X40X33/40 | 1185    | 1250                  | 1315   | 1380   | 1445                             | 1510                      | 955    | 1020     | 1085      |
| 086 ARMLESS LOVESEAT BUMPER LEFT       | 68X40X33/40   | 2080    | 2175                  | 2270   | 2365   | 2460                             | 2555                      | 1580   | 1650     | 1720      |
| 088 ARMLESS CHAIR BUMPER LEFT          | 45X40X33/40   | 1330    | 1410                  | 1490   | 1570   | 1650                             | 1730                      | 1005   | 1050     | 1095      |
| 089 ARMLESS CHAIR BUMPER RIGHT         | 45X40X33/40   | 1330    | 1410                  | 1490   | 1570   | 1650                             | 1730                      | 1005   | 1050     | 1095      |
| 095 APARTMENT SOFA                     | 79X40X33/40   | 2625    | 2780                  | 2935   | 3090   | 3245                             | 3400                      | 1980   | 2070     | 2160      |
| 096 APARTMENT SOFA LEFT ARM            | 70X40X33/40   | 2315    | 2430                  | 2545   | 2660   | 2775                             | 2890                      | 1750   | 1835     | 1920      |
| 097 APARTMENT SOFA RIGHT ARM           | 70X40X33/40   | 2315    | 2430                  | 2545   | 2660   | 2775                             | 2890                      | 1750   | 1835     | 1920      |
| 124 STORAGE OTTOMAN                    | 30X22X17      | 705     | 730                   | 755  | 780  | 805                              | 830                       | 605    | 615      | 625       |
| 163 DBL SWIVEL ROCKING RECLINER CHAIR  | 33 x 34 x 42  | 2010    | 2125                  | 2240   | 2355   | 2470                             | 2585                      | 1605   | 1650     | 1695      |
| 165 DOUBLE RECLINING CHAIR             | 49X40X33/40   | 1920    | 2025                  | 2130   | 2235   | 2340                             | 2445                      | 1495   | 1565     | 1635      |
| 167 APARTMENT SOFA NO ARM BUMPER LEFT  | 82X40X33/40   | 2320    | 2440                  | 2560   | 2680   | 2800                             | 2920                      | 1770   | 1855     | 1940      |
| 168 APARTMENT SOFA NO ARM BUMPER RIGHT | 82X40X33/40   | 2320    | 2440                  | 2560   | 2680   | 2800                             | 2920                      | 1770   | 1855     | 1940      |
| 169 DOUBLE RECLINING CHAIR LEFT ARM    | 40X40X33/40   | 1605    | 1690                  | 1775   | 1860   | 1945                             | 2030                      | 1285   | 1335     | 1385      |
| 170 DOUBLE RECLINING CHAIR RIGHT ARM   | 40X40X33/40   | 1605    | 1690                  | 1775   | 1860   | 1945                             | 2030                      | 1285   | 1335     | 1385      |
| 171 ARMLESS DOUBLE RECLINING CHAIR     | 30,5X40X33/40 | 1305    | 1355                  | 1405   | 1455   | 1505                             | 1555                      | 1085   | 1145     | 1205      |
| 173 DOUBLE LOUNGE CHAIR LEFT ARM       | 40X62X33/40   | 1695    | 1785                  | 1875   | 1965   | 2055                             | 2145                      | 1295   | 1375     | 1455      |
| 174 DOUBLE LOUNGE CHAIR RIGHT ARM      | 40X62X33/40   | 1695    | 1785                  | 1875   | 1965   | 2055                             | 2145                      | 1295   | 1375     | 1455      |
| 175 DOUBLE CHAIR LEFT ARM              | 40X40X33/40   | 1420    | 1500                  | 1580   | 1660   | 1740                             | 1820                      | 1085   | 1145     | 1205      |
| 176 DOUBLE CHAIR RIGHT ARM             | 40X40X33/40   | 1420    | 1500                  | 1580   | 1660   | 1740                             | 1820                      | 1085   | 1145     | 1205      |
| 177 ARMLESS DOUBLE CHAIR               | 30,5X40X33/40 | 1120    | 1175                  | 1230   | 1285   | 1340                             | 1395                      | 845    | 905      | 965       |
| 178 ARMLESS DOUBLE CHAIR BUMPER LEFT   | 52X40X33/40   | 1440    | 1535                  | 1630   | 1725   | 1820                             | 1915                      | 1095   | 1150     | 1205      |



## SACHA

Features: Manual adjustable headrest included with all items (2 with square corner). Headrest STATIONARY on Wedge (050). Stitching: Small "French Stitch" in fabric & in leather. Swivel Rocking Recliner Chairs (items 043 & 163 only): seat cushions with 1" memory foam.

### PLAIN FABRIC RECOMMENDED.

Note: 2 recliner seats separated by a wedge (050) or square corner (055) cannot be opened at the same time.

OPTIONS - Provide SKETCH of your config.:

Small 6" Arm: at same price.

Leg (specify colour): On LARGE Arm: LG106 wood. On SMALL Arm: LG195 wood.

Choice of Seat Depth: 20" or \*22". The \*22" seat depth N/A on chairs #043 & #163.

043 & 163 Chairs: with wood base (specify colour).

Foam (Extra Firm or Memory): Add \$15/seat. Bumper section counts as 1 seat & lounge chairs as 2 seats.

Motorized recliner mechanism with touch-sensor button add \$160/mechanism. | For Battery Pack: add \$320/mechanism.

| Description                           | L x D x H     | Leather |                       |  |  |                                  |                           | Fabric |          |           |
|---------------------------------------|---------------|---------|-----------------------|--|--|----------------------------------|---------------------------|--------|----------|-----------|
|                                       |               | 10      | 20<br>Madras<br>Softy | 30<br>Hugo<br>Fantasy<br>Illusion<br>Tucson<br>Utah<br>Vintage<br>Wild Laredo<br>Yukon | 40<br>Elegance<br>Princess<br>Santiago<br>Sensation<br>Sunset<br>Trina<br>Victoria | 50<br>Bull<br>Cassiope<br>Dublin | 60<br>Caress<br>Ultrasued | A      | B<br>COM | C<br>alta |
| 179 ARMLESS DOUBLE CHAIR BUMPER RIGHT | 52X40X33/40   | 1440    | 1535                  | 1630   | 1725   | 1820                             | 1915                      | 1095   | 1150     | 1205      |
| <b>CONFIGURATIONS</b>                 |               |         |                       |  |  |                                  |                           |        |          |           |
| A CONFIG (169-170)                    | 80X40X33/40   | 3210    | 3380                  | 3550   | 3720   | 3890                             | 4060                      | 2570   | 2670     | 2770      |
| B CONFIG (169-171-174)                | 111X62X33/40  | 4605    | 4830                  | 5055   | 5280   | 5505                             | 5730                      | 3665   | 3855     | 4045      |
| C CONFIG (096-055-171-170)            | 114X115X33/40 | 7050    | 7400                  | 7750   | 8100   | 8450                             | 8800                      | 5510   | 5770     | 6030      |
| D CONFIG (169-171-055-179)            | 115X96X33/40  | 6175    | 6505                  | 6835   | 7165   | 7495                             | 7825                      | 4855   | 5085     | 5315      |
| J CONFIG (041-042)                    | 66X40X33/40   | 3010    | 3160                  | 3310   | 3460   | 3610                             | 3760                      | 2350   | 2460     | 2570      |
| K CONFIG (041-071-005)                | 90X62X33/40   | 4245    | 4455                  | 4665   | 4875   | 5085                             | 5295                      | 3285   | 3475     | 3665      |
| L CONFIG (012-055-071-042)            | 100X101X33/40 | 6585    | 6915                  | 7245   | 7575   | 7905                             | 8235                      | 5095   | 5345     | 5595      |
| M CONFIG (041-071-055-089)            | 101X89X33/40  | 5845    | 6165                  | 6485   | 6805   | 7125                             | 7445                      | 4525   | 4755     | 4985      |



# SACHA

PARALLELE  
Collection 33

Jaymar

Conçu et fabriqué fièrement au Canada  
Proudly designed and made in Canada

Nos produits sont fabriqués à la main et des variations mineures peuvent survenir.

Our product is hand-made and minor variations can occur.

## SPECIFICATIONS

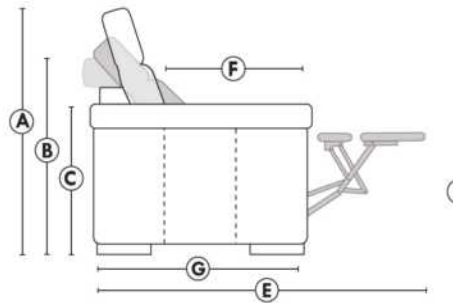

- Appui-tête levé Headrest up
- Appui-tête baissé Headrest down
- Complètement incliné Fully reclined

- A** Hauteur complète 40" Total Height
- B** Hauteur appui-tête baissé 33" Height headrest down
- C** Hauteur du bras 24" Arm Height
- D** Hauteur du siège 19,5" Seat height
- E** Profondeur inclinée 65" Depth fully reclined
- F** Profondeur d'assise 20" ou/ou 22" Seat depth
- G** Profondeur appui-tête monté 37,5" Depth with headrest up

## BRAS | ARMS

Option de bras:  
Bras Régulier Large 9" ou Petit bras 6"

Arm option  
Regular arm Large 9" or Small arm 6"

Contrôle de l'inclinaison situé à l'intérieur du bras  
Recliner control located on the inside of the arm.

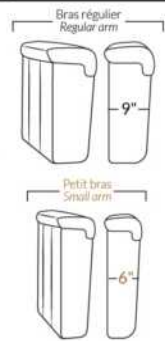

## FAUTEUIL BERÇANT PIVOTANT INCLINABLE SWIVEL ROCKING MOTION CHAIR

Dégagement mural de 16" Wall clearance  
Hauteur de 42" Height  
Largeur de bras 6" Arms width  
Option base de bois | Wood base option

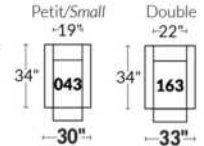

## SIÈGE 23" DE LARGE | 23" SEAT WIDTH

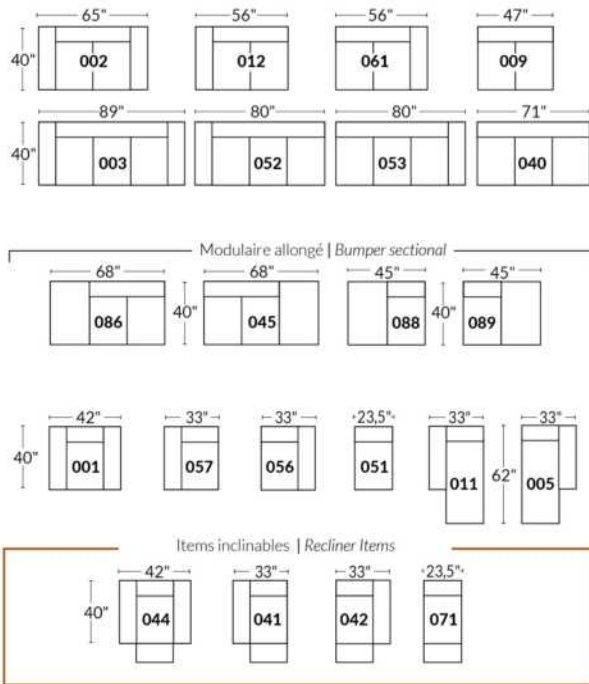

## SIÈGE 30" DE LARGE | 30" SEAT WIDTH

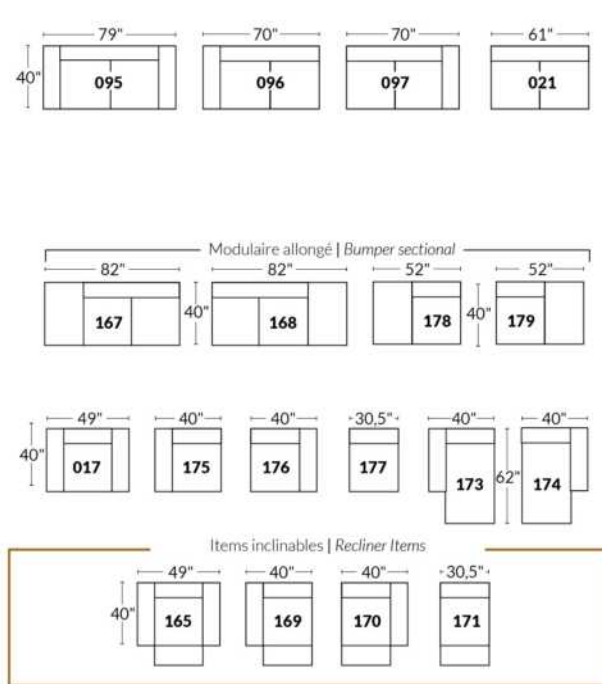

## Autres | Others

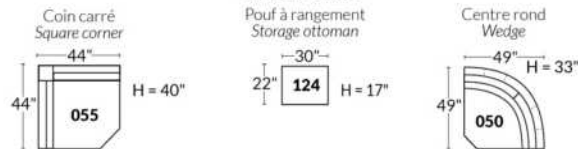

## EXEMPLE 23" EXAMPLE

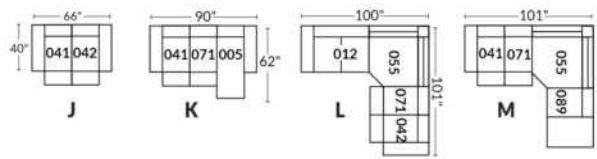

## EXEMPLE 30" EXAMPLE

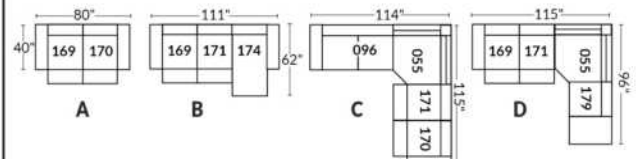

## SAN FRANCISCO

### FEATURES:

- Manual adjustable headrest on all items (2 on square corner & stationary on wedge).
- \*Wall hugger power recliners with full footrest (manual n/a).
- Power recliner lounge chair (manual n/a) with power headrest in option. Wall clearance 8" & front 5".
- Seat cushions with shaped foam + 1" layer of memory foam on top.
- Stitching: Small thread in fabric & large flat thread in leather.
- \*Excludes chairs 043 & 163: Wall clearance 16"

Note: 2 recliner seats separated by a corner can not be opened at the same time. No recliner seats beside #155 Small Square Corner.

### OPTIONS

- Battery Pack: Add \$160/ea.
- \*Motorized headrest: Add \$160 ea. (\*N/A on stationary items).
- Foam: Extra firm add \$15/seat.
- Choice of Large or Small 6" Arm: Leg on LARGE arm: LG08 wood or LG64 metal. SMALL 6" arm: LG195 wood, metal leg N/A. Specify wood colour.
- Seat Depth: 20" or \*22". \*22" seat depth N/A on chairs 043 & 163.
- 043 & 163 Chairs: with wood base (specify colour).

| Description                        | L x D x H     | Leather |                       |  |  |                                  |                           | Fabric |          |           |
|------------------------------------|---------------|---------|-----------------------|--|--|----------------------------------|---------------------------|--------|----------|-----------|
|                                    |               | 10      | 20<br>Madras<br>Softy | 30<br>Hugo<br>Fantasy<br>Illusion<br>Tucson<br>Utah<br>Vintage<br>Wild Laredo<br>Yukon | 40<br>Elegance<br>Princess<br>Santiago<br>Sensation<br>Sunset<br>Trina<br>Victoria | 50<br>Bull<br>Cassiope<br>Dublin | 60<br>Caress<br>Ultrasued | A      | B<br>COM | C<br>alta |
| 001 CHAIR                          | 45x40x33/40   | 1890    | 1980                  | 2070   | 2160   | 2250                             | 2340                      | 1535   | 1580     | 1625      |
| 002 LOVESEAT                       | 68x40x33/40   | 2700    | 2815                  | 2930   | 3045   | 3160                             | 3275                      | 2175   | 2250     | 2325      |
| 003 SOFA                           | 92x40x33/40   | 3265    | 3415                  | 3565   | 3715   | 3865                             | 4015                      | 2625   | 2715     | 2805      |
| 005 LOUNGE CHAIR RIGHT ARM         | 35x62x33/40   | 1765    | 1830                  | 1895   | 1960   | 2025                             | 2090                      | 1410   | 1470     | 1530      |
| 009 ARMLESS LOVESEAT               | 47x40x33/40   | 1895    | 1965                  | 2035   | 2105   | 2175                             | 2245                      | 1490   | 1570     | 1650      |
| 011 LOUNGE CHAIR LEFT ARM          | 35x62x33/40   | 1765    | 1830                  | 1895   | 1960   | 2025                             | 2090                      | 1410   | 1470     | 1530      |
| 012 LOVESEAT LEFT ARM              | 58x40x33/40   | 2320    | 2420                  | 2520   | 2620   | 2720                             | 2820                      | 1850   | 1925     | 2000      |
| 017 DOUBLE CHAIR                   | 52x40x33/40   | 1980    | 2080                  | 2180   | 2280   | 2380                             | 2480                      | 1600   | 1660     | 1720      |
| 021 APARTMENT SOFA NO ARM          | 61x40x33/40   | 2140    | 2240                  | 2340   | 2440   | 2540                             | 2640                      | 1670   | 1755     | 1840      |
| 040 ARMLESS SOFA                   | 71x40x33/40   | 2450    | 2565                  | 2680   | 2795   | 2910                             | 3025                      | 1950   | 2040     | 2130      |
| 041 RECLINING CHAIR LEFT ARM       | 35x40x33/40   | 1885    | 1960                  | 2035   | 2110   | 2185                             | 2260                      | 1605   | 1640     | 1675      |
| 042 RECLINING CHAIR RIGHT ARM      | 35x40x33/40   | 1885    | 1960                  | 2035   | 2110   | 2185                             | 2260                      | 1605   | 1640     | 1675      |
| 043 SWIVEL ROCKING RECLINING CHAIR | 30x34x42      | 2235    | 2345                  | 2455   | 2565   | 2675                             | 2785                      | 1875   | 1920     | 1965      |
| 044 RECLINER CHAIR                 | 45x40x33/40   | 2275    | 2365                  | 2455   | 2545   | 2635                             | 2725                      | 1920   | 1970     | 2020      |
| 045 ARMLESS LOVESEAT BUMPER RIGHT  | 68x40x33/40   | 2245    | 2340                  | 2435   | 2530   | 2625                             | 2720                      | 1785   | 1850     | 1915      |
| 050 WEDGE                          | 49x49x33      | 1645    | 1745                  | 1845   | 1945   | 2045                             | 2145                      | 1210   | 1270     | 1330      |
| 051 ARMLESS CHAIR                  | 23,5x40x33/40 | 1085    | 1135                  | 1185   | 1235   | 1285                             | 1335                      | 845    | 900      | 955       |
| 052 SOFA LEFT ARM                  | 82x40x33/40   | 2870    | 3005                  | 3140   | 3275   | 3410                             | 3545                      | 2290   | 2385     | 2480      |
| 053 SOFA RIGHT ARM                 | 82x40x33/40   | 2870    | 3005                  | 3140   | 3275   | 3410                             | 3545                      | 2290   | 2385     | 2480      |

## SAN FRANCISCO

**FEATURES:**

- Manual adjustable headrest on all items (2 on square corner & stationary on wedge).
- \*Wall hugger power recliners with full footrest (manual n/a).
- Power recliner lounge chair (manual n/a) with power headrest in option. Wall clearance 8" & front 5".
- Seat cushions with shaped foam + 1" layer of memory foam on top.
- Stitching: Small thread in fabric & large flat thread in leather.
- \*Excludes chairs 043 & 163: Wall clearance 16"

Note: 2 recliner seats separated by a corner can not be opened at the same time. No recliner seats beside #155 Small Square Corner.

**OPTIONS**

- Battery Pack: Add \$160/ea.
- \*Motorized headrest: Add \$160 ea. (\*N/A on stationary items).
- Foam: Extra firm add \$15/seat.
- Choice of Large or Small 6" Arm: Leg on LARGE arm: LG08 wood or LG64 metal. SMALL 6" arm: LG195 wood, metal leg N/A. Specify wood colour.
- Seat Depth: 20" or \*22". \*22" seat depth N/A on chairs 043 & 163.
- 043 & 163 Chairs: with wood base (specify colour).

| Description                            | L x D x H     | Leather |                       |  |  |                                  |                           | Fabric |          |           |
|--|---------------|---------|-----------------------|--|--|----------------------------------|---------------------------|--------|----------|-----------|
|  |               | 10      | 20<br>Madras<br>Softy | 30<br>Hugo<br>Fantasy<br>Illusion<br>Tucson<br>Utah<br>Vintage<br>Wild Laredo<br>Yukon | 40<br>Elegance<br>Princess<br>Santiago<br>Sensation<br>Sunset<br>Trina<br>Victoria | 50<br>Bull<br>Cassiope<br>Dublin | 60<br>Caress<br>Ultrasued | A      | B<br>COM | C<br>alta |
| 055 SQUARE CORNER                      | 44x44x33/40   | 1915    | 2010                  | 2105   | 2200   | 2295                             | 2390                      | 1510   | 1565     | 1620      |
| 056 CHAIR RIGHT ARM                    | 35x40x33/40   | 1510    | 1575                  | 1640   | 1705   | 1770                             | 1835                      | 1200   | 1260     | 1320      |
| 057 CHAIR LEFT ARM                     | 35x40x33/40   | 1510    | 1575                  | 1640   | 1705   | 1770                             | 1835                      | 1200   | 1260     | 1320      |
| 061 LOVESEAT RIGHT ARM                 | 58x40x33/40   | 2320    | 2420                  | 2520   | 2620   | 2720                             | 2820                      | 1850   | 1925     | 2000      |
| 071 ARMLESS RECLINING CHAIR            | 23,5x40x33/40 | 1470    | 1525                  | 1580   | 1635   | 1690                             | 1745                      | 1250   | 1310     | 1370      |
| 086 ARMLESS LOVESEAT BUMPER LEFT       | 68x40x33/40   | 2245    | 2340                  | 2435   | 2530   | 2625                             | 2720                      | 1785   | 1850     | 1915      |
| 088 ARMLESS CHAIR BUMPER LEFT          | 45x40x33/40   | 1440    | 1535                  | 1630   | 1725   | 1820                             | 1915                      | 1130   | 1165     | 1200      |
| 089 ARMLESS CHAIR BUMPER RIGHT         | 45x40x33/40   | 1440    | 1535                  | 1630   | 1725   | 1820                             | 1915                      | 1130   | 1165     | 1200      |
| 095 APARTMENT SOFA                     | 82x40x33/40   | 2940    | 3085                  | 3230   | 3375   | 3520                             | 3665                      | 2350   | 2445     | 2540      |
| 096 APARTMENT SOFA LEFT ARM            | 72x40x33/40   | 2570    | 2680                  | 2790   | 2900   | 3010                             | 3120                      | 2020   | 2110     | 2200      |
| 097 APARTMENT SOFA RIGHT ARM           | 72x40x33/40   | 2570    | 2680                  | 2790   | 2900   | 3010                             | 3120                      | 2020   | 2110     | 2200      |
| 124 STORAGE OTTOMAN                    | 30x22x17      | 745     | 765                   | 785  | 805  | 825                              | 845                       | 650    | 670      | 690       |
| 155 SMALL SQUARE CORNER                | 40x40x33/40   | 1915    | 2010                  | 2105   | 2200   | 2295                             | 2390                      | 1510   | 1565     | 1620      |
| 163 DBL SWIVEL ROCKING RECLINER CHAIR  | 33x34x42      | 2290    | 2410                  | 2530   | 2650   | 2770                             | 2890                      | 1880   | 1930     | 1980      |
| 165 DOUBLE RECLINING CHAIR             | 52x40x33/40   | 2375    | 2475                  | 2575   | 2675   | 2775                             | 2875                      | 2000   | 2065     | 2130      |
| 167 APARTMENT SOFA NO ARM BUMPER LEFT  | 82x40x33/40   | 2490    | 2620                  | 2750   | 2880   | 3010                             | 3140                      | 1960   | 2045     | 2130      |
| 168 APARTMENT SOFA NO ARM BUMPER RIGHT | 82x40x33/40   | 2490    | 2620                  | 2750   | 2880   | 3010                             | 3140                      | 1960   | 2045     | 2130      |
| 169 DOUBLE RECLINING CHAIR LEFT ARM    | 42x40x33/40   | 1990    | 2070                  | 2150   | 2230   | 2310                             | 2390                      | 1670   | 1750     | 1830      |
| 170 DOUBLE RECLINING CHAIR RIGHT ARM   | 42x40x33/40   | 1990    | 2070                  | 2150   | 2230   | 2310                             | 2390                      | 1670   | 1750     | 1830      |
| 171 ARMLESS DOUBLE RECLINING CHAIR     | 30,5x40x33/40 | 1575    | 1625                  | 1675   | 1725   | 1775                             | 1825                      | 1320   | 1380     | 1440      |

## SAN FRANCISCO

**FEATURES:**

- Manual adjustable headrest on all items (2 on square corner & stationary on wedge).
- \*Wall hugger power recliners with full footrest (manual n/a).
- Power recliner lounge chair (manual n/a) with power headrest in option. Wall clearance 8" & front 5".
- Seat cushions with shaped foam + 1" layer of memory foam on top.
- Stitching: Small thread in fabric & large flat thread in leather.
- \*Excludes chairs 043 & 163: Wall clearance 16"

Note: 2 recliner seats separated by a corner can not be opened at the same time. No recliner seats beside #155 Small Square Corner.

**OPTIONS**

- Battery Pack: Add \$160/ea.
- \*Motorized headrest: Add \$160 ea. (\*N/A on stationary items).
- Foam: Extra firm add \$15/seat.
- Choice of Large or Small 6" Arm: Leg on LARGE arm: LG08 wood or LG64 metal. SMALL 6" arm: LG195 wood, metal leg N/A. Specify wood colour.
- Seat Depth: 20" or \*22". \*22" seat depth N/A on chairs 043 & 163.
- 043 & 163 Chairs: with wood base (specify colour).

| Description                            | L x D x H     | Leather |                       |  |  |                                  |                           | Fabric |          |           |
|--|---------------|---------|-----------------------|--|--|----------------------------------|---------------------------|--------|----------|-----------|
|  |               | 10      | 20<br>Madras<br>Softy | 30<br>Hugo<br>Fantasy<br>Illusion<br>Tucson<br>Utah<br>Vintage<br>Wild Laredo<br>Yukon | 40<br>Elegance<br>Princess<br>Santiago<br>Sensation<br>Sunset<br>Trina<br>Victoria | 50<br>Bull<br>Cassiope<br>Dublin | 60<br>Caress<br>Ultrasued | A      | B<br>COM | C<br>alta |
| 173 DOUBLE LOUNGE CHAIR LEFT ARM       | 42x62x33/40   | 1915    | 2005                  | 2095   | 2185   | 2275                             | 2365                      | 1535   | 1615     | 1695      |
| 174 DOUBLE LOUNGE CHAIR RIGHT ARM      | 42x62x33/40   | 1915    | 2005                  | 2095   | 2185   | 2275                             | 2365                      | 1535   | 1615     | 1695      |
| 175 DOUBLE CHAIR LEFT ARM              | 42x40x33/40   | 1590    | 1680                  | 1770   | 1860   | 1950                             | 2040                      | 1285   | 1350     | 1415      |
| 176 DOUBLE CHAIR RIGHT ARM             | 42x40x33/40   | 1590    | 1680                  | 1770   | 1860   | 1950                             | 2040                      | 1285   | 1350     | 1415      |
| 177 ARMLESS DOUBLE CHAIR               | 30,5x40x33/40 | 1185    | 1250                  | 1315   | 1380   | 1445                             | 1510                      | 915    | 970      | 1025      |
| 178 ARMLESS DOUBLE CHAIR BUMPER LEFT   | 52x40x33/40   | 1545    | 1625                  | 1705   | 1785   | 1865                             | 1945                      | 1230   | 1290     | 1350      |
| 179 ARMLESS DOUBLE CHAIR BUMPER RIGHT  | 52x40x33/40   | 1545    | 1625                  | 1705   | 1785   | 1865                             | 1945                      | 1230   | 1290     | 1350      |
| 186 ARMLESS LOVESEAT BUMPER STORAGE-L  | 68x40x33/40   | 2420    | 2500                  | 2580   | 2660   | 2740                             | 2820                      | 1950   | 2015     | 2080      |
| 187 ARMLESS LOVESEAT BUMPER STORAGE-R  | 68x40x33/40   | 2420    | 2500                  | 2580   | 2660   | 2740                             | 2820                      | 1950   | 2015     | 2080      |
| 188 ARMLESS CHAIR BUMPER STORAGE-L     | 45x40x33/40   | 1600    | 1690                  | 1780   | 1870   | 1960                             | 2050                      | 1295   | 1330     | 1365      |
| 189 ARMLESS CHAIR BUMPER STORAGE-R     | 45x40x33/40   | 1600    | 1690                  | 1780   | 1870   | 1960                             | 2050                      | 1295   | 1330     | 1365      |
| 221 ARMLESS DBL CHAIR BUMPER STORAGE-L | 52x40x33/40   | 1705    | 1790                  | 1875   | 1960   | 2045                             | 2130                      | 1390   | 1450     | 1510      |
| 222 ARMLESS DBL CHAIR BUMPER STORAGE-R | 52x40x33/40   | 1705    | 1790                  | 1875   | 1960   | 2045                             | 2130                      | 1390   | 1450     | 1510      |
| 223 APT SOFA NO ARM BUMPER STORAGE-L   | 82x40x33/40   | 2655    | 2785                  | 2915   | 3045   | 3175                             | 3305                      | 2120   | 2215     | 2310      |
| 224 APT SOFA NO ARM BUMPER STORAGE-R   | 82x40x33/40   | 2655    | 2785                  | 2915   | 3045   | 3175                             | 3305                      | 2120   | 2215     | 2310      |
| 236 RECLINING LOUNGE CHAIR LEFT ARM    | 35x62x33/40   | 2160    | 2225                  | 2290   | 2355   | 2420                             | 2485                      | 1820   | 1880     | 1940      |
| 237 RECLINING LOUNGE CHAIR RIGHT ARM   | 35x62x33/40   | 2160    | 2225                  | 2290   | 2355   | 2420                             | 2485                      | 1820   | 1880     | 1940      |
| 238 RECLINING DBL LOUNGE CHAIR L-ARM   | 42x62x33/40   | 2315    | 2405                  | 2495   | 2585   | 2675                             | 2765                      | 1940   | 2020     | 2100      |
| 239 RECLINING DBL LOUNGE CHAIR R-ARM   | 42x62x33/40   | 2315    | 2405                  | 2495   | 2585   | 2675                             | 2765                      | 1940   | 2020     | 2100      |
| <b>CONFIGURATIONS</b>                  |               |         |                       |  |  |                                  |                           |        |          |           |

## CDN Price List

### SAN FRANCISCO

| Description                | L x D x H  | Leather |                       |  |  |                                  |                           | Fabric |          |           |
|----------------------------|------------|---------|-----------------------|--|--|----------------------------------|---------------------------|--------|----------|-----------|
|                            |            | 10      | 20<br>Madras<br>Softy | 30<br>Hugo<br>Fantasy<br>Illusion<br>Tucson<br>Utah<br>Vintage<br>Wild Laredo<br>Yukon | 40<br>Elegance<br>Princess<br>Santiago<br>Sensation<br>Sunset<br>Trina<br>Victoria | 50<br>Bull<br>Cassiope<br>Dublin | 60<br>Caress<br>Ultrasued | A      | B<br>COM | C<br>alta |
| A CONFIG (169-170)         | 84X40X40   | 3980    | 4140                  | 4300   | 4460   | 4620                             | 4780                      | 3340   | 3500     | 3660      |
| B CONFIG (169-171-174)     | 115X62X40  | 5480    | 5700                  | 5920   | 6140   | 6360                             | 6580                      | 4525   | 4745     | 4965      |
| C CONFIG (096-055-171-170) | 116X116X40 | 8050    | 8385                  | 8720   | 9055   | 9390                             | 9725                      | 6520   | 6805     | 7090      |
| D CONFIG (169-171-055-179) | 116X96X40  | 7025    | 7330                  | 7635   | 7940   | 8245                             | 8550                      | 5730   | 5985     | 6240      |
| J CONFIG (041-042)         | 70X40X40   | 3770    | 3920                  | 4070   | 4220   | 4370                             | 4520                      | 3210   | 3280     | 3350      |
| K CONFIG (041-071-005)     | 94X62X40   | 5120    | 5315                  | 5510   | 5705   | 5900                             | 6095                      | 4265   | 4420     | 4575      |
| L CONFIG (012-055-071-042) | 102X102X40 | 7590    | 7915                  | 8240   | 8565   | 8890                             | 9215                      | 6215   | 6440     | 6665      |
| M CONFIG (041-071-055-089) | 103X89X40  | 6710    | 7030                  | 7350   | 7670   | 7990                             | 8310                      | 5495   | 5680     | 5865      |



# SAN FRANCISCO

**OPTIMA**  
Collection

**Jaymar**

Conçu et fabriqué fièrement au Canada  
Proudly designed and made in Canada

Nos produits sont fabriqués à la main et des variations mineures peuvent survenir

Our product is hand-made and minor variations can occur.

## SPECIFICATIONS

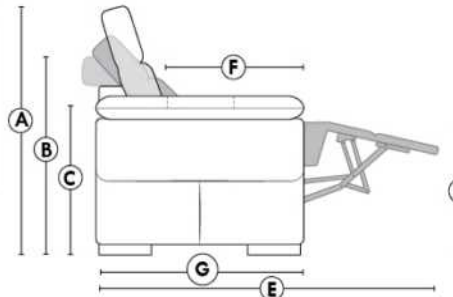

- Appui-tête levé / Headrest up
- Appui-tête baissé / Headrest down
- Complètement incliné / Fully reclined

- A** Hauteur complète 40" Total Height
- B** Hauteur appui-tête baissé 33" Height headrest down
- C** Hauteur du bras 25" Arm Height
- D** Hauteur du siège 19,5" Seat height
- E** Profondeur inclinée 65" Depth fully reclined
- F** Profondeur d'assise 20" ou/ou 22" Seat depth
- G** Profondeur appui-tête monté 37,5" Depth with headrest up

## BRAS | ARMS

Option de bras:  
Bras Régulier Large 10,5" ou Petit bras 6"

Arm option  
Regular arm Large 10.5" or Small arm 6"

Contrôle de l'inclinaison situé à l'extérieur du bras  
Recliner control located on the outside of the arm.

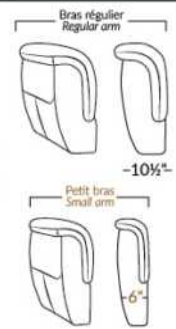

## FAUTEUIL BERÇANT PIVOTANT INCLINABLE SWIVEL ROCKING MOTION CHAIR

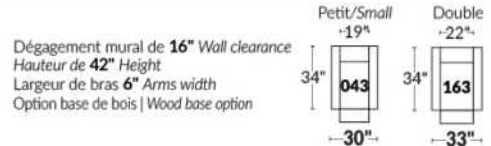

## SIÈGE 23" DE LARGE | 23" SEAT WIDTH

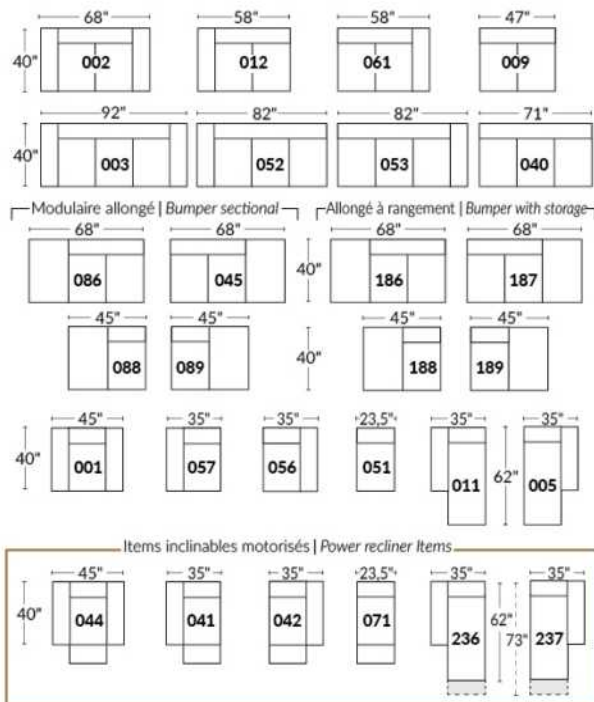

## SIÈGE 30" DE LARGE | 30" SEAT WIDTH

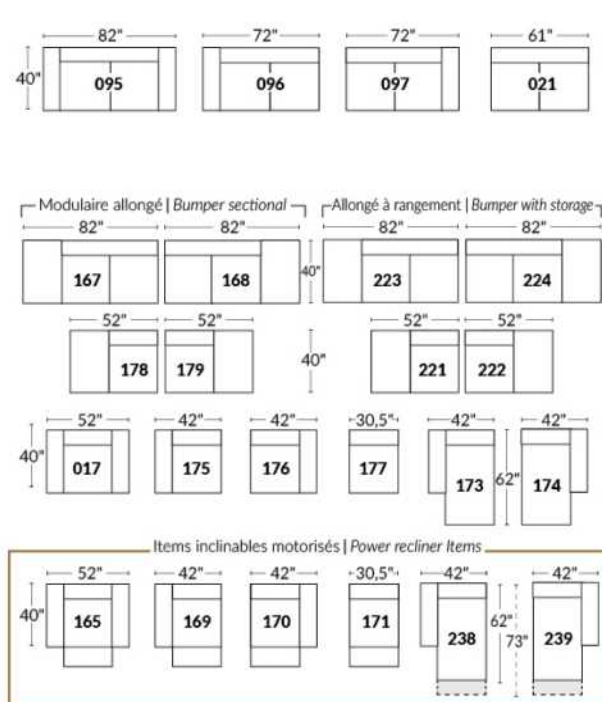

### Autres | Others

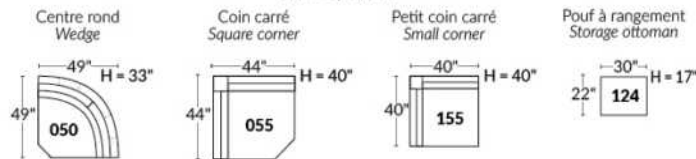

## EXEMPLE 23" EXAMPLE

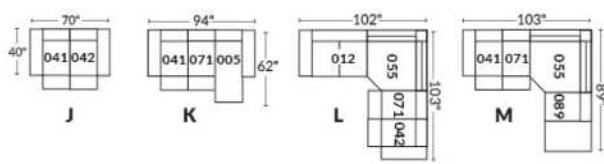

## EXEMPLE 30" EXAMPLE

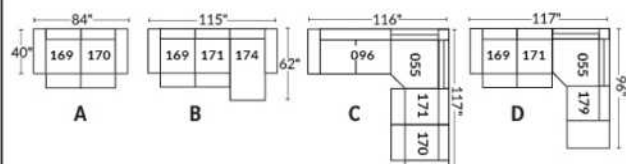

## CDN Price List

### SCORPIO

COMBO: Cover #2 on seat cushions only.  
 FABRIC: There is no stitching on back and seat cushions.  
 LEG: LG82 metal.  
 COMBO:  
 Cover #1: Arms, outside and inside back.  
 Cover #2: Top and front of seat cushion.  
 1x PL.12 for Apt. Sofa and 1x PL.12 for Loveseat.

| Description        | L x D x H | Leather |                       |  |  |                                  |                           | Fabric |          |           |
|--------------------|-----------|---------|-----------------------|--|--|----------------------------------|---------------------------|--------|----------|-----------|
|                    |           | 10      | 20<br>Madras<br>Softy | 30<br>Hugo<br>Fantasy<br>Illusion<br>Tucson<br>Utah<br>Vintage<br>Wild Laredo<br>Yukon | 40<br>Elegance<br>Princess<br>Santiago<br>Sensation<br>Sunset<br>Trina<br>Victoria | 50<br>Bull<br>Cassiope<br>Dublin | 60<br>Caress<br>Ultrasued | A      | B<br>COM | C<br>alta |
| 001 CHAIR          | 47X38X32  | 1545    | 1630                  | 1715   | 1800   | 1885                             | 1970                      | 1085   | 1135     | 1185      |
| 002 LOVESEAT       | 73X38X34  | 2160    | 2295                  | 2430   | 2565   | 2700                             | 2835                      | 1575   | 1650     | 1725      |
| 006 OTTOMAN        | 25X25X18  | 715     | 740                   | 765  | 790  | 815                              | 840                       | 600    | 610      | 620       |
| 095 APARTMENT SOFA | 88X38X34  | 2280    | 2410                  | 2540   | 2670   | 2800                             | 2930                      | 1655   | 1730     | 1805      |



# SCORPIO



Hauteur de siège 18" | Hauteur devant bras 34" | Profondeur d'assise 21"  
Seat Height 18" | Arm Height 34" | Seat Depth 21"

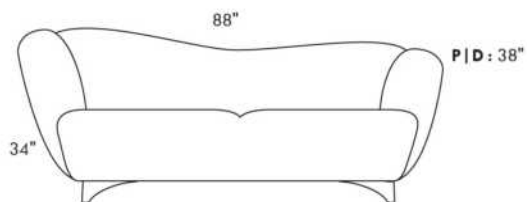

095\*

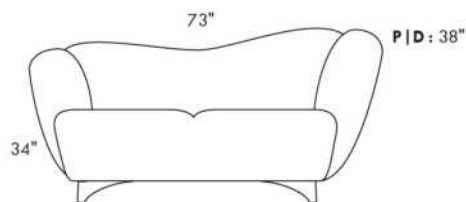

002\*

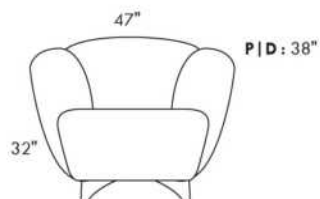

001

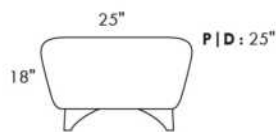

006

\*COUSSIN DÉCORATIF INCLU\*  
\*ARM BOLSTER INCLUDED\*

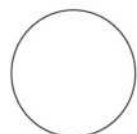

PL12

Diam.: 17"  
rond | round

## SEATTLE

### FEATURES:

- Manual adjustable headrest on all items (stationary on wedge).
- \*Wall hugger power recliners with full footrest (manual n/a).
- Power recliner lounge chair (manual n/a) with power headrest in option. Wall clearance 8" & front 5".
- Seat cushions with shaped foam + 1" layer of memory foam on top; arm with memory foam.
- Stitching: Small thread in fabric & large flat thread in leather.
- \*Excludes 043 & 163 chairs: Wall clearance 16"

Note: 2 recliner seats separated by a corner can not be opened at the same time. No recliner seats beside #155 Small Square Corner.

### OPTIONS

- Battery Pack: Add \$160/ea.
- \*Motorized headrest: Add \$160 ea. (\*N/A on stationary items).
- Foam: Extra firm add \$15/seat.
- Choice of Large or Small 6" Arm: Leg on LARGE arm: LG187 wood or Metal: LG189 cyl. (Black or Chrome) or LG64 (sq). SMALL Arm: LG08 wood or Metal: LG196 cyl. (Black or Chrome) or LG64 (sq). Specify colour.
- Seat Depth: 20" or \*22". \*22" seat depth N/A on chairs 043 & 163.
- 043 & 163 Chairs: with wood base (specify colour).

### HOME THEATRE Configurations

For Accessories, Cup holders & Configuration details, see Optima Home Theatre page attached.

Accessory Dock : \$35 ea.

Cup Holders: Metal: \$25 ea. | LED lighted Cup Holder: \$25 ea. | \*LED lighted Cup Holder with (1 or 2 motor) controls: \$40 ea.

\*LED Light strip under seat: \$25/seat.

| Description                        | L x D x H   | Leather |                       |  |  |                                  |                           | Fabric |          |           |
|------------------------------------|-------------|---------|-----------------------|--|--|----------------------------------|---------------------------|--------|----------|-----------|
|                                    |             | 10      | 20<br>Madras<br>Softy | 30<br>Hugo<br>Fantasy<br>Illusion<br>Tucson<br>Utah<br>Vintage<br>Wild Laredo<br>Yukon | 40<br>Elegance<br>Princess<br>Santiago<br>Sensation<br>Sunset<br>Trina<br>Victoria | 50<br>Bull<br>Cassiope<br>Dublin | 60<br>Caress<br>Ultrasued | A      | B<br>COM | C<br>alta |
| 001 CHAIR                          | 42x40x33/40 | 1890    | 1980                  | 2070   | 2160   | 2250                             | 2340                      | 1535   | 1580     | 1625      |
| 002 LOVESEAT                       | 65x40x33/40 | 2700    | 2815                  | 2930   | 3045   | 3160                             | 3275                      | 2175   | 2250     | 2325      |
| 003 SOFA                           | 89x40x33/40 | 3265    | 3415                  | 3565   | 3715   | 3865                             | 4015                      | 2625   | 2715     | 2805      |
| 005 LOUNGE CHAIR RIGHT ARM         | 33x62x33/40 | 1765    | 1830                  | 1895   | 1960   | 2025                             | 2090                      | 1410   | 1470     | 1530      |
| 009 ARMLESS LOVESEAT               | 47x40x33/40 | 1895    | 1965                  | 2035   | 2105   | 2175                             | 2245                      | 1490   | 1570     | 1650      |
| 011 LOUNGE CHAIR LEFT ARM          | 33x62x33/40 | 1765    | 1830                  | 1895   | 1960   | 2025                             | 2090                      | 1410   | 1470     | 1530      |
| 012 LOVESEAT LEFT ARM              | 56x40x33/40 | 2320    | 2420                  | 2520   | 2620   | 2720                             | 2820                      | 1850   | 1925     | 2000      |
| 017 DOUBLE CHAIR                   | 49x40x33/40 | 1980    | 2080                  | 2180   | 2280   | 2380                             | 2480                      | 1600   | 1660     | 1720      |
| 021 APARTMENT SOFA NO ARM          | 61x40x33/40 | 2140    | 2240                  | 2340   | 2440   | 2540                             | 2640                      | 1670   | 1755     | 1840      |
| 040 ARMLESS SOFA                   | 71x40x33/40 | 2450    | 2565                  | 2680   | 2795   | 2910                             | 3025                      | 1950   | 2040     | 2130      |
| 041 RECLINING CHAIR LEFT ARM       | 33x40x33/40 | 1885    | 1960                  | 2035   | 2110   | 2185                             | 2260                      | 1605   | 1640     | 1675      |
| 042 RECLINING CHAIR RIGHT ARM      | 33x40x33/40 | 1885    | 1960                  | 2035   | 2110   | 2185                             | 2260                      | 1605   | 1640     | 1675      |
| 043 SWIVEL ROCKING RECLINING CHAIR | 30x34x42    | 2235    | 2345                  | 2455   | 2565   | 2675                             | 2785                      | 1875   | 1920     | 1965      |
| 044 RECLINER CHAIR                 | 42x40x33/40 | 2275    | 2365                  | 2455   | 2545   | 2635                             | 2725                      | 1920   | 1970     | 2020      |
| 045 ARMLESS LOVESEAT BUMPER RIGHT  | 68x40x33/40 | 2245    | 2340                  | 2435   | 2530   | 2625                             | 2720                      | 1785   | 1850     | 1915      |
| 050 WEDGE                          | 49x49x33    | 1645    | 1745                  | 1845   | 1945   | 2045                             | 2145                      | 1210   | 1270     | 1330      |

## SEATTLE

**FEATURES:**

- Manual adjustable headrest on all items (stationary on wedge).
- \*Wall hugger power recliners with full footrest (manual n/a).
- Power recliner lounge chair (manual n/a) with power headrest in option. Wall clearance 8" & front 5".
- Seat cushions with shaped foam + 1" layer of memory foam on top; arm with memory foam.
- Stitching: Small thread in fabric & large flat thread in leather.
- \*Excludes 043 & 163 chairs: Wall clearance 16"

Note: 2 recliner seats separated by a corner can not be opened at the same time. No recliner seats beside #155 Small Square Corner.

**OPTIONS**

- Battery Pack: Add \$160/ea.
- \*Motorized headrest: Add \$160 ea. (\*N/A on stationary items).
- Foam: Extra firm add \$15/seat.
- Choice of Large or Small 6" Arm: Leg on LARGE arm: LG187 wood or Metal: LG189 cyl. (Black or Chrome) or LG64 (sq). SMALL Arm: LG08 wood or Metal: LG196 cyl. (Black or Chrome) or LG64 (sq). Specify colour.
- Seat Depth: 20" or \*22". \*22" seat depth N/A on chairs 043 & 163.
- 043 & 163 Chairs: with wood base (specify colour).

**HOME THEATRE Configurations**

For Accessories, Cup holders & Configuration details, see Optima Home Theatre page attached.

Accessory Dock : \$35 ea.

Cup Holders: Metal: \$25 ea. | LED lighted Cup Holder: \$25 ea. | \*LED lighted Cup Holder with (1 or 2 motor) controls: \$40 ea.

\*LED Light strip under seat: \$25/seat.

| Description                      | L x D x H     | Leather |                       |  |  |                                  |                            | Fabric |          |           |
|----------------------------------|---------------|---------|-----------------------|--|--|----------------------------------|----------------------------|--------|----------|-----------|
|                                  |               | 10      | 20<br>Madras<br>Softy | 30<br>Hugo<br>Fantasy<br>Illusion<br>Tucson<br>Utah<br>Vintage<br>Wild Laredo<br>Yukon | 40<br>Elegance<br>Princess<br>Santiago<br>Sensation<br>Sunset<br>Trina<br>Victoria | 50<br>Bull<br>Cassiope<br>Dublin | 60<br>Caresse<br>Ultrasued | A      | B<br>COM | C<br>alta |
| 051 ARMLESS CHAIR                | 23,5x40x33/40 | 1085    | 1135                  | 1185   | 1235   | 1285                             | 1335                       | 845    | 900      | 955       |
| 052 SOFA LEFT ARM                | 80x40x33/40   | 2870    | 3005                  | 3140   | 3275   | 3410                             | 3545                       | 2290   | 2385     | 2480      |
| 053 SOFA RIGHT ARM               | 80x40x33/40   | 2870    | 3005                  | 3140   | 3275   | 3410                             | 3545                       | 2290   | 2385     | 2480      |
| 055 SQUARE CORNER                | 44x44x33/40   | 1915    | 2010                  | 2105   | 2200   | 2295                             | 2390                       | 1510   | 1565     | 1620      |
| 056 CHAIR RIGHT ARM              | 33x40x33/40   | 1510    | 1575                  | 1640   | 1705   | 1770                             | 1835                       | 1200   | 1260     | 1320      |
| 057 CHAIR LEFT ARM               | 33x40x33/40   | 1510    | 1575                  | 1640   | 1705   | 1770                             | 1835                       | 1200   | 1260     | 1320      |
| 061 LOVESEAT RIGHT ARM           | 56x40x33/40   | 2320    | 2420                  | 2520   | 2620   | 2720                             | 2820                       | 1850   | 1925     | 2000      |
| 071 ARMLESS RECLINING CHAIR      | 23,5x40x33/40 | 1470    | 1525                  | 1580   | 1635   | 1690                             | 1745                       | 1250   | 1310     | 1370      |
| 086 ARMLESS LOVESEAT BUMPER LEFT | 68x40x33/40   | 2245    | 2340                  | 2435   | 2530   | 2625                             | 2720                       | 1785   | 1850     | 1915      |
| 088 ARMLESS CHAIR BUMPER LEFT    | 45x40x33/40   | 1440    | 1535                  | 1630   | 1725   | 1820                             | 1915                       | 1130   | 1165     | 1200      |
| 089 ARMLESS CHAIR BUMPER RIGHT   | 45x40x33/40   | 1440    | 1535                  | 1630   | 1725   | 1820                             | 1915                       | 1130   | 1165     | 1200      |
| 095 APARTMENT SOFA               | 79x40x33/40   | 2940    | 3085                  | 3230   | 3375   | 3520                             | 3665                       | 2350   | 2445     | 2540      |
| 096 APARTMENT SOFA LEFT ARM      | 70x40x33/40   | 2570    | 2680                  | 2790   | 2900   | 3010                             | 3120                       | 2020   | 2110     | 2200      |
| 097 APARTMENT SOFA RIGHT ARM     | 70x40x33/40   | 2570    | 2680                  | 2790   | 2900   | 3010                             | 3120                       | 2020   | 2110     | 2200      |
| 124 STORAGE OTTOMAN              | 30x22x17      | 745     | 765                   | 785  | 805  | 825                              | 845                        | 650    | 670      | 690       |
| 138 STRAIGHT ARM                 | 9x36x24       | 415     | 450                   | 485  | 520  | 555                              | 590                        | 350    | 365      | 380       |

## SEATTLE

### FEATURES:

- Manual adjustable headrest on all items (stationary on wedge).
- \*Wall hugger power recliners with full footrest (manual n/a).
- Power recliner lounge chair (manual n/a) with power headrest in option. Wall clearance 8" & front 5".
- Seat cushions with shaped foam + 1" layer of memory foam on top; arm with memory foam.
- Stitching: Small thread in fabric & large flat thread in leather.
- \*Excludes 043 & 163 chairs: Wall clearance 16"

Note: 2 recliner seats separated by a corner can not be opened at the same time. No recliner seats beside #155 Small Square Corner.

### OPTIONS

- Battery Pack: Add \$160/ea.
- \*Motorized headrest: Add \$160 ea. (\*N/A on stationary items).
- Foam: Extra firm add \$15/seat.
- Choice of Large or Small 6" Arm: Leg on LARGE arm: LG187 wood or Metal: LG189 cyl. (Black or Chrome) or LG64 (sq). SMALL Arm: LG08 wood or Metal: LG196 cyl. (Black or Chrome) or LG64 (sq). Specify colour.
- Seat Depth: 20" or \*22". \*22" seat depth N/A on chairs 043 & 163.
- 043 & 163 Chairs: with wood base (specify colour).

### HOME THEATRE Configurations

For Accessories, Cup holders & Configuration details, see Optima Home Theatre page attached.

Accessory Dock : \$35 ea.

Cup Holders: Metal: \$25 ea. | LED lighted Cup Holder: \$25 ea. | \*LED lighted Cup Holder with (1 or 2 motor) controls: \$40 ea.

\*LED Light strip under seat: \$25/seat.

| Description                            | L x D x H     | Leather |                       |  |  |                                  |                           | Fabric |          |           |
|--|---------------|---------|-----------------------|--|--|----------------------------------|---------------------------|--------|----------|-----------|
|  |               | 10      | 20<br>Madras<br>Softy | 30<br>Hugo<br>Fantasy<br>Illusion<br>Tucson<br>Utah<br>Vintage<br>Wild Laredo<br>Yukon | 40<br>Elegance<br>Princess<br>Santiago<br>Sensation<br>Sunset<br>Trina<br>Victoria | 50<br>Bull<br>Cassiope<br>Dublin | 60<br>Caress<br>Ultrasued | A      | B<br>COM | C<br>alta |
| 155 SMALL SQUARE CORNER                | 40x40x33/40   | 1915    | 2010                  | 2105   | 2200   | 2295                             | 2390                      | 1510   | 1565     | 1620      |
| 159 WEDGE STORAGE                      | 12/27x36x24   | 745     | 775                   | 805  | 835  | 865                              | 895                       | 585    | 600      | 615       |
| 160 STRAIGHT STORAGE                   | 12x36x24      | 720     | 745                   | 770  | 795  | 820                              | 845                       | 550    | 570      | 590       |
| 163 DBL SWIVEL ROCKING RECLINER CHAIR  | 33x34x42      | 2290    | 2410                  | 2530   | 2650   | 2770                             | 2890                      | 1880   | 1930     | 1980      |
| 165 DOUBLE RECLINING CHAIR             | 49x40x33/40   | 2375    | 2475                  | 2575   | 2675   | 2775                             | 2875                      | 2000   | 2065     | 2130      |
| 167 APARTMENT SOFA NO ARM BUMPER LEFT  | 82x40x33/40   | 2490    | 2620                  | 2750   | 2880   | 3010                             | 3140                      | 1960   | 2045     | 2130      |
| 168 APARTMENT SOFA NO ARM BUMPER RIGHT | 82x40x33/40   | 2490    | 2620                  | 2750   | 2880   | 3010                             | 3140                      | 1960   | 2045     | 2130      |
| 169 DOUBLE RECLINING CHAIR LEFT ARM    | 40x40x33/40   | 1990    | 2070                  | 2150   | 2230   | 2310                             | 2390                      | 1670   | 1750     | 1830      |
| 170 DOUBLE RECLINING CHAIR RIGHT ARM   | 40x40x33/40   | 1990    | 2070                  | 2150   | 2230   | 2310                             | 2390                      | 1670   | 1750     | 1830      |
| 171 ARMLESS DOUBLE RECLINING CHAIR     | 30,5x40x33/40 | 1575    | 1625                  | 1675   | 1725   | 1775                             | 1825                      | 1320   | 1380     | 1440      |
| 173 DOUBLE LOUNGE CHAIR LEFT ARM       | 40x62x33/40   | 1915    | 2005                  | 2095   | 2185   | 2275                             | 2365                      | 1535   | 1615     | 1695      |
| 174 DOUBLE LOUNGE CHAIR RIGHT ARM      | 40x62x33/40   | 1915    | 2005                  | 2095   | 2185   | 2275                             | 2365                      | 1535   | 1615     | 1695      |
| 175 DOUBLE CHAIR LEFT ARM              | 40x40x33/40   | 1590    | 1680                  | 1770   | 1860   | 1950                             | 2040                      | 1285   | 1350     | 1415      |
| 176 DOUBLE CHAIR RIGHT ARM             | 40x40x33/40   | 1590    | 1680                  | 1770   | 1860   | 1950                             | 2040                      | 1285   | 1350     | 1415      |
| 177 ARMLESS DOUBLE CHAIR               | 30,5x40x33/40 | 1185    | 1250                  | 1315   | 1380   | 1445                             | 1510                      | 915    | 970      | 1025      |
| 178 ARMLESS DOUBLE CHAIR BUMPER LEFT   | 52x40x33/40   | 1545    | 1625                  | 1705   | 1785   | 1865                             | 1945                      | 1230   | 1290     | 1350      |

## SEATTLE

### FEATURES:

- Manual adjustable headrest on all items (stationary on wedge).
- \*Wall hugger power recliners with full footrest (manual n/a).
- Power recliner lounge chair (manual n/a) with power headrest in option. Wall clearance 8" & front 5".
- Seat cushions with shaped foam + 1" layer of memory foam on top; arm with memory foam.
- Stitching: Small thread in fabric & large flat thread in leather.
- \*Excludes 043 & 163 chairs: Wall clearance 16"

Note: 2 recliner seats separated by a corner can not be opened at the same time. No recliner seats beside #155 Small Square Corner.

### OPTIONS

- Battery Pack: Add \$160/ea.
- \*Motorized headrest: Add \$160 ea. (\*N/A on stationary items).
- Foam: Extra firm add \$15/seat.
- Choice of Large or Small 6" Arm: Leg on LARGE arm: LG187 wood or Metal: LG189 cyl. (Black or Chrome) or LG64 (sq). SMALL Arm: LG08 wood or Metal: LG196 cyl. (Black or Chrome) or LG64 (sq). Specify colour.
- Seat Depth: 20" or \*22". \*22" seat depth N/A on chairs 043 & 163.
- 043 & 163 Chairs: with wood base (specify colour).

### HOME THEATRE Configurations

For Accessories, Cup holders & Configuration details, see Optima Home Theatre page attached.

Accessory Dock : \$35 ea.

Cup Holders: Metal: \$25 ea. | LED lighted Cup Holder: \$25 ea. | \*LED lighted Cup Holder with (1 or 2 motor) controls: \$40 ea.

\*LED Light strip under seat: \$25/seat.

| Description                            | L x D x H       | Leather |                       |  |  |                                  |                           | Fabric |          |           |
|--|-----------------|---------|-----------------------|--|--|----------------------------------|---------------------------|--------|----------|-----------|
|  |                 | 10      | 20<br>Madras<br>Softy | 30<br>Hugo<br>Fantasy<br>Illusion<br>Tucson<br>Utah<br>Vintage<br>Wild Laredo<br>Yukon | 40<br>Elegance<br>Princess<br>Santiago<br>Sensation<br>Sunset<br>Trina<br>Victoria | 50<br>Bull<br>Cassiope<br>Dublin | 60<br>Caress<br>Ultrasued | A      | B<br>COM | C<br>alta |
| 179 ARMLESS DOUBLE CHAIR BUMPER RIGHT  | 52x40x33/40     | 1545    | 1625                  | 1705   | 1785   | 1865                             | 1945                      | 1230   | 1290     | 1350      |
| 186 ARMLESS LOVESEAT BUMPER STORAGE-L  | 68x40x33/40     | 2420    | 2500                  | 2580   | 2660   | 2740                             | 2820                      | 1950   | 2015     | 2080      |
| 187 ARMLESS LOVESEAT BUMPER STORAGE-R  | 68x40x33/40     | 2420    | 2500                  | 2580   | 2660   | 2740                             | 2820                      | 1950   | 2015     | 2080      |
| 188 ARMLESS CHAIR BUMPER STORAGE-L     | 45x40x33/40     | 1600    | 1690                  | 1780   | 1870   | 1960                             | 2050                      | 1295   | 1330     | 1365      |
| 189 ARMLESS CHAIR BUMPER STORAGE-R     | 45x40x33/40     | 1600    | 1690                  | 1780   | 1870   | 1960                             | 2050                      | 1295   | 1330     | 1365      |
| 190 SMALL WEDGE STORAGE                | 12/21x36x24     | 720     | 745                   | 770  | 795  | 820                              | 845                       | 550    | 570      | 590       |
| 221 ARMLESS DBL CHAIR BUMPER STORAGE-L | 52x40x33/40     | 1705    | 1790                  | 1875   | 1960   | 2045                             | 2130                      | 1390   | 1450     | 1510      |
| 222 ARMLESS DBL CHAIR BUMPER STORAGE-R | 52x40x33/40     | 1705    | 1790                  | 1875   | 1960   | 2045                             | 2130                      | 1390   | 1450     | 1510      |
| 223 APT SOFA NO ARM BUMPER STORAGE-L   | 82x40x33/40     | 2655    | 2785                  | 2915   | 3045   | 3175                             | 3305                      | 2120   | 2215     | 2310      |
| 224 APT SOFA NO ARM BUMPER STORAGE-R   | 82x40x33/40     | 2655    | 2785                  | 2915   | 3045   | 3175                             | 3305                      | 2120   | 2215     | 2310      |
| 236 RECLINING LOUNGE CHAIR LEFT ARM    | 33x62x33/40     | 2160    | 2225                  | 2290   | 2355   | 2420                             | 2485                      | 1820   | 1880     | 1940      |
| 237 RECLINING LOUNGE CHAIR RIGHT ARM   | 33x62x33/40     | 2160    | 2225                  | 2290   | 2355   | 2420                             | 2485                      | 1820   | 1880     | 1940      |
| 238 RECLINING DBL LOUNGE CHAIR L-ARM   | 40x62x33/40     | 2315    | 2405                  | 2495   | 2585   | 2675                             | 2765                      | 1940   | 2020     | 2100      |
| 239 RECLINING DBL LOUNGE CHAIR R-ARM   | 40x62x33/40     | 2315    | 2405                  | 2495   | 2585   | 2675                             | 2765                      | 1940   | 2020     | 2100      |
| V51 WINE GLASS HOLDER                  | 3.5 x 5.5 x 6.5 | 35      | 35                    | 35   | 35   | 35                               | 35                        | 35     | 35       | 35        |
| V52 PLASTIC SWIVEL TRAY                | 13 3/8 x 9 5/8  | 35      | 35                    | 35   | 35   | 35                               | 35                        | 35     | 35       | 35        |

## SEATTLE

### FEATURES:

- Manual adjustable headrest on all items (stationary on wedge).
- \*Wall hugger power recliners with full footrest (manual n/a).
- Power recliner lounge chair (manual n/a) with power headrest in option. Wall clearance 8" & front 5".
- Seat cushions with shaped foam + 1" layer of memory foam on top; arm with memory foam.
- Stitching: Small thread in fabric & large flat thread in leather.
- \*Excludes 043 & 163 chairs: Wall clearance 16"

Note: 2 recliner seats separated by a corner can not be opened at the same time. No recliner seats beside #155 Small Square Corner.

### OPTIONS

- Battery Pack: Add \$160/ea.
- \*Motorized headrest: Add \$160 ea. (\*N/A on stationary items).
- Foam: Extra firm add \$15/seat.
- Choice of Large or Small 6" Arm: Leg on LARGE arm: LG187 wood or Metal: LG189 cyl. (Black or Chrome) or LG64 (sq). SMALL Arm: LG08 wood or Metal: LG196 cyl. (Black or Chrome) or LG64 (sq). Specify colour.
- Seat Depth: 20" or \*22". \*22" seat depth N/A on chairs 043 & 163.
- 043 & 163 Chairs: with wood base (specify colour).

### HOME THEATRE Configurations

For Accessories, Cup holders & Configuration details, see Optima Home Theatre page attached.

Accessory Dock : \$35 ea.

Cup Holders: Metal: \$25 ea. | LED lighted Cup Holder: \$25 ea. | \*LED lighted Cup Holder with (1 or 2 motor) controls: \$40 ea.

\*LED Light strip under seat: \$25/seat.

| Description                 | L x D x H          | Leather |                       |  |  |                                  |                           | Fabric |          |           |
|-----------------------------|--------------------|---------|-----------------------|--|--|----------------------------------|---------------------------|--------|----------|-----------|
|                             |                    | 10      | 20<br>Madras<br>Softy | 30<br>Hugo<br>Fantasy<br>Illusion<br>Tucson<br>Utah<br>Vintage<br>Wild Laredo<br>Yukon | 40<br>Elegance<br>Princess<br>Santiago<br>Sensation<br>Sunset<br>Trina<br>Victoria | 50<br>Bull<br>Cassiope<br>Dublin | 60<br>Caress<br>Ultrasued | A      | B<br>COM | C<br>alta |
| V53 WOOD SWIVEL TRAY        | 19 x 10            | 60      | 60                    | 60   | 60   | 60                               | 60                        | 60     | 60       | 60        |
| V54 TABLET HOLDER           | 4.5 x 8 x 10       | 40      | 40                    | 40   | 40   | 40                               | 40                        | 40     | 40       | 40        |
| V55 LED LAMP                | 1.5x5x14 plié/bent | 35      | 35                    | 35   | 35   | 35                               | 35                        | 35     | 35       | 35        |
| <b>CONFIGURATIONS</b>       |                    |         |                       |  |  |                                  |                           |        |          |           |
| _A CONFIG (169-170)         | 80X40X40           | 3980    | 4140                  | 4300   | 4460   | 4620                             | 4780                      | 3340   | 3500     | 3660      |
| _B CONFIG (169-171-174)     | 111X62X40          | 5480    | 5700                  | 5920   | 6140   | 6360                             | 6580                      | 4525   | 4745     | 4965      |
| _C CONFIG (096-055-171-170) | 115X115X40         | 8050    | 8385                  | 8720   | 9055   | 9390                             | 9725                      | 6520   | 6805     | 7090      |
| _D CONFIG (169-171-055-179) | 115X96X50          | 7025    | 7330                  | 7635   | 7940   | 8245                             | 8550                      | 5730   | 5985     | 6240      |
| _J CONFIG (041-042)         | 66X40X40           | 3770    | 3920                  | 4070   | 4220   | 4370                             | 4520                      | 3210   | 3280     | 3350      |
| _K CONFIG (041-071-005)     | 90X62X40           | 5120    | 5315                  | 5510   | 5705   | 5900                             | 6095                      | 4265   | 4420     | 4575      |
| _L CONFIG (012-055-071-042) | 101X101X40         | 7590    | 7915                  | 8240   | 8565   | 8890                             | 9215                      | 6215   | 6440     | 6665      |
| _M CONFIG (041-071-055-089) | 101X89X40          | 6710    | 7030                  | 7350   | 7670   | 7990                             | 8310                      | 5495   | 5680     | 5865      |



# SEATTLE

**OPTIMA**  
Collection

**Jaymar**

Conçu et fabriqué fièrement au Canada  
Proudly designed and made in Canada

Nos produits sont fabriqués à la main et des variations mineures peuvent survenir.

Our product is hand-made and minor variations can occur.

## SPECIFICATIONS

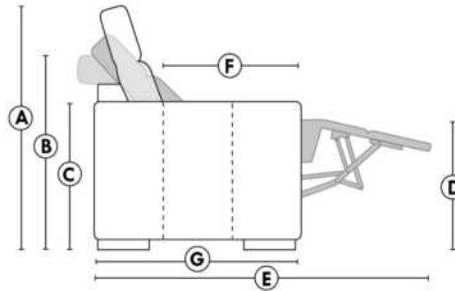

- Appui-tête levé / Headrest up
- Appui-tête baissé / Headrest down
- Complètement incliné / Fully reclined

- A** Hauteur complète 40" Total Height
- B** Hauteur appui-tête baissé 33" Height headrest down
- C** Hauteur du bras 24" Arm Height
- D** Hauteur du siège 19,5" Seat height
- E** Profondeur inclinée 65" Depth fully reclined
- F** Profondeur d'assise 20"ou/ou 22" Seat depth
- G** Profondeur appui-tête monté 37,5" Depth with headrest up

## BRAS | ARMS

Option de bras:  
Bras Régulier Large 9" ou Petit bras 6"

Arm option  
Regular arm Large 9" or Small arm 6"

Contrôle de l'inclinaison situé à l'intérieur du bras  
Recliner control located on the inside of the arm.

Option d'accessoires disponible sur le bras régulier seulement  
Accessories option, available on Regular arms ONLY.

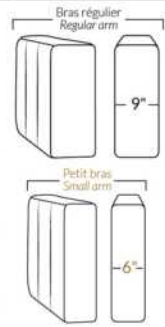

## FAUTEUIL BERÇANT PIVOTANT INCLINABLE SWIVEL ROCKING MOTION CHAIR



## SIÈGE 23" DE LARGE | 23" SEAT WIDTH

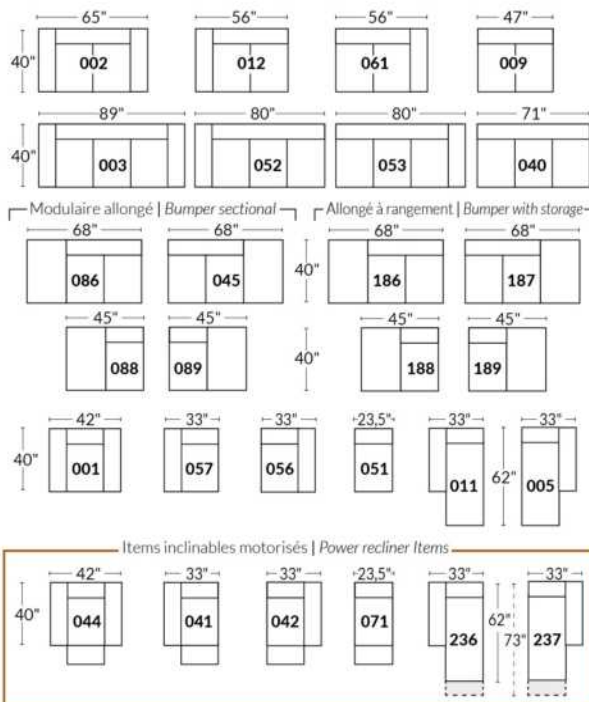

## SIÈGE 30" DE LARGE | 30" SEAT WIDTH

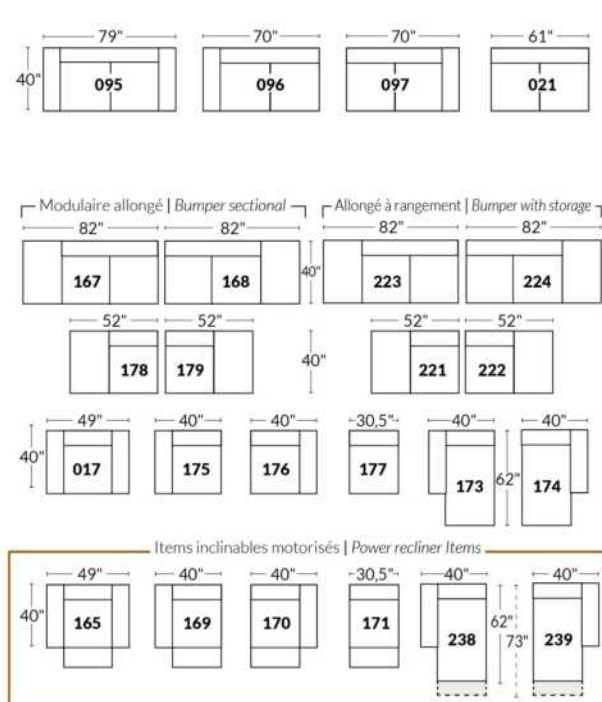

### Autres | Others

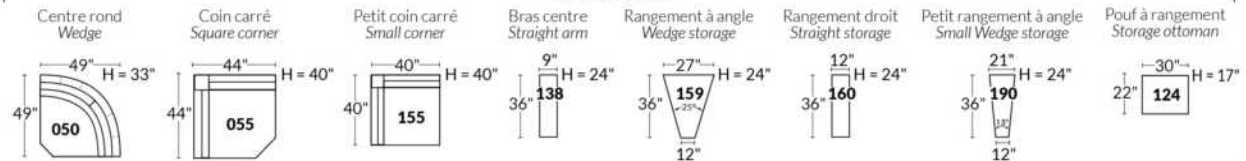

### EXEMPLE 23" EXAMPLE

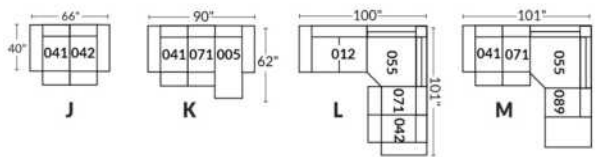

### EXEMPLE 30" EXAMPLE

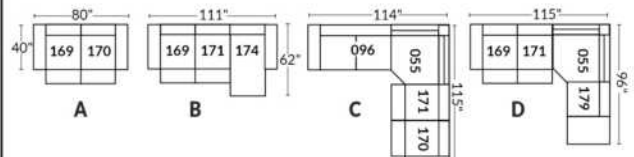

\*Available on certain models and on large arms ONLY.

### OPTIONS CUP HOLDERS

#### METAL



Silver



Matte Black



Brown

#### ILLUMINATED

1.



LED Lighted Cup holder

2.



LED Lighted Cup holder with Single Motor Control, USB Port and LED Base rail

3.



LED Lighted Cup holder with Dual Motor Control, USB Port and LED Base rail

Our illuminated one or two-control cup holders are compatible with LED lights under the seat. You can control the light on the cup holder. The 2 motor cup holder has a reset (home) button control to close your recliner back to its starting position.

#### LED Light under seat (Optional)

Available only in configurations with a minimum of 1 illuminated motorized cup holder with control buttons. The "light" button will control the opening and closing of the light.

For cup holder prices see description section of the Optima model price list.

Please provide us with a drawing of your configuration which indicates the cup holder type and its positioning.

#### Cup holder with controller:

It is important to specify the placement of the cups; on left arm or right arm and which recliner they will control. If you have a row of several seats with cup holders, by default, the controls will be on the left arms and on the right arm for the last outer chair.

#### EXAMPLE A:

041-169: Controller and cup holder on the left arm

071-171: hidden touch sensor buttons on side of seat

042-170: Controller and cup holder on right arm



#### EXAMPLE B:

071-171: These two items can be connected to a smart cup holder which will control the recliner. You must then use one of these items: 138,159, 160 and 190



#### Informations about headrest, controller on reclining seat

#### WITH illuminated cup holder

If you have a **stationary item**, you will have cup holder N°1.

If you have a recliner chair with a **manual headrest**, you will have the cup holder N°2.

If you have a recliner chair with an **electric headrest**, you will have cup holder N°3.

#### Without cup holder and with a reclining seat

If you have a recliner with a **manual headrest** you will have the touch sensor button control on the side of the seat.

If you have a recliner with an **electric headrest** you will have a dual push button controller with USB port on the arm.

If you have an **armless recliner**, you will have the hidden touch sensor button control.



Hidden touch sensor



Dual push button



# OPTIMA

## HOME THEATRE Configurations

\*Available on certain models and on large arms ONLY.

OPTIONS

### ACCESSORIES

Accessory Dock



V51 Wine Glass Holder



V52 Plastic Swivel Tray Table



V53 Wood Swivel tray Table  
(Choice of 8 colors)



Specify on which arm (left or right) the tray table will be installed.

V54 Tablet Holder



V55 LED Lamp



(For Accessory Dock price, see description section of the Optima model price list and for Accessory item prices, see at very end of the price list)

### Items 138-159-160-190 and large arm.

Accessory docks and cups are Optional. \*Not available on small arms\*

Please specify on which arms you want the accessory docks and cup holders.

NB: Item 138-159-160-190 are unfinished on the sides, must be used between 2 seats.

Each storage item has 2 USB ports and one electrical outlet inside the storage.



### SUGGESTED CONFIGURATIONS



## CDN Price List

### SHIRAZ

LEG: Specify colour of legs LG87 or LG96. Also available metal leg LG88.

COMBO: Cover #2 on back cushions only.

WEAVE LEATHER: Grade 40, available on arms and front of base. Use highest grade.

| Description                         | L x D x H    | Leather |                       |  |  |                                  |                           | Fabric |          |           |
|-------------------------------------|--------------|---------|-----------------------|--|--|----------------------------------|---------------------------|--------|----------|-----------|
|                                     |              | 10      | 20<br>Madras<br>Softy | 30<br>Hugo<br>Fantasy<br>Illusion<br>Tucson<br>Utah<br>Vintage<br>Wild Laredo<br>Yukon | 40<br>Elegance<br>Princess<br>Santiago<br>Sensation<br>Sunset<br>Trina<br>Victoria | 50<br>Bull<br>Cassiope<br>Dublin | 60<br>Caress<br>Ultrasued | A      | B<br>COM | C<br>alta |
| 001 CHAIR                           | 34X36X35     | 1360    | 1445                  | 1530   | 1615   | 1700                             | 1785                      | 1030   | 1085     | 1140      |
| 002 LOVESEAT                        | 57X36X35     | 1945    | 2045                  | 2145   | 2245   | 2345                             | 2445                      | 1410   | 1480     | 1550      |
| 003 SOFA                            | 80X36X35     | 2290    | 2425                  | 2560   | 2695   | 2830                             | 2965                      | 1740   | 1815     | 1890      |
| 005 LOUNGE CHAIR RIGHT ARM          | 29X62X35     | 1600    | 1685                  | 1770   | 1855   | 1940                             | 2025                      | 1170   | 1225     | 1280      |
| 006 OTTOMAN                         | 25.5X25.5X18 | 685     | 710                   | 735  | 760  | 785                              | 810                       | 550    | 570      | 590       |
| 009 ARMLESS LOVESEAT                | 46X36X35     | 1630    | 1745                  | 1860   | 1975   | 2090                             | 2205                      | 1200   | 1280     | 1360      |
| 011 LOUNGE CHAIR LEFT ARM           | 29X62X35     | 1600    | 1685                  | 1770   | 1855   | 1940                             | 2025                      | 1170   | 1225     | 1280      |
| 012 LOVESEAT LEFT ARM               | 52X36X35     | 1720    | 1820                  | 1920   | 2020   | 2120                             | 2220                      | 1320   | 1370     | 1420      |
| 018 ANGULAR LOVESEAT LEFT ARM       | 62X48X35     | 1645    | 1760                  | 1875   | 1990   | 2105                             | 2220                      | 1230   | 1310     | 1390      |
| 023 ANGULAR LOVESEAT RIGHT ARM      | 62X48X35     | 1645    | 1760                  | 1875   | 1990   | 2105                             | 2220                      | 1230   | 1310     | 1390      |
| 024 SECTIONAL LOVESEAT BUMPER RIGHT | 81X36X35     | 2355    | 2455                  | 2555   | 2655   | 2755                             | 2855                      | 1720   | 1790     | 1860      |
| 040 ARMLESS SOFA                    | 69X36X35     | 2070    | 2205                  | 2340   | 2475   | 2610                             | 2745                      | 1535   | 1615     | 1695      |
| 046 ARMLESS ANGULAR LOVESEAT        | 59X42X35     | 1360    | 1475                  | 1590   | 1705   | 1820                             | 1935                      | 1140   | 1205     | 1270      |
| 048 SECTIONAL LOVESEAT BUMPER LEFT  | 81X36X35     | 2355    | 2455                  | 2555   | 2655   | 2755                             | 2855                      | 1720   | 1790     | 1860      |
| 050 WEDGE                           | 47X47X35     | 1440    | 1515                  | 1590   | 1665   | 1740                             | 1815                      | 1080   | 1135     | 1190      |
| 051 ARMLESS CHAIR                   | 23X36X35     | 945     | 1020                  | 1095   | 1170   | 1245                             | 1320                      | 765    | 820      | 875       |
| 052 SOFA LEFT ARM                   | 75X36X35     | 2180    | 2320                  | 2460   | 2600   | 2740                             | 2880                      | 1635   | 1730     | 1825      |
| 053 SOFA RIGHT ARM                  | 75X36X35     | 2180    | 2320                  | 2460   | 2600   | 2740                             | 2880                      | 1635   | 1730     | 1825      |
| 056 CHAIR RIGHT ARM                 | 29X36X35     | 1175    | 1260                  | 1345   | 1430   | 1515                             | 1600                      | 945    | 995      | 1045      |
| 057 CHAIR LEFT ARM                  | 29X36X35     | 1175    | 1260                  | 1345   | 1430   | 1515                             | 1600                      | 945    | 995      | 1045      |
| 061 LOVESEAT RIGHT ARM              | 52X36X35     | 1720    | 1820                  | 1920   | 2020   | 2120                             | 2220                      | 1320   | 1370     | 1420      |
| 072 SECTIONAL SOFA LEFT ARM         | 87X36X35     | 2490    | 2625                  | 2760   | 2895   | 3030                             | 3165                      | 1835   | 1935     | 2035      |
| 073 SECTIONAL SOFA RIGHT ARM        | 87X36X35     | 2490    | 2625                  | 2760   | 2895   | 3030                             | 3165                      | 1835   | 1935     | 2035      |
| 080 ANGULAR OTTOMAN                 | 37X28X18     | 755     | 780                   | 805  | 830  | 855                              | 880                       | 645    | 670      | 695       |

# SHIRAZ



Hauteur complète 35" | Hauteur de siège 20" | Hauteur devant bras 27" | Profondeur d'assise 20"  
 Total Height 35" | Seat Height 20" | Arm Height 27" | Seat Depth 20"

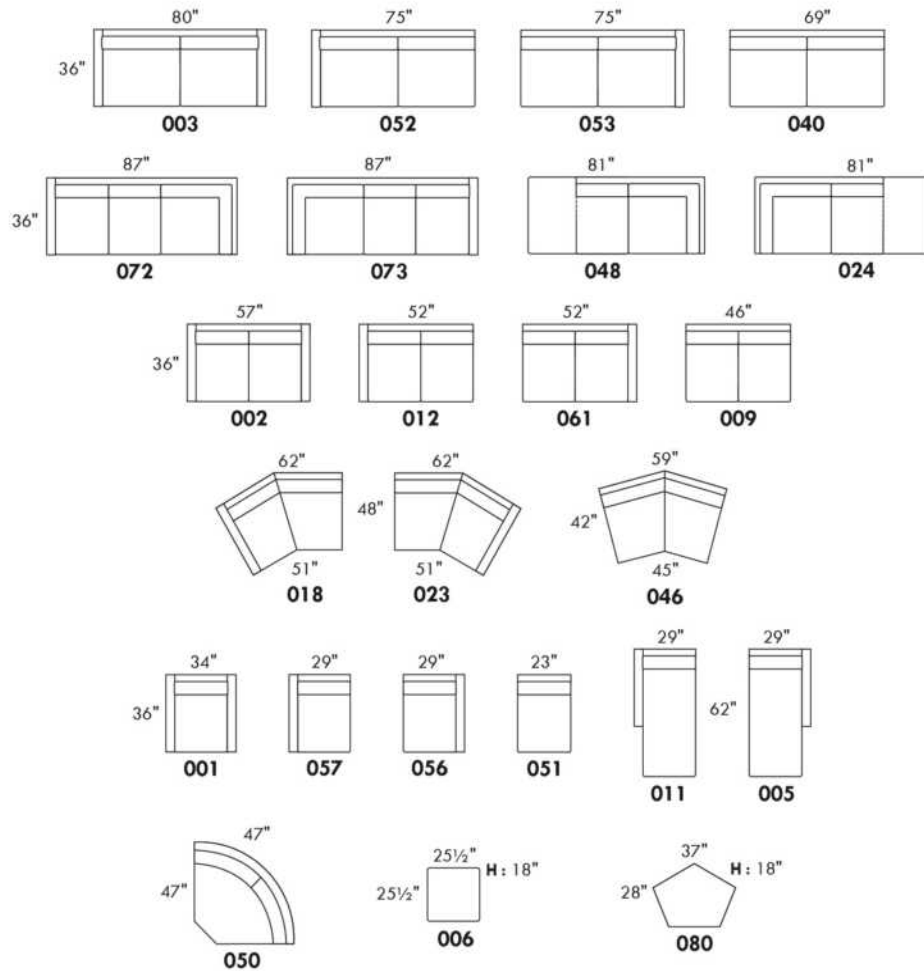

## CONFIGURATIONS

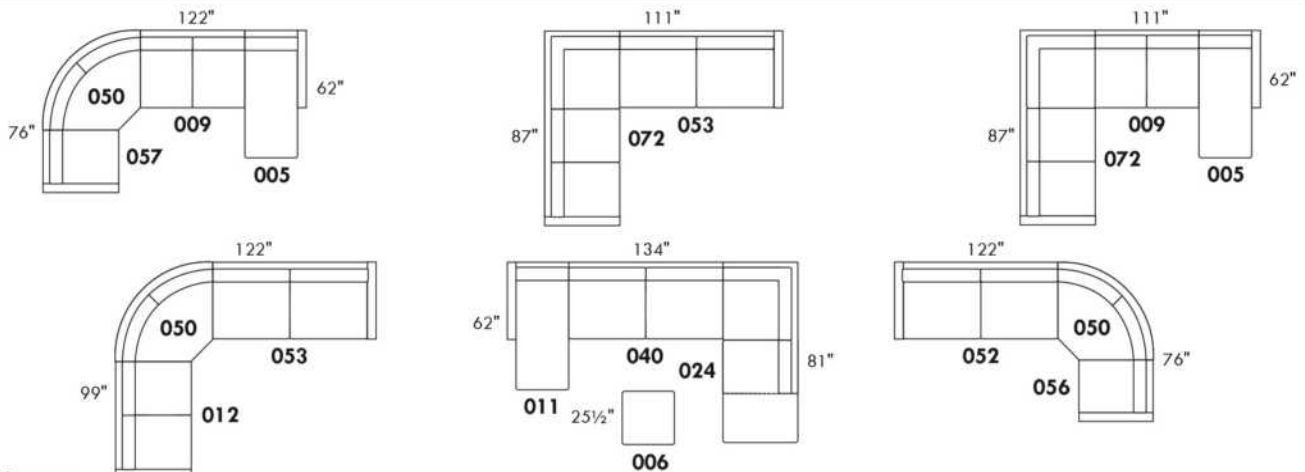

www.jaymar.ca

Toutes les dimensions indiquées sont au pouce près. Nos produits sont fabriqués à la main et des variations mineures peuvent survenir.  
 All dimensions indicated are to the nearest inch. Our product is hand-made and minor variations can occur.

## CDN Price List

### SILVANO

COMBO: Cover #2 on seat & back. In fabric: No decorative stitch on inside back cushion.  
Removable head-rest included with all items.

**OPTION:**

Motorized reclining mechanism with touch-sensor button add \$160/ mechanism. For motorized recliner mechanism with battery pack add \$320/ mechanism.

Note: 2 reclining seats separated by a wedge 45 or square corner cannot be opened at the same time.

| Description                       | L x D x H     | Leather |                       |  |  |                                  |                           | Fabric |          |           |
|-----------------------------------|---------------|---------|-----------------------|--|--|----------------------------------|---------------------------|--------|----------|-----------|
|                                   |               | 10      | 20<br>Madras<br>Softy | 30<br>Hugo<br>Fantasy<br>Illusion<br>Tucson<br>Utah<br>Vintage<br>Wild Laredo<br>Yukon | 40<br>Elegance<br>Princess<br>Santiago<br>Sensation<br>Sunset<br>Trina<br>Victoria | 50<br>Bull<br>Cassiope<br>Dublin | 60<br>Caress<br>Ultrasued | A      | B<br>COM | C<br>alta |
| 001 CHAIR                         | 37X40X36.5/43 | 1335    | 1425                  | 1515   | 1605   | 1695                             | 1785                      | 955    | 1005     | 1055      |
| 002 LOVESEAT                      | 60X40X36.5/43 | 1920    | 2035                  | 2150   | 2265   | 2380                             | 2495                      | 1320   | 1380     | 1440      |
| 003 SOFA                          | 83X40X36.5/43 | 2365    | 2520                  | 2675   | 2830   | 2985                             | 3140                      | 1670   | 1775     | 1880      |
| 005 LOUNGE CHAIR RIGHT ARM        | 30X62X36.5/43 | 1575    | 1660                  | 1745   | 1830   | 1915                             | 2000                      | 1100   | 1170     | 1240      |
| 009 ARMLESS LOVESEAT              | 46X40X36.5/43 | 1470    | 1585                  | 1700   | 1815   | 1930                             | 2045                      | 1080   | 1145     | 1210      |
| 011 LOUNGE CHAIR LEFT ARM         | 30X62X36.5/43 | 1575    | 1660                  | 1745   | 1830   | 1915                             | 2000                      | 1100   | 1170     | 1240      |
| 012 LOVESEAT LEFT ARM             | 53X40X36.5/43 | 1695    | 1805                  | 1915   | 2025   | 2135                             | 2245                      | 1175   | 1270     | 1365      |
| 017 DOUBLE CHAIR                  | 44X40X36.5/43 | 1440    | 1545                  | 1650   | 1755   | 1860                             | 1965                      | 1000   | 1060     | 1120      |
| 018 ANGULAR LOVESEAT LEFT ARM     | 67X53X36.5/43 | 1800    | 1930                  | 2060   | 2190   | 2320                             | 2450                      | 1295   | 1355     | 1415      |
| 021 APARTMENT SOFA NO ARM         | 60X40X36.5/43 | 1650    | 1790                  | 1930   | 2070   | 2210                             | 2350                      | 1155   | 1265     | 1375      |
| 023 ANGULAR LOVESEAT RIGHT ARM    | 67X53X36.5/43 | 1800    | 1930                  | 2060   | 2190   | 2320                             | 2450                      | 1295   | 1355     | 1415      |
| 040 ARMLESS SOFA                  | 69X40X36.5/43 | 1945    | 2085                  | 2225   | 2365   | 2505                             | 2645                      | 1445   | 1535     | 1625      |
| 041 RECLINING CHAIR LEFT ARM      | 30X40X36.5/43 | 1305    | 1390                  | 1475   | 1560   | 1645                             | 1730                      | 1020   | 1065     | 1110      |
| 042 RECLINING CHAIR RIGHT ARM     | 30X40X36.5/43 | 1305    | 1390                  | 1475   | 1560   | 1645                             | 1730                      | 1020   | 1065     | 1110      |
| 044 RECLINER CHAIR                | 37X40X36.5/43 | 1520    | 1610                  | 1700   | 1790   | 1880                             | 1970                      | 1140   | 1175     | 1210      |
| 045 ARMLESS LOVESEAT BUMPER RIGHT | 67X40X36.5/43 | 1735    | 1850                  | 1965   | 2080   | 2195                             | 2310                      | 1200   | 1285     | 1370      |
| 046 ARMLESS ANGULAR LOVESEAT      | 59X54X36.5/43 | 1620    | 1750                  | 1880   | 2010   | 2140                             | 2270                      | 1155   | 1240     | 1325      |
| 051 ARMLESS CHAIR                 | 23X40X36.5/43 | 910     | 1000                  | 1090   | 1180   | 1270                             | 1360                      | 740    | 775      | 810       |
| 052 SOFA LEFT ARM                 | 76X40X36.5/43 | 2145    | 2300                  | 2455   | 2610   | 2765                             | 2920                      | 1570   | 1655     | 1740      |
| 053 SOFA RIGHT ARM                | 76X40X36.5/43 | 2145    | 2300                  | 2455   | 2610   | 2765                             | 2920                      | 1570   | 1655     | 1740      |
| 055 SQUARE CORNER                 | 44X44X36.5/43 | 1340    | 1425                  | 1510   | 1595   | 1680                             | 1765                      | 1020   | 1075     | 1130      |
| 056 CHAIR RIGHT ARM               | 30X40X36.5/43 | 1120    | 1205                  | 1290   | 1375   | 1460                             | 1545                      | 835    | 890      | 945       |
| 057 CHAIR LEFT ARM                | 30X40X36.5/43 | 1120    | 1205                  | 1290   | 1375   | 1460                             | 1545                      | 835    | 890      | 945       |
| 061 LOVESEAT RIGHT ARM            | 53X40X36.5/43 | 1695    | 1805                  | 1915   | 2025   | 2135                             | 2245                      | 1175   | 1270     | 1365      |
| 062 ANGLE CHAIR LEFT ARM          | 67X53X36.5/43 | 1620    | 1710                  | 1800   | 1890   | 1980                             | 2070                      | 1145   | 1195     | 1245      |

## CDN Price List

### SILVANO

COMBO: Cover #2 on seat & back. In fabric: No decorative stitch on inside back cushion.  
Removable head-rest included with all items.

**OPTION:**

Motorized reclining mechanism with touch-sensor button add \$160/ mechanism. For motorized recliner mechanism with battery pack add \$320/ mechanism.

Note: 2 reclining seats separated by a wedge 45 or square corner cannot be opened at the same time.

| Description                            | L x D x H      | Leather |                       |  |  |                                  |                           | Fabric |          |           |
|--|----------------|---------|-----------------------|--|--|----------------------------------|---------------------------|--------|----------|-----------|
|  |                | 10      | 20<br>Madras<br>Softy | 30<br>Hugo<br>Fantasy<br>Illusion<br>Tucson<br>Utah<br>Vintage<br>Wild Laredo<br>Yukon | 40<br>Elegance<br>Princess<br>Santiago<br>Sensation<br>Sunset<br>Trina<br>Victoria | 50<br>Bull<br>Cassiope<br>Dublin | 60<br>Caress<br>Ultrasued | A      | B<br>COM | C<br>alta |
| 063 ANGLE CHAIR RIGHT ARM              | 67X53X36.5/43  | 1620    | 1710                  | 1800   | 1890   | 1980                             | 2070                      | 1145   | 1195     | 1245      |
| 071 ARMLESS RECLINING CHAIR            | 23X40X36.5/43  | 1100    | 1180                  | 1260   | 1340   | 1420                             | 1500                      | 925    | 975      | 1025      |
| 080 ANGULAR OTTOMAN                    | 36X27X18       | 705     | 730                   | 755  | 780  | 805                              | 830                       | 600    | 610      | 620       |
| 086 ARMLESS LOVESEAT BUMPER LEFT       | 67X40X36.5/43  | 1735    | 1850                  | 1965   | 2080   | 2195                             | 2310                      | 1200   | 1285     | 1370      |
| 088 ARMLESS CHAIR BUMPER LEFT          | 44X40X36.5/43  | 1135    | 1245                  | 1355   | 1465   | 1575                             | 1685                      | 875    | 910      | 945       |
| 089 ARMLESS CHAIR BUMPER RIGHT         | 44X40X36.5/43  | 1135    | 1245                  | 1355   | 1465   | 1575                             | 1685                      | 875    | 910      | 945       |
| 095 APARTMENT SOFA                     | 74X40X36.5/43  | 2100    | 2250                  | 2400   | 2550   | 2700                             | 2850                      | 1410   | 1500     | 1590      |
| 096 APARTMENT SOFA LEFT ARM            | 67X40X36.5/43  | 1880    | 2025                  | 2170   | 2315   | 2460                             | 2605                      | 1295   | 1365     | 1435      |
| 097 APARTMENT SOFA RIGHT ARM           | 67X40X36.5/43  | 1880    | 2025                  | 2170   | 2315   | 2460                             | 2605                      | 1295   | 1365     | 1435      |
| 124 STORAGE OTTOMAN                    | 30X22X18       | 705     | 730                   | 755  | 780  | 805                              | 830                       | 605    | 615      | 625       |
| 148 WEDGE 45                           | 47X47X36.5/43  | 1150    | 1250                  | 1350   | 1450   | 1550                             | 1650                      | 880    | 940      | 1000      |
| 165 DOUBLE RECLINING CHAIR             | 44X40X36.5/43  | 1620    | 1725                  | 1830   | 1935   | 2040                             | 2145                      | 1175   | 1250     | 1325      |
| 167 APARTMENT SOFA NO ARM BUMPER LEFT  | 81X40X36.5/43  | 1920    | 2055                  | 2190   | 2325   | 2460                             | 2595                      | 1305   | 1380     | 1455      |
| 168 APARTMENT SOFA NO ARM BUMPER RIGHT | 81X40X36.5/43  | 1920    | 2055                  | 2190   | 2325   | 2460                             | 2595                      | 1305   | 1380     | 1455      |
| 169 DOUBLE RECLINING CHAIR LEFT ARM    | 37X40X36.5/43  | 1400    | 1500                  | 1600   | 1700   | 1800                             | 1900                      | 1055   | 1125     | 1195      |
| 170 DOUBLE RECLINING CHAIR RIGHT ARM   | 37X40X36.5/43  | 1400    | 1500                  | 1600   | 1700   | 1800                             | 1900                      | 1055   | 1125     | 1195      |
| 171 ARMLESS DOUBLE RECLINING CHAIR     | 30X40X36.5/43  | 1175    | 1285                  | 1395   | 1505   | 1615                             | 1725                      | 975    | 1040     | 1105      |
| 173 DOUBLE LOUNGE CHAIR LEFT ARM       | 37X62X36.5/43  | 1765    | 1870                  | 1975   | 2080   | 2185                             | 2290                      | 1180   | 1290     | 1400      |
| 174 DOUBLE LOUNGE CHAIR RIGHT ARM      | 37X62X36.5/43  | 1765    | 1870                  | 1975   | 2080   | 2185                             | 2290                      | 1180   | 1290     | 1400      |
| 175 DOUBLE CHAIR LEFT ARM              | 37X40X36.5/43  | 1215    | 1320                  | 1425   | 1530   | 1635                             | 1740                      | 890    | 950      | 1010      |
| 176 DOUBLE CHAIR RIGHT ARM             | 37X40X36.5/43  | 1215    | 1320                  | 1425   | 1530   | 1635                             | 1740                      | 890    | 950      | 1010      |
| 177 ARMLESS DOUBLE CHAIR               | 30X40X36.5/43  | 1000    | 1100                  | 1200   | 1300   | 1400                             | 1500                      | 785    | 865      | 945       |
| 178 ARMLESS DOUBLE CHAIR BUMPER LEFT   | 51X40X36.5/43  | 1260    | 1340                  | 1420   | 1500   | 1580                             | 1660                      | 910    | 985      | 1060      |
| 179 ARMLESS DOUBLE CHAIR BUMPER RIGHT  | 51X40X36.5/43  | 1260    | 1340                  | 1420   | 1500   | 1580                             | 1660                      | 910    | 985      | 1060      |
| <b>CONFIGURATIONS</b>                  |                |         |                       |  |  |                                  |                           |        |          |           |
| A CONFIG. (169-177-174)                | 104X62X36.5/43 | 4165    | 4470                  | 4775   | 5080   | 5385                             | 5690                      | 3020   | 3280     | 3540      |

## CDN Price List

### SILVANO

| Description                 | L x D x H       | Leather |                       |  |  |                                  |                           | Fabric |          |           |
|-----------------------------|-----------------|---------|-----------------------|--|--|----------------------------------|---------------------------|--------|----------|-----------|
|                             |                 | 10      | 20<br>Madras<br>Softy | 30<br>Hugo<br>Fantasy<br>Illusion<br>Tucson<br>Utah<br>Vintage<br>Wild Laredo<br>Yukon | 40<br>Elegance<br>Princess<br>Santiago<br>Sensation<br>Sunset<br>Trina<br>Victoria | 50<br>Bull<br>Cassiope<br>Dublin | 60<br>Caress<br>Ultrasued | A      | B<br>COM | C<br>alta |
| B CONFIG. (96-55-177-170)   | 111X111X36.5/43 | 5620    | 6050                  | 6480   | 6910   | 7340                             | 7770                      | 4155   | 4430     | 4705      |
| C CONFIG. (173-177-055-179) | 111X95X36.5/43  | 5365    | 5735                  | 6105   | 6475   | 6845                             | 7215                      | 3895   | 4215     | 4535      |
| D CONFIG. (011-009-005)     | 106X62X36.5/43  | 4620    | 4905                  | 5190   | 5475   | 5760                             | 6045                      | 3280   | 3485     | 3690      |
| E CONFIG. (018-071-023)     | 157X53X36.5/43  | 4700    | 5040                  | 5380   | 5720   | 6060                             | 6400                      | 3515   | 3685     | 3855      |
| F CONFIG. (41-51-148-51-42) | 144X67X36.5/43  | 5580    | 6030                  | 6480   | 6930   | 7380                             | 7830                      | 4400   | 4620     | 4840      |

# SILVANO



Hauteur complète 36½"/43" | Hauteur de siège 18" | Profondeur d'assise 20"  
 Total Height 36½"/43" | Seat Height 18" | Seat Depth 20"

## SIÈGE 30" DE LARGE | 30" SEAT WIDTH

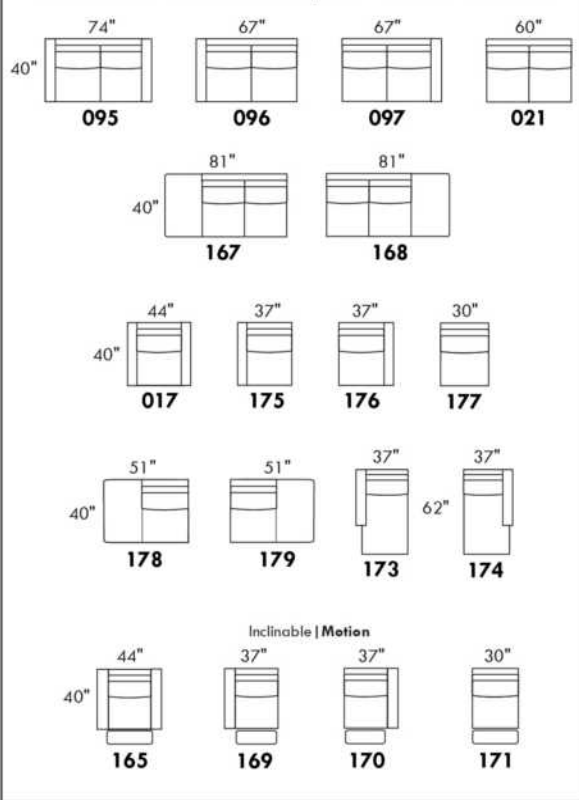

## SIÈGE 23" DE LARGE | 23" SEAT WIDTH

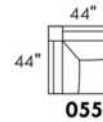
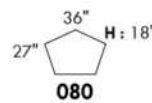
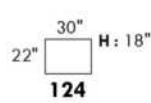
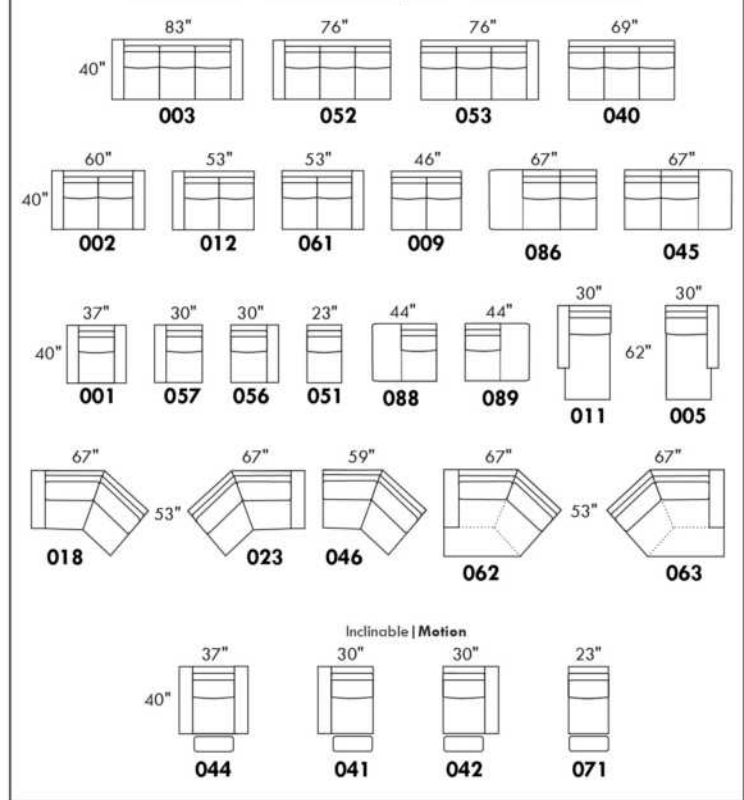

## CONFIGURATIONS

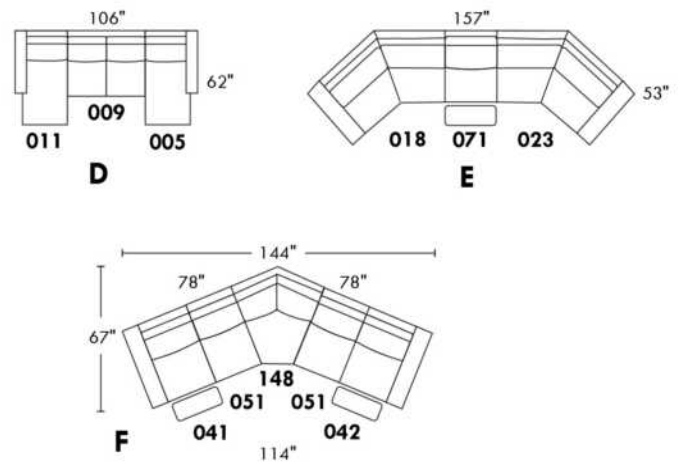
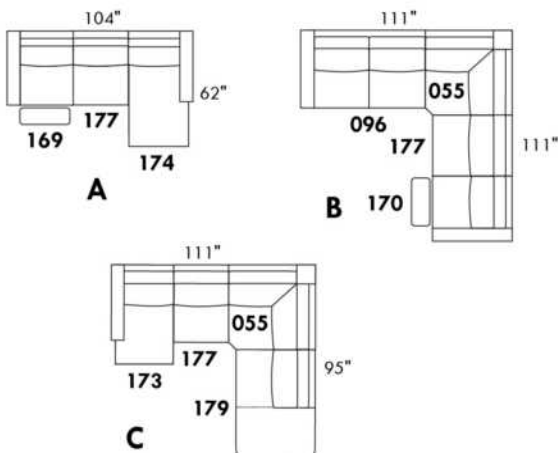

www.jaymar.ca  
 Toutes les dimensions indiquées sont au pouce près. Nos produits sont fabriqués à la main et des variations mineures peuvent survenir.  
 All dimensions indicated are to the nearest inch. Our product is hand-made and minor variations can occur.

## SORRENTO

**FEATURES:**

- Manual adjustable headrest on all items (2 on square corner & stationary on wedge).
- \*Wall hugger power recliners with full footrest (manual n/a).
- Power recliner lounge chair (manual n/a) with power headrest in option. Wall clearance 8" & front 5".
- Seat cushions with shaped foam + 1" layer of memory foam on top; arm with memory foam.
- Stitching: Small thread in fabric & large flat thread in leather.
- \*Excludes 043 & 163 chairs: Wall clearance 16"

Note: 2 recliner seats separated by a corner can not be opened at the same time. No recliner seats beside item #155.

**OPTIONS**

- Battery Pack: Add \$160/ea.
- \*Motorized headrest: Add \$160 ea. (\*N/A on stationary items).
- Foam: Extra firm add \$15/seat.
- Choice of Large or Small 6" Arm: Leg on LARGE arm: LG106 wood or LG189 metal (Black or Chrome). SMALL Arm: LG195 wood or LG196 metal (Black or Chrome). Specify colour.
- Seat Depth: 20" or \*22". \*22" seat depth N/A on chairs 043 & 163.
- 043 & 163 Chairs: with wood base (specify colour).

| Description                        | L x D x H     | Leather |                       |  |  |                                  |                           | Fabric |          |           |
|------------------------------------|---------------|---------|-----------------------|--|--|----------------------------------|---------------------------|--------|----------|-----------|
|                                    |               | 10      | 20<br>Madras<br>Softy | 30<br>Hugo<br>Fantasy<br>Illusion<br>Tucson<br>Utah<br>Vintage<br>Wild Laredo<br>Yukon | 40<br>Elegance<br>Princess<br>Santiago<br>Sensation<br>Sunset<br>Trina<br>Victoria | 50<br>Bull<br>Cassiope<br>Dublin | 60<br>Caress<br>Ultrasued | A      | B<br>COM | C<br>alta |
| 001 CHAIR                          | 46x40x33/40   | 1890    | 1980                  | 2070   | 2160   | 2250                             | 2340                      | 1535   | 1580     | 1625      |
| 002 LOVESEAT                       | 69x40x33/40   | 2700    | 2815                  | 2930   | 3045   | 3160                             | 3275                      | 2175   | 2250     | 2325      |
| 003 SOFA                           | 93x40x33/40   | 3265    | 3415                  | 3565   | 3715   | 3865                             | 4015                      | 2625   | 2715     | 2805      |
| 005 LOUNGE CHAIR RIGHT ARM         | 35x62x33/40   | 1765    | 1830                  | 1895   | 1960   | 2025                             | 2090                      | 1410   | 1470     | 1530      |
| 009 ARMLESS LOVESEAT               | 47x40x33/40   | 1895    | 1965                  | 2035   | 2105   | 2175                             | 2245                      | 1490   | 1570     | 1650      |
| 011 LOUNGE CHAIR LEFT ARM          | 35x62x33/40   | 1765    | 1830                  | 1895   | 1960   | 2025                             | 2090                      | 1410   | 1470     | 1530      |
| 012 LOVESEAT LEFT ARM              | 58x40x33/40   | 2320    | 2420                  | 2520   | 2620   | 2720                             | 2820                      | 1850   | 1925     | 2000      |
| 017 DOUBLE CHAIR                   | 53x40x33/40   | 1980    | 2080                  | 2180   | 2280   | 2380                             | 2480                      | 1600   | 1660     | 1720      |
| 021 APARTMENT SOFA NO ARM          | 61x40x33/40   | 2140    | 2240                  | 2340   | 2440   | 2540                             | 2640                      | 1670   | 1755     | 1840      |
| 040 ARMLESS SOFA                   | 71x40x33/40   | 2450    | 2565                  | 2680   | 2795   | 2910                             | 3025                      | 1950   | 2040     | 2130      |
| 041 RECLINING CHAIR LEFT ARM       | 35x40x33/40   | 1885    | 1960                  | 2035   | 2110   | 2185                             | 2260                      | 1605   | 1640     | 1675      |
| 042 RECLINING CHAIR RIGHT ARM      | 35x40x33/40   | 1885    | 1960                  | 2035   | 2110   | 2185                             | 2260                      | 1605   | 1640     | 1675      |
| 043 SWIVEL ROCKING RECLINING CHAIR | 30x34x42      | 2235    | 2345                  | 2455   | 2565   | 2675                             | 2785                      | 1875   | 1920     | 1965      |
| 044 RECLINER CHAIR                 | 46x40x33/40   | 2275    | 2365                  | 2455   | 2545   | 2635                             | 2725                      | 1920   | 1970     | 2020      |
| 045 ARMLESS LOVESEAT BUMPER RIGHT  | 68x40x33/40   | 2245    | 2340                  | 2435   | 2530   | 2625                             | 2720                      | 1785   | 1850     | 1915      |
| 050 WEDGE                          | 49x49x33      | 1645    | 1745                  | 1845   | 1945   | 2045                             | 2145                      | 1210   | 1270     | 1330      |
| 051 ARMLESS CHAIR                  | 23,5x40x33/40 | 1085    | 1135                  | 1185   | 1235   | 1285                             | 1335                      | 845    | 900      | 955       |
| 052 SOFA LEFT ARM                  | 82x40x33/40   | 2870    | 3005                  | 3140   | 3275   | 3410                             | 3545                      | 2290   | 2385     | 2480      |
| 053 SOFA RIGHT ARM                 | 82x40x33/40   | 2870    | 3005                  | 3140   | 3275   | 3410                             | 3545                      | 2290   | 2385     | 2480      |



## SORRENTO

**FEATURES:**

- Manual adjustable headrest on all items (2 on square corner & stationary on wedge).
- \*Wall hugger power recliners with full footrest (manual n/a).
- Power recliner lounge chair (manual n/a) with power headrest in option. Wall clearance 8" & front 5".
- Seat cushions with shaped foam + 1" layer of memory foam on top; arm with memory foam.
- Stitching: Small thread in fabric & large flat thread in leather.

\*Excludes 043 & 163 chairs: Wall clearance 16"

Note: 2 recliner seats separated by a corner can not be opened at the same time. No recliner seats beside item #155.

**OPTIONS**

- Battery Pack: Add \$160/ea.
- \*Motorized headrest: Add \$160 ea. (\*N/A on stationary items).
- Foam: Extra firm add \$15/seat.
- Choice of Large or Small 6" Arm: Leg on LARGE arm: LG106 wood or LG189 metal (Black or Chrome). SMALL Arm: LG195 wood or LG196 metal (Black or Chrome). Specify colour.
- Seat Depth: 20" or \*22". \*22" seat depth N/A on chairs 043 & 163.
- 043 & 163 Chairs: with wood base (specify colour).

| Description                            | L x D x H     | Leather |                       |  |  |                                  |                           | Fabric |          |           |
|--|---------------|---------|-----------------------|--|--|----------------------------------|---------------------------|--------|----------|-----------|
|  |               | 10      | 20<br>Madras<br>Softy | 30<br>Hugo<br>Fantasy<br>Illusion<br>Tucson<br>Utah<br>Vintage<br>Wild Laredo<br>Yukon | 40<br>Elegance<br>Princess<br>Santiago<br>Sensation<br>Sunset<br>Trina<br>Victoria | 50<br>Bull<br>Cassiope<br>Dublin | 60<br>Caress<br>Ultrasued | A      | B<br>COM | C<br>alta |
| 055 SQUARE CORNER                      | 44x44x33/40   | 1915    | 2010                  | 2105   | 2200   | 2295                             | 2390                      | 1510   | 1565     | 1620      |
| 056 CHAIR RIGHT ARM                    | 35x40x33/40   | 1510    | 1575                  | 1640   | 1705   | 1770                             | 1835                      | 1200   | 1260     | 1320      |
| 057 CHAIR LEFT ARM                     | 35x40x33/40   | 1510    | 1575                  | 1640   | 1705   | 1770                             | 1835                      | 1200   | 1260     | 1320      |
| 061 LOVESEAT RIGHT ARM                 | 58x40x33/40   | 2320    | 2420                  | 2520   | 2620   | 2720                             | 2820                      | 1850   | 1925     | 2000      |
| 071 ARMLESS RECLINING CHAIR            | 23,5x40x33/40 | 1470    | 1525                  | 1580   | 1635   | 1690                             | 1745                      | 1250   | 1310     | 1370      |
| 086 ARMLESS LOVESEAT BUMPER LEFT       | 68x40x33/40   | 2245    | 2340                  | 2435   | 2530   | 2625                             | 2720                      | 1785   | 1850     | 1915      |
| 088 ARMLESS CHAIR BUMPER LEFT          | 45x40x33/40   | 1440    | 1535                  | 1630   | 1725   | 1820                             | 1915                      | 1130   | 1165     | 1200      |
| 089 ARMLESS CHAIR BUMPER RIGHT         | 45x40x33/40   | 1440    | 1535                  | 1630   | 1725   | 1820                             | 1915                      | 1130   | 1165     | 1200      |
| 095 APARTMENT SOFA                     | 83x40x33/40   | 2940    | 3085                  | 3230   | 3375   | 3520                             | 3665                      | 2350   | 2445     | 2540      |
| 096 APARTMENT SOFA LEFT ARM            | 72x40x33/40   | 2570    | 2680                  | 2790   | 2900   | 3010                             | 3120                      | 2020   | 2110     | 2200      |
| 097 APARTMENT SOFA RIGHT ARM           | 72x40x33/40   | 2570    | 2680                  | 2790   | 2900   | 3010                             | 3120                      | 2020   | 2110     | 2200      |
| 124 STORAGE OTTOMAN                    | 30x22x17      | 745     | 765                   | 785  | 805  | 825                              | 845                       | 650    | 670      | 690       |
| 155 SMALL SQUARE CORNER                | 40x40x33/40   | 1915    | 2010                  | 2105   | 2200   | 2295                             | 2390                      | 1510   | 1565     | 1620      |
| 163 DBL SWIVEL ROCKING RECLINER CHAIR  | 33x34x42      | 2290    | 2410                  | 2530   | 2650   | 2770                             | 2890                      | 1880   | 1930     | 1980      |
| 165 DOUBLE RECLINING CHAIR             | 53x40x33/40   | 2375    | 2475                  | 2575   | 2675   | 2775                             | 2875                      | 2000   | 2065     | 2130      |
| 167 APARTMENT SOFA NO ARM BUMPER LEFT  | 82x40x33/40   | 2490    | 2620                  | 2750   | 2880   | 3010                             | 3140                      | 1960   | 2045     | 2130      |
| 168 APARTMENT SOFA NO ARM BUMPER RIGHT | 82x40x33/40   | 2490    | 2620                  | 2750   | 2880   | 3010                             | 3140                      | 1960   | 2045     | 2130      |
| 169 DOUBLE RECLINING CHAIR LEFT ARM    | 42x40x33/40   | 1990    | 2070                  | 2150   | 2230   | 2310                             | 2390                      | 1670   | 1750     | 1830      |
| 170 DOUBLE RECLINING CHAIR RIGHT ARM   | 42x40x33/40   | 1990    | 2070                  | 2150   | 2230   | 2310                             | 2390                      | 1670   | 1750     | 1830      |
| 171 ARMLESS DOUBLE RECLINING CHAIR     | 30,5x40x33/40 | 1575    | 1625                  | 1675   | 1725   | 1775                             | 1825                      | 1320   | 1380     | 1440      |

## SORRENTO

### FEATURES:

- Manual adjustable headrest on all items (2 on square corner & stationary on wedge).
- \*Wall hugger power recliners with full footrest (manual n/a).
- Power recliner lounge chair (manual n/a) with power headrest in option. Wall clearance 8" & front 5".
- Seat cushions with shaped foam + 1" layer of memory foam on top; arm with memory foam.
- Stitching: Small thread in fabric & large flat thread in leather.
- \*Excludes 043 & 163 chairs: Wall clearance 16"

Note: 2 recliner seats separated by a corner can not be opened at the same time. No recliner seats beside item #155.

### OPTIONS

- Battery Pack: Add \$160/ea.
- \*Motorized headrest: Add \$160 ea. (\*N/A on stationary items).
- Foam: Extra firm add \$15/seat.
- Choice of Large or Small 6" Arm: Leg on LARGE arm: LG106 wood or LG189 metal (Black or Chrome). SMALL Arm: LG195 wood or LG196 metal (Black or Chrome). Specify colour.
- Seat Depth: 20" or \*22". \*22" seat depth N/A on chairs 043 & 163.
- 043 & 163 Chairs: with wood base (specify colour).

| Description                            | L x D x H     | Leather |                       |  |  |                                  |                           | Fabric |          |           |
|--|---------------|---------|-----------------------|--|--|----------------------------------|---------------------------|--------|----------|-----------|
|  |               | 10      | 20<br>Madras<br>Softy | 30<br>Hugo<br>Fantasy<br>Illusion<br>Tucson<br>Utah<br>Vintage<br>Wild Laredo<br>Yukon | 40<br>Elegance<br>Princess<br>Santiago<br>Sensation<br>Sunset<br>Trina<br>Victoria | 50<br>Bull<br>Cassiope<br>Dublin | 60<br>Caress<br>Ultrasued | A      | B<br>COM | C<br>alta |
| 173 DOUBLE LOUNGE CHAIR LEFT ARM       | 42x62x33/40   | 1915    | 2005                  | 2095   | 2185   | 2275                             | 2365                      | 1535   | 1615     | 1695      |
| 174 DOUBLE LOUNGE CHAIR RIGHT ARM      | 42x62x33/40   | 1915    | 2005                  | 2095   | 2185   | 2275                             | 2365                      | 1535   | 1615     | 1695      |
| 175 DOUBLE CHAIR LEFT ARM              | 42x40x33/40   | 1590    | 1680                  | 1770   | 1860   | 1950                             | 2040                      | 1285   | 1350     | 1415      |
| 176 DOUBLE CHAIR RIGHT ARM             | 42x40x33/40   | 1590    | 1680                  | 1770   | 1860   | 1950                             | 2040                      | 1285   | 1350     | 1415      |
| 177 ARMLESS DOUBLE CHAIR               | 30,5x40x33/40 | 1185    | 1250                  | 1315   | 1380   | 1445                             | 1510                      | 915    | 970      | 1025      |
| 178 ARMLESS DOUBLE CHAIR BUMPER LEFT   | 52x40x33/40   | 1545    | 1625                  | 1705   | 1785   | 1865                             | 1945                      | 1230   | 1290     | 1350      |
| 179 ARMLESS DOUBLE CHAIR BUMPER RIGHT  | 52x40x33/40   | 1545    | 1625                  | 1705   | 1785   | 1865                             | 1945                      | 1230   | 1290     | 1350      |
| 186 ARMLESS LOVESEAT BUMPER STORAGE-L  | 68x40x33/40   | 2420    | 2500                  | 2580   | 2660   | 2740                             | 2820                      | 1950   | 2015     | 2080      |
| 187 ARMLESS LOVESEAT BUMPER STORAGE-R  | 68x40x33/40   | 2420    | 2500                  | 2580   | 2660   | 2740                             | 2820                      | 1950   | 2015     | 2080      |
| 188 ARMLESS CHAIR BUMPER STORAGE-L     | 45x40x33/40   | 1600    | 1690                  | 1780   | 1870   | 1960                             | 2050                      | 1295   | 1330     | 1365      |
| 189 ARMLESS CHAIR BUMPER STORAGE-R     | 45x40x33/40   | 1600    | 1690                  | 1780   | 1870   | 1960                             | 2050                      | 1295   | 1330     | 1365      |
| 221 ARMLESS DBL CHAIR BUMPER STORAGE-L | 52x40x33/40   | 1705    | 1790                  | 1875   | 1960   | 2045                             | 2130                      | 1390   | 1450     | 1510      |
| 222 ARMLESS DBL CHAIR BUMPER STORAGE-R | 52x40x33/40   | 1705    | 1790                  | 1875   | 1960   | 2045                             | 2130                      | 1390   | 1450     | 1510      |
| 223 APT SOFA NO ARM BUMPER STORAGE-L   | 82x40x33/40   | 2655    | 2785                  | 2915   | 3045   | 3175                             | 3305                      | 2120   | 2215     | 2310      |
| 224 APT SOFA NO ARM BUMPER STORAGE-R   | 82x40x33/40   | 2655    | 2785                  | 2915   | 3045   | 3175                             | 3305                      | 2120   | 2215     | 2310      |
| 236 RECLINING LOUNGE CHAIR LEFT ARM    | 35x62x33/40   | 2160    | 2225                  | 2290   | 2355   | 2420                             | 2485                      | 1820   | 1880     | 1940      |
| 237 RECLINING LOUNGE CHAIR RIGHT ARM   | 35x62x33/40   | 2160    | 2225                  | 2290   | 2355   | 2420                             | 2485                      | 1820   | 1880     | 1940      |
| 238 RECLINING DBL LOUNGE CHAIR L-ARM   | 42x62x33/40   | 2315    | 2405                  | 2495   | 2585   | 2675                             | 2765                      | 1940   | 2020     | 2100      |
| 239 RECLINING DBL LOUNGE CHAIR R-ARM   | 42x62x33/40   | 2315    | 2405                  | 2495   | 2585   | 2675                             | 2765                      | 1940   | 2020     | 2100      |
| <b>CONFIGURATIONS</b>                  |               |         |                       |  |  |                                  |                           |        |          |           |

## CDN Price List

### SORRENTO

| Description                | L x D x H  | Leather |                       |  |  |                                  |                           | Fabric |          |           |
|----------------------------|------------|---------|-----------------------|--|--|----------------------------------|---------------------------|--------|----------|-----------|
|                            |            | 10      | 20<br>Madras<br>Softy | 30<br>Hugo<br>Fantasy<br>Illusion<br>Tucson<br>Utah<br>Vintage<br>Wild Laredo<br>Yukon | 40<br>Elegance<br>Princess<br>Santiago<br>Sensation<br>Sunset<br>Trina<br>Victoria | 50<br>Bull<br>Cassiope<br>Dublin | 60<br>Caress<br>Ultrasued | A      | B<br>COM | C<br>alta |
| A CONFIG (169-170)         | 84X40X40   | 3980    | 4140                  | 4300   | 4460   | 4620                             | 4780                      | 3340   | 3500     | 3660      |
| B CONFIG (169-171-174)     | 115X62X40  | 5480    | 5700                  | 5920   | 6140   | 6360                             | 6580                      | 4525   | 4745     | 4965      |
| C CONFIG (096-055-171-170) | 116X116X40 | 8050    | 8385                  | 8720   | 9055   | 9390                             | 9725                      | 6520   | 6805     | 7090      |
| D CONFIG (169-171-055-179) | 116X96X40  | 7025    | 7330                  | 7635   | 7940   | 8245                             | 8550                      | 5730   | 5985     | 6240      |
| J CONFIG (041-042)         | 70X40X40   | 3770    | 3920                  | 4070   | 4220   | 4370                             | 4520                      | 3210   | 3280     | 3350      |
| K CONFIG (041-071-005)     | 94X62X40   | 5120    | 5315                  | 5510   | 5705   | 5900                             | 6095                      | 4265   | 4420     | 4575      |
| L CONFIG (012-055-071-042) | 102X102X40 | 7590    | 7915                  | 8240   | 8565   | 8890                             | 9215                      | 6215   | 6440     | 6665      |
| M CONFIG (041-071-055-089) | 103X89X40  | 6710    | 7030                  | 7350   | 7670   | 7990                             | 8310                      | 5495   | 5680     | 5865      |



# SORRENTO

**OPTIMA**  
Collection

**Jaymar**

Conçu et fabriqué fièrement au Canada  
Proudly designed and made in Canada

Nos produits sont fabriqués à la main et  
des variations mineures peuvent survenir

Our product is hand-made and minor variations can occur.

## SPECIFICATIONS

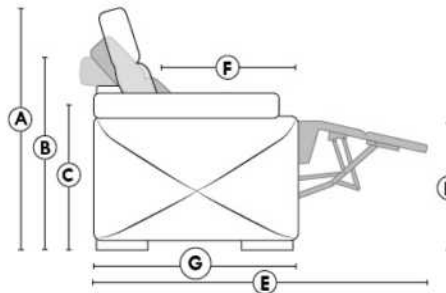

- Appui-tête levé Headrest up
- Appui-tête baissé Headrest down
- Complètement incliné Fully reclined

- A** Hauteur complète 40" Total Height
- B** Hauteur appui-tête baissé 33" Height headrest down
- C** Hauteur du bras 22,5" Arm Height
- D** Hauteur du siège 19,5" Seat height
- E** Profondeur inclinée 65" Depth fully reclined
- F** Profondeur d'assise 20"ou/ou 22" Seat depth
- G** Profondeur appui-tête monté 37,5" Depth with headrest up

## BRAS | ARMS

Option de bras:  
Bras Régulier Large 11" ou Petit bras 6"

Arm option  
Regular arm Large 11" or Small arm 6"

Contrôle de l'inclinaison situé à l'extérieur du bras  
Recliner control located on the outside of the arm.

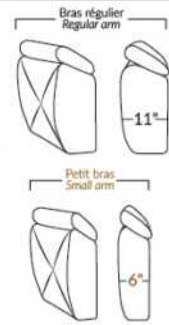

## FAUTEUIL BERÇANT PIVOTANT INCLINABLE SWIVEL ROCKING MOTION CHAIR

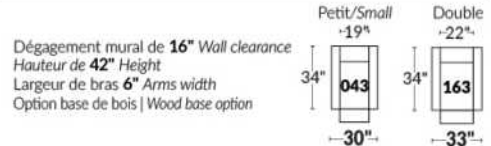

## SIÈGE 23" DE LARGE | 23" SEAT WIDTH

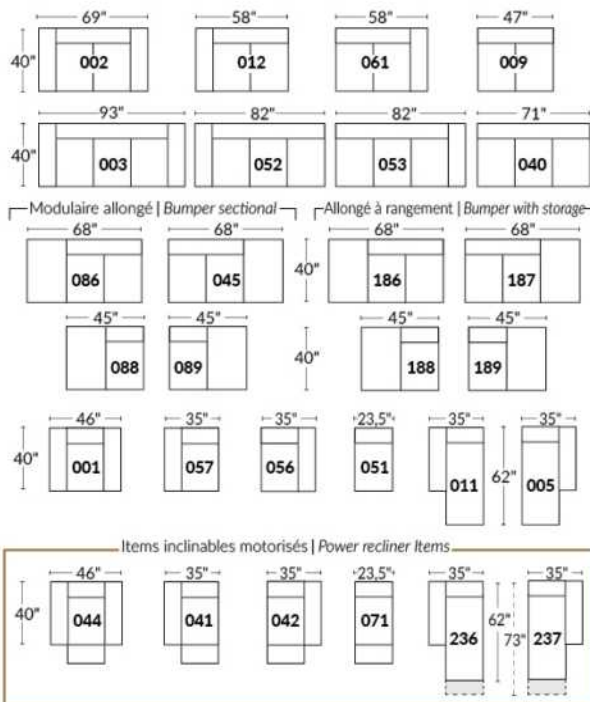

## SIÈGE 30" DE LARGE | 30" SEAT WIDTH

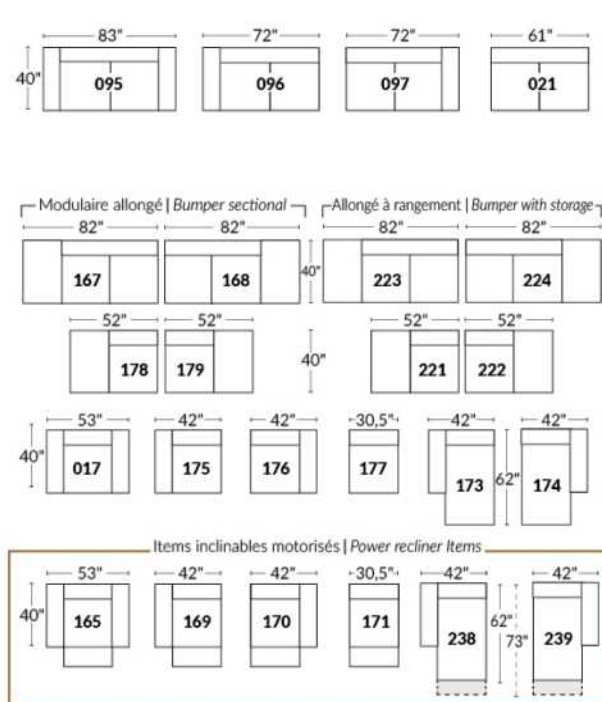

## Autres | Others

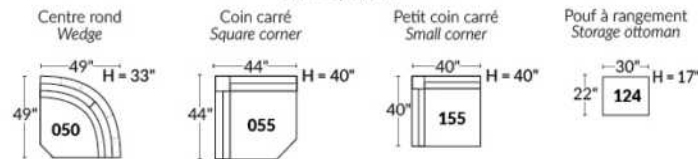

## EXEMPLE 23" EXAMPLE

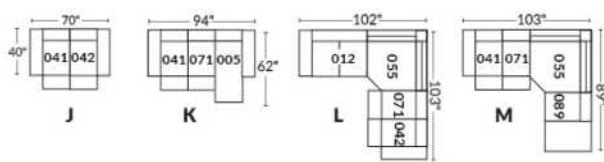

## EXEMPLE 30" EXAMPLE

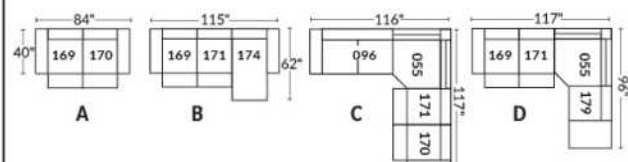

## STAR

Features: Manual adjustable headrest included with all items (2 with square corner). Headrest STATIONARY on Wedge (050). Stitching: Small "French Stitch" in fabric & in leather. Swivel Rocking Recliner Chairs (items 043 & 163 only): seat cushions with 1" memory foam.

Note: 2 recliner seats separated by a wedge (050) or square corner (055) cannot be opened at the same time.

OPTIONS - Provide SKETCH of your config.:

Small 6" Arm: at same price.

Leg (specify colour): On LARGE Arm: LG103 wood or LG189 metal (Black or Chrome). SMALL Arm: LG08 wood or LG64 metal.

Choice of Seat Depth: 20" or \*22". The \*22" seat depth N/A on chairs #043 & #163.

043 & 163 Chairs: with wood base (specify colour).

Foam (Extra Firm or Memory): Add \$15/seat. Bumper section counts as 1 seat & lounge chairs as 2 seats.

Motorized recliner mechanism with touch-sensor button add \$160/mechanism. | For Battery Pack: add \$320/mechanism.

| Description                        | L x D x H     | Leather |                       |  |  |                                  |                           | Fabric |          |           |
|------------------------------------|---------------|---------|-----------------------|--|--|----------------------------------|---------------------------|--------|----------|-----------|
|                                    |               | 10      | 20<br>Madras<br>Softy | 30<br>Hugo<br>Fantasy<br>Illusion<br>Tucson<br>Utah<br>Vintage<br>Wild Laredo<br>Yukon | 40<br>Elegance<br>Princess<br>Santiago<br>Sensation<br>Sunset<br>Trina<br>Victoria | 50<br>Bull<br>Cassiope<br>Dublin | 60<br>Caress<br>Ultrasued | A      | B<br>COM | C<br>alta |
| 001 CHAIR                          | 44X40X33/40   | 1630    | 1725                  | 1820   | 1915   | 2010                             | 2105                      | 1235   | 1295     | 1355      |
| 002 LOVESEAT                       | 67X40X33/40   | 2365    | 2485                  | 2605   | 2725   | 2845                             | 2965                      | 1800   | 1865     | 1930      |
| 003 SOFA                           | 91X40X33/40   | 2890    | 3045                  | 3200   | 3355   | 3510                             | 3665                      | 2180   | 2275     | 2370      |
| 005 LOUNGE CHAIR RIGHT ARM         | 34X62X33/40   | 1555    | 1625                  | 1695   | 1765   | 1835                             | 1905                      | 1155   | 1225     | 1295      |
| 009 ARMLESS LOVESEAT               | 47X40X33/40   | 1770    | 1835                  | 1900   | 1965   | 2030                             | 2095                      | 1330   | 1390     | 1450      |
| 011 LOUNGE CHAIR LEFT ARM          | 34X62X33/40   | 1555    | 1625                  | 1695   | 1765   | 1835                             | 1905                      | 1155   | 1225     | 1295      |
| 012 LOVESEAT LEFT ARM              | 57X40X33/40   | 2070    | 2160                  | 2250   | 2340   | 2430                             | 2520                      | 1575   | 1640     | 1705      |
| 017 DOUBLE CHAIR                   | 51X40X33/40   | 1750    | 1840                  | 1930   | 2020   | 2110                             | 2200                      | 1320   | 1370     | 1420      |
| 021 APARTMENT SOFA NO ARM          | 61X40X33/40   | 2010    | 2090                  | 2170   | 2250   | 2330                             | 2410                      | 1510   | 1600     | 1690      |
| 040 ARMLESS SOFA                   | 71X40X33/40   | 2280    | 2360                  | 2440   | 2520   | 2600                             | 2680                      | 1725   | 1815     | 1905      |
| 041 RECLINING CHAIR LEFT ARM       | 34X40X33/40   | 1495    | 1575                  | 1655   | 1735   | 1815                             | 1895                      | 1175   | 1230     | 1285      |
| 042 RECLINING CHAIR RIGHT ARM      | 34X40X33/40   | 1495    | 1575                  | 1655   | 1735   | 1815                             | 1895                      | 1175   | 1230     | 1285      |
| 043 SWIVEL ROCKING RECLINING CHAIR | 30x34x42      | 1965    | 2060                  | 2155   | 2250   | 2345                             | 2440                      | 1600   | 1645     | 1690      |
| 044 RECLINER CHAIR                 | 44X40X33/40   | 1805    | 1910                  | 2015   | 2120   | 2225                             | 2330                      | 1425   | 1480     | 1535      |
| 045 ARMLESS LOVESEAT BUMPER RIGHT  | 68X40X33/40   | 2080    | 2175                  | 2270   | 2365   | 2460                             | 2555                      | 1580   | 1650     | 1720      |
| 050 WEDGE                          | 49X49X33      | 1555    | 1640                  | 1725   | 1810   | 1895                             | 1980                      | 1100   | 1150     | 1200      |
| 051 ARMLESS CHAIR                  | 23,5X40X33/40 | 1005    | 1055                  | 1105   | 1155   | 1205                             | 1255                      | 765    | 820      | 875       |
| 052 SOFA LEFT ARM                  | 81X40X33/40   | 2590    | 2695                  | 2800   | 2905   | 3010                             | 3115                      | 1950   | 2040     | 2130      |
| 053 SOFA RIGHT ARM                 | 81X40X33/40   | 2590    | 2695                  | 2800   | 2905   | 3010                             | 3115                      | 1950   | 2040     | 2130      |
| 055 SQUARE CORNER                  | 44X44X33/40   | 1825    | 1925                  | 2025   | 2125   | 2225                             | 2325                      | 1390   | 1455     | 1520      |
| 056 CHAIR RIGHT ARM                | 34X40X33/40   | 1320    | 1395                  | 1470   | 1545   | 1620                             | 1695                      | 1000   | 1045     | 1090      |
| 057 CHAIR LEFT ARM                 | 34X40X33/40   | 1320    | 1395                  | 1470   | 1545   | 1620                             | 1695                      | 1000   | 1045     | 1090      |

## STAR

Features: Manual adjustable headrest included with all items (2 with square corner). Headrest STATIONARY on Wedge (050). Stitching: Small "French Stitch" in fabric & in leather. Swivel Rocking Recliner Chairs (items 043 & 163 only): seat cushions with 1" memory foam.

Note: 2 recliner seats separated by a wedge (050) or square corner (055) cannot be opened at the same time.

OPTIONS - Provide SKETCH of your config.:

Small 6" Arm: at same price.

Leg (specify colour): On LARGE Arm: LG103 wood or LG189 metal (Black or Chrome). SMALL Arm: LG08 wood or LG64 metal.

Choice of Seat Depth: 20" or \*22". The \*22" seat depth N/A on chairs #043 & #163.

043 & 163 Chairs: with wood base (specify colour).

Foam (Extra Firm or Memory): Add \$15/seat. Bumper section counts as 1 seat & lounge chairs as 2 seats.

Motorized recliner mechanism with touch-sensor button add \$160/mechanism. | For Battery Pack: add \$320/mechanism.

| Description                            | L x D x H     | Leather |                       |  |  |                                  |                           | Fabric |          |           |
|--|---------------|---------|-----------------------|--|--|----------------------------------|---------------------------|--------|----------|-----------|
|  |               | 10      | 20<br>Madras<br>Softy | 30<br>Hugo<br>Fantasy<br>Illusion<br>Tucson<br>Utah<br>Vintage<br>Wild Laredo<br>Yukon | 40<br>Elegance<br>Princess<br>Santiago<br>Sensation<br>Sunset<br>Trina<br>Victoria | 50<br>Bull<br>Cassiope<br>Dublin | 60<br>Caress<br>Ultrasued | A      | B<br>COM | C<br>alta |
| 061 LOVESEAT RIGHT ARM                 | 57X40X33/40   | 2070    | 2160                  | 2250   | 2340   | 2430                             | 2520                      | 1575   | 1640     | 1705      |
| 071 ARMLESS RECLINING CHAIR            | 23,5X40X33/40 | 1185    | 1250                  | 1315   | 1380   | 1445                             | 1510                      | 955    | 1020     | 1085      |
| 086 ARMLESS LOVESEAT BUMPER LEFT       | 68X40X33/40   | 2080    | 2175                  | 2270   | 2365   | 2460                             | 2555                      | 1580   | 1650     | 1720      |
| 088 ARMLESS CHAIR BUMPER LEFT          | 45X40X33/40   | 1330    | 1410                  | 1490   | 1570   | 1650                             | 1730                      | 1005   | 1050     | 1095      |
| 089 ARMLESS CHAIR BUMPER RIGHT         | 45X40X33/40   | 1330    | 1410                  | 1490   | 1570   | 1650                             | 1730                      | 1005   | 1050     | 1095      |
| 095 APARTMENT SOFA                     | 81X40X33/40   | 2625    | 2780                  | 2935   | 3090   | 3245                             | 3400                      | 1980   | 2070     | 2160      |
| 096 APARTMENT SOFA LEFT ARM            | 71X40X33/40   | 2315    | 2430                  | 2545   | 2660   | 2775                             | 2890                      | 1750   | 1835     | 1920      |
| 097 APARTMENT SOFA RIGHT ARM           | 71X40X33/40   | 2315    | 2430                  | 2545   | 2660   | 2775                             | 2890                      | 1750   | 1835     | 1920      |
| 124 STORAGE OTTOMAN                    | 30X22X17      | 705     | 730                   | 755  | 780  | 805                              | 830                       | 605    | 615      | 625       |
| 163 DBL SWIVEL ROCKING RECLINER CHAIR  | 33 x 34 x 42  | 2010    | 2125                  | 2240   | 2355   | 2470                             | 2585                      | 1605   | 1650     | 1695      |
| 165 DOUBLE RECLINING CHAIR             | 51X40X33/40   | 1920    | 2025                  | 2130   | 2235   | 2340                             | 2445                      | 1495   | 1565     | 1635      |
| 167 APARTMENT SOFA NO ARM BUMPER LEFT  | 82X40X33/40   | 2320    | 2440                  | 2560   | 2680   | 2800                             | 2920                      | 1770   | 1855     | 1940      |
| 168 APARTMENT SOFA NO ARM BUMPER RIGHT | 82X40X33/40   | 2320    | 2440                  | 2560   | 2680   | 2800                             | 2920                      | 1770   | 1855     | 1940      |
| 169 DOUBLE RECLINING CHAIR LEFT ARM    | 41X40X33/40   | 1605    | 1690                  | 1775   | 1860   | 1945                             | 2030                      | 1285   | 1335     | 1385      |
| 170 DOUBLE RECLINING CHAIR RIGHT ARM   | 41X40X33/40   | 1605    | 1690                  | 1775   | 1860   | 1945                             | 2030                      | 1285   | 1335     | 1385      |
| 171 ARMLESS DOUBLE RECLINING CHAIR     | 30,5X40X33/40 | 1305    | 1355                  | 1405   | 1455   | 1505                             | 1555                      | 1030   | 1095     | 1160      |
| 173 DOUBLE LOUNGE CHAIR LEFT ARM       | 41X62X33/40   | 1695    | 1785                  | 1875   | 1965   | 2055                             | 2145                      | 1295   | 1375     | 1455      |
| 174 DOUBLE LOUNGE CHAIR RIGHT ARM      | 41X62X33/40   | 1695    | 1785                  | 1875   | 1965   | 2055                             | 2145                      | 1295   | 1375     | 1455      |
| 175 DOUBLE CHAIR LEFT ARM              | 41X40X33/40   | 1420    | 1500                  | 1580   | 1660   | 1740                             | 1820                      | 1085   | 1145     | 1205      |
| 176 DOUBLE CHAIR RIGHT ARM             | 41X40X33/40   | 1420    | 1500                  | 1580   | 1660   | 1740                             | 1820                      | 1085   | 1145     | 1205      |
| 177 ARMLESS DOUBLE CHAIR               | 30,5X40X33/40 | 1120    | 1175                  | 1230   | 1285   | 1340                             | 1395                      | 845    | 905      | 965       |
| 178 ARMLESS DOUBLE CHAIR BUMPER LEFT   | 52X40X33/40   | 1440    | 1535                  | 1630   | 1725   | 1820                             | 1915                      | 1095   | 1150     | 1205      |

## STAR

Features: Manual adjustable headrest included with all items (2 with square corner). Headrest STATIONARY on Wedge (050). Stitching: Small "French Stitch" in fabric & in leather. Swivel Rocking Recliner Chairs (items 043 & 163 only): seat cushions with 1" memory foam.

Note: 2 recliner seats separated by a wedge (050) or square corner (055) cannot be opened at the same time.

OPTIONS - Provide SKETCH of your config.:

Small 6" Arm: at same price.

Leg (specify colour): On LARGE Arm: LG103 wood or LG189 metal (Black or Chrome). SMALL Arm: LG08 wood or LG64 metal.

Choice of Seat Depth: 20" or \*22". The \*22" seat depth N/A on chairs #043 & #163.

043 & 163 Chairs: with wood base (specify colour).

Foam (Extra Firm or Memory): Add \$15/seat. Bumper section counts as 1 seat & lounge chairs as 2 seats.

Motorized recliner mechanism with touch-sensor button add \$160/mechanism. | For Battery Pack: add \$320/mechanism.

| Description                           | L x D x H       | Leather |                       |  |  |                                  |                           | Fabric |          |           |
|---------------------------------------|-----------------|---------|-----------------------|--|--|----------------------------------|---------------------------|--------|----------|-----------|
|                                       |                 | 10      | 20<br>Madras<br>Softy | 30<br>Hugo<br>Fantasy<br>Illusion<br>Tucson<br>Utah<br>Vintage<br>Wild Laredo<br>Yukon | 40<br>Elegance<br>Princess<br>Santiago<br>Sensation<br>Sunset<br>Trina<br>Victoria | 50<br>Bull<br>Cassiope<br>Dublin | 60<br>Caress<br>Ultrasued | A      | B<br>COM | C<br>alta |
| 179 ARMLESS DOUBLE CHAIR BUMPER RIGHT | 52X40X33/40     | 1440    | 1535                  | 1630   | 1725   | 1820                             | 1915                      | 1095   | 1150     | 1205      |
| <b>CONFIGURATIONS</b>                 |                 |         |                       |  |  |                                  |                           |        |          |           |
| A CONFIG (169-170)                    | 82X40X33/40     | 3210    | 3380                  | 3550   | 3720   | 3890                             | 4060                      | 2570   | 2670     | 2770      |
| B CONFIG (169-171-174)                | 113X62X33/40    | 4605    | 4830                  | 5055   | 5280   | 5505                             | 5730                      | 3610   | 3805     | 4000      |
| C CONFIG (096-055-171-170)            | 115X116X33/40   | 7050    | 7400                  | 7750   | 8100   | 8450                             | 8800                      | 5455   | 5720     | 5985      |
| D CONFIG (169-171-055-179)            | 169-171-055-179 | 6175    | 6505                  | 6835   | 7165   | 7495                             | 7825                      | 4800   | 5035     | 5270      |
| J CONFIG (041-042)                    | 68X40X33/40     | 2990    | 3150                  | 3310   | 3470   | 3630                             | 3790                      | 2350   | 2460     | 2570      |
| K CONFIG (041-071-005)                | 92X62X33/40     | 4235    | 4450                  | 4665   | 4880   | 5095                             | 5310                      | 3285   | 3475     | 3665      |
| L CONFIG (012-055-071-042)            | 101X89X33/40    | 6575    | 6910                  | 7245   | 7580   | 7915                             | 8250                      | 5095   | 5345     | 5595      |
| M CONFIG (041-071-055-089)            | 102X89X33/40    | 5835    | 6160                  | 6485   | 6810   | 7135                             | 7460                      | 4525   | 4755     | 4985      |



# STAR

PARALLELE  
Collection 33

Jaymar

Conçu et fabriqué fièrement au Canada  
Proudly designed and made in Canada

Nos produits sont fabriqués à la main et des variations mineures peuvent survenir.

Our product is hand-made and minor variations can occur.

## SPECIFICATIONS

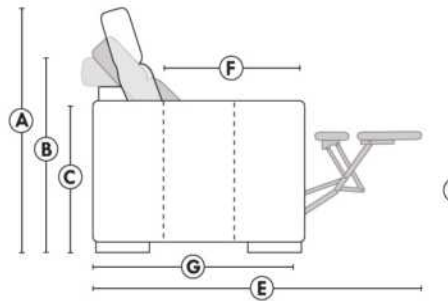

- Appui-tête levé Headrest up
- Appui-tête baissé Headrest down
- Complètement incliné Fully reclined

- A** Hauteur complète 40" Total Height
- B** Hauteur appui-tête baissé 33" Height headrest down
- C** Hauteur du bras 24" Arm Height
- D** Hauteur du siège 19,5" Seat height
- E** Profondeur inclinée 65" Depth fully reclined
- F** Profondeur d'assise 20" ou/ou 22" Seat depth
- G** Profondeur appui-tête monté 37,5" Depth with headrest up

## BRAS | ARMS

Option de bras:  
Bras Régulier Large 10" ou Petit bras 6"

Arm option  
Regular arm Large 10" or Small arm 6"

Contrôle de l'inclinaison situé à l'intérieur du bras  
Recliner control located on the inside of the arm.

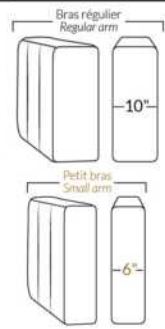

## FAUTEUIL BERÇANT PIVOTANT INCLINABLE SWIVEL ROCKING MOTION CHAIR

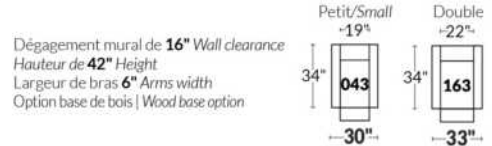

## SIÈGE 23" DE LARGE | 23" SEAT WIDTH

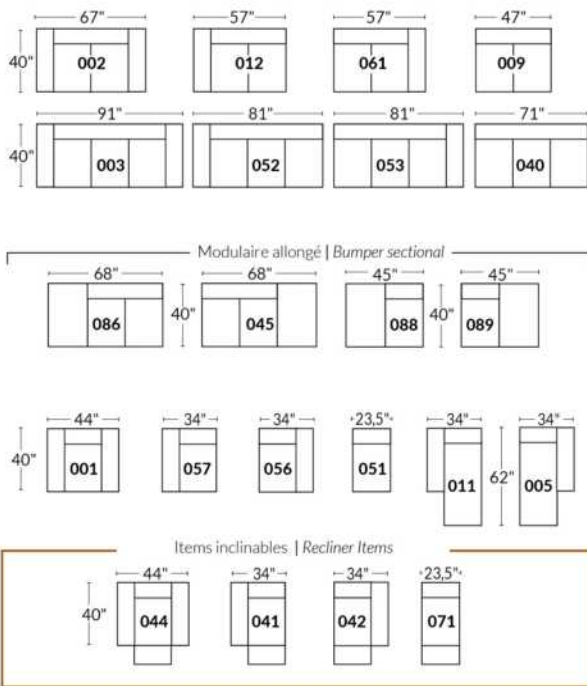

## SIÈGE 30" DE LARGE | 30" SEAT WIDTH

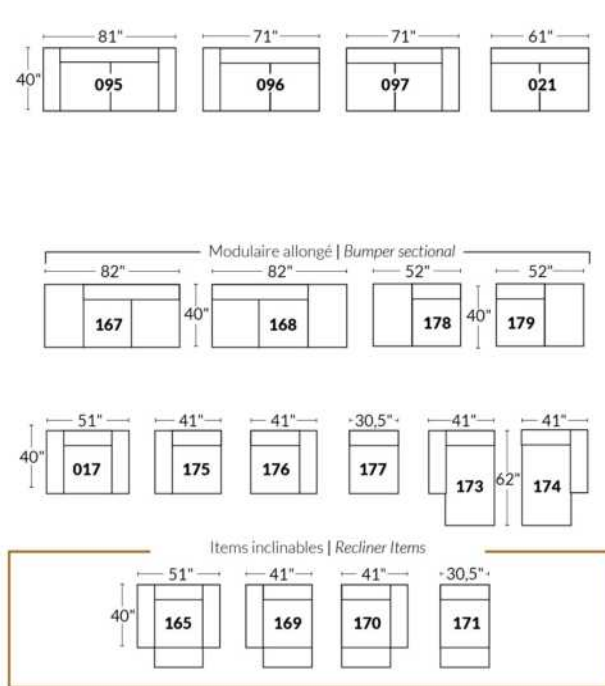

### Autres | Others

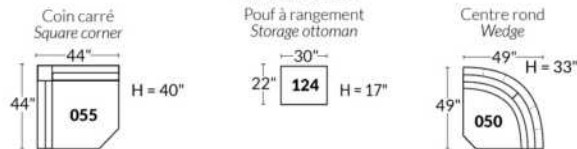

### EXEMPLE 23" EXAMPLE

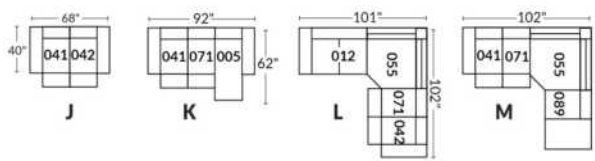

### EXEMPLE 30" EXAMPLE

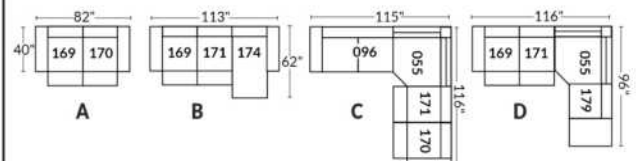



## SYDNEY

### FEATURES:

- Manual adjustable headrest on all items (2 on square corner & stationary on wedge).
- \*Wall hugger power recliners with full footrest (manual n/a).
- Power recliner lounge chair (manual n/a) with power headrest in option. Wall clearance 8" & front 5".
- Seat cushions with shaped foam + 1" layer of memory foam on top; arm with memory foam.
- Stitching: Small thread in fabric & large flat thread in leather.

\*Excludes 043 & 163 chairs: Wall clearance 16"

Note: 2 recliner seats separated by a corner can not be opened at the same time. No recliner seats beside item #155.

### OPTIONS

- Battery Pack: Add \$160/ea.
- \*Motorized headrest: Add \$160 ea. (\*N/A on stationary & lounge chair items).
- Foam: Extra firm add \$15/seat.
- Choice of Large or Small 6" Arm: Leg on LARGE arm: LG103 wood or LG189 metal (Black or Chrome). SMALL Arm: LG08 wood or LG196 metal (Black or Chrome). Specify colour.
- Seat Depth: 20" or \*22". \*22" seat depth N/A on chairs 043 & 163.
- 043 & 163 Chairs: with wood base (specify colour).

### HOME THEATRE Configurations

For Accessories, Cup holders & Configuration details, see Optima Home Theatre page attached.

Accessory Dock : \$35 ea.

Cup Holders: Metal: \$25 ea. | LED lighted Cup Holder: \$25 ea. | \*LED lighted Cup Holder with (1 or 2 motor) controls: \$40 ea.

\*LED Light strip under seat: \$25/seat.

| Description                        | L x D x H   | Leather |                       |  |  |                                  |                            | Fabric |          |           |
|------------------------------------|-------------|---------|-----------------------|--|--|----------------------------------|----------------------------|--------|----------|-----------|
|                                    |             | 10      | 20<br>Madras<br>Softy | 30<br>Hugo<br>Fantasy<br>Illusion<br>Tucson<br>Utah<br>Vintage<br>Wild Laredo<br>Yukon | 40<br>Elegance<br>Princess<br>Santiago<br>Sensation<br>Sunset<br>Trina<br>Victoria | 50<br>Bull<br>Cassiope<br>Dublin | 60<br>Caresse<br>Ultrasued | A      | B<br>COM | C<br>alta |
| 001 CHAIR                          | 45x40x33/40 | 1890    | 1980                  | 2070   | 2160   | 2250                             | 2340                       | 1535   | 1580     | 1625      |
| 002 LOVESEAT                       | 68x40x33/40 | 2700    | 2815                  | 2930   | 3045   | 3160                             | 3275                       | 2175   | 2250     | 2325      |
| 003 SOFA                           | 92x40x33/40 | 3265    | 3415                  | 3565   | 3715   | 3865                             | 4015                       | 2625   | 2715     | 2805      |
| 005 LOUNGE CHAIR RIGHT ARM         | 35x62x33/40 | 1765    | 1830                  | 1895   | 1960   | 2025                             | 2090                       | 1410   | 1470     | 1530      |
| 009 ARMLESS LOVESEAT               | 47x40x33/40 | 1895    | 1965                  | 2035   | 2105   | 2175                             | 2245                       | 1490   | 1570     | 1650      |
| 011 LOUNGE CHAIR LEFT ARM          | 35x62x33/40 | 1765    | 1830                  | 1895   | 1960   | 2025                             | 2090                       | 1410   | 1470     | 1530      |
| 012 LOVESEAT LEFT ARM              | 58x40x33/40 | 2320    | 2420                  | 2520   | 2620   | 2720                             | 2820                       | 1850   | 1925     | 2000      |
| 017 DOUBLE CHAIR                   | 52x40x33/40 | 1980    | 2080                  | 2180   | 2280   | 2380                             | 2480                       | 1600   | 1660     | 1720      |
| 021 APARTMENT SOFA NO ARM          | 61x40x33/40 | 2140    | 2240                  | 2340   | 2440   | 2540                             | 2640                       | 1670   | 1755     | 1840      |
| 040 ARMLESS SOFA                   | 71x40x33/40 | 2450    | 2565                  | 2680   | 2795   | 2910                             | 3025                       | 1950   | 2040     | 2130      |
| 041 RECLINING CHAIR LEFT ARM       | 35x40x33/40 | 1885    | 1960                  | 2035   | 2110   | 2185                             | 2260                       | 1605   | 1640     | 1675      |
| 042 RECLINING CHAIR RIGHT ARM      | 35x40x33/40 | 1885    | 1960                  | 2035   | 2110   | 2185                             | 2260                       | 1605   | 1640     | 1675      |
| 043 SWIVEL ROCKING RECLINING CHAIR | 30x34x42    | 2235    | 2345                  | 2455   | 2565   | 2675                             | 2785                       | 1875   | 1920     | 1965      |
| 044 RECLINER CHAIR                 | 45x40x33/40 | 2275    | 2365                  | 2455   | 2545   | 2635                             | 2725                       | 1920   | 1970     | 2020      |
| 045 ARMLESS LOVESEAT BUMPER RIGHT  | 68x40x33/40 | 2245    | 2340                  | 2435   | 2530   | 2625                             | 2720                       | 1785   | 1850     | 1915      |
| 050 WEDGE                          | 49x49x33    | 1645    | 1745                  | 1845   | 1945   | 2045                             | 2145                       | 1210   | 1270     | 1330      |

## SYDNEY

**FEATURES:**

- Manual adjustable headrest on all items (2 on square corner & stationary on wedge).
- \*Wall hugger power recliners with full footrest (manual n/a).
- Power recliner lounge chair (manual n/a) with power headrest in option. Wall clearance 8" & front 5".
- Seat cushions with shaped foam + 1" layer of memory foam on top; arm with memory foam.
- Stitching: Small thread in fabric & large flat thread in leather.
- \*Excludes 043 & 163 chairs: Wall clearance 16"

Note: 2 recliner seats separated by a corner can not be opened at the same time. No recliner seats beside item #155.

**OPTIONS**

- Battery Pack: Add \$160/ea.
- \*Motorized headrest: Add \$160 ea. (\*N/A on stationary & lounge chair items).
- Foam: Extra firm add \$15/seat.
- Choice of Large or Small 6" Arm: Leg on LARGE arm: LG103 wood or LG189 metal (Black or Chrome). SMALL Arm: LG08 wood or LG196 metal (Black or Chrome). Specify colour.
- Seat Depth: 20" or \*22". \*22" seat depth N/A on chairs 043 & 163.
- 043 & 163 Chairs: with wood base (specify colour).

**HOME THEATRE Configurations**

For Accessories, Cup holders & Configuration details, see Optima Home Theatre page attached.

Accessory Dock : \$35 ea.

Cup Holders: Metal: \$25 ea. | LED lighted Cup Holder: \$25 ea. | \*LED lighted Cup Holder with (1 or 2 motor) controls: \$40 ea.

\*LED Light strip under seat: \$25/seat.

| Description                      | L x D x H     | Leather |                       |  |  |                                  |                            | Fabric |          |           |
|----------------------------------|---------------|---------|-----------------------|--|--|----------------------------------|----------------------------|--------|----------|-----------|
|                                  |               | 10      | 20<br>Madras<br>Softy | 30<br>Hugo<br>Fantasy<br>Illusion<br>Tucson<br>Utah<br>Vintage<br>Wild Laredo<br>Yukon | 40<br>Elegance<br>Princess<br>Santiago<br>Sensation<br>Sunset<br>Trina<br>Victoria | 50<br>Bull<br>Cassiope<br>Dublin | 60<br>Caresse<br>Ultrasued | A      | B<br>COM | C<br>alta |
| 051 ARMLESS CHAIR                | 23,5x40x33/40 | 1085    | 1135                  | 1185   | 1235   | 1285                             | 1335                       | 845    | 900      | 955       |
| 052 SOFA LEFT ARM                | 82x40x33/40   | 2870    | 3005                  | 3140   | 3275   | 3410                             | 3545                       | 2290   | 2385     | 2480      |
| 053 SOFA RIGHT ARM               | 82x40x33/40   | 2870    | 3005                  | 3140   | 3275   | 3410                             | 3545                       | 2290   | 2385     | 2480      |
| 055 SQUARE CORNER                | 44x44x33/40   | 1915    | 2010                  | 2105   | 2200   | 2295                             | 2390                       | 1510   | 1565     | 1620      |
| 056 CHAIR RIGHT ARM              | 35x40x33/40   | 1510    | 1575                  | 1640   | 1705   | 1770                             | 1835                       | 1200   | 1260     | 1320      |
| 057 CHAIR LEFT ARM               | 35x40x33/40   | 1510    | 1575                  | 1640   | 1705   | 1770                             | 1835                       | 1200   | 1260     | 1320      |
| 061 LOVESEAT RIGHT ARM           | 58x40x33/40   | 2320    | 2420                  | 2520   | 2620   | 2720                             | 2820                       | 1850   | 1925     | 2000      |
| 071 ARMLESS RECLINING CHAIR      | 23,5x40x33/40 | 1470    | 1525                  | 1580   | 1635   | 1690                             | 1745                       | 1250   | 1310     | 1370      |
| 086 ARMLESS LOVESEAT BUMPER LEFT | 68x40x33/40   | 2245    | 2340                  | 2435   | 2530   | 2625                             | 2720                       | 1785   | 1850     | 1915      |
| 088 ARMLESS CHAIR BUMPER LEFT    | 45x40x33/40   | 1440    | 1535                  | 1630   | 1725   | 1820                             | 1915                       | 1130   | 1165     | 1200      |
| 089 ARMLESS CHAIR BUMPER RIGHT   | 45x40x33/40   | 1440    | 1535                  | 1630   | 1725   | 1820                             | 1915                       | 1130   | 1165     | 1200      |
| 095 APARTMENT SOFA               | 82x40x33/40   | 2940    | 3085                  | 3230   | 3375   | 3520                             | 3665                       | 2350   | 2445     | 2540      |
| 096 APARTMENT SOFA LEFT ARM      | 72x40x33/40   | 2570    | 2680                  | 2790   | 2900   | 3010                             | 3120                       | 2020   | 2110     | 2200      |
| 097 APARTMENT SOFA RIGHT ARM     | 72x40x33/40   | 2570    | 2680                  | 2790   | 2900   | 3010                             | 3120                       | 2020   | 2110     | 2200      |
| 124 STORAGE OTTOMAN              | 30x22x17      | 745     | 765                   | 785  | 805  | 825                              | 845                        | 650    | 670      | 690       |
| 138 STRAIGHT ARM                 | 10.5x36x22.5  | 415     | 450                   | 485  | 520  | 555                              | 590                        | 350    | 365      | 380       |

## SYDNEY

**FEATURES:**

- Manual adjustable headrest on all items (2 on square corner & stationary on wedge).
- \*Wall hugger power recliners with full footrest (manual n/a).
- Power recliner lounge chair (manual n/a) with power headrest in option. Wall clearance 8" & front 5".
- Seat cushions with shaped foam + 1" layer of memory foam on top; arm with memory foam.
- Stitching: Small thread in fabric & large flat thread in leather.

\*Excludes 043 & 163 chairs: Wall clearance 16"

Note: 2 recliner seats separated by a corner can not be opened at the same time. No recliner seats beside item #155.

**OPTIONS**

- Battery Pack: Add \$160/ea.
- \*Motorized headrest: Add \$160 ea. (\*N/A on stationary & lounge chair items).
- Foam: Extra firm add \$15/seat.
- Choice of Large or Small 6" Arm: Leg on LARGE arm: LG103 wood or LG189 metal (Black or Chrome). SMALL Arm: LG08 wood or LG196 metal (Black or Chrome). Specify colour.
- Seat Depth: 20" or \*22". \*22" seat depth N/A on chairs 043 & 163.
- 043 & 163 Chairs: with wood base (specify colour).

**HOME THEATRE Configurations**

For Accessories, Cup holders & Configuration details, see Optima Home Theatre page attached.

Accessory Dock : \$35 ea.

Cup Holders: Metal: \$25 ea. | LED lighted Cup Holder: \$25 ea. | \*LED lighted Cup Holder with (1 or 2 motor) controls: \$40 ea.

\*LED Light strip under seat: \$25/seat.

| Description                            | L x D x H     | Leather |                       |  |  |                                  |                           | Fabric |          |           |
|--|---------------|---------|-----------------------|--|--|----------------------------------|---------------------------|--------|----------|-----------|
|  |               | 10      | 20<br>Madras<br>Softy | 30<br>Hugo<br>Fantasy<br>Illusion<br>Tucson<br>Utah<br>Vintage<br>Wild Laredo<br>Yukon | 40<br>Elegance<br>Princess<br>Santiago<br>Sensation<br>Sunset<br>Trina<br>Victoria | 50<br>Bull<br>Cassiope<br>Dublin | 60<br>Caress<br>Ultrasued | A      | B<br>COM | C<br>alta |
| 155 SMALL SQUARE CORNER                | 40x40x33/40   | 1915    | 2010                  | 2105   | 2200   | 2295                             | 2390                      | 1510   | 1565     | 1620      |
| 159 WEDGE STORAGE                      | 12/27x36x22.5 | 745     | 775                   | 805  | 835  | 865                              | 895                       | 585    | 600      | 615       |
| 160 STRAIGHT STORAGE                   | 12x36x22.5    | 720     | 745                   | 770  | 795  | 820                              | 845                       | 550    | 570      | 590       |
| 163 DBL SWIVEL ROCKING RECLINER CHAIR  | 33x34x42      | 2290    | 2410                  | 2530   | 2650   | 2770                             | 2890                      | 1880   | 1930     | 1980      |
| 165 DOUBLE RECLINING CHAIR             | 52x40x33/40   | 2375    | 2475                  | 2575   | 2675   | 2775                             | 2875                      | 2000   | 2065     | 2130      |
| 167 APARTMENT SOFA NO ARM BUMPER LEFT  | 82x40x33/40   | 2490    | 2620                  | 2750   | 2880   | 3010                             | 3140                      | 1960   | 2045     | 2130      |
| 168 APARTMENT SOFA NO ARM BUMPER RIGHT | 82x40x33/40   | 2490    | 2620                  | 2750   | 2880   | 3010                             | 3140                      | 1960   | 2045     | 2130      |
| 169 DOUBLE RECLINING CHAIR LEFT ARM    | 42x40x33/40   | 1990    | 2070                  | 2150   | 2230   | 2310                             | 2390                      | 1670   | 1750     | 1830      |
| 170 DOUBLE RECLINING CHAIR RIGHT ARM   | 42x40x33/40   | 1990    | 2070                  | 2150   | 2230   | 2310                             | 2390                      | 1670   | 1750     | 1830      |
| 171 ARMLESS DOUBLE RECLINING CHAIR     | 30,5x40x33/40 | 1575    | 1625                  | 1675   | 1725   | 1775                             | 1825                      | 1320   | 1380     | 1440      |
| 173 DOUBLE LOUNGE CHAIR LEFT ARM       | 42x62x33/40   | 1915    | 2005                  | 2095   | 2185   | 2275                             | 2365                      | 1535   | 1615     | 1695      |
| 174 DOUBLE LOUNGE CHAIR RIGHT ARM      | 42x62x33/40   | 1915    | 2005                  | 2095   | 2185   | 2275                             | 2365                      | 1535   | 1615     | 1695      |
| 175 DOUBLE CHAIR LEFT ARM              | 42x40x33/40   | 1590    | 1680                  | 1770   | 1860   | 1950                             | 2040                      | 1285   | 1350     | 1415      |
| 176 DOUBLE CHAIR RIGHT ARM             | 42x40x33/40   | 1590    | 1680                  | 1770   | 1860   | 1950                             | 2040                      | 1285   | 1350     | 1415      |
| 177 ARMLESS DOUBLE CHAIR               | 30,5x40x33/40 | 1185    | 1250                  | 1315   | 1380   | 1445                             | 1510                      | 915    | 970      | 1025      |
| 178 ARMLESS DOUBLE CHAIR BUMPER LEFT   | 52x40x33/40   | 1545    | 1625                  | 1705   | 1785   | 1865                             | 1945                      | 1230   | 1290     | 1350      |

## SYDNEY

**FEATURES:**

- Manual adjustable headrest on all items (2 on square corner & stationary on wedge).
- \*Wall hugger power recliners with full footrest (manual n/a).
- Power recliner lounge chair (manual n/a) with power headrest in option. Wall clearance 8" & front 5".
- Seat cushions with shaped foam + 1" layer of memory foam on top; arm with memory foam.
- Stitching: Small thread in fabric & large flat thread in leather.
- \*Excludes 043 & 163 chairs: Wall clearance 16"

Note: 2 recliner seats separated by a corner can not be opened at the same time. No recliner seats beside item #155.

**OPTIONS**

- Battery Pack: Add \$160/ea.
- \*Motorized headrest: Add \$160 ea. (\*N/A on stationary & lounge chair items).
- Foam: Extra firm add \$15/seat.
- Choice of Large or Small 6" Arm: Leg on LARGE arm: LG103 wood or LG189 metal (Black or Chrome). SMALL Arm: LG08 wood or LG196 metal (Black or Chrome). Specify colour.
- Seat Depth: 20" or \*22". \*22" seat depth N/A on chairs 043 & 163.
- 043 & 163 Chairs: with wood base (specify colour).

**HOME THEATRE Configurations**

For Accessories, Cup holders & Configuration details, see Optima Home Theatre page attached.

Accessory Dock : \$35 ea.

Cup Holders: Metal: \$25 ea. | LED lighted Cup Holder: \$25 ea. | \*LED lighted Cup Holder with (1 or 2 motor) controls: \$40 ea.

\*LED Light strip under seat: \$25/seat.

| Description                            | L x D x H       | Leather |                       |  |  |                                  |                           | Fabric |          |           |
|--|-----------------|---------|-----------------------|--|--|----------------------------------|---------------------------|--------|----------|-----------|
|  |                 | 10      | 20<br>Madras<br>Softy | 30<br>Hugo<br>Fantasy<br>Illusion<br>Tucson<br>Utah<br>Vintage<br>Wild Laredo<br>Yukon | 40<br>Elegance<br>Princess<br>Santiago<br>Sensation<br>Sunset<br>Trina<br>Victoria | 50<br>Bull<br>Cassiope<br>Dublin | 60<br>Caress<br>Ultrasued | A      | B<br>COM | C<br>alta |
| 179 ARMLESS DOUBLE CHAIR BUMPER RIGHT  | 52x40x33/40     | 1545    | 1625                  | 1705   | 1785   | 1865                             | 1945                      | 1230   | 1290     | 1350      |
| 186 ARMLESS LOVESEAT BUMPER STORAGE-L  | 68x40x33/40     | 2420    | 2500                  | 2580   | 2660   | 2740                             | 2820                      | 1950   | 2015     | 2080      |
| 187 ARMLESS LOVESEAT BUMPER STORAGE-R  | 68x40x33/40     | 2420    | 2500                  | 2580   | 2660   | 2740                             | 2820                      | 1950   | 2015     | 2080      |
| 188 ARMLESS CHAIR BUMPER STORAGE-L     | 45x40x33/40     | 1600    | 1690                  | 1780   | 1870   | 1960                             | 2050                      | 1295   | 1330     | 1365      |
| 189 ARMLESS CHAIR BUMPER STORAGE-R     | 45x40x33/40     | 1600    | 1690                  | 1780   | 1870   | 1960                             | 2050                      | 1295   | 1330     | 1365      |
| 190 SMALL WEDGE STORAGE                | 12/21x36x22.5   | 720     | 745                   | 770  | 795  | 820                              | 845                       | 550    | 570      | 590       |
| 221 ARMLESS DBL CHAIR BUMPER STORAGE-L | 52x40x33/40     | 1705    | 1790                  | 1875   | 1960   | 2045                             | 2130                      | 1390   | 1450     | 1510      |
| 222 ARMLESS DBL CHAIR BUMPER STORAGE-R | 52x40x33/40     | 1705    | 1790                  | 1875   | 1960   | 2045                             | 2130                      | 1390   | 1450     | 1510      |
| 223 APT SOFA NO ARM BUMPER STORAGE-L   | 82x40x33/40     | 2655    | 2785                  | 2915   | 3045   | 3175                             | 3305                      | 2120   | 2215     | 2310      |
| 224 APT SOFA NO ARM BUMPER STORAGE-R   | 82x40x33/40     | 2655    | 2785                  | 2915   | 3045   | 3175                             | 3305                      | 2120   | 2215     | 2310      |
| 236 RECLINING LOUNGE CHAIR LEFT ARM    | 35x62x33/40     | 2160    | 2225                  | 2290   | 2355   | 2420                             | 2485                      | 1820   | 1880     | 1940      |
| 237 RECLINING LOUNGE CHAIR RIGHT ARM   | 35x62x33/40     | 2160    | 2225                  | 2290   | 2355   | 2420                             | 2485                      | 1820   | 1880     | 1940      |
| 238 RECLINING DBL LOUNGE CHAIR L-ARM   | 42x62x33/40     | 2315    | 2405                  | 2495   | 2585   | 2675                             | 2765                      | 1940   | 2020     | 2100      |
| 239 RECLINING DBL LOUNGE CHAIR R-ARM   | 42x62x33/40     | 2315    | 2405                  | 2495   | 2585   | 2675                             | 2765                      | 1940   | 2020     | 2100      |
| V51 WINE GLASS HOLDER                  | 3.5 x 5.5 x 6.5 | 35      | 35                    | 35   | 35   | 35                               | 35                        | 35     | 35       | 35        |
| V52 PLASTIC SWIVEL TRAY                | 13 3/8 x 9 5/8  | 35      | 35                    | 35   | 35   | 35                               | 35                        | 35     | 35       | 35        |

## SYDNEY

### FEATURES:

- Manual adjustable headrest on all items (2 on square corner & stationary on wedge).
- \*Wall hugger power recliners with full footrest (manual n/a).
- Power recliner lounge chair (manual n/a) with power headrest in option. Wall clearance 8" & front 5".
- Seat cushions with shaped foam + 1" layer of memory foam on top; arm with memory foam.
- Stitching: Small thread in fabric & large flat thread in leather.
- \*Excludes 043 & 163 chairs: Wall clearance 16"

Note: 2 recliner seats separated by a corner can not be opened at the same time. No recliner seats beside item #155.

### OPTIONS

- Battery Pack: Add \$160/ea.
- \*Motorized headrest: Add \$160 ea. (\*N/A on stationary & lounge chair items).
- Foam: Extra firm add \$15/seat.
- Choice of Large or Small 6" Arm: Leg on LARGE arm: LG103 wood or LG189 metal (Black or Chrome). SMALL Arm: LG08 wood or LG196 metal (Black or Chrome). Specify colour.
- Seat Depth: 20" or \*22". \*22" seat depth N/A on chairs 043 & 163.
- 043 & 163 Chairs: with wood base (specify colour).

### HOME THEATRE Configurations

For Accessories, Cup holders & Configuration details, see Optima Home Theatre page attached.

Accessory Dock : \$35 ea.

Cup Holders: Metal: \$25 ea. | LED lighted Cup Holder: \$25 ea. | \*LED lighted Cup Holder with (1 or 2 motor) controls: \$40 ea.

\*LED Light strip under seat: \$25/seat.

| Description                 | L x D x H          | Leather |                       |  |  |                                  |                           | Fabric |          |           |    |
|-----------------------------|--------------------|---------|-----------------------|--|--|----------------------------------|---------------------------|--------|----------|-----------|----|
|                             |                    | 10      | 20<br>Madras<br>Softy | 30<br>Hugo<br>Fantasy<br>Illusion<br>Tucson<br>Utah<br>Vintage<br>Wild Laredo<br>Yukon | 40<br>Elegance<br>Princess<br>Santiago<br>Sensation<br>Sunset<br>Trina<br>Victoria | 50<br>Bull<br>Cassiope<br>Dublin | 60<br>Caress<br>Ultrasued | A      | B<br>COM | C<br>alta |    |
| V53 WOOD SWIVEL TRAY        | 19 x 10            | 60      | 60                    | 60   | 60   | 60                               | 60                        | 60     | 60       | 60        | 60 |
| V54 TABLET HOLDER           | 4.5 x 8 x 10       | 40      | 40                    | 40   | 40   | 40                               | 40                        | 40     | 40       | 40        | 40 |
| V55 LED LAMP                | 1.5x5x14 plié/bent | 35      | 35                    | 35   | 35   | 35                               | 35                        | 35     | 35       | 35        | 35 |
| <b>CONFIGURATIONS</b>       |                    |         |                       |  |  |                                  |                           |        |          |           |    |
| _A CONFIG (169-170)         | 84X40X40           | 3980    | 4140                  | 4300   | 4460   | 4620                             | 4780                      | 3340   | 3500     | 3660      |    |
| _B CONFIG (169-171-174)     | 115X62X40          | 5480    | 5700                  | 5920   | 6140   | 6360                             | 6580                      | 4525   | 4745     | 4965      |    |
| _C CONFIG (096-055-171-170) | 116X116X40         | 8050    | 8385                  | 8720   | 9055   | 9390                             | 9725                      | 6520   | 6805     | 7090      |    |
| _D CONFIG (169-171-055-179) | 116X96X40          | 7025    | 7330                  | 7635   | 7940   | 8245                             | 8550                      | 5730   | 5985     | 6240      |    |
| _J CONFIG (041-042)         | 70X40X40           | 3770    | 3920                  | 4070   | 4220   | 4370                             | 4520                      | 3210   | 3280     | 3350      |    |
| _K CONFIG (041-071-005)     | 94X62X40           | 5120    | 5315                  | 5510   | 5705   | 5900                             | 6095                      | 4265   | 4420     | 4575      |    |
| _L CONFIG (012-055-071-042) | 102X102X40         | 7590    | 7915                  | 8240   | 8565   | 8890                             | 9215                      | 6215   | 6440     | 6665      |    |
| _M CONFIG (041-071-055-089) | 103X89X40          | 6710    | 7030                  | 7350   | 7670   | 7990                             | 8310                      | 5495   | 5680     | 5865      |    |



# SYDNEY

**OPTIMA**  
Collection

**Jaymar**

Conçu et fabriqué fièrement au Canada  
Proudly designed and made in Canada

Nos produits sont fabriqués à la main et des variations mineures peuvent survenir.

Our product is hand-made and minor variations can occur.

## SPECIFICATIONS

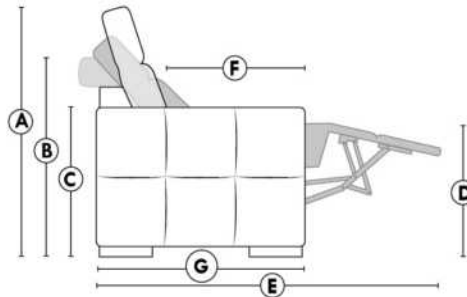

- Appui-tête levé / Headrest up
- Appui-tête baissé / Headrest down
- Complètement incliné / Fully reclined

- A** Hauteur complète 40" / Total Height
- B** Hauteur appui-tête baissé 33" / Height headrest down
- C** Hauteur du bras 22,5" / Arm Height
- D** Hauteur du siège 19,5" / Seat height
- E** Profondeur inclinée 65" / Depth fully reclined
- F** Profondeur d'assise 20" ou/ou 22" / Seat depth
- G** Profondeur appui-tête monté 37,5" / Depth with headrest up

## BRAS | ARMS

Option de bras:  
Bras Régulier Large 10,5" ou Petit bras 6"

Arm option  
Regular arm Large 10,5" or Small arm 6"

Contrôle de l'inclinaison situé à l'intérieur du bras  
Recliner control located on the inside of the arm.

Option d'accessoires disponible sur le bras régulier seulement  
Accessories option, available on Regular arms ONLY.

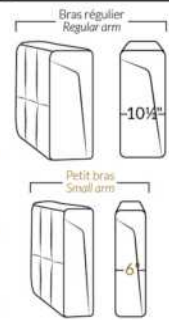

## FAUTEUIL BERÇANT PIVOTANT INCLINABLE SWIVEL ROCKING MOTION CHAIR



## SIÈGE 23" DE LARGE | 23" SEAT WIDTH

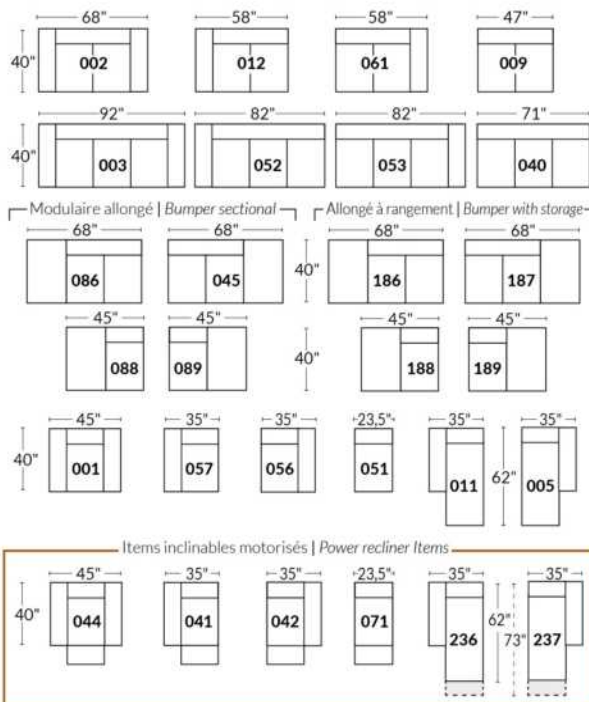

## SIÈGE 30" DE LARGE | 30" SEAT WIDTH

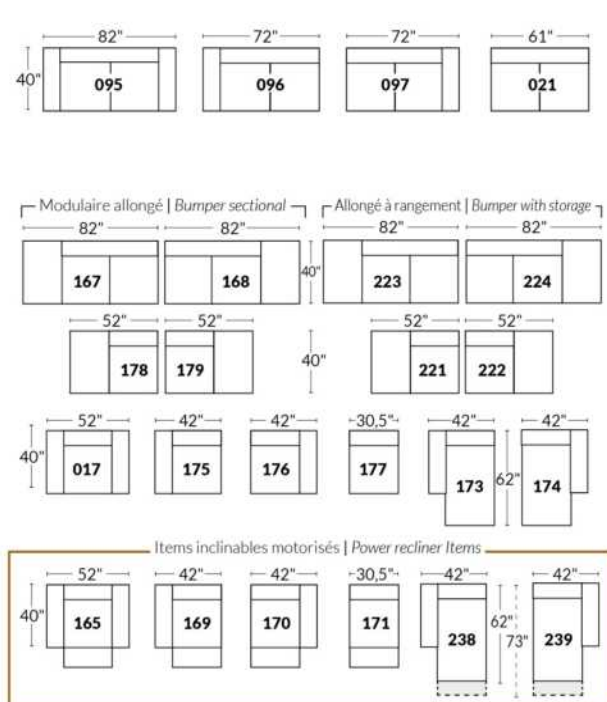

### Autres | Others

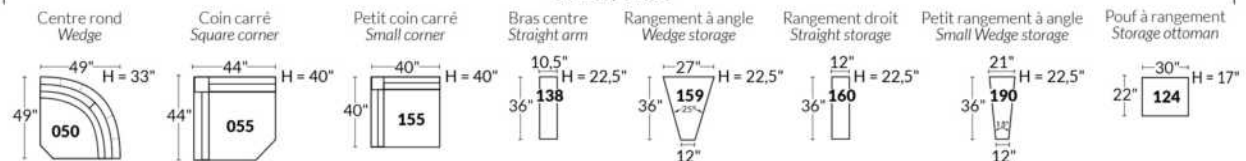

### EXEMPLE 23" EXAMPLE

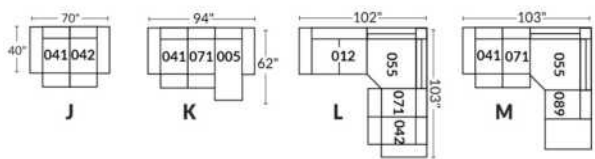

### EXEMPLE 30" EXAMPLE

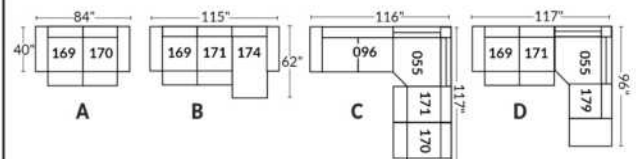

\*Available on certain models and on large arms ONLY.

### OPTIONS CUP HOLDERS

#### METAL



Silver



Matte Black



Brown

#### ILLUMINATED

1.



LED Lighted Cup holder

2.



LED Lighted Cup holder with Single Motor Control, USB Port and LED Base rail

3.



LED Lighted Cup holder with Dual Motor Control, USB Port and LED Base rail

Our illuminated one or two-control cup holders are compatible with LED lights under the seat. You can control the light on the cup holder. The 2 motor cup holder has a reset (home) button control to close your recliner back to its starting position.

#### LED Light under seat (Optional)

Available only in configurations with a minimum of 1 illuminated motorized cup holder with control buttons. The "light" button will control the opening and closing of the light.

For cup holder prices see description section of the Optima model price list.

Please provide us with a drawing of your configuration which indicates the cup holder type and its positioning.

#### Cup holder with controller:

It is important to specify the placement of the cups; on left arm or right arm and which recliner they will control. If you have a row of several seats with cup holders, by default, the controls will be on the left arms and on the right arm for the last outer chair.

#### EXAMPLE A:

041-169: Controller and cup holder on the left arm

071-171: hidden touch sensor buttons on side of seat

042-170: Controller and cup holder on right arm

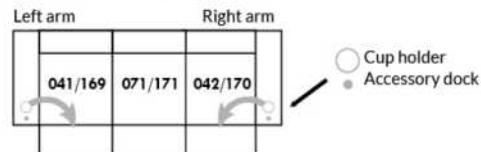

#### EXAMPLE B:

071-171: These two items can be connected to a smart cup holder which will control the recliner. You must then use one of these items: 138,159, 160 and 190

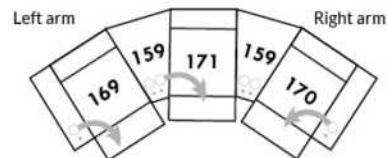

#### Informations about headrest, controller on reclining seat

#### WITH illuminated cup holder

If you have a **stationary item**, you will have cup holder N°1.

If you have a recliner chair with a **manual headrest**, you will have the cup holder N°2.

If you have a recliner chair with an **electric headrest**, you will have cup holder N°3.

#### Without cup holder and with a reclining seat

If you have a recliner with a **manual headrest** you will have the touch sensor button control on the side of the seat.

If you have a recliner with an **electric headrest** you will have a dual push button controller with USB port on the arm.

If you have an **armless recliner**, you will have the hidden touch sensor button control.



Hidden touch sensor



Dual push button



# OPTIMA

## HOME THEATRE Configurations

\*Available on certain models and on large arms ONLY.

OPTIONS

### ACCESSORIES

Accessory Dock



V51 Wine Glass Holder



V52 Plastic Swivel Tray Table



V53 Wood Swivel tray Table  
(Choice of 8 colors)



Specify on which arm (left or right) the tray table will be installed.

V54 Tablet Holder



V55 LED Lamp



(For Accessory Dock price, see description section of the Optima model price list and for Accessory item prices, see at very end of the price list)

### Items 138-159-160-190 and large arm.

Accessory docks and cups are Optional. \*Not available on small arms\*

Please specify on which arms you want the accessory docks and cup holders.

NB: Item 138-159-160-190 are unfinished on the sides, must be used between 2 seats.

Each storage item has 2 USB ports and one electrical outlet inside the storage.



### SUGGESTED CONFIGURATIONS





## CDN Price List

### TALBOT

LEGS: LG60 metal or LG302 wood. If wood, specify leg colour.  
COMBO AVAILABLE: Cover #1 base and arm. / Cover #2 back and seat.

| Description                  | L x D x H    | Leather |                       |  |  |                                  |                           | Fabric |          |           |
|------------------------------|--------------|---------|-----------------------|--|--|----------------------------------|---------------------------|--------|----------|-----------|
|                              |              | 10      | 20<br>Madras<br>Softy | 30<br>Hugo<br>Fantasy<br>Illusion<br>Tucson<br>Utah<br>Vintage<br>Wild Laredo<br>Yukon | 40<br>Elegance<br>Princess<br>Santiago<br>Sensation<br>Sunset<br>Trina<br>Victoria | 50<br>Bull<br>Cassiope<br>Dublin | 60<br>Caress<br>Ultrasued | A      | B<br>COM | C<br>alta |
| 001 CHAIR                    | 33X36X35     | 1470    | 1550                  | 1630   | 1710   | 1790                             | 1870                      | 1045   | 1100     | 1155      |
| 002 LOVESEAT                 | 58X36X35     | 2025    | 2135                  | 2245   | 2355   | 2465                             | 2575                      | 1485   | 1560     | 1635      |
| 005 LOUNGE CHAIR RIGHT ARM   | 29X60X35     | 1460    | 1550                  | 1640   | 1730   | 1820                             | 1910                      | 1085   | 1145     | 1205      |
| 006 OTTOMAN                  | 25.5X25.5X18 | 685     | 710                   | 735  | 760  | 785                              | 810                       | 550    | 570      | 590       |
| 010 LOUNGE CHAIR             | 33X60X35     | 1735    | 1825                  | 1915   | 2005   | 2095                             | 2185                      | 1180   | 1265     | 1350      |
| 011 LOUNGE CHAIR LEFT ARM    | 29X60X35     | 1460    | 1550                  | 1640   | 1730   | 1820                             | 1910                      | 1085   | 1145     | 1205      |
| 012 LOVESEAT LEFT ARM        | 54X36X35     | 1755    | 1850                  | 1945   | 2040   | 2135                             | 2230                      | 1395   | 1475     | 1555      |
| 050 WEDGE                    | 48X48X35     | 1470    | 1565                  | 1660   | 1755   | 1850                             | 1945                      | 1095   | 1140     | 1185      |
| 051 ARMLESS CHAIR            | 25X36X35     | 990     | 1070                  | 1150   | 1230   | 1310                             | 1390                      | 890    | 940      | 990       |
| 055 SQUARE CORNER            | 36X36X35     | 1415    | 1500                  | 1585   | 1670   | 1755                             | 1840                      | 1030   | 1085     | 1140      |
| 056 CHAIR RIGHT ARM          | 40X36X35     | 1275    | 1340                  | 1405   | 1470   | 1535                             | 1600                      | 995    | 1040     | 1085      |
| 057 CHAIR LEFT ARM           | 40X36X35     | 1275    | 1340                  | 1405   | 1470   | 1535                             | 1600                      | 995    | 1040     | 1085      |
| 061 LOVESEAT RIGHT ARM       | 54X36X35     | 1755    | 1850                  | 1945   | 2040   | 2135                             | 2230                      | 1395   | 1475     | 1555      |
| 072 SECTIONAL SOFA LEFT ARM  | 90X36X35     | 2750    | 2900                  | 3050   | 3200   | 3350                             | 3500                      | 1750   | 1825     | 1900      |
| 073 SECTIONAL SOFA RIGHT ARM | 90X36X35     | 2750    | 2900                  | 3050   | 3200   | 3350                             | 3500                      | 1750   | 1825     | 1900      |
| 095 APARTMENT SOFA           | 80X36X35     | 2495    | 2645                  | 2795   | 2945   | 3095                             | 3245                      | 1580   | 1655     | 1730      |
| 096 APARTMENT SOFA LEFT ARM  | 76X36X35     | 2240    | 2390                  | 2540   | 2690   | 2840                             | 2990                      | 1525   | 1610     | 1695      |
| 097 APARTMENT SOFA RIGHT ARM | 76X36X35     | 2240    | 2390                  | 2540   | 2690   | 2840                             | 2990                      | 1525   | 1610     | 1695      |
| <b>CONFIGURATIONS</b>        |              |         |                       |  |  |                                  |                           |        |          |           |
| A CONF. A (096-050-051-005)  | 124X102X35   | 6160    | 6575                  | 6990   | 7405   | 7820                             | 8235                      | 4595   | 4835     | 5075      |
| B CONF. B (012-073)          | 90X90X35     | 4505    | 4750                  | 4995   | 5240   | 5485                             | 5730                      | 3145   | 3300     | 3455      |
| C CONF. C (072-051-005)      | 90X90X35     | 5200    | 5520                  | 5840   | 6160   | 6480                             | 6800                      | 3725   | 3910     | 4095      |
| D CONF. D (073-057)          | 76X90X35     | 4025    | 4240                  | 4455   | 4670   | 4885                             | 5100                      | 2745   | 2865     | 2985      |
| E CONF. E (057-050-097)      | 124X88X35    | 4985    | 5295                  | 5605   | 5915   | 6225                             | 6535                      | 3615   | 3790     | 3965      |
| F CONF. F (012-005)          | 83X60X35     | 3215    | 3400                  | 3585   | 3770   | 3955                             | 4140                      | 2480   | 2620     | 2760      |

# TALBOT



Hauteur complète 35" | Hauteur de siège 19" | Hauteur devant bras 24" | Profondeur d'assise 21"  
 Total Height 35" | Seat Height 19" | Arm Height 24" | Seat Depth 21"

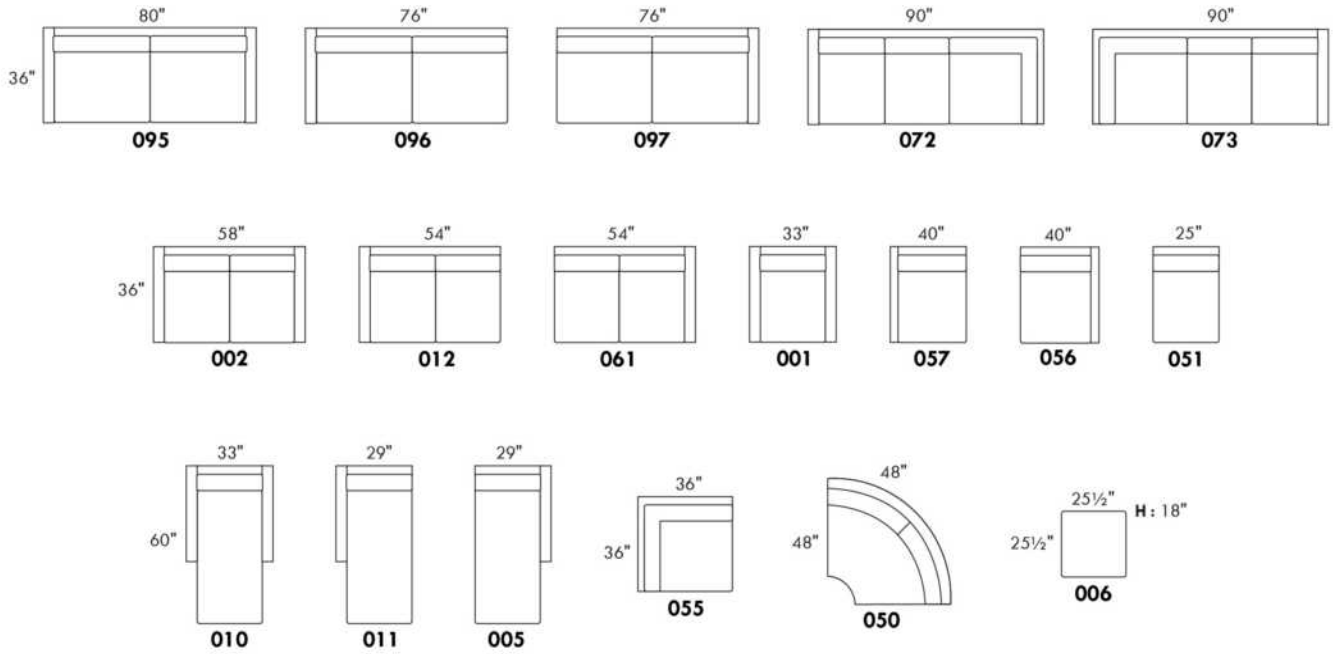

## CONFIGURATIONS

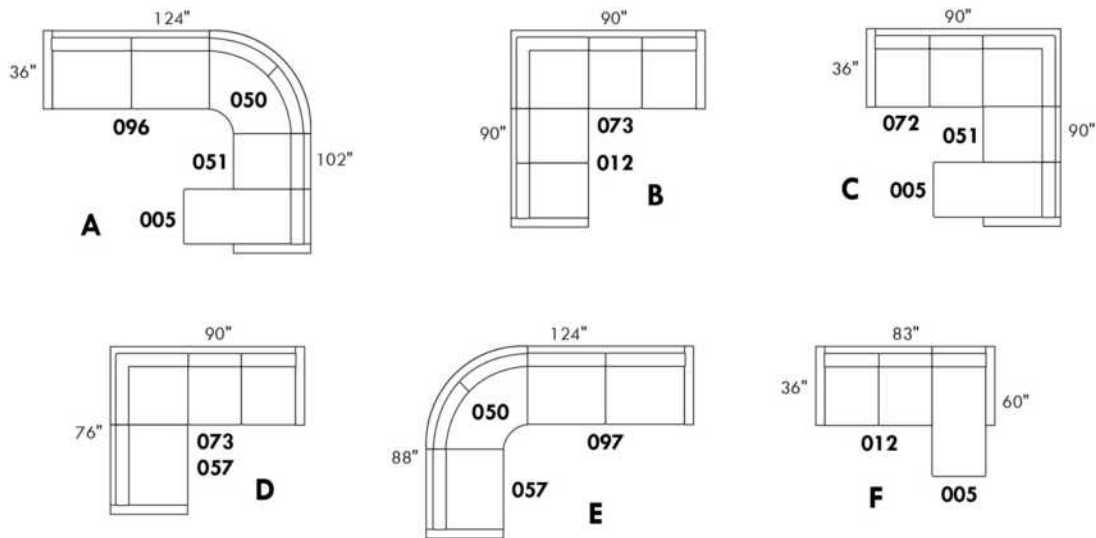

www.jaymar.ca

Toutes les dimensions indiquées sont au pouce près. Nos produits sont fabriqués à la main et des variations mineures peuvent survenir.  
 All dimensions indicated are to the nearest inch. Our product is hand-made and minor variations can occur.

## CDN Price List

### TAURUS

LG73 metal. Also available LG72 wood only, specify wood finish for LG72.

COMBO: Cover #2 on BACKS only.

OPTIONAL LEATHER PATCH ON TOP OF ARM:

FABRIC: Leather patch: Upcharge of \$50 per arm.

COMBO FABRIC & LEATHER: Leather patch no upcharge.

\*REMARK: In leather, armless end pieces are not fully upholstered.

| Description                | L x D x H | Leather |                       |  |  |                                  |                           | Fabric |          |           |
|----------------------------|-----------|---------|-----------------------|--|--|----------------------------------|---------------------------|--------|----------|-----------|
|                            |           | 10      | 20<br>Madras<br>Softy | 30<br>Hugo<br>Fantasy<br>Illusion<br>Tucson<br>Utah<br>Vintage<br>Wild Laredo<br>Yukon | 40<br>Elegance<br>Princess<br>Santiago<br>Sensation<br>Sunset<br>Trina<br>Victoria | 50<br>Bull<br>Cassiope<br>Dublin | 60<br>Caress<br>Ultrasued | A      | B<br>COM | C<br>alta |
| 001 CHAIR                  | 38X40X36  | 1600    | 1665                  | 1730   | 1795   | 1860                             | 1925                      | 1200   | 1250     | 1300      |
| 002 LOVESEAT               | 66X40X36  | 2330    | 2425                  | 2520   | 2615   | 2710                             | 2805                      | 1740   | 1795     | 1850      |
| 003 SOFA                   | 94X40X36  | 2815    | 2930                  | 3045   | 3160   | 3275                             | 3390                      | 2175   | 2235     | 2295      |
| 005 LOUNGE CHAIR RIGHT ARM | 34X64X36  | 1560    | 1675                  | 1790   | 1905   | 2020                             | 2135                      | 1040   | 1120     | 1200      |
| 006 OTTOMAN                | 40X25X18  | 685     | 710                   | 735  | 760  | 785                              | 810                       | 550    | 570      | 590       |
| 009 ARMLESS LOVESEAT       | 56X40X36  | 1945    | 2035                  | 2125   | 2215   | 2305                             | 2395                      | 1395   | 1470     | 1545      |
| 010 LOUNGE CHAIR           | 38X64X36  | 1750    | 1865                  | 1980   | 2095   | 2210                             | 2325                      | 1210   | 1305     | 1400      |
| 011 LOUNGE CHAIR LEFT ARM  | 34X64X36  | 1560    | 1675                  | 1790   | 1905   | 2020                             | 2135                      | 1040   | 1120     | 1200      |
| 012 LOVESEAT LEFT ARM      | 61X40X36  | 2140    | 2230                  | 2320   | 2410   | 2500                             | 2590                      | 1575   | 1625     | 1675      |
| 040 ARMLESS SOFA           | 84X40X36  | 2425    | 2525                  | 2625   | 2725   | 2825                             | 2925                      | 1905   | 1980     | 2055      |
| 051 ARMLESS CHAIR          | 28X40X36  | 1185    | 1230                  | 1275   | 1320   | 1365                             | 1410                      | 905    | 940      | 975       |
| 052 SOFA LEFT ARM          | 89X40X36  | 2615    | 2725                  | 2835   | 2945   | 3055                             | 3165                      | 2020   | 2090     | 2160      |
| 053 SOFA RIGHT ARM         | 89X40X36  | 2615    | 2725                  | 2835   | 2945   | 3055                             | 3165                      | 2020   | 2090     | 2160      |
| 056 CHAIR RIGHT ARM        | 33X40X36  | 1400    | 1465                  | 1530   | 1595   | 1660                             | 1725                      | 1045   | 1095     | 1145      |
| 057 CHAIR LEFT ARM         | 33X40X36  | 1400    | 1465                  | 1530   | 1595   | 1660                             | 1725                      | 1045   | 1095     | 1145      |
| 061 LOVESEAT RIGHT ARM     | 61X40X36  | 2140    | 2230                  | 2320   | 2410   | 2500                             | 2590                      | 1575   | 1625     | 1675      |
| 076 ROUND CHAIR LEFT       | 42X50X36  | 1585    | 1645                  | 1705   | 1765   | 1825                             | 1885                      | 1200   | 1255     | 1310      |
| 081 ROUND CHAIR RIGHT      | 42X50X36  | 1585    | 1645                  | 1705   | 1765   | 1825                             | 1885                      | 1200   | 1255     | 1310      |
| <b>CONFIGURATIONS</b>      |           |         |                       |  |  |                                  |                           |        |          |           |
| A CONF. A (076-009-081)    | 140X50X36 | 5115    | 5325                  | 5535   | 5745   | 5955                             | 6165                      | 3795   | 3980     | 4165      |
| B CONF. B (076-040-081)    | 168X50X36 | 5595    | 5815                  | 6035   | 6255   | 6475                             | 6695                      | 4305   | 4490     | 4675      |
| C CONF. C (076-009)        | 98X50X36  | 3530    | 3680                  | 3830   | 3980   | 4130                             | 4280                      | 2595   | 2725     | 2855      |
| D CONF. D (009-081)        | 98X50X36  | 3530    | 3680                  | 3830   | 3980   | 4130                             | 4280                      | 2595   | 2725     | 2855      |
| E CONF. E (012-005)        | 94X64X36  | 3700    | 3905                  | 4110   | 4315   | 4520                             | 4725                      | 2615   | 2745     | 2875      |
| F CONF. F (076-040)        | 126X50X36 | 4010    | 4170                  | 4330   | 4490   | 4650                             | 4810                      | 3105   | 3235     | 3365      |

## CDN Price List

### TAURUS

| Description             | L x D x H | Leather |                       |  |  |                                  |                           | Fabric |          |           |
|-------------------------|-----------|---------|-----------------------|--|--|----------------------------------|---------------------------|--------|----------|-----------|
|                         |           | 10      | 20<br>Madras<br>Softy | 30<br>Hugo<br>Fantasy<br>Illusion<br>Tucson<br>Utah<br>Vintage<br>Wild Laredo<br>Yukon | 40<br>Elegance<br>Princess<br>Santiago<br>Sensation<br>Sunset<br>Trina<br>Victoria | 50<br>Bull<br>Cassiope<br>Dublin | 60<br>Caress<br>Ultrasued | A      | B<br>COM | C<br>alta |
| G CONF. G (040-081)     | 126X50X36 | 4010    | 4170                  | 4330   | 4490   | 4650                             | 4810                      | 3105   | 3235     | 3365      |
| H CONF. H (052-005)     | 122X64X36 | 4175    | 4400                  | 4625   | 4850   | 5075                             | 5300                      | 3060   | 3210     | 3360      |
| I CONF. I (076-040-005) | 159X64X36 | 5570    | 5845                  | 6120   | 6395   | 6670                             | 6945                      | 4145   | 4355     | 4565      |
| J CONF. J (076-009-005) | 131X64X36 | 5090    | 5355                  | 5620   | 5885   | 6150                             | 6415                      | 3635   | 3845     | 4055      |

# TAURUS



Hauteur complète 36" | Hauteur de siège 18" | Hauteur devant bras 27" | Profondeur d'assise 21"  
 Total Height 36" | Seat Height 18" | Arm Height 27" | Seat Depth 21"

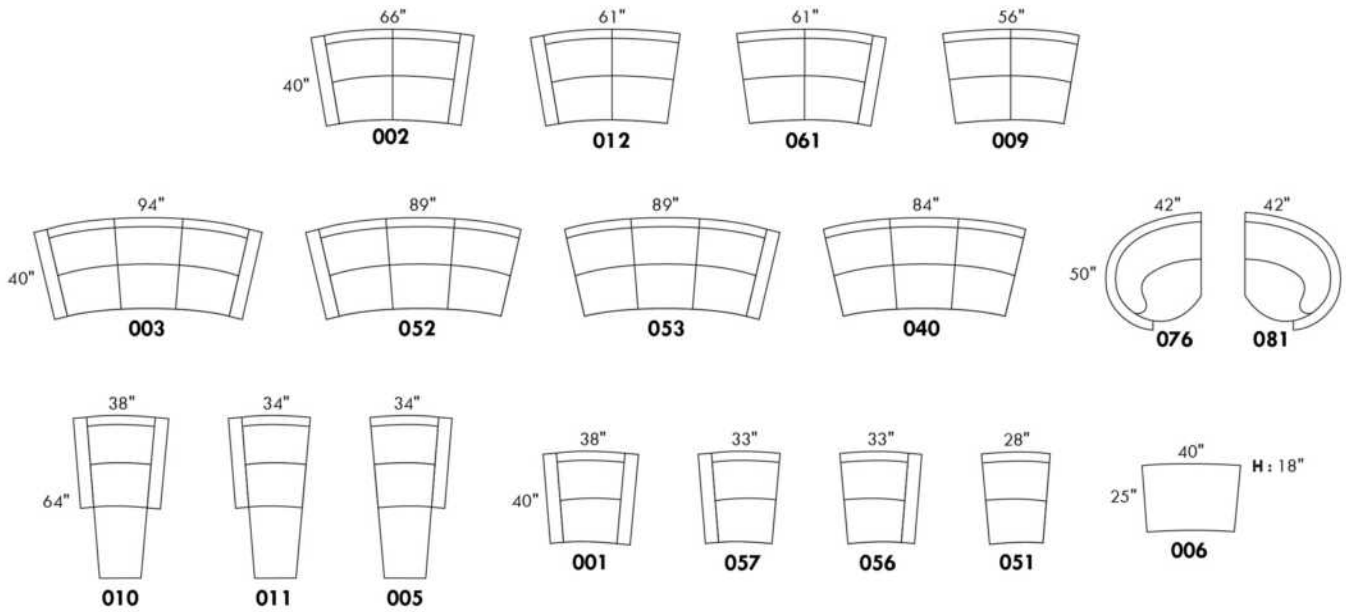

## CONFIGURATIONS

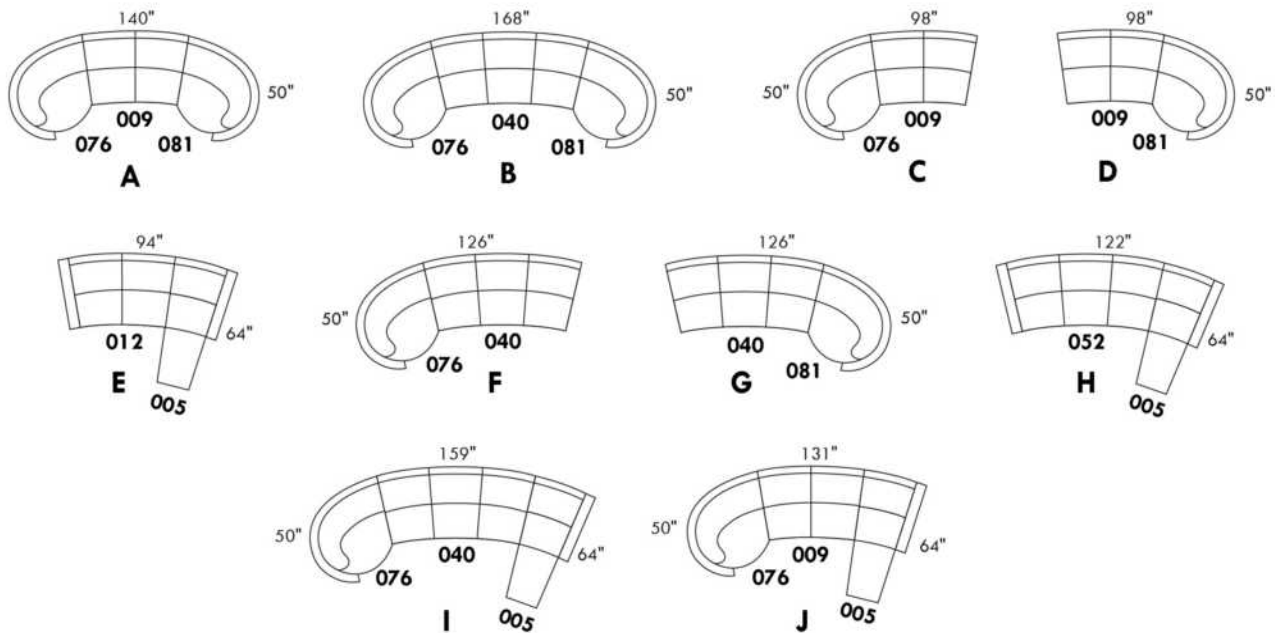

www.jaymar.ca

Toutes les dimensions indiquées sont au pouce près. Nos produits sont fabriqués à la main et des variations mineures peuvent survenir.  
 All dimensions indicated are to the nearest inch. Our product is hand-made and minor variations can occur.



## TODD

FEATURES: Upholstered seat cushions with high quality 2.5 lb. density shaped foam and a 1" layer of memory foam.

LEG: Specify colour of legs LG04.

In fabric, stitching will be with a thinner thread. PLAIN FABRIC RECOMMENDED.

IN LEATHER available with CONTRASTING THREAD: Upcharge of \$50/piece. Specify thread number: 005-Black, 087-Beige, 103-Brown, 111-White.

Sofa bed: Slat support system with 2" mattress included.

| Description                   | L x D x H | Leather |                       |  |  |                                  |                           | Fabric |          |           |
|-------------------------------|-----------|---------|-----------------------|--|--|----------------------------------|---------------------------|--------|----------|-----------|
|                               |           | 10      | 20<br>Madras<br>Softy | 30<br>Hugo<br>Fantasy<br>Illusion<br>Tucson<br>Utah<br>Vintage<br>Wild Laredo<br>Yukon | 40<br>Elegance<br>Princess<br>Santiago<br>Sensation<br>Sunset<br>Trina<br>Victoria | 50<br>Bull<br>Cassiope<br>Dublin | 60<br>Caress<br>Ultrasued | A      | B<br>COM | C<br>alta |
| 001 CHAIR                     | 33X35X33  | 1510    | 1590                  | 1670   | 1750   | 1830                             | 1910                      | 1130   | 1165     | 1200      |
| 002 LOVESEAT                  | 54X35X33  | 2055    | 2165                  | 2275   | 2385   | 2495                             | 2605                      | 1480   | 1560     | 1640      |
| 003 SOFA                      | 75X35X33  | 2420    | 2575                  | 2730   | 2885   | 3040                             | 3195                      | 1770   | 1855     | 1940      |
| 004 DOUBLE SOFA BED           | 75X35X33  | 2805    | 2940                  | 3075   | 3210   | 3345                             | 3480                      | 2185   | 2275     | 2365      |
| 005 LOUNGE CHAIR RIGHT ARM    | 27X59X33  | 1770    | 1880                  | 1990   | 2100   | 2210                             | 2320                      | 1210   | 1295     | 1380      |
| 006 OTTOMAN                   | 22X22X17  | 620     | 680                   | 740  | 800  | 860                              | 920                       | 535    | 545      | 555       |
| 009 ARMLESS LOVESEAT          | 42X35X33  | 1670    | 1785                  | 1900   | 2015   | 2130                             | 2245                      | 1285   | 1350     | 1415      |
| 011 LOUNGE CHAIR LEFT ARM     | 27X59X33  | 1770    | 1880                  | 1990   | 2100   | 2210                             | 2320                      | 1210   | 1295     | 1380      |
| 012 LOVESEAT LEFT ARM         | 48X35X33  | 1855    | 1975                  | 2095   | 2215   | 2335                             | 2455                      | 1360   | 1435     | 1510      |
| 040 ARMLESS SOFA              | 63X35X33  | 2025    | 2170                  | 2315   | 2460   | 2605                             | 2750                      | 1545   | 1645     | 1745      |
| 049 DOUBLE SOFA BED LEFT ARM  | 69X35X33  | 2610    | 2770                  | 2930   | 3090   | 3250                             | 3410                      | 2085   | 2180     | 2275      |
| 052 SOFA LEFT ARM             | 69X35X33  | 2200    | 2350                  | 2500   | 2650   | 2800                             | 2950                      | 1655   | 1750     | 1845      |
| 053 SOFA RIGHT ARM            | 69X35X33  | 2200    | 2350                  | 2500   | 2650   | 2800                             | 2950                      | 1655   | 1750     | 1845      |
| 055 SQUARE CORNER             | 35X35X33  | 1460    | 1565                  | 1670   | 1775   | 1880                             | 1985                      | 1130   | 1175     | 1220      |
| 058 DOUBLE SOFA BED NO ARM    | 63X35X33  | 2440    | 2595                  | 2750   | 2905   | 3060                             | 3215                      | 1980   | 2070     | 2160      |
| 059 DOUBLE SOFA BED RIGHT ARM | 69X35X33  | 2610    | 2770                  | 2930   | 3090   | 3250                             | 3410                      | 2085   | 2180     | 2275      |
| 061 LOVESEAT RIGHT ARM        | 48X35X33  | 1855    | 1975                  | 2095   | 2215   | 2335                             | 2455                      | 1360   | 1435     | 1510      |
| 095 APARTMENT SOFA            | 68X35X33  | 2300    | 2430                  | 2560   | 2690   | 2820                             | 2950                      | 1660   | 1750     | 1840      |

Hauteur complète 33" | Hauteur de siège 18½" | Profondeur d'assise 21"  
 Total Height 33" | Seat Height 18½" | Seat Depth 21"

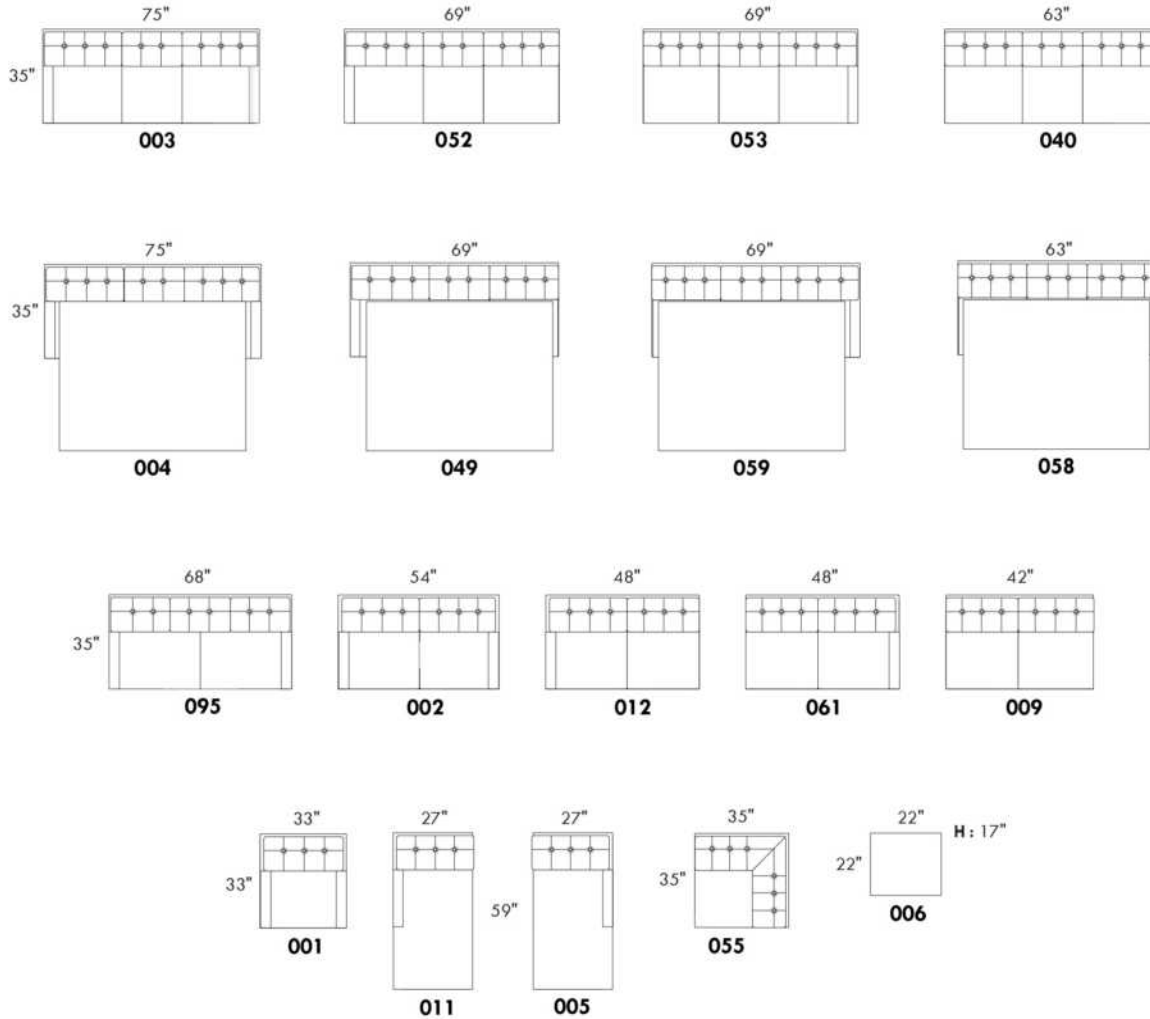

## CDN Price List

### TOULOUSE

FEATURES: Modern style with tufted headrest & base. Manual headrest adjustable to 1 position.  
SPECS: Seat Depth: 23". Arm Height: 21". Seat Height: 16,5".

LEG: LG103 wood (specify colour).

ITEMS #194 & #195 Double Angle Chair: Specify colour of wood insert.

| Description                       | L x D x H     | Leather |                       |  |  |                                  |                           | Fabric |          |           |
|-----------------------------------|---------------|---------|-----------------------|--|--|----------------------------------|---------------------------|--------|----------|-----------|
|                                   |               | 10      | 20<br>Madras<br>Softy | 30<br>Hugo<br>Fantasy<br>Illusion<br>Tucson<br>Utah<br>Vintage<br>Wild Laredo<br>Yukon | 40<br>Elegance<br>Princess<br>Santiago<br>Sensation<br>Sunset<br>Trina<br>Victoria | 50<br>Bull<br>Cassiope<br>Dublin | 60<br>Caress<br>Ultrasued | A      | B<br>COM | C<br>alta |
| 006 OTTOMAN                       | 32x24x16      | 765     | 845                   | 925  | 1005   | 1085                             | 1165                      | 650    | 665      | 680       |
| 017 DOUBLE CHAIR                  | 58x40x28/35   | 1800    | 1955                  | 2110   | 2265   | 2420                             | 2575                      | 1355   | 1420     | 1485      |
| 021 APARTMENT SOFA NO ARM         | 64x40x28/35   | 2465    | 2600                  | 2735   | 2870   | 3005                             | 3140                      | 2010   | 2090     | 2170      |
| 050 WEDGE                         | 49x49x21      | 1700    | 1815                  | 1930   | 2045   | 2160                             | 2275                      | 1365   | 1425     | 1485      |
| 095 APARTMENT SOFA                | 89x40x28/35   | 3040    | 3260                  | 3480   | 3700   | 3920                             | 4140                      | 2355   | 2450     | 2545      |
| 096 APARTMENT SOFA LEFT ARM       | 76x40x28/35   | 2750    | 2930                  | 3110   | 3290   | 3470                             | 3650                      | 2185   | 2270     | 2355      |
| 097 APARTMENT SOFA RIGHT ARM      | 76x40x28/35   | 2750    | 2930                  | 3110   | 3290   | 3470                             | 3650                      | 2185   | 2270     | 2355      |
| 173 DOUBLE LOUNGE CHAIR LEFT ARM  | 45x64x28/35   | 2375    | 2565                  | 2755   | 2945   | 3135                             | 3325                      | 1840   | 1940     | 2040      |
| 174 DOUBLE LOUNGE CHAIR RIGHT ARM | 45x64x28/35   | 2375    | 2565                  | 2755   | 2945   | 3135                             | 3325                      | 1840   | 1940     | 2040      |
| 175 DOUBLE CHAIR LEFT ARM         | 45x40x28/35   | 1520    | 1625                  | 1730   | 1835   | 1940                             | 2045                      | 1175   | 1250     | 1325      |
| 176 DOUBLE CHAIR RIGHT ARM        | 45x40x28/35   | 1520    | 1625                  | 1730   | 1835   | 1940                             | 2045                      | 1175   | 1250     | 1325      |
| 177 ARMLESS DOUBLE CHAIR          | 32x40x28/35   | 1240    | 1300                  | 1360   | 1420   | 1480                             | 1540                      | 1005   | 1065     | 1125      |
| 194 DBL ANGLE CHAIR L-ARM         | 74x40x28/35   | 1795    | 1930                  | 2065   | 2200   | 2335                             | 2470                      | 1460   | 1545     | 1630      |
| 195 DBL ANGLE CHAIR R-ARM         | 74x40x28/35   | 1795    | 1930                  | 2065   | 2200   | 2335                             | 2470                      | 1460   | 1545     | 1630      |
| <b>CONFIGURATIONS</b>             |               |         |                       |  |  |                                  |                           |        |          |           |
| A CONFIG (175-177-176)            | 122X40X28/35  | 4280    | 4550                  | 4820   | 5090   | 5360                             | 5630                      | 3355   | 3565     | 3775      |
| B CONFIG (194-097)                | 136X72X28/35  | 4545    | 4860                  | 5175   | 5490   | 5805                             | 6120                      | 3645   | 3815     | 3985      |
| C CONFIG (096-174)                | 121X64X28/35  | 5125    | 5495                  | 5865   | 6235   | 6605                             | 6975                      | 4025   | 4210     | 4395      |
| D CONFIG (173-021-195)            | 169X72X28/35  | 6635    | 7095                  | 7555   | 8015   | 8475                             | 8935                      | 5310   | 5575     | 5840      |
| E CONFIG (096-050-097)            | 125X125X28/35 | 7200    | 7675                  | 8150   | 8625   | 9100                             | 9575                      | 5735   | 5965     | 6195      |



# TOULOUSE



Hauteur complète 28"/35" | Hauteur de siège 16½" | Hauteur devant bras 21" | Profondeur d'assise 23"  
 Total Height 28"/35" | Seat Height 16½" | Arm Height 21" | Seat Depth 23"

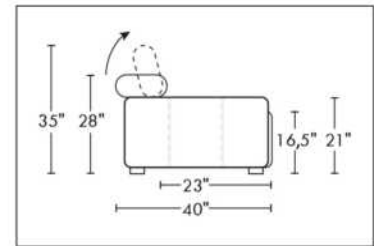
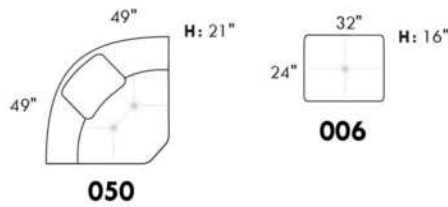
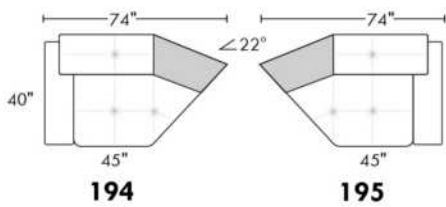
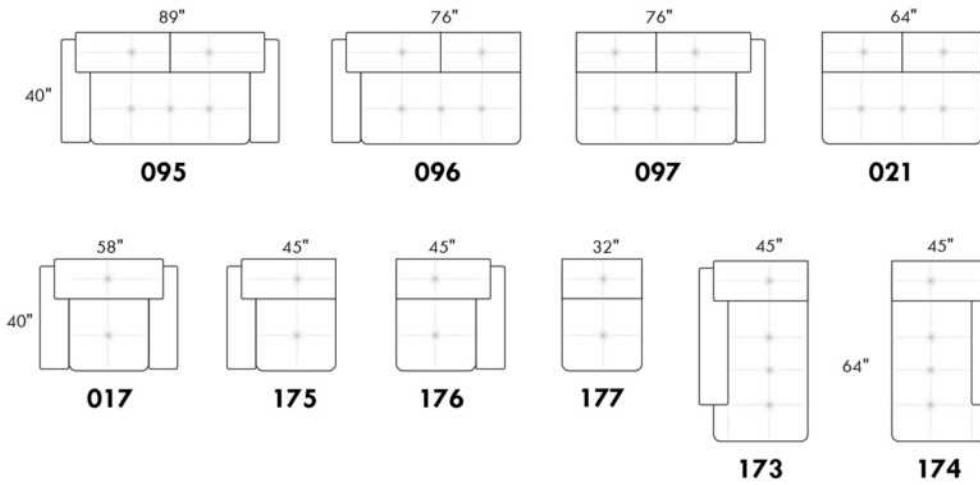

## CONFIGURATIONS

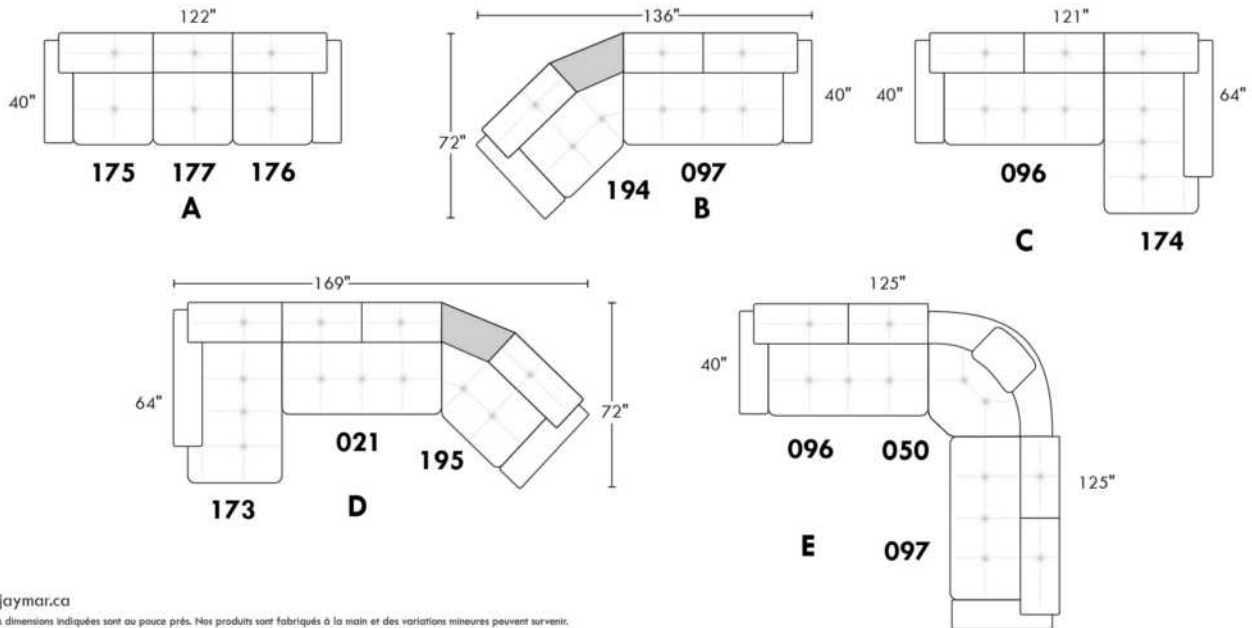

www.jaymar.ca  
 Toutes les dimensions indiquées sont au pouce près. Nos produits sont fabriqués à la main et des variations mineures peuvent survenir.  
 All dimensions indicated are to the nearest inch. Our product is hand-made and minor variations can occur.

## VALENCE

### FEATURES:

- Manual adjustable headrest on all items (2 on square corner & stationary on wedge).
- \*Wall hugger power recliners with full footrest (manual n/a).
- Power recliner lounge chair (manual n/a) with power headrest in option. Wall clearance 8" & front 5".
- Seat cushions with shaped foam + 1" layer of memory foam on top.
- Stitching: Small thread in fabric & large flat thread in leather.
- \*Excludes 043 & 163 chairs: Wall clearance 16"

Note: 2 recliner seats separated by a corner can not be opened at the same time. No recliner seats beside #155 Small Square Corner.

### OPTIONS

- Battery Pack: Add \$160/ea.
- \*Motorized headrest: Add \$160 ea. (\*N/A on stationary items).
- Foam: Extra firm add \$15/seat.
- Choice of Large or Small 6" Arm: Leg on LARGE arm: LG08 wood. Leg on SMALL Arm: LG195 wood. Specify colour of wood leg.
- Seat Depth: 20" or \*22". \*22" seat depth N/A on chairs 043 & 163.
- 043 & 163 Chairs: with wood base (specify colour).

| Description                        | L x D x H     | Leather |                       |  |  |                                  |                           | Fabric |          |           |
|------------------------------------|---------------|---------|-----------------------|--|--|----------------------------------|---------------------------|--------|----------|-----------|
|                                    |               | 10      | 20<br>Madras<br>Softy | 30<br>Hugo<br>Fantasy<br>Illusion<br>Tucson<br>Utah<br>Vintage<br>Wild Laredo<br>Yukon | 40<br>Elegance<br>Princess<br>Santiago<br>Sensation<br>Sunset<br>Trina<br>Victoria | 50<br>Bull<br>Cassiope<br>Dublin | 60<br>Caress<br>Ultrasued | A      | B<br>COM | C<br>alta |
| 001 CHAIR                          | 40x40x33/40   | 1890    | 1980                  | 2070   | 2160   | 2250                             | 2340                      | 1535   | 1580     | 1625      |
| 002 LOVESEAT                       | 63x40x33/40   | 2700    | 2815                  | 2930   | 3045   | 3160                             | 3275                      | 2175   | 2250     | 2325      |
| 003 SOFA                           | 87x40x33/40   | 3265    | 3415                  | 3565   | 3715   | 3865                             | 4015                      | 2625   | 2715     | 2805      |
| 005 LOUNGE CHAIR RIGHT ARM         | 32x62x33/40   | 1765    | 1830                  | 1895   | 1960   | 2025                             | 2090                      | 1410   | 1470     | 1530      |
| 009 ARMLESS LOVESEAT               | 47x40x33/40   | 1895    | 1965                  | 2035   | 2105   | 2175                             | 2245                      | 1490   | 1570     | 1650      |
| 011 LOUNGE CHAIR LEFT ARM          | 32x62x33/40   | 1765    | 1830                  | 1895   | 1960   | 2025                             | 2090                      | 1410   | 1470     | 1530      |
| 012 LOVESEAT LEFT ARM              | 55x40x33/40   | 2320    | 2420                  | 2520   | 2620   | 2720                             | 2820                      | 1850   | 1925     | 2000      |
| 017 DOUBLE CHAIR                   | 47x40x33/40   | 1980    | 2080                  | 2180   | 2280   | 2380                             | 2480                      | 1600   | 1660     | 1720      |
| 021 APARTMENT SOFA NO ARM          | 61x40x33/40   | 2140    | 2240                  | 2340   | 2440   | 2540                             | 2640                      | 1670   | 1755     | 1840      |
| 040 ARMLESS SOFA                   | 71x40x33/40   | 2450    | 2565                  | 2680   | 2795   | 2910                             | 3025                      | 1950   | 2040     | 2130      |
| 041 RECLINING CHAIR LEFT ARM       | 32x40x33/40   | 1885    | 1960                  | 2035   | 2110   | 2185                             | 2260                      | 1605   | 1640     | 1675      |
| 042 RECLINING CHAIR RIGHT ARM      | 32x40x33/40   | 1885    | 1960                  | 2035   | 2110   | 2185                             | 2260                      | 1605   | 1640     | 1675      |
| 043 SWIVEL ROCKING RECLINING CHAIR | 30/33x34x42   | 2235    | 2345                  | 2455   | 2565   | 2675                             | 2785                      | 1875   | 1920     | 1965      |
| 044 RECLINER CHAIR                 | 40x40x33/40   | 2275    | 2365                  | 2455   | 2545   | 2635                             | 2725                      | 1920   | 1970     | 2020      |
| 045 ARMLESS LOVESEAT BUMPER RIGHT  | 68x40x33/40   | 2245    | 2340                  | 2435   | 2530   | 2625                             | 2720                      | 1785   | 1850     | 1915      |
| 050 WEDGE                          | 49x49x33      | 1645    | 1745                  | 1845   | 1945   | 2045                             | 2145                      | 1210   | 1270     | 1330      |
| 051 ARMLESS CHAIR                  | 23,5x40x33/40 | 1085    | 1135                  | 1185   | 1235   | 1285                             | 1335                      | 845    | 900      | 955       |
| 052 SOFA LEFT ARM                  | 79x40x33/40   | 2870    | 3005                  | 3140   | 3275   | 3410                             | 3545                      | 2290   | 2385     | 2480      |
| 053 SOFA RIGHT ARM                 | 79x40x33/40   | 2870    | 3005                  | 3140   | 3275   | 3410                             | 3545                      | 2290   | 2385     | 2480      |

## VALENCE

### FEATURES:

- Manual adjustable headrest on all items (2 on square corner & stationary on wedge).
- \*Wall hugger power recliners with full footrest (manual n/a).
- Power recliner lounge chair (manual n/a) with power headrest in option. Wall clearance 8" & front 5".
- Seat cushions with shaped foam + 1" layer of memory foam on top.
- Stitching: Small thread in fabric & large flat thread in leather.
- \*Excludes 043 & 163 chairs: Wall clearance 16"

Note: 2 recliner seats separated by a corner can not be opened at the same time. No recliner seats beside #155 Small Square Corner.

### OPTIONS

- Battery Pack: Add \$160/ea.
- \*Motorized headrest: Add \$160 ea. (\*N/A on stationary items).
- Foam: Extra firm add \$15/seat.
- Choice of Large or Small 6" Arm: Leg on LARGE arm: LG08 wood. Leg on SMALL Arm: LG195 wood. Specify colour of wood leg.
- Seat Depth: 20" or \*22". \*22" seat depth N/A on chairs 043 & 163.
- 043 & 163 Chairs: with wood base (specify colour).

| Description                            | L x D x H      | Leather |                       |  |  |                                  |                           | Fabric |          |           |
|--|----------------|---------|-----------------------|--|--|----------------------------------|---------------------------|--------|----------|-----------|
|  |                | 10      | 20<br>Madras<br>Softy | 30<br>Hugo<br>Fantasy<br>Illusion<br>Tucson<br>Utah<br>Vintage<br>Wild Laredo<br>Yukon | 40<br>Elegance<br>Princess<br>Santiago<br>Sensation<br>Sunset<br>Trina<br>Victoria | 50<br>Bull<br>Cassiope<br>Dublin | 60<br>Caress<br>Ultrasued | A      | B<br>COM | C<br>alta |
| 055 SQUARE CORNER                      | 44x44x33/40    | 1915    | 2010                  | 2105   | 2200   | 2295                             | 2390                      | 1510   | 1565     | 1620      |
| 056 CHAIR RIGHT ARM                    | 32x40x33/40    | 1510    | 1575                  | 1640   | 1705   | 1770                             | 1835                      | 1200   | 1260     | 1320      |
| 057 CHAIR LEFT ARM                     | 32x40x33/40    | 1510    | 1575                  | 1640   | 1705   | 1770                             | 1835                      | 1200   | 1260     | 1320      |
| 061 LOVESEAT RIGHT ARM                 | 55x40x33/40    | 2320    | 2420                  | 2520   | 2620   | 2720                             | 2820                      | 1850   | 1925     | 2000      |
| 071 ARMLESS RECLINING CHAIR            | 23,5x40x33/40  | 1470    | 1525                  | 1580   | 1635   | 1690                             | 1745                      | 1250   | 1310     | 1370      |
| 086 ARMLESS LOVESEAT BUMPER LEFT       | 68x40x33/40    | 2245    | 2340                  | 2435   | 2530   | 2625                             | 2720                      | 1785   | 1850     | 1915      |
| 088 ARMLESS CHAIR BUMPER LEFT          | 45x40x33/40    | 1440    | 1535                  | 1630   | 1725   | 1820                             | 1915                      | 1130   | 1165     | 1200      |
| 089 ARMLESS CHAIR BUMPER RIGHT         | 45x40x33/40    | 1440    | 1535                  | 1630   | 1725   | 1820                             | 1915                      | 1130   | 1165     | 1200      |
| 095 APARTMENT SOFA                     | 77x40x33/40    | 2940    | 3085                  | 3230   | 3375   | 3520                             | 3665                      | 2350   | 2445     | 2540      |
| 096 APARTMENT SOFA LEFT ARM            | 69x40x33/40    | 2570    | 2680                  | 2790   | 2900   | 3010                             | 3120                      | 2020   | 2110     | 2200      |
| 097 APARTMENT SOFA RIGHT ARM           | 69x40x33/40    | 2570    | 2680                  | 2790   | 2900   | 3010                             | 3120                      | 2020   | 2110     | 2200      |
| 124 STORAGE OTTOMAN                    | 30x22x17       | 745     | 765                   | 785  | 805  | 825                              | 845                       | 650    | 670      | 690       |
| 155 SMALL SQUARE CORNER                | 40x40x33/40    | 1915    | 2010                  | 2105   | 2200   | 2295                             | 2390                      | 1510   | 1565     | 1620      |
| 163 DBL SWIVEL ROCKING RECLINER CHAIR  | 33/36x40x33/40 | 2290    | 2410                  | 2530   | 2650   | 2770                             | 2890                      | 1880   | 1930     | 1980      |
| 165 DOUBLE RECLINING CHAIR             | 47x40x33/40    | 2375    | 2475                  | 2575   | 2675   | 2775                             | 2875                      | 2000   | 2065     | 2130      |
| 167 APARTMENT SOFA NO ARM BUMPER LEFT  | 82x40x33/40    | 2490    | 2620                  | 2750   | 2880   | 3010                             | 3140                      | 1960   | 2045     | 2130      |
| 168 APARTMENT SOFA NO ARM BUMPER RIGHT | 82x40x33/40    | 2490    | 2620                  | 2750   | 2880   | 3010                             | 3140                      | 1960   | 2045     | 2130      |
| 169 DOUBLE RECLINING CHAIR LEFT ARM    | 39x40x33/40    | 1990    | 2070                  | 2150   | 2230   | 2310                             | 2390                      | 1670   | 1750     | 1830      |
| 170 DOUBLE RECLINING CHAIR RIGHT ARM   | 39x40x33/40    | 1990    | 2070                  | 2150   | 2230   | 2310                             | 2390                      | 1670   | 1750     | 1830      |
| 171 ARMLESS DOUBLE RECLINING CHAIR     | 30,5x40x33/40  | 1575    | 1625                  | 1675   | 1725   | 1775                             | 1825                      | 1320   | 1380     | 1440      |

## VALENCE

### FEATURES:

- Manual adjustable headrest on all items (2 on square corner & stationary on wedge).
- \*Wall hugger power recliners with full footrest (manual n/a).
- Power recliner lounge chair (manual n/a) with power headrest in option. Wall clearance 8" & front 5".
- Seat cushions with shaped foam + 1" layer of memory foam on top.
- Stitching: Small thread in fabric & large flat thread in leather.
- \*Excludes 043 & 163 chairs: Wall clearance 16"

Note: 2 recliner seats separated by a corner can not be opened at the same time. No recliner seats beside #155 Small Square Corner.

### OPTIONS

- Battery Pack: Add \$160/ea.
- \*Motorized headrest: Add \$160 ea. (\*N/A on stationary items).
- Foam: Extra firm add \$15/seat.
- Choice of Large or Small 6" Arm: Leg on LARGE arm: LG08 wood. Leg on SMALL Arm: LG195 wood. Specify colour of wood leg.
- Seat Depth: 20" or \*22". \*22" seat depth N/A on chairs 043 & 163.
- 043 & 163 Chairs: with wood base (specify colour).

| Description                            | L x D x H     | Leather |                       |  |  |                                  |                           | Fabric |          |           |
|--|---------------|---------|-----------------------|--|--|----------------------------------|---------------------------|--------|----------|-----------|
|  |               | 10      | 20<br>Madras<br>Softy | 30<br>Hugo<br>Fantasy<br>Illusion<br>Tucson<br>Utah<br>Vintage<br>Wild Laredo<br>Yukon | 40<br>Elegance<br>Princess<br>Santiago<br>Sensation<br>Sunset<br>Trina<br>Victoria | 50<br>Bull<br>Cassiope<br>Dublin | 60<br>Caress<br>Ultrasued | A      | B<br>COM | C<br>alta |
| 173 DOUBLE LOUNGE CHAIR LEFT ARM       | 39x62x33/40   | 1915    | 2005                  | 2095   | 2185   | 2275                             | 2365                      | 1535   | 1615     | 1695      |
| 174 DOUBLE LOUNGE CHAIR RIGHT ARM      | 39x62x33/40   | 1915    | 2005                  | 2095   | 2185   | 2275                             | 2365                      | 1535   | 1615     | 1695      |
| 175 DOUBLE CHAIR LEFT ARM              | 39x40x33/40   | 1590    | 1680                  | 1770   | 1860   | 1950                             | 2040                      | 1285   | 1350     | 1415      |
| 176 DOUBLE CHAIR RIGHT ARM             | 39x40x33/40   | 1590    | 1680                  | 1770   | 1860   | 1950                             | 2040                      | 1285   | 1350     | 1415      |
| 177 ARMLESS DOUBLE CHAIR               | 30,5x40x33/40 | 1185    | 1250                  | 1315   | 1380   | 1445                             | 1510                      | 915    | 970      | 1025      |
| 178 ARMLESS DOUBLE CHAIR BUMPER LEFT   | 52x40x33/40   | 1545    | 1625                  | 1705   | 1785   | 1865                             | 1945                      | 1230   | 1290     | 1350      |
| 179 ARMLESS DOUBLE CHAIR BUMPER RIGHT  | 52x40x33/40   | 1545    | 1625                  | 1705   | 1785   | 1865                             | 1945                      | 1230   | 1290     | 1350      |
| 186 ARMLESS LOVESEAT BUMPER STORAGE-L  | 68x40x33/40   | 2420    | 2500                  | 2580   | 2660   | 2740                             | 2820                      | 1950   | 2015     | 2080      |
| 187 ARMLESS LOVESEAT BUMPER STORAGE-R  | 68x40x33/40   | 2420    | 2500                  | 2580   | 2660   | 2740                             | 2820                      | 1950   | 2015     | 2080      |
| 188 ARMLESS CHAIR BUMPER STORAGE-L     | 45x40x33/40   | 1600    | 1690                  | 1780   | 1870   | 1960                             | 2050                      | 1295   | 1330     | 1365      |
| 189 ARMLESS CHAIR BUMPER STORAGE-R     | 45x40x33/40   | 1600    | 1690                  | 1780   | 1870   | 1960                             | 2050                      | 1295   | 1330     | 1365      |
| 221 ARMLESS DBL CHAIR BUMPER STORAGE-L | 52x40x33/40   | 1705    | 1790                  | 1875   | 1960   | 2045                             | 2130                      | 1390   | 1450     | 1510      |
| 222 ARMLESS DBL CHAIR BUMPER STORAGE-R | 52x40x33/40   | 1705    | 1790                  | 1875   | 1960   | 2045                             | 2130                      | 1390   | 1450     | 1510      |
| 223 APT SOFA NO ARM BUMPER STORAGE-L   | 82x40x33/40   | 2655    | 2785                  | 2915   | 3045   | 3175                             | 3305                      | 2120   | 2215     | 2310      |
| 224 APT SOFA NO ARM BUMPER STORAGE-R   | 82x40x33/40   | 2655    | 2785                  | 2915   | 3045   | 3175                             | 3305                      | 2120   | 2215     | 2310      |
| 236 RECLINING LOUNGE CHAIR LEFT ARM    | 32x62x33/40   | 2160    | 2225                  | 2290   | 2355   | 2420                             | 2485                      | 1820   | 1880     | 1940      |
| 237 RECLINING LOUNGE CHAIR RIGHT ARM   | 32x62x33/40   | 2160    | 2225                  | 2290   | 2355   | 2420                             | 2485                      | 1820   | 1880     | 1940      |
| 238 RECLINING DBL LOUNGE CHAIR L-ARM   | 39x62x33/40   | 2315    | 2405                  | 2495   | 2585   | 2675                             | 2765                      | 1940   | 2020     | 2100      |
| 239 RECLINING DBL LOUNGE CHAIR R-ARM   | 39x62x33/40   | 2315    | 2405                  | 2495   | 2585   | 2675                             | 2765                      | 1940   | 2020     | 2100      |
| <b>CONFIGURATIONS</b>                  |               |         |                       |  |  |                                  |                           |        |          |           |

## CDN Price List

### VALENCE

| Description                | L x D x H  | Leather |                       |  |  |                                  |                           | Fabric |          |           |
|----------------------------|------------|---------|-----------------------|--|--|----------------------------------|---------------------------|--------|----------|-----------|
|                            |            | 10      | 20<br>Madras<br>Softy | 30<br>Hugo<br>Fantasy<br>Illusion<br>Tucson<br>Utah<br>Vintage<br>Wild Laredo<br>Yukon | 40<br>Elegance<br>Princess<br>Santiago<br>Sensation<br>Sunset<br>Trina<br>Victoria | 50<br>Bull<br>Cassiope<br>Dublin | 60<br>Caress<br>Ultrasued | A      | B<br>COM | C<br>alta |
| A CONFIG (169-170)         | 78X40X40   | 3980    | 4140                  | 4300   | 4460   | 4620                             | 4780                      | 3340   | 3500     | 3660      |
| B CONFIG (169-171-174)     | 109X62X40  | 5480    | 5700                  | 5920   | 6140   | 6360                             | 6580                      | 4525   | 4745     | 4965      |
| C CONFIG (096-055-171-170) | 114X114X40 | 8050    | 8385                  | 8720   | 9055   | 9390                             | 9725                      | 6520   | 6805     | 7090      |
| D CONFIG (169-171-055-179) | 114X96X40  | 7025    | 7330                  | 7635   | 7940   | 8245                             | 8550                      | 5730   | 5985     | 6240      |
| J CONFIG (041-042)         | 64X40X40   | 3770    | 3920                  | 4070   | 4220   | 4370                             | 4520                      | 3210   | 3280     | 3350      |
| K CONFIG (041-071-005)     | 88X62X40   | 5120    | 5315                  | 5510   | 5705   | 5900                             | 6095                      | 4265   | 4420     | 4575      |
| L CONFIG (012-055-071-042) | 100X100X40 | 7590    | 7915                  | 8240   | 8565   | 8890                             | 9215                      | 6215   | 6440     | 6665      |
| M CONFIG (041-071-055-089) | 100X89X40  | 6710    | 7030                  | 7350   | 7670   | 7990                             | 8310                      | 5495   | 5680     | 5865      |



# VALENCE

**OPTIMA**  
Collection

**Jaymar**

Conçu et fabriqué fièrement au Canada  
Proudly designed and made in Canada

Nos produits sont fabriqués à la main et des variations mineures peuvent survenir

Our product is hand-made and minor variations can occur.

## SPECIFICATIONS

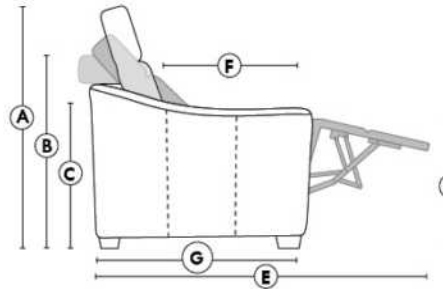

- Appui-tête levé / Headrest up
- Appui-tête baissé / Headrest down
- Complètement incliné / Fully reclined

- A** Hauteur complète 40" Total Height
- B** Hauteur appui-tête baissé 33" Height headrest down
- C** Hauteur du bras 23" Arm Height
- D** Hauteur du siège 19,5" Seat height
- E** Profondeur inclinée 65" Depth fully reclined
- F** Profondeur d'assise 20"ou/ou 22" Seat depth
- G** Profondeur appui-tête monté 37,5" Depth with headrest up

## BRAS | ARMS

Option de bras:  
Bras Régulier Large 8" ou Petit bras 6"

Arm option  
Regular arm Large 8" or Small arm 6"

Contrôle de l'inclinaison situé à l'extérieur du bras  
Recliner control located on the outside of the arm.

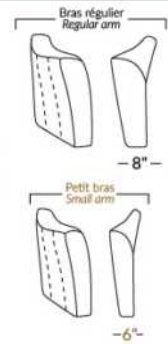

## FAUTEUIL BERÇANT PIVOTANT INCLINABLE SWIVEL ROCKING MOTION CHAIR

Dégagement mural de 16" Wall clearance  
Hauteur de 42" Height  
Largeur de bras 6" Arms width  
Option base de bois | Wood base option

|     | Petit/Small<br>19" | Double<br>22" |
|-----|--------------------|---------------|
| 34" | 043                | 163           |
|     | 30"                | 33"           |

## SIÈGE 23" DE LARGE | 23" SEAT WIDTH

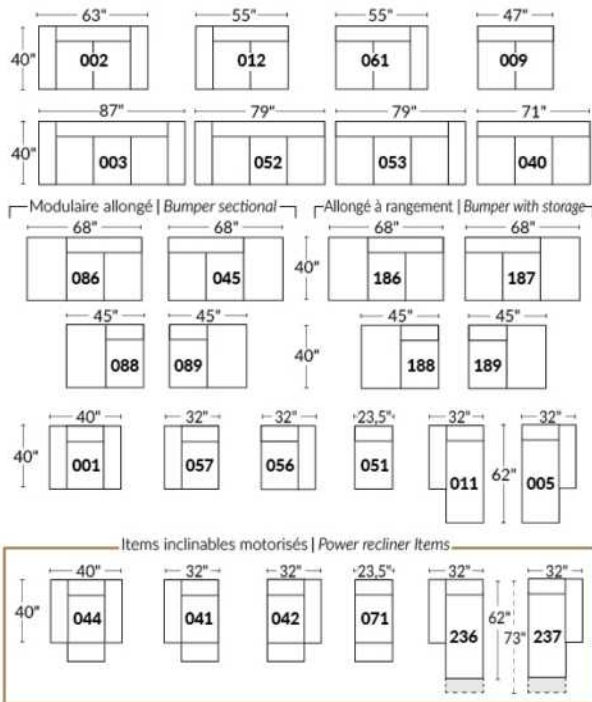

## SIÈGE 30" DE LARGE | 30" SEAT WIDTH

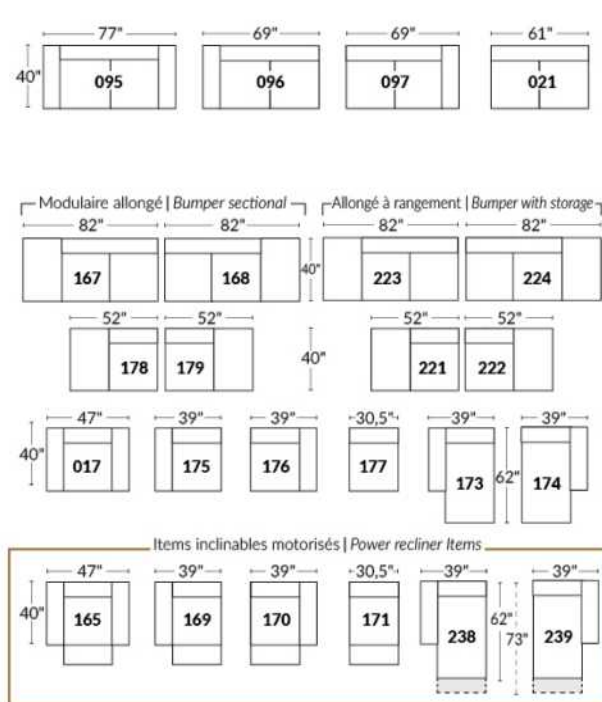

### Autres | Others

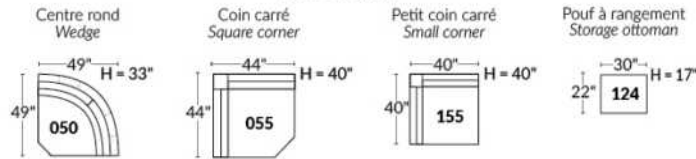

## EXEMPLE 23" EXAMPLE

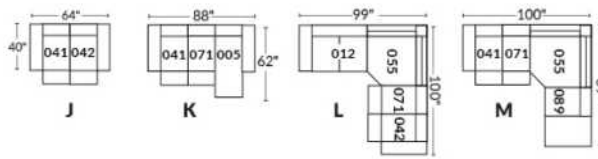

## EXEMPLE 30" EXAMPLE

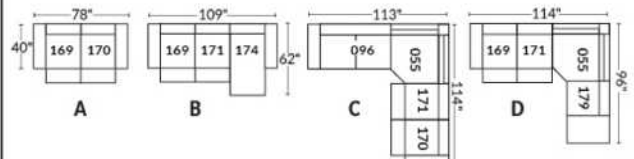

## VANDA

Features: Manual adjustable headrest included with all items (2 with square corner). Headrest STATIONARY on Wedge (050). Stitching: Small "French Stitch" in fabric & in leather. Swivel Rocking Recliner Chairs (items 043 & 163 only): seat cushions with 1" memory foam.

Note: 2 recliner seats separated by a wedge (050) or square corner (055) cannot be opened at the same time.

OPTIONS - Provide SKETCH of your config.:

Small 6" Arm: at same price.

Leg (specify colour): On LARGE arm: LG103 wood or LG189 metal (Black or Chrome). SMALL Arm LEG: LG08 wood or LG64 metal.

Choice of Seat Depth: 20" or \*22". The \*22" seat depth N/A on chairs #043 & #163.

043 & 163 Chairs: with wood base (specify colour).

Foam (Extra Firm or Memory): Add \$15/seat. Bumper section counts as 1 seat & lounge chairs as 2 seats.

Motorized recliner mechanism with touch-sensor button add \$160/mechanism. | For Battery Pack: add \$320/mechanism.

| Description                        | L x D x H     | Leather |                       |  |  |                                  |                           | Fabric |          |           |
|------------------------------------|---------------|---------|-----------------------|--|--|----------------------------------|---------------------------|--------|----------|-----------|
|                                    |               | 10      | 20<br>Madras<br>Softy | 30<br>Hugo<br>Fantasy<br>Illusion<br>Tucson<br>Utah<br>Vintage<br>Wild Laredo<br>Yukon | 40<br>Elegance<br>Princess<br>Santiago<br>Sensation<br>Sunset<br>Trina<br>Victoria | 50<br>Bull<br>Cassiope<br>Dublin | 60<br>Caress<br>Ultrasued | A      | B<br>COM | C<br>alta |
| 001 CHAIR                          | 44X40X33/40   | 1630    | 1725                  | 1820   | 1915   | 2010                             | 2105                      | 1235   | 1295     | 1355      |
| 002 LOVESEAT                       | 67X40X33/40   | 2365    | 2485                  | 2605   | 2725   | 2845                             | 2965                      | 1800   | 1865     | 1930      |
| 003 SOFA                           | 91X40X33/40   | 2890    | 3045                  | 3200   | 3355   | 3510                             | 3665                      | 2180   | 2275     | 2370      |
| 005 LOUNGE CHAIR RIGHT ARM         | 34X62X33/40   | 1555    | 1625                  | 1695   | 1765   | 1835                             | 1905                      | 1155   | 1225     | 1295      |
| 009 ARMLESS LOVESEAT               | 47X40X33/40   | 1770    | 1835                  | 1900   | 1965   | 2030                             | 2095                      | 1330   | 1390     | 1450      |
| 011 LOUNGE CHAIR LEFT ARM          | 34X62X33/40   | 1555    | 1625                  | 1695   | 1765   | 1835                             | 1905                      | 1155   | 1225     | 1295      |
| 012 LOVESEAT LEFT ARM              | 57X40X33/40   | 2070    | 2160                  | 2250   | 2340   | 2430                             | 2520                      | 1575   | 1640     | 1705      |
| 017 DOUBLE CHAIR                   | 51X40X33/40   | 1750    | 1840                  | 1930   | 2020   | 2110                             | 2200                      | 1320   | 1370     | 1420      |
| 021 APARTMENT SOFA NO ARM          | 61X40X33/40   | 2010    | 2090                  | 2170   | 2250   | 2330                             | 2410                      | 1510   | 1600     | 1690      |
| 040 ARMLESS SOFA                   | 71X40X33/40   | 2280    | 2360                  | 2440   | 2520   | 2600                             | 2680                      | 1725   | 1815     | 1905      |
| 041 RECLINING CHAIR LEFT ARM       | 34X40X33/40   | 1495    | 1575                  | 1655   | 1735   | 1815                             | 1895                      | 1175   | 1230     | 1285      |
| 042 RECLINING CHAIR RIGHT ARM      | 34X40X33/40   | 1495    | 1575                  | 1655   | 1735   | 1815                             | 1895                      | 1175   | 1230     | 1285      |
| 043 SWIVEL ROCKING RECLINING CHAIR | 30x34x42      | 1965    | 2060                  | 2155   | 2250   | 2345                             | 2440                      | 1600   | 1645     | 1690      |
| 044 RECLINER CHAIR                 | 44X40X33/40   | 1800    | 1905                  | 2010   | 2115   | 2220                             | 2325                      | 1425   | 1480     | 1535      |
| 045 ARMLESS LOVESEAT BUMPER RIGHT  | 68X40X33/40   | 2080    | 2175                  | 2270   | 2365   | 2460                             | 2555                      | 1580   | 1650     | 1720      |
| 050 WEDGE                          | 49X49X33      | 1555    | 1640                  | 1725   | 1810   | 1895                             | 1980                      | 1100   | 1150     | 1200      |
| 051 ARMLESS CHAIR                  | 23,5X40X33/40 | 1005    | 1055                  | 1105   | 1155   | 1205                             | 1255                      | 765    | 820      | 875       |
| 052 SOFA LEFT ARM                  | 81X40X33/40   | 2590    | 2695                  | 2800   | 2905   | 3010                             | 3115                      | 1950   | 2040     | 2130      |
| 053 SOFA RIGHT ARM                 | 81X40X33/40   | 2590    | 2695                  | 2800   | 2905   | 3010                             | 3115                      | 1950   | 2040     | 2130      |
| 055 SQUARE CORNER                  | 44X44X33/40   | 1825    | 1925                  | 2025   | 2125   | 2225                             | 2325                      | 1390   | 1455     | 1520      |
| 056 CHAIR RIGHT ARM                | 34X40X33/40   | 1320    | 1395                  | 1470   | 1545   | 1620                             | 1695                      | 1000   | 1045     | 1090      |
| 057 CHAIR LEFT ARM                 | 34X40X33/40   | 1320    | 1395                  | 1470   | 1545   | 1620                             | 1695                      | 1000   | 1045     | 1090      |

## VANDA

Features: Manual adjustable headrest included with all items (2 with square corner). Headrest STATIONARY on Wedge (050). Stitching: Small "French Stitch" in fabric & in leather. Swivel Rocking Recliner Chairs (items 043 & 163 only): seat cushions with 1" memory foam.

Note: 2 recliner seats separated by a wedge (050) or square corner (055) cannot be opened at the same time.

OPTIONS - Provide SKETCH of your config.:

Small 6" Arm: at same price.

Leg (specify colour): On LARGE arm: LG103 wood or LG189 metal (Black or Chrome). SMALL Arm LEG: LG08 wood or LG64 metal.

Choice of Seat Depth: 20" or \*22". The \*22" seat depth N/A on chairs #043 & #163.

043 & 163 Chairs: with wood base (specify colour).

Foam (Extra Firm or Memory): Add \$15/seat. Bumper section counts as 1 seat & lounge chairs as 2 seats.

Motorized recliner mechanism with touch-sensor button add \$160/mechanism. | For Battery Pack: add \$320/mechanism.

| Description                            | L x D x H     | Leather |                       |  |  |                                  |                           | Fabric |          |           |
|--|---------------|---------|-----------------------|--|--|----------------------------------|---------------------------|--------|----------|-----------|
|  |               | 10      | 20<br>Madras<br>Softy | 30<br>Hugo<br>Fantasy<br>Illusion<br>Tucson<br>Utah<br>Vintage<br>Wild Laredo<br>Yukon | 40<br>Elegance<br>Princess<br>Santiago<br>Sensation<br>Sunset<br>Trina<br>Victoria | 50<br>Bull<br>Cassiope<br>Dublin | 60<br>Caress<br>Ultrasued | A      | B<br>COM | C<br>alta |
| 061 LOVESEAT RIGHT ARM                 | 57X40X33/40   | 2070    | 2160                  | 2250   | 2340   | 2430                             | 2520                      | 1575   | 1640     | 1705      |
| 071 ARMLESS RECLINING CHAIR            | 23,5X40X33/40 | 1185    | 1250                  | 1315   | 1380   | 1445                             | 1510                      | 955    | 1020     | 1085      |
| 086 ARMLESS LOVESEAT BUMPER LEFT       | 68X40X33/40   | 2080    | 2175                  | 2270   | 2365   | 2460                             | 2555                      | 1580   | 1650     | 1720      |
| 088 ARMLESS CHAIR BUMPER LEFT          | 45X40X33/40   | 1330    | 1410                  | 1490   | 1570   | 1650                             | 1730                      | 1005   | 1050     | 1095      |
| 089 ARMLESS CHAIR BUMPER RIGHT         | 45X40X33/40   | 1330    | 1410                  | 1490   | 1570   | 1650                             | 1730                      | 1005   | 1050     | 1095      |
| 095 APARTMENT SOFA                     | 81X40X33/40   | 2625    | 2780                  | 2935   | 3090   | 3245                             | 3400                      | 1980   | 2070     | 2160      |
| 096 APARTMENT SOFA LEFT ARM            | 71X40X33/40   | 2315    | 2430                  | 2545   | 2660   | 2775                             | 2890                      | 1750   | 1835     | 1920      |
| 097 APARTMENT SOFA RIGHT ARM           | 71X40X33/40   | 2315    | 2430                  | 2545   | 2660   | 2775                             | 2890                      | 1750   | 1835     | 1920      |
| 124 STORAGE OTTOMAN                    | 30X22X17      | 705     | 730                   | 755  | 780  | 805                              | 830                       | 605    | 615      | 625       |
| 163 DBL SWIVEL ROCKING RECLINER CHAIR  | 33 x 34 x 42  | 2010    | 2125                  | 2240   | 2355   | 2470                             | 2585                      | 1605   | 1650     | 1695      |
| 165 DOUBLE RECLINING CHAIR             | 51X40X33/40   | 1920    | 2025                  | 2130   | 2235   | 2340                             | 2445                      | 1495   | 1565     | 1635      |
| 167 APARTMENT SOFA NO ARM BUMPER LEFT  | 82X40X33/40   | 2320    | 2440                  | 2560   | 2680   | 2800                             | 2920                      | 1770   | 1855     | 1940      |
| 168 APARTMENT SOFA NO ARM BUMPER RIGHT | 82X40X33/40   | 2320    | 2440                  | 2560   | 2680   | 2800                             | 2920                      | 1770   | 1855     | 1940      |
| 169 DOUBLE RECLINING CHAIR LEFT ARM    | 41X40X33/40   | 1605    | 1690                  | 1775   | 1860   | 1945                             | 2030                      | 1285   | 1335     | 1385      |
| 170 DOUBLE RECLINING CHAIR RIGHT ARM   | 41X40X33/40   | 1605    | 1690                  | 1775   | 1860   | 1945                             | 2030                      | 1285   | 1335     | 1385      |
| 171 ARMLESS DOUBLE RECLINING CHAIR     | 30,5X40X33/40 | 1305    | 1355                  | 1405   | 1455   | 1505                             | 1555                      | 1030   | 1095     | 1160      |
| 173 DOUBLE LOUNGE CHAIR LEFT ARM       | 41X62X33/40   | 1695    | 1785                  | 1875   | 1965   | 2055                             | 2145                      | 1295   | 1375     | 1455      |
| 174 DOUBLE LOUNGE CHAIR RIGHT ARM      | 41X62X33/40   | 1695    | 1785                  | 1875   | 1965   | 2055                             | 2145                      | 1295   | 1375     | 1455      |
| 175 DOUBLE CHAIR LEFT ARM              | 41X40X33/40   | 1420    | 1500                  | 1580   | 1660   | 1740                             | 1820                      | 1085   | 1145     | 1205      |
| 176 DOUBLE CHAIR RIGHT ARM             | 41X40X33/40   | 1420    | 1500                  | 1580   | 1660   | 1740                             | 1820                      | 1085   | 1145     | 1205      |
| 177 ARMLESS DOUBLE CHAIR               | 30,5X40X33/40 | 1120    | 1175                  | 1230   | 1285   | 1340                             | 1395                      | 845    | 905      | 965       |
| 178 ARMLESS DOUBLE CHAIR BUMPER LEFT   | 52X40X33/40   | 1440    | 1535                  | 1630   | 1725   | 1820                             | 1915                      | 1095   | 1150     | 1205      |



## VANDA

Features: Manual adjustable headrest included with all items (2 with square corner). Headrest STATIONARY on Wedge (050). Stitching: Small "French Stitch" in fabric & in leather. Swivel Rocking Recliner Chairs (items 043 & 163 only): seat cushions with 1" memory foam.

Note: 2 recliner seats separated by a wedge (050) or square corner (055) cannot be opened at the same time.

OPTIONS - Provide SKETCH of your config.:

Small 6" Arm: at same price.

Leg (specify colour): On LARGE arm: LG103 wood or LG189 metal (Black or Chrome). SMALL Arm LEG: LG08 wood or LG64 metal.

Choice of Seat Depth: 20" or \*22". The \*22" seat depth N/A on chairs #043 & #163.

043 & 163 Chairs: with wood base (specify colour).

Foam (Extra Firm or Memory): Add \$15/seat. Bumper section counts as 1 seat & lounge chairs as 2 seats.

Motorized recliner mechanism with touch-sensor button add \$160/mechanism. | For Battery Pack: add \$320/mechanism.

| Description                           | L x D x H     | Leather |                       |  |  |                                  |                           | Fabric |          |           |
|---------------------------------------|---------------|---------|-----------------------|--|--|----------------------------------|---------------------------|--------|----------|-----------|
|                                       |               | 10      | 20<br>Madras<br>Softy | 30<br>Hugo<br>Fantasy<br>Illusion<br>Tucson<br>Utah<br>Vintage<br>Wild Laredo<br>Yukon | 40<br>Elegance<br>Princess<br>Santiago<br>Sensation<br>Sunset<br>Trina<br>Victoria | 50<br>Bull<br>Cassiope<br>Dublin | 60<br>Caress<br>Ultrasued | A      | B<br>COM | C<br>alta |
| 179 ARMLESS DOUBLE CHAIR BUMPER RIGHT | 52X40X33/40   | 1440    | 1535                  | 1630   | 1725   | 1820                             | 1915                      | 1095   | 1150     | 1205      |
| <b>CONFIGURATIONS</b>                 |               |         |                       |  |  |                                  |                           |        |          |           |
| A CONFIG (169-170)                    | 82X40X33/40   | 3210    | 3380                  | 3550   | 3720   | 3890                             | 4060                      | 2570   | 2670     | 2770      |
| B CONFIG (169-171-174)                | 113X62X33/40  | 4605    | 4830                  | 5055   | 5280   | 5505                             | 5730                      | 3610   | 3805     | 4000      |
| C CONFIG (096-055-171-170)            | 115X116X33/40 | 7050    | 7400                  | 7750   | 8100   | 8450                             | 8800                      | 5455   | 5720     | 5985      |
| D CONFIG (169-171-055-179)            | 116X96X33/40  | 6175    | 6505                  | 6835   | 7165   | 7495                             | 7825                      | 4800   | 5035     | 5270      |
| J CONFIG (041-042)                    | 68X40X33/40   | 2990    | 3150                  | 3310   | 3470   | 3630                             | 3790                      | 2350   | 2460     | 2570      |
| K CONFIG (041-071-005)                | 101X102X33/40 | 4235    | 4450                  | 4665   | 4880   | 5095                             | 5310                      | 3285   | 3475     | 3665      |
| L CONFIG (012-055-071-042)            | 101X102X33/40 | 6575    | 6910                  | 7245   | 7580   | 7915                             | 8250                      | 5095   | 5345     | 5595      |
| M CONFIG (041-071-055-089)            | 102X89X33/40  | 5835    | 6160                  | 6485   | 6810   | 7135                             | 7460                      | 4525   | 4755     | 4985      |



# VANDA

PARALLELE  
Collection 33

Jaymar

Conçu et fabriqué fièrement au Canada  
Proudly designed and made in Canada

Nos produits sont fabriqués à la main et des variations mineures peuvent survenir.

Our product is hand-made and minor variations can occur.

## SPECIFICATIONS

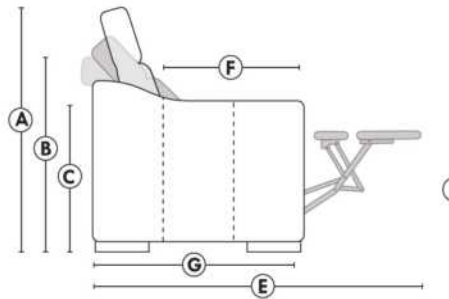

- Appui-tête levé Headrest up
- Appui-tête baissé Headrest down
- Complètement incliné Fully reclined

- A** Hauteur complète 40" Total Height
- B** Hauteur appui-tête baissé 33" Height headrest down
- C** Hauteur du bras 24" Arm Height
- D** Hauteur du siège 19,5" Seat height
- E** Profondeur incliné 65" Depth fully reclined
- F** Profondeur d'assise 20" ou/ou 22" Seat depth
- G** Profondeur appui-tête monté 36" Depth with headrest up

## BRAS | ARMS

Option de bras:  
Bras Régulier Large 9,5" ou Petit bras 6"

Arm option  
Regular arm Large 9.5" or Small arm 6"

Contrôle de l'inclinaison situé à l'intérieur du bras  
Recliner control located on the inside of the arm.

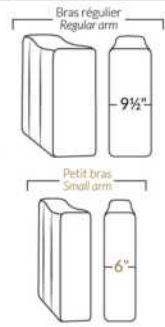

## FAUTEUIL BERÇANT PIVOTANT INCLINABLE SWIVEL ROCKING MOTION CHAIR

Dégagement mural de 16" Wall clearance  
Hauteur de 42" Height  
Largeur de bras 6" Arms width  
Option base de bois | Wood base option

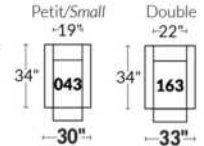

## SIÈGE 23" DE LARGE | 23" SEAT WIDTH

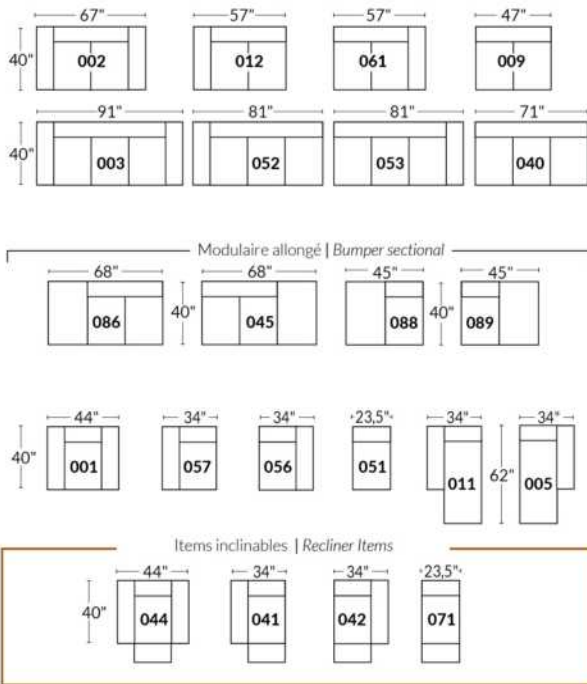

## SIÈGE 30" DE LARGE | 30" SEAT WIDTH

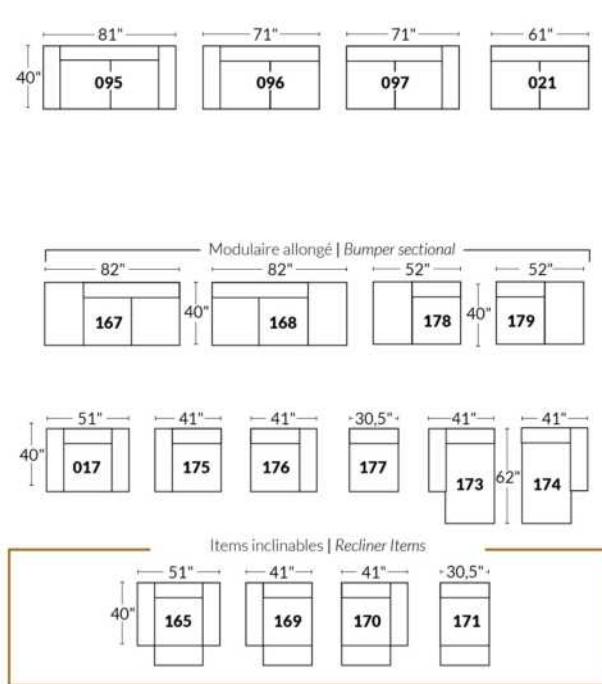

### Autres | Others

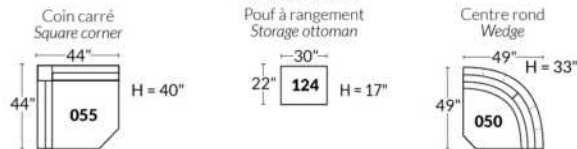

### EXEMPLE 23" EXAMPLE

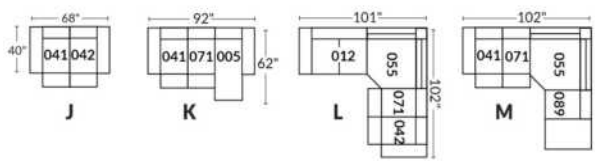

### EXEMPLE 30" EXAMPLE

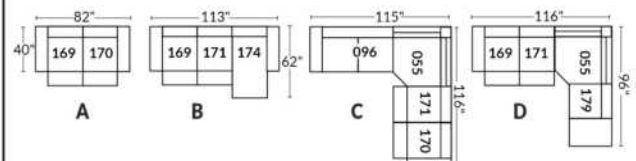

## VENICE

### FEATURES:

- Manual adjustable headrest on all items (2 on square corner & stationary on wedge).
- \*Wall hugger power recliners with full footrest (manual n/a).
- Power recliner lounge chair (manual n/a) with power headrest in option. Wall clearance 8" & front 5".
- Seat cushions with shaped foam + 1" layer of memory foam on top; arm with memory foam.
- Stitching: Small thread in fabric & large flat thread in leather.

\*Excludes 043 & 163 chairs: Wall clearance 16"

Note: 2 recliner seats separated by a corner can not be opened at the same time. No recliner seats beside item #155.

### OPTIONS

- Battery Pack: Add \$160/ea.
- \*Motorized headrest: Add \$160 ea. (\*N/A on stationary items).
- Foam: Extra firm add \$15/seat.
- Choice of Large or Small 6" Arm: Leg on LARGE arm: LG106 wood or LG189 metal (Black or Chrome). SMALL Arm: LG195 wood or LG196 metal (Black or Chrome). Specify colour.
- Seat Depth: 20" or \*22". \*22" seat depth N/A on chairs 043 & 163.
- 043 & 163 Chairs: with wood base (specify colour).

| Description                        | L x D x H     | Leather |                       |  |  |                                  |                           | Fabric |          |           |
|------------------------------------|---------------|---------|-----------------------|--|--|----------------------------------|---------------------------|--------|----------|-----------|
|                                    |               | 10      | 20<br>Madras<br>Softy | 30<br>Hugo<br>Fantasy<br>Illusion<br>Tucson<br>Utah<br>Vintage<br>Wild Laredo<br>Yukon | 40<br>Elegance<br>Princess<br>Santiago<br>Sensation<br>Sunset<br>Trina<br>Victoria | 50<br>Bull<br>Cassiope<br>Dublin | 60<br>Caress<br>Ultrasued | A      | B<br>COM | C<br>alta |
| 001 CHAIR                          | 46x40x33/40   | 1890    | 1980                  | 2070   | 2160   | 2250                             | 2340                      | 1535   | 1580     | 1625      |
| 002 LOVESEAT                       | 69x40x33/40   | 2700    | 2815                  | 2930   | 3045   | 3160                             | 3275                      | 2175   | 2250     | 2325      |
| 003 SOFA                           | 93x40x33/40   | 3265    | 3415                  | 3565   | 3715   | 3865                             | 4015                      | 2625   | 2715     | 2805      |
| 005 LOUNGE CHAIR RIGHT ARM         | 35x62x33/40   | 1765    | 1830                  | 1895   | 1960   | 2025                             | 2090                      | 1410   | 1470     | 1530      |
| 009 ARMLESS LOVESEAT               | 47x40x33/40   | 1895    | 1965                  | 2035   | 2105   | 2175                             | 2245                      | 1490   | 1570     | 1650      |
| 011 LOUNGE CHAIR LEFT ARM          | 35x62x33/40   | 1765    | 1830                  | 1895   | 1960   | 2025                             | 2090                      | 1410   | 1470     | 1530      |
| 012 LOVESEAT LEFT ARM              | 58x40x33/40   | 2320    | 2420                  | 2520   | 2620   | 2720                             | 2820                      | 1850   | 1925     | 2000      |
| 017 DOUBLE CHAIR                   | 53x40x33/40   | 1980    | 2080                  | 2180   | 2280   | 2380                             | 2480                      | 1600   | 1660     | 1720      |
| 021 APARTMENT SOFA NO ARM          | 61x40x33/40   | 2140    | 2240                  | 2340   | 2440   | 2540                             | 2640                      | 1670   | 1755     | 1840      |
| 040 ARMLESS SOFA                   | 71x40x33/40   | 2450    | 2565                  | 2680   | 2795   | 2910                             | 3025                      | 1950   | 2040     | 2130      |
| 041 RECLINING CHAIR LEFT ARM       | 35x40x33/40   | 1885    | 1960                  | 2035   | 2110   | 2185                             | 2260                      | 1605   | 1640     | 1675      |
| 042 RECLINING CHAIR RIGHT ARM      | 35x40x33/40   | 1885    | 1960                  | 2035   | 2110   | 2185                             | 2260                      | 1605   | 1640     | 1675      |
| 043 SWIVEL ROCKING RECLINING CHAIR | 30x34x42      | 2235    | 2345                  | 2455   | 2565   | 2675                             | 2785                      | 1875   | 1920     | 1965      |
| 044 RECLINER CHAIR                 | 46x40x33/40   | 2275    | 2365                  | 2455   | 2545   | 2635                             | 2725                      | 1920   | 1970     | 2020      |
| 045 ARMLESS LOVESEAT BUMPER RIGHT  | 68x40x33/40   | 2245    | 2340                  | 2435   | 2530   | 2625                             | 2720                      | 1785   | 1850     | 1915      |
| 050 WEDGE                          | 49X49X33      | 1645    | 1745                  | 1845   | 1945   | 2045                             | 2145                      | 1210   | 1270     | 1330      |
| 051 ARMLESS CHAIR                  | 23,5x40x33/40 | 1085    | 1135                  | 1185   | 1235   | 1285                             | 1335                      | 845    | 900      | 955       |
| 052 SOFA LEFT ARM                  | 82x40x33/40   | 2870    | 3005                  | 3140   | 3275   | 3410                             | 3545                      | 2290   | 2385     | 2480      |
| 053 SOFA RIGHT ARM                 | 82x40x33/40   | 2870    | 3005                  | 3140   | 3275   | 3410                             | 3545                      | 2290   | 2385     | 2480      |

## VENICE

### FEATURES:

- Manual adjustable headrest on all items (2 on square corner & stationary on wedge).
- \*Wall hugger power recliners with full footrest (manual n/a).
- Power recliner lounge chair (manual n/a) with power headrest in option. Wall clearance 8" & front 5".
- Seat cushions with shaped foam + 1" layer of memory foam on top; arm with memory foam.
- Stitching: Small thread in fabric & large flat thread in leather.
- \*Excludes 043 & 163 chairs: Wall clearance 16"

Note: 2 recliner seats separated by a corner can not be opened at the same time. No recliner seats beside item #155.

### OPTIONS

- Battery Pack: Add \$160/ea.
- \*Motorized headrest: Add \$160 ea. (\*N/A on stationary items).
- Foam: Extra firm add \$15/seat.
- Choice of Large or Small 6" Arm: Leg on LARGE arm: LG106 wood or LG189 metal (Black or Chrome). SMALL Arm: LG195 wood or LG196 metal (Black or Chrome). Specify colour.
- Seat Depth: 20" or \*22". \*22" seat depth N/A on chairs 043 & 163.
- 043 & 163 Chairs: with wood base (specify colour).

| Description                            | L x D x H     | Leather |                       |  |  |                                  |                           | Fabric |          |           |
|--|---------------|---------|-----------------------|--|--|----------------------------------|---------------------------|--------|----------|-----------|
|  |               | 10      | 20<br>Madras<br>Softy | 30<br>Hugo<br>Fantasy<br>Illusion<br>Tucson<br>Utah<br>Vintage<br>Wild Laredo<br>Yukon | 40<br>Elegance<br>Princess<br>Santiago<br>Sensation<br>Sunset<br>Trina<br>Victoria | 50<br>Bull<br>Cassiope<br>Dublin | 60<br>Caress<br>Ultrasued | A      | B<br>COM | C<br>alta |
| 055 SQUARE CORNER                      | 44x44x33/40   | 1915    | 2010                  | 2105   | 2200   | 2295                             | 2390                      | 1510   | 1565     | 1620      |
| 056 CHAIR RIGHT ARM                    | 35x40x33/40   | 1510    | 1575                  | 1640   | 1705   | 1770                             | 1835                      | 1200   | 1260     | 1320      |
| 057 CHAIR LEFT ARM                     | 35x40x33/40   | 1510    | 1575                  | 1640   | 1705   | 1770                             | 1835                      | 1200   | 1260     | 1320      |
| 061 LOVESEAT RIGHT ARM                 | 58x40x33/40   | 2320    | 2420                  | 2520   | 2620   | 2720                             | 2820                      | 1850   | 1925     | 2000      |
| 071 ARMLESS RECLINING CHAIR            | 23,5x40x33/40 | 1470    | 1525                  | 1580   | 1635   | 1690                             | 1745                      | 1250   | 1310     | 1370      |
| 086 ARMLESS LOVESEAT BUMPER LEFT       | 68x40x33/40   | 2245    | 2340                  | 2435   | 2530   | 2625                             | 2720                      | 1785   | 1850     | 1915      |
| 088 ARMLESS CHAIR BUMPER LEFT          | 45x40x33/40   | 1440    | 1535                  | 1630   | 1725   | 1820                             | 1915                      | 1130   | 1165     | 1200      |
| 089 ARMLESS CHAIR BUMPER RIGHT         | 45x40x33/40   | 1440    | 1535                  | 1630   | 1725   | 1820                             | 1915                      | 1130   | 1165     | 1200      |
| 095 APARTMENT SOFA                     | 83x40x33/40   | 2940    | 3085                  | 3230   | 3375   | 3520                             | 3665                      | 2350   | 2445     | 2540      |
| 096 APARTMENT SOFA LEFT ARM            | 72x40x33/40   | 2570    | 2680                  | 2790   | 2900   | 3010                             | 3120                      | 2020   | 2110     | 2200      |
| 097 APARTMENT SOFA RIGHT ARM           | 72x40x33/40   | 2570    | 2680                  | 2790   | 2900   | 3010                             | 3120                      | 2020   | 2110     | 2200      |
| 124 STORAGE OTTOMAN                    | 30x22x17      | 745     | 765                   | 785  | 805  | 825                              | 845                       | 650    | 670      | 690       |
| 155 SMALL SQUARE CORNER                | 40x40x33/40   | 1915    | 2010                  | 2105   | 2200   | 2295                             | 2390                      | 1510   | 1565     | 1620      |
| 163 DBL SWIVEL ROCKING RECLINER CHAIR  | 33x34x42      | 2290    | 2410                  | 2530   | 2650   | 2770                             | 2890                      | 1880   | 1930     | 1980      |
| 165 DOUBLE RECLINING CHAIR             | 53x40x33/40   | 2375    | 2475                  | 2575   | 2675   | 2775                             | 2875                      | 2000   | 2065     | 2130      |
| 167 APARTMENT SOFA NO ARM BUMPER LEFT  | 82x40x33/40   | 2490    | 2620                  | 2750   | 2880   | 3010                             | 3140                      | 1960   | 2045     | 2130      |
| 168 APARTMENT SOFA NO ARM BUMPER RIGHT | 82x40x33/40   | 2490    | 2620                  | 2750   | 2880   | 3010                             | 3140                      | 1960   | 2045     | 2130      |
| 169 DOUBLE RECLINING CHAIR LEFT ARM    | 42x40x33/40   | 1990    | 2070                  | 2150   | 2230   | 2310                             | 2390                      | 1670   | 1750     | 1830      |
| 170 DOUBLE RECLINING CHAIR RIGHT ARM   | 42x40x33/40   | 1990    | 2070                  | 2150   | 2230   | 2310                             | 2390                      | 1670   | 1750     | 1830      |
| 171 ARMLESS DOUBLE RECLINING CHAIR     | 30,5x40x33/40 | 1575    | 1625                  | 1675   | 1725   | 1775                             | 1825                      | 1320   | 1380     | 1440      |

## VENICE

### FEATURES:

- Manual adjustable headrest on all items (2 on square corner & stationary on wedge).
- \*Wall hugger power recliners with full footrest (manual n/a).
- Power recliner lounge chair (manual n/a) with power headrest in option. Wall clearance 8" & front 5".
- Seat cushions with shaped foam + 1" layer of memory foam on top; arm with memory foam.
- Stitching: Small thread in fabric & large flat thread in leather.
- \*Excludes 043 & 163 chairs: Wall clearance 16"

Note: 2 recliner seats separated by a corner can not be opened at the same time. No recliner seats beside item #155.

### OPTIONS

- Battery Pack: Add \$160/ea.
- \*Motorized headrest: Add \$160 ea. (\*N/A on stationary items).
- Foam: Extra firm add \$15/seat.
- Choice of Large or Small 6" Arm: Leg on LARGE arm: LG106 wood or LG189 metal (Black or Chrome). SMALL Arm: LG195 wood or LG196 metal (Black or Chrome). Specify colour.
- Seat Depth: 20" or \*22". \*22" seat depth N/A on chairs 043 & 163.
- 043 & 163 Chairs: with wood base (specify colour).

| Description                            | L x D x H     | Leather |                       |  |  |                                  |                           | Fabric |          |           |
|--|---------------|---------|-----------------------|--|--|----------------------------------|---------------------------|--------|----------|-----------|
|  |               | 10      | 20<br>Madras<br>Softy | 30<br>Hugo<br>Fantasy<br>Illusion<br>Tucson<br>Utah<br>Vintage<br>Wild Laredo<br>Yukon | 40<br>Elegance<br>Princess<br>Santiago<br>Sensation<br>Sunset<br>Trina<br>Victoria | 50<br>Bull<br>Cassiope<br>Dublin | 60<br>Caress<br>Ultrasued | A      | B<br>COM | C<br>alta |
| 173 DOUBLE LOUNGE CHAIR LEFT ARM       | 42x62x33/40   | 1915    | 2005                  | 2095   | 2185   | 2275                             | 2365                      | 1535   | 1615     | 1695      |
| 174 DOUBLE LOUNGE CHAIR RIGHT ARM      | 42x62x33/40   | 1915    | 2005                  | 2095   | 2185   | 2275                             | 2365                      | 1535   | 1615     | 1695      |
| 175 DOUBLE CHAIR LEFT ARM              | 42x40x33/40   | 1590    | 1680                  | 1770   | 1860   | 1950                             | 2040                      | 1285   | 1350     | 1415      |
| 176 DOUBLE CHAIR RIGHT ARM             | 42x40x33/40   | 1590    | 1680                  | 1770   | 1860   | 1950                             | 2040                      | 1285   | 1350     | 1415      |
| 177 ARMLESS DOUBLE CHAIR               | 30,5x40x33/40 | 1185    | 1250                  | 1315   | 1380   | 1445                             | 1510                      | 915    | 970      | 1025      |
| 178 ARMLESS DOUBLE CHAIR BUMPER LEFT   | 52x40x33/40   | 1545    | 1625                  | 1705   | 1785   | 1865                             | 1945                      | 1230   | 1290     | 1350      |
| 179 ARMLESS DOUBLE CHAIR BUMPER RIGHT  | 52x40x33/40   | 1545    | 1625                  | 1705   | 1785   | 1865                             | 1945                      | 1230   | 1290     | 1350      |
| 186 ARMLESS LOVESEAT BUMPER STORAGE-L  | 68x40x33/40   | 2420    | 2500                  | 2580   | 2660   | 2740                             | 2820                      | 1950   | 2015     | 2080      |
| 187 ARMLESS LOVESEAT BUMPER STORAGE-R  | 68x40x33/40   | 2420    | 2500                  | 2580   | 2660   | 2740                             | 2820                      | 1950   | 2015     | 2080      |
| 188 ARMLESS CHAIR BUMPER STORAGE-L     | 45x40x33/40   | 1600    | 1690                  | 1780   | 1870   | 1960                             | 2050                      | 1295   | 1330     | 1365      |
| 189 ARMLESS CHAIR BUMPER STORAGE-R     | 45x40x33/40   | 1600    | 1690                  | 1780   | 1870   | 1960                             | 2050                      | 1295   | 1330     | 1365      |
| 221 ARMLESS DBL CHAIR BUMPER STORAGE-L | 52x40x33/40   | 1705    | 1790                  | 1875   | 1960   | 2045                             | 2130                      | 1390   | 1450     | 1510      |
| 222 ARMLESS DBL CHAIR BUMPER STORAGE-R | 52x40x33/40   | 1705    | 1790                  | 1875   | 1960   | 2045                             | 2130                      | 1390   | 1450     | 1510      |
| 223 APT SOFA NO ARM BUMPER STORAGE-L   | 82x40x33/40   | 2655    | 2785                  | 2915   | 3045   | 3175                             | 3305                      | 2120   | 2215     | 2310      |
| 224 APT SOFA NO ARM BUMPER STORAGE-R   | 82x40x33/40   | 2655    | 2785                  | 2915   | 3045   | 3175                             | 3305                      | 2120   | 2215     | 2310      |
| 236 RECLINING LOUNGE CHAIR LEFT ARM    | 35x62x33/40   | 2160    | 2225                  | 2290   | 2355   | 2420                             | 2485                      | 1820   | 1880     | 1940      |
| 237 RECLINING LOUNGE CHAIR RIGHT ARM   | 35x62x33/40   | 2160    | 2225                  | 2290   | 2355   | 2420                             | 2485                      | 1820   | 1880     | 1940      |
| 238 RECLINING DBL LOUNGE CHAIR L-ARM   | 42x62x33/40   | 2315    | 2405                  | 2495   | 2585   | 2675                             | 2765                      | 1940   | 2020     | 2100      |
| 239 RECLINING DBL LOUNGE CHAIR R-ARM   | 42x62x33/40   | 2315    | 2405                  | 2495   | 2585   | 2675                             | 2765                      | 1940   | 2020     | 2100      |
| <b>CONFIGURATIONS</b>                  |               |         |                       |  |  |                                  |                           |        |          |           |

## CDN Price List

### VENICE

| Description                | L x D x H  | Leather |                       |  |  |                                  |                           | Fabric |          |           |
|----------------------------|------------|---------|-----------------------|--|--|----------------------------------|---------------------------|--------|----------|-----------|
|                            |            | 10      | 20<br>Madras<br>Softy | 30<br>Hugo<br>Fantasy<br>Illusion<br>Tucson<br>Utah<br>Vintage<br>Wild Laredo<br>Yukon | 40<br>Elegance<br>Princess<br>Santiago<br>Sensation<br>Sunset<br>Trina<br>Victoria | 50<br>Bull<br>Cassiope<br>Dublin | 60<br>Caress<br>Ultrasued | A      | B<br>COM | C<br>alta |
| A CONFIG (169-170)         | 84X40X40   | 3980    | 4140                  | 4300   | 4460   | 4620                             | 4780                      | 3340   | 3500     | 3660      |
| B CONFIG (169-171-174)     | 115X62X40  | 5480    | 5700                  | 5920   | 6140   | 6360                             | 6580                      | 4525   | 4745     | 4965      |
| C CONFIG (096-055-171-170) | 116X116X40 | 8050    | 8385                  | 8720   | 9055   | 9390                             | 9725                      | 6520   | 6805     | 7090      |
| D CONFIG (169-171-055-179) | 116X96X40  | 7025    | 7330                  | 7635   | 7940   | 8245                             | 8550                      | 5730   | 5985     | 6240      |
| J CONFIG (041-042)         | 70X40X40   | 3770    | 3920                  | 4070   | 4220   | 4370                             | 4520                      | 3210   | 3280     | 3350      |
| K CONFIG (041-071-005)     | 94X62X40   | 5120    | 5315                  | 5510   | 5705   | 5900                             | 6095                      | 4265   | 4420     | 4575      |
| L CONFIG (012-055-071-042) | 102X102X40 | 7590    | 7915                  | 8240   | 8565   | 8890                             | 9215                      | 6215   | 6440     | 6665      |
| M CONFIG (041-071-055-089) | 103X89X40  | 6710    | 7030                  | 7350   | 7670   | 7990                             | 8310                      | 5495   | 5680     | 5865      |



# VENICE

**OPTIMA**  
Collection

**Jaymar**

Conçu et fabriqué fièrement au Canada  
Proudly designed and made in Canada

Nos produits sont fabriqués à la main et des variations mineures peuvent survenir

Our product is hand-made and minor variations can occur.

## SPECIFICATIONS

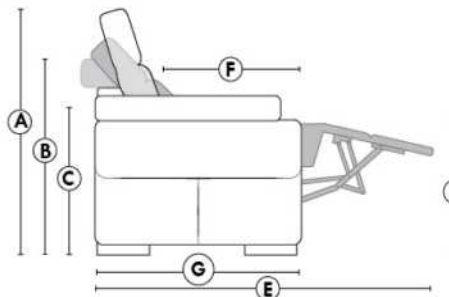

- Appui-tête levé / Headrest up
- Appui-tête baissé / Headrest down
- Complètement incliné / Fully reclined

- A** Hauteur complète 40" / Total Height
- B** Hauteur appui-tête baissé 33" / Height headrest down
- C** Hauteur du bras 22,5" / Arm Height
- D** Hauteur du siège 19,5" / Seat height
- E** Profondeur inclinée 65" / Depth fully reclined
- F** Profondeur d'assise 20" ou/ou 22" / Seat depth
- G** Profondeur appui-tête monté 37,5" / Depth with headrest up

## BRAS | ARMS

Option de bras:  
Bras Régulier Large 11" ou Petit bras 6"

Arm option  
Regular arm Large 11" or Small arm 6"

Contrôle de l'inclinaison situé à l'extérieur du bras  
Recliner control located on the outside of the arm.

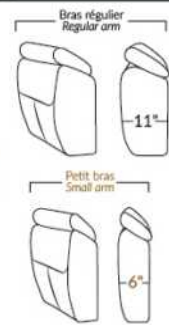

## FAUTEUIL BERÇANT PIVOTANT INCLINABLE SWIVEL ROCKING MOTION CHAIR

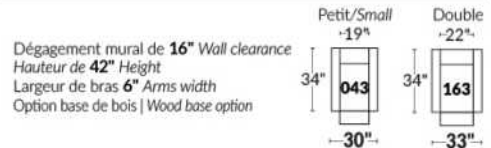

## SIÈGE 23" DE LARGE | 23" SEAT WIDTH

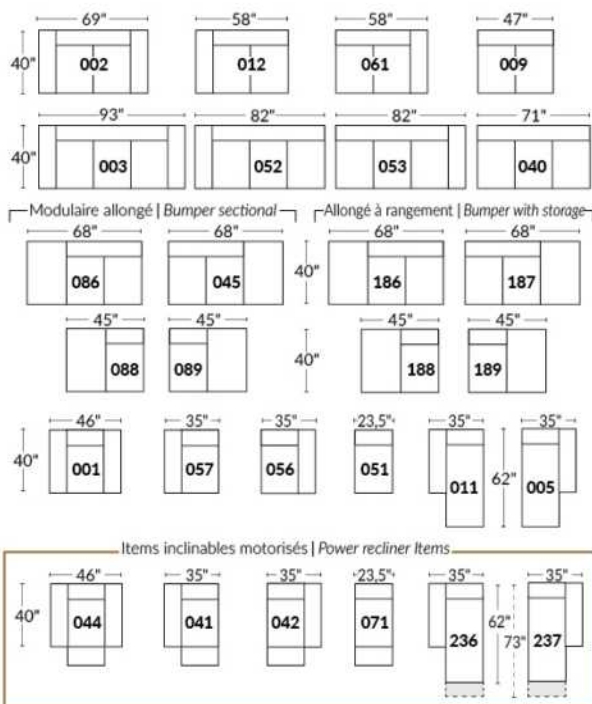

## SIÈGE 30" DE LARGE | 30" SEAT WIDTH

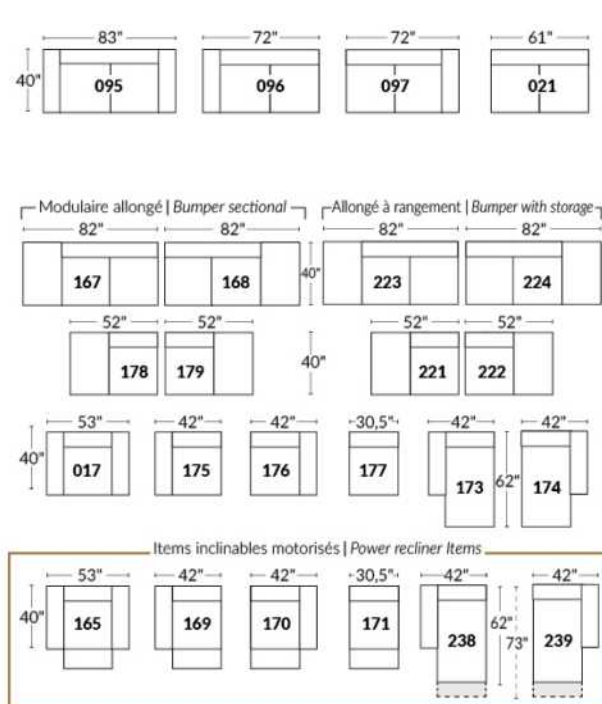

### Autres | Others

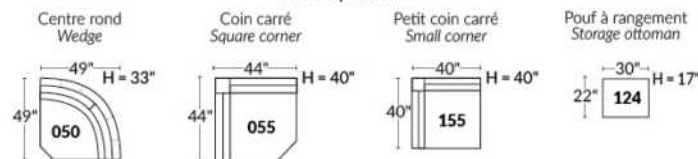

### EXEMPLE 23" EXAMPLE

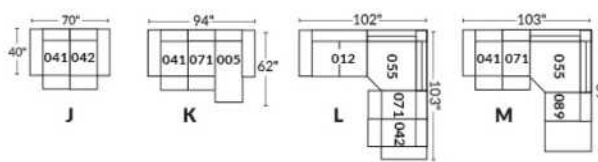

### EXEMPLE 30" EXAMPLE

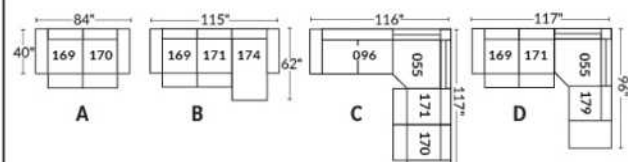

## WASHINGTON

### FEATURES:

- Manual adjustable headrest on all items (stationary on #050).
- \*Wall hugger power recliners with full footrest (manual n/a).
- Power recliner lounge chair (manual n/a) with power headrest in option. Wall clearance 8" & front 5".
- Seat cushions with shaped foam + 1" layer of memory foam on top.
- Stitching: Small thread in fabric & large flat thread in leather.
- \*Excludes chairs 043 & 163: Wall clearance 16".

Note: 2 recliner seats separated by a corner can not be opened at the same time. No recliner seats beside item #155.

### OPTIONS

Battery Pack: Add \$160/ea.

\*Motorized headrest:: Add \$160 ea. (\*N/A on stationary items).

Foam: Extra firm add \$15/seat.

Choice of Large or Small 6" Arm (specify): LARGE & SMALL Arm Legs: LG195 wood or LG196 metal (Black or Chrome). Specify colour.

Seat Depth: 20" or \*22". \*22" seat depth N/A on chairs 043 & 163.

043 & 163 Chairs: with wood base (specify colour).

Nails on front arm: add \$30/arm. Specify colour & size: 5/8" nails (#54) Antique or 1/2" or 7/8" nails, colors: Brass-Silver-Pewter or Copper.

| Description                        | L x D x H         | Leather |                       |  |  |                                  |                           | Fabric |          |           |
|------------------------------------|-------------------|---------|-----------------------|--|--|----------------------------------|---------------------------|--------|----------|-----------|
|                                    |                   | 10      | 20<br>Madras<br>Softy | 30<br>Hugo<br>Fantasy<br>Illusion<br>Tucson<br>Utah<br>Vintage<br>Wild Laredo<br>Yukon | 40<br>Elegance<br>Princess<br>Santiago<br>Sensation<br>Sunset<br>Trina<br>Victoria | 50<br>Bull<br>Cassiope<br>Dublin | 60<br>Caress<br>Ultrasued | A      | B<br>COM | C<br>alta |
| 001 CHAIR                          | 45 x 40 x 33/40   | 1890    | 1980                  | 2070   | 2160   | 2250                             | 2340                      | 1535   | 1580     | 1625      |
| 002 LOVESEAT                       | 68 x 40 x 33/40   | 2700    | 2815                  | 2930   | 3045   | 3160                             | 3275                      | 2175   | 2250     | 2325      |
| 003 SOFA                           | 92 x 40 x 33/40   | 3265    | 3415                  | 3565   | 3715   | 3865                             | 4015                      | 2625   | 2715     | 2805      |
| 005 LOUNGE CHAIR RIGHT ARM         | 35 x 62 x 33/40   | 1765    | 1830                  | 1895   | 1960   | 2025                             | 2090                      | 1410   | 1470     | 1530      |
| 009 ARMLESS LOVESEAT               | 47 x 40 x 33/40   | 1895    | 1965                  | 2035   | 2105   | 2175                             | 2245                      | 1490   | 1570     | 1650      |
| 011 LOUNGE CHAIR LEFT ARM          | 35 x 62 x 33/40   | 1765    | 1830                  | 1895   | 1960   | 2025                             | 2090                      | 1410   | 1470     | 1530      |
| 012 LOVESEAT LEFT ARM              | 58 x 40 x 33/40   | 2320    | 2420                  | 2520   | 2620   | 2720                             | 2820                      | 1850   | 1925     | 2000      |
| 017 DOUBLE CHAIR                   | 52 x 40 x 33/40   | 1980    | 2080                  | 2180   | 2280   | 2380                             | 2480                      | 1600   | 1660     | 1720      |
| 021 APARTMENT SOFA NO ARM          | 61 x 40 x 33/40   | 2140    | 2240                  | 2340   | 2440   | 2540                             | 2640                      | 1670   | 1755     | 1840      |
| 040 ARMLESS SOFA                   | 71 x 40 x 33/40   | 2450    | 2565                  | 2680   | 2795   | 2910                             | 3025                      | 1950   | 2040     | 2130      |
| 041 RECLINING CHAIR LEFT ARM       | 35 x 40 x 33/40   | 1885    | 1960                  | 2035   | 2110   | 2185                             | 2260                      | 1605   | 1640     | 1675      |
| 042 RECLINING CHAIR RIGHT ARM      | 35 x 40 x 33/40   | 1885    | 1960                  | 2035   | 2110   | 2185                             | 2260                      | 1605   | 1640     | 1675      |
| 043 SWIVEL ROCKING RECLINING CHAIR | 30 x 34 x 42      | 2235    | 2345                  | 2455   | 2565   | 2675                             | 2785                      | 1875   | 1920     | 1965      |
| 044 RECLINER CHAIR                 | 45 x 40 x 33/40   | 2275    | 2365                  | 2455   | 2545   | 2635                             | 2725                      | 1920   | 1970     | 2020      |
| 045 ARMLESS LOVESEAT BUMPER RIGHT  | 68 x 40 x 33/40   | 2245    | 2340                  | 2435   | 2530   | 2625                             | 2720                      | 1785   | 1850     | 1915      |
| 050 WEDGE                          | 49 x 49 x 33      | 1645    | 1745                  | 1845   | 1945   | 2045                             | 2145                      | 1210   | 1270     | 1330      |
| 051 ARMLESS CHAIR                  | 23,5 x 40 x 33/40 | 1085    | 1135                  | 1185   | 1235   | 1285                             | 1335                      | 845    | 900      | 955       |
| 052 SOFA LEFT ARM                  | 82 x 40 x 33/40   | 2870    | 3005                  | 3140   | 3275   | 3410                             | 3545                      | 2290   | 2385     | 2480      |
| 053 SOFA RIGHT ARM                 | 82 x 40 x 33/40   | 2870    | 3005                  | 3140   | 3275   | 3410                             | 3545                      | 2290   | 2385     | 2480      |



## WASHINGTON

### FEATURES:

- Manual adjustable headrest on all items (stationary on #050).
- \*Wall hugger power recliners with full footrest (manual n/a).
- Power recliner lounge chair (manual n/a) with power headrest in option. Wall clearance 8" & front 5".
- Seat cushions with shaped foam + 1" layer of memory foam on top.
- Stitching: Small thread in fabric & large flat thread in leather.
- \*Excludes chairs 043 & 163: Wall clearance 16".

Note: 2 recliner seats separated by a corner can not be opened at the same time. No recliner seats beside item #155.

### OPTIONS

Battery Pack: Add \$160/ea.

\*Motorized headrest:: Add \$160 ea. (\*N/A on stationary items).

Foam: Extra firm add \$15/seat.

Choice of Large or Small 6" Arm (specify): LARGE & SMALL Arm Legs: LG195 wood or LG196 metal (Black or Chrome). Specify colour.

Seat Depth: 20" or \*22". \*22" seat depth N/A on chairs 043 & 163.

043 & 163 Chairs: with wood base (specify colour).

Nails on front arm: add \$30/arm. Specify colour & size: 5/8" nails (#54) Antique or 1/2" or 7/8" nails, colors: Brass-Silver-Pewter or Copper.

| Description                            | L x D x H         | Leather |                       |  |  |                                  |                           | Fabric |          |           |
|--|-------------------|---------|-----------------------|--|--|----------------------------------|---------------------------|--------|----------|-----------|
|  |                   | 10      | 20<br>Madras<br>Softy | 30<br>Hugo<br>Fantasy<br>Illusion<br>Tucson<br>Utah<br>Vintage<br>Wild Laredo<br>Yukon | 40<br>Elegance<br>Princess<br>Santiago<br>Sensation<br>Sunset<br>Trina<br>Victoria | 50<br>Bull<br>Cassiope<br>Dublin | 60<br>Caress<br>Ultrasued | A      | B<br>COM | C<br>alta |
| 055 SQUARE CORNER                      | 44 x 44 x 33/40   | 1915    | 2010                  | 2105   | 2200   | 2295                             | 2390                      | 1510   | 1565     | 1620      |
| 056 CHAIR RIGHT ARM                    | 35 x 40 x 33/40   | 1510    | 1575                  | 1640   | 1705   | 1770                             | 1835                      | 1200   | 1260     | 1320      |
| 057 CHAIR LEFT ARM                     | 35 x 40 x 33/40   | 1510    | 1575                  | 1640   | 1705   | 1770                             | 1835                      | 1200   | 1260     | 1320      |
| 061 LOVESEAT RIGHT ARM                 | 58 x 40 x 33/40   | 2320    | 2420                  | 2520   | 2620   | 2720                             | 2820                      | 1850   | 1925     | 2000      |
| 071 ARMLESS RECLINING CHAIR            | 23,5 x 40 x 33/40 | 1470    | 1525                  | 1580   | 1635   | 1690                             | 1745                      | 1250   | 1310     | 1370      |
| 086 ARMLESS LOVESEAT BUMPER LEFT       | 68 x 40 x 33/40   | 2245    | 2340                  | 2435   | 2530   | 2625                             | 2720                      | 1785   | 1850     | 1915      |
| 088 ARMLESS CHAIR BUMPER LEFT          | 45 x 40 x 33/40   | 1440    | 1535                  | 1630   | 1725   | 1820                             | 1915                      | 1130   | 1165     | 1200      |
| 089 ARMLESS CHAIR BUMPER RIGHT         | 45 x 40 x 33/40   | 1440    | 1535                  | 1630   | 1725   | 1820                             | 1915                      | 1130   | 1165     | 1200      |
| 095 APARTMENT SOFA                     | 82 x 40 x 33/40   | 2940    | 3085                  | 3230   | 3375   | 3520                             | 3665                      | 2350   | 2445     | 2540      |
| 096 APARTMENT SOFA LEFT ARM            | 72 x 40 x 33/40   | 2570    | 2680                  | 2790   | 2900   | 3010                             | 3120                      | 2020   | 2110     | 2200      |
| 097 APARTMENT SOFA RIGHT ARM           | 72 x 40 x 33/40   | 2570    | 2680                  | 2790   | 2900   | 3010                             | 3120                      | 2020   | 2110     | 2200      |
| 124 STORAGE OTTOMAN                    | 30 x 22 x 17      | 745     | 765                   | 785  | 805  | 825                              | 845                       | 650    | 670      | 690       |
| 155 SMALL SQUARE CORNER                | 40x40x33/40       | 1915    | 2010                  | 2105   | 2200   | 2295                             | 2390                      | 1510   | 1565     | 1620      |
| 163 DBL SWIVEL ROCKING RECLINER CHAIR  | 33 x 34 x 42      | 2290    | 2410                  | 2530   | 2650   | 2770                             | 2890                      | 1880   | 1930     | 1980      |
| 165 DOUBLE RECLINING CHAIR             | 52 x 40 x 33/40   | 2375    | 2475                  | 2575   | 2675   | 2775                             | 2875                      | 2000   | 2065     | 2130      |
| 167 APARTMENT SOFA NO ARM BUMPER LEFT  | 82 x 40 x 33/40   | 2490    | 2620                  | 2750   | 2880   | 3010                             | 3140                      | 1960   | 2045     | 2130      |
| 168 APARTMENT SOFA NO ARM BUMPER RIGHT | 82 x 40 x 33/40   | 2490    | 2620                  | 2750   | 2880   | 3010                             | 3140                      | 1960   | 2045     | 2130      |
| 169 DOUBLE RECLINING CHAIR LEFT ARM    | 42 x 40 x 33/40   | 1990    | 2070                  | 2150   | 2230   | 2310                             | 2390                      | 1670   | 1750     | 1830      |
| 170 DOUBLE RECLINING CHAIR RIGHT ARM   | 42 x 40 x 33/40   | 1990    | 2070                  | 2150   | 2230   | 2310                             | 2390                      | 1670   | 1750     | 1830      |
| 171 ARMLESS DOUBLE RECLINING CHAIR     | 30,5 x 40 x 33/40 | 1575    | 1625                  | 1675   | 1725   | 1775                             | 1825                      | 1320   | 1380     | 1440      |

## WASHINGTON

### FEATURES:

- Manual adjustable headrest on all items (stationary on #050).
- \*Wall hugger power recliners with full footrest (manual n/a).
- Power recliner lounge chair (manual n/a) with power headrest in option. Wall clearance 8" & front 5".
- Seat cushions with shaped foam + 1" layer of memory foam on top.
- Stitching: Small thread in fabric & large flat thread in leather.
- \*Excludes chairs 043 & 163: Wall clearance 16".

Note: 2 recliner seats separated by a corner can not be opened at the same time. No recliner seats beside item #155.

### OPTIONS

Battery Pack: Add \$160/ea.

\*Motorized headrest:: Add \$160 ea. (\*N/A on stationary items).

Foam: Extra firm add \$15/seat.

Choice of Large or Small 6" Arm (specify): LARGE & SMALL Arm Legs: LG195 wood or LG196 metal (Black or Chrome). Specify colour.

Seat Depth: 20" or \*22". \*22" seat depth N/A on chairs 043 & 163.

043 & 163 Chairs: with wood base (specify colour).

Nails on front arm: add \$30/arm. Specify colour & size: 5/8" nails (#54) Antique or 1/2" or 7/8" nails, colors: Brass-Silver-Pewter or Copper.

| Description                            | L x D x H         | Leather |                       |  |  |                                  |                           | Fabric |          |           |
|--|-------------------|---------|-----------------------|--|--|----------------------------------|---------------------------|--------|----------|-----------|
|  |                   | 10      | 20<br>Madras<br>Softy | 30<br>Hugo<br>Fantasy<br>Illusion<br>Tucson<br>Utah<br>Vintage<br>Wild Laredo<br>Yukon | 40<br>Elegance<br>Princess<br>Santiago<br>Sensation<br>Sunset<br>Trina<br>Victoria | 50<br>Bull<br>Cassiope<br>Dublin | 60<br>Caress<br>Ultrasued | A      | B<br>COM | C<br>alta |
| 173 DOUBLE LOUNGE CHAIR LEFT ARM       | 42 x 62 x 33/40   | 1915    | 2005                  | 2095   | 2185   | 2275                             | 2365                      | 1535   | 1615     | 1695      |
| 174 DOUBLE LOUNGE CHAIR RIGHT ARM      | 42 x 62 x 33/40   | 1915    | 2005                  | 2095   | 2185   | 2275                             | 2365                      | 1535   | 1615     | 1695      |
| 175 DOUBLE CHAIR LEFT ARM              | 42 x 40 x 33/40   | 1590    | 1680                  | 1770   | 1860   | 1950                             | 2040                      | 1285   | 1350     | 1415      |
| 176 DOUBLE CHAIR RIGHT ARM             | 42 x 40 x 33/40   | 1590    | 1680                  | 1770   | 1860   | 1950                             | 2040                      | 1285   | 1350     | 1415      |
| 177 ARMLESS DOUBLE CHAIR               | 30,5 x 40 x 33/40 | 1185    | 1250                  | 1315   | 1380   | 1445                             | 1510                      | 915    | 970      | 1025      |
| 178 ARMLESS DOUBLE CHAIR BUMPER LEFT   | 52 x 40 x 33/40   | 1545    | 1625                  | 1705   | 1785   | 1865                             | 1945                      | 1230   | 1290     | 1350      |
| 179 ARMLESS DOUBLE CHAIR BUMPER RIGHT  | 52 x 40 x 33/40   | 1545    | 1625                  | 1705   | 1785   | 1865                             | 1945                      | 1230   | 1290     | 1350      |
| 186 ARMLESS LOVESEAT BUMPER STORAGE-L  | 68 x 40 x 33/40   | 2420    | 2500                  | 2580   | 2660   | 2740                             | 2820                      | 1950   | 2015     | 2080      |
| 187 ARMLESS LOVESEAT BUMPER STORAGE-R  | 68 x 40 x 33/40   | 2420    | 2500                  | 2580   | 2660   | 2740                             | 2820                      | 1950   | 2015     | 2080      |
| 188 ARMLESS CHAIR BUMPER STORAGE-L     | 45 x 40 x 33/40   | 1600    | 1690                  | 1780   | 1870   | 1960                             | 2050                      | 1295   | 1330     | 1365      |
| 189 ARMLESS CHAIR BUMPER STORAGE-R     | 45 x 40 x 33/40   | 1600    | 1690                  | 1780   | 1870   | 1960                             | 2050                      | 1295   | 1330     | 1365      |
| 221 ARMLESS DBL CHAIR BUMPER STORAGE-L | 52 x 40 x 33/40   | 1705    | 1790                  | 1875   | 1960   | 2045                             | 2130                      | 1390   | 1450     | 1510      |
| 222 ARMLESS DBL CHAIR BUMPER STORAGE-R | 52 x 40 x 33/40   | 1705    | 1790                  | 1875   | 1960   | 2045                             | 2130                      | 1390   | 1450     | 1510      |
| 223 APT SOFA NO ARM BUMPER STORAGE-L   | 82 x 40 x 33/40   | 2655    | 2785                  | 2915   | 3045   | 3175                             | 3305                      | 2120   | 2215     | 2310      |
| 224 APT SOFA NO ARM BUMPER STORAGE-R   | 82 x 40 x 33/40   | 2655    | 2785                  | 2915   | 3045   | 3175                             | 3305                      | 2120   | 2215     | 2310      |
| 236 RECLINING LOUNGE CHAIR LEFT ARM    | 35 x 62 x 33/40   | 2160    | 2225                  | 2290   | 2355   | 2420                             | 2485                      | 1820   | 1880     | 1940      |
| 237 RECLINING LOUNGE CHAIR RIGHT ARM   | 35 x 62 x 33/40   | 2160    | 2225                  | 2290   | 2355   | 2420                             | 2485                      | 1820   | 1880     | 1940      |
| 238 RECLINING DBL LOUNGE CHAIR L-ARM   | 42 x 62 x 33/40   | 2315    | 2405                  | 2495   | 2585   | 2675                             | 2765                      | 1940   | 2020     | 2100      |
| 239 RECLINING DBL LOUNGE CHAIR R-ARM   | 42 x 62 x 33/40   | 2315    | 2405                  | 2495   | 2585   | 2675                             | 2765                      | 1940   | 2020     | 2100      |
| <b>CONFIGURATIONS</b>                  |                   |         |                       |  |  |                                  |                           |        |          |           |

## CDN Price List

### WASHINGTON

| Description                | L x D x H  | Leather |                       |  |  |                                  |                           | Fabric |          |           |
|----------------------------|------------|---------|-----------------------|--|--|----------------------------------|---------------------------|--------|----------|-----------|
|                            |            | 10      | 20<br>Madras<br>Softy | 30<br>Hugo<br>Fantasy<br>Illusion<br>Tucson<br>Utah<br>Vintage<br>Wild Laredo<br>Yukon | 40<br>Elegance<br>Princess<br>Santiago<br>Sensation<br>Sunset<br>Trina<br>Victoria | 50<br>Bull<br>Cassiope<br>Dublin | 60<br>Caress<br>Ultrasued | A      | B<br>COM | C<br>alta |
| A CONFIG (169-170)         | 84X40X40   | 3980    | 4140                  | 4300   | 4460   | 4620                             | 4780                      | 3340   | 3500     | 3660      |
| B CONFIG (169-171-174)     | 115X62X40  | 5480    | 5700                  | 5920   | 6140   | 6360                             | 6580                      | 4525   | 4745     | 4965      |
| C CONFIG (096-055-171-170) | 116X116X40 | 8050    | 8385                  | 8720   | 9055   | 9390                             | 9725                      | 6520   | 6805     | 7090      |
| D CONFIG (169-171-055-179) | 116X96X40  | 7025    | 7330                  | 7635   | 7940   | 8245                             | 8550                      | 5730   | 5985     | 6240      |
| J CONFIG (041-042)         | 70X40X40   | 3770    | 3920                  | 4070   | 4220   | 4370                             | 4520                      | 3210   | 3280     | 3350      |
| K CONFIG (041-071-005)     | 94X62X40   | 5120    | 5315                  | 5510   | 5705   | 5900                             | 6095                      | 4265   | 4420     | 4575      |
| L CONFIG (012-055-071-042) | 102-102X40 | 7590    | 7915                  | 8240   | 8565   | 8890                             | 9215                      | 6215   | 6440     | 6665      |
| M CONFIG (041-071-055-089) | 103X89X40  | 6710    | 7030                  | 7350   | 7670   | 7990                             | 8310                      | 5495   | 5680     | 5865      |



# WASHINGTON

**OPTIMA**  
Collection

**Jaymar**

Conçu et fabriqué fièrement au Canada  
Proudly designed and made in Canada

Nos produits sont fabriqués à la main et des variations mineures peuvent survenir

Our product is hand-made and minor variations can occur.

## SPECIFICATIONS

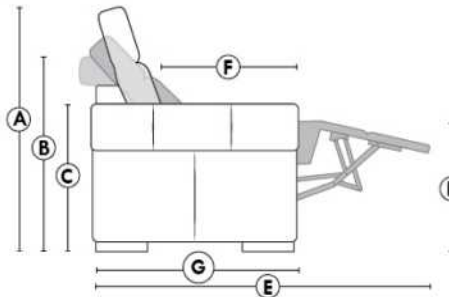

- Appui-tête levé / Headrest up
- Appui-tête baissé / Headrest down
- Complètement incliné / Fully reclined

- A** Hauteur complète 40" Total Height
- B** Hauteur appui-tête baissé 33" Height headrest down
- C** Hauteur du bras 24" Arm Height
- D** Hauteur du siège 19,5" Seat height
- E** Profondeur inclinée 65" Depth fully reclined
- F** Profondeur d'assise 20"ou/ou 22" Seat depth
- G** Profondeur appui-tête monté 37,5" Depth with headrest up

## BRAS | ARMS

Option de bras:  
Bras Régulier Large 10,5" ou Petit bras 6"

Arm option  
Regular arm Large 10,5" or Small arm 6"

Contrôle de l'inclinaison situé à l'intérieur du bras  
Recliner control located on the inside of the arm.

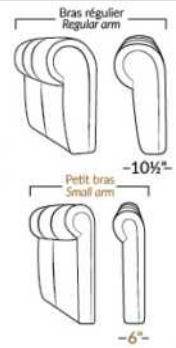

## FAUTEUIL BERÇANT PIVOTANT INCLINABLE SWIVEL ROCKING MOTION CHAIR



## SIÈGE 23" DE LARGE | 23" SEAT WIDTH

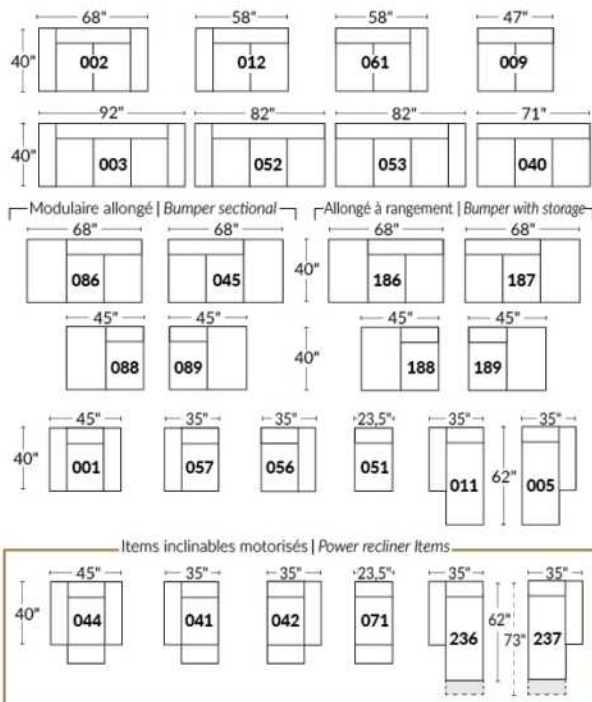

## SIÈGE 30" DE LARGE | 30" SEAT WIDTH

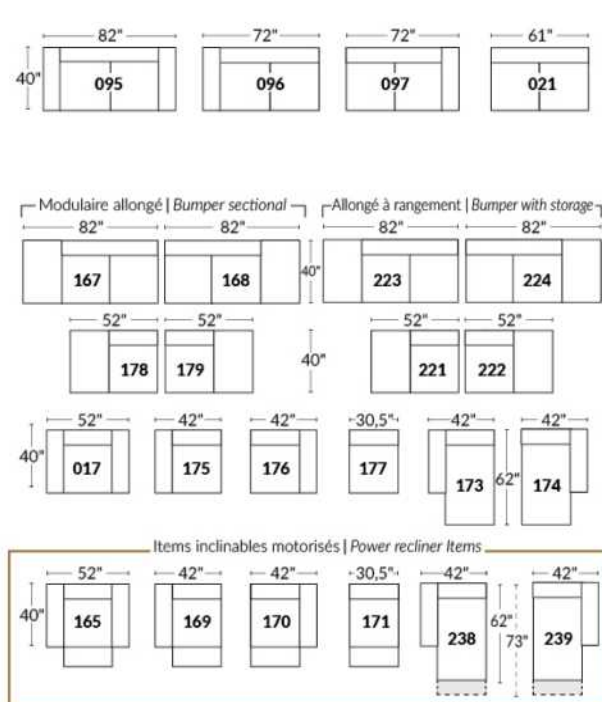

## Autres | Others

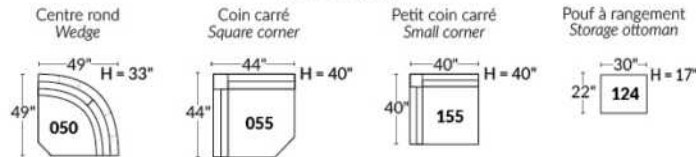

## EXEMPLE 23" EXAMPLE

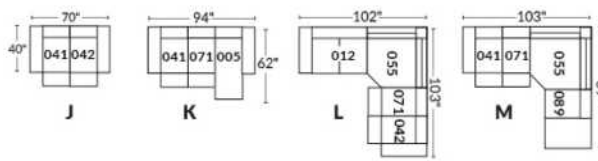

## EXEMPLE 30" EXAMPLE

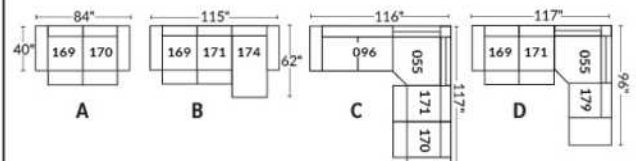

## CDN Price List

### WINDSOR

LEGS: Specify colour of legs LG3 round or LG4 square, BEECH finish not available for legs LG3.

COMBO: Cover #2 on back and seat.

FABRIC: There is no stitching on back cushions.

OPTION PIPING CRESTWOOD ON ARMS ONLY: Add \$60; Colour: Chestnut, Taupe or Sand.

NAIL OPTION ON ARMS AND BASE: Sofa: \$100 Loveseat: \$85 Chair: \$75 Ottoman: \$50.

| Description  | L x D x H    | Leather |                       |  |   |                                  |                           | Fabric |          |           |
|--------------|--------------|---------|-----------------------|--|---|----------------------------------|---------------------------|--------|----------|-----------|
|              |              | 10      | 20<br>Madras<br>Softy | 30<br>Hugo<br>Fantasy<br>Illusion<br>Tucson<br>Utah<br>Vintage<br>Wild Laredo<br>Yukon | 40<br>Elegance<br>Princess<br>Santiago<br>Sensation | 50<br>Bull<br>Cassiope<br>Dublin | 60<br>Caress<br>Ultrasued | A      | B<br>COM | C<br>alta |
| 001 CHAIR    | 42x37x37     | 1605    | 1700                  | 1795   | 1890  | 1985                             | 2080                      | 1100   | 1145     | 1190      |
| 002 LOVESEAT | 66x37x37     | 2290    | 2410                  | 2530   | 2650  | 2770                             | 2890                      | 1510   | 1590     | 1670      |
| 003 SOFA     | 89x37x37     | 2495    | 2665                  | 2835   | 3005  | 3175                             | 3345                      | 1750   | 1835     | 1920      |
| 006 OTTOMAN  | 25.5X25.5X18 | 685     | 710                   | 735  | 760   | 785                              | 810                       | 550    | 570      | 590       |

# WINDSOR



Hauteur de siège 19" | Hauteur devant bras 26" | Profondeur d'assise 20"  
Seat Height 19" | Arm Height 26" | Seat Depth 20"

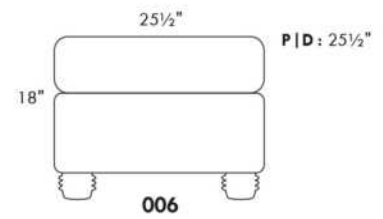
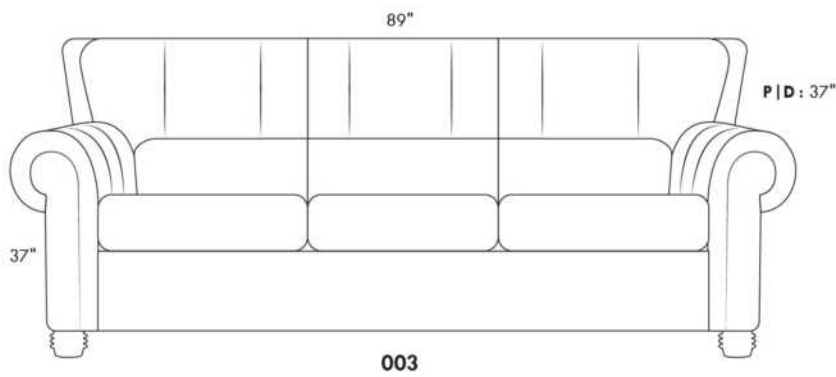
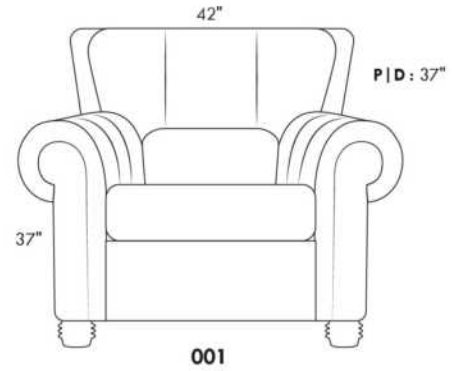
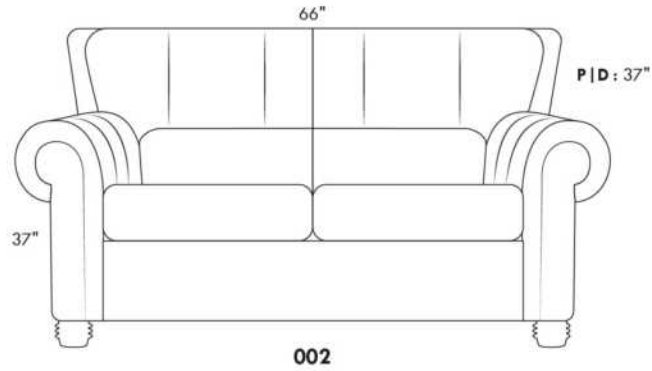

[www.jaymar.ca](http://www.jaymar.ca)

Toutes les dimensions indiquées sont au pouce près. Nos produits sont fabriqués à la main et des variations mineures peuvent survenir.  
All dimensions indicated are to the nearest inch. Our product is hand-made and minor variations can occur.

## CDN Price List

### WINSLOW

Specify colour of legs LG107.

IN LEATHER: Backs & Seats will have parallel decorative seams. Back cushions will be semi attached with a zipper.

SEAT cushions contain FEATHERS. Back & Seat cushions reversible.

COMBO #1: Cover #2 on backs & seats. PRICE: See "Product Knowledge" booklet.

COMBO #2: Cover #2 SEATS in LEATHER ONLY; Grade 10 to 30 add \$60 per seat cushion. Grade 40 to 60 add \$90 per seat cushion. Lounge = 2 seats.

| Description                    | L x D x H  | Leather |                       |  |  |                                  |                           | Fabric |          |           |
|--------------------------------|------------|---------|-----------------------|--|--|----------------------------------|---------------------------|--------|----------|-----------|
|                                |            | 10      | 20<br>Madras<br>Softy | 30<br>Hugo<br>Fantasy<br>Illusion<br>Tucson<br>Utah<br>Vintage<br>Wild Laredo<br>Yukon | 40<br>Elegance<br>Princess<br>Santiago<br>Sensation<br>Sunset<br>Trina<br>Victoria | 50<br>Bull<br>Cassiope<br>Dublin | 60<br>Caress<br>Ultrasued | A      | B<br>COM | C<br>alta |
| 002 LOVESEAT                   | 66X41X34   | 2320    | 2440                  | 2560   | 2680   | 2800                             | 2920                      | 1450   | 1555     | 1660      |
| 005 LOUNGE CHAIR RIGHT ARM     | 42X70X34   | 1985    | 2075                  | 2165   | 2255   | 2345                             | 2435                      | 1395   | 1480     | 1565      |
| 006 OTTOMAN                    | 35X24X17   | 720     | 745                   | 770  | 795  | 820                              | 845                       | 535    | 545      | 555       |
| 011 LOUNGE CHAIR LEFT ARM      | 42X70X34   | 1985    | 2075                  | 2165   | 2255   | 2345                             | 2435                      | 1395   | 1480     | 1565      |
| 017 DOUBLE CHAIR               | 49X41X34   | 1800    | 1910                  | 2020   | 2130   | 2240                             | 2350                      | 1235   | 1310     | 1385      |
| 021 APARTMENT SOFA NO ARM      | 70X41X34   | 2220    | 2355                  | 2490   | 2625   | 2760                             | 2895                      | 1660   | 1780     | 1900      |
| 051 ARMLESS CHAIR              | 35X41X34   | 1175    | 1270                  | 1365   | 1460   | 1555                             | 1650                      | 1095   | 1145     | 1195      |
| 055 SQUARE CORNER              | 45X45X34   | 1300    | 1355                  | 1410   | 1465   | 1520                             | 1575                      | 1095   | 1145     | 1195      |
| 056 CHAIR RIGHT ARM            | 42X41X34   | 1485    | 1585                  | 1685   | 1785   | 1885                             | 1985                      | 1150   | 1215     | 1280      |
| 057 CHAIR LEFT ARM             | 42X41X34   | 1485    | 1585                  | 1685   | 1785   | 1885                             | 1985                      | 1150   | 1215     | 1280      |
| 088 ARMLESS CHAIR BUMPER LEFT  | 56X41X34   | 1545    | 1630                  | 1715   | 1800   | 1885                             | 1970                      | 1170   | 1230     | 1290      |
| 089 ARMLESS CHAIR BUMPER RIGHT | 56X41X34   | 1545    | 1630                  | 1715   | 1800   | 1885                             | 1970                      | 1170   | 1230     | 1290      |
| 095 APARTMENT SOFA             | 84x41x34   | 2815    | 2955                  | 3095   | 3235   | 3375                             | 3515                      | 1850   | 1970     | 2090      |
| 096 APARTMENT SOFA LEFT ARM    | 77x41x34   | 2505    | 2660                  | 2815   | 2970   | 3125                             | 3280                      | 1770   | 1875     | 1980      |
| 097 APARTMENT SOFA RIGHT ARM   | 77x41x34   | 2505    | 2660                  | 2815   | 2970   | 3125                             | 3280                      | 1770   | 1875     | 1980      |
| <b>CONFIGURATIONS</b>          |            |         |                       |  |  |                                  |                           |        |          |           |
| A CONF. A (96-55-56)           | 122X87X34  | 5290    | 5600                  | 5910   | 6220   | 6530                             | 6840                      | 4015   | 4235     | 4455      |
| B CONF. B (88-55-89)           | 101X101X34 | 4390    | 4615                  | 4840   | 5065   | 5290                             | 5515                      | 3435   | 3605     | 3775      |
| C CONF. C (11-51-55-89)        | 122X101X34 | 6005    | 6330                  | 6655   | 6980   | 7305                             | 7630                      | 4755   | 5000     | 5245      |
| D CONF. D (11-97)              | 119X70X34  | 4490    | 4735                  | 4980   | 5225   | 5470                             | 5715                      | 3165   | 3355     | 3545      |

# WINSLOW



Hauteur complète 34" | Hauteur de siège 18" | Hauteur devant bras 22½" | Profondeur d'assise 24"  
 Total Height 34" | Seat Height 18" | Arm Height 22½" | Seat Depth 24"

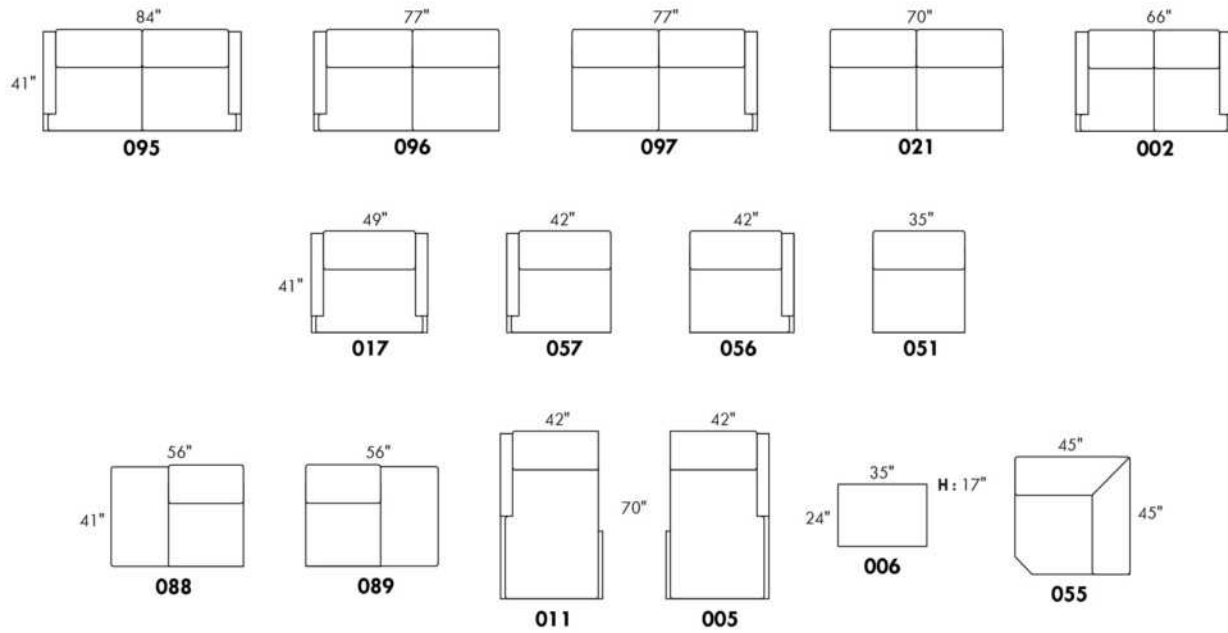

## CONFIGURATIONS

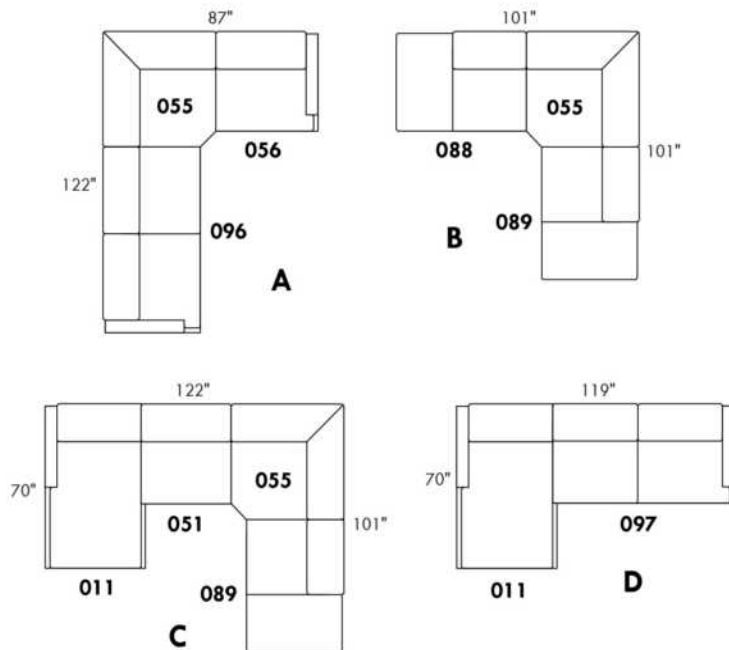

www.jaymar.ca

Toutes les dimensions indiquées sont au pouce près. Nos produits sont fabriqués à la main et des variations mineures peuvent survenir.  
 All dimensions indicated are to the nearest inch. Our product is hand-made and minor variations can occur.



### CDN Price List

## ECHO

N.B.: SOFA BED/SLEEPER items available ONLY with skus #060, #004 & #014.  
 FABRIC: There is no stitching on back and seat cushions.  
 LEG: LG51 wood (specify colour).  
 Regular sleeper and Queen sleeper feature 2 back and 2 seat cushions.  
 SINGLE Sleeper 31": with 1 BACK & 1 SEAT CUSHION.  
 SINGLE MATTRESS: Width 31".

Sofa bed MATTRESS: Regular 4" thick mattress included. OPTIONAL mattresses:  
 - 4.5" thick mattress with coils and memory foam with gel: Single \$70, Double or Queen add \$100 or  
 - 5" thick mattress with high density foam and memory foam with gel: Single \$100, Double or Queen add \$150.

| Description         | L x D x H | Leather |                       |  |  |                                  |                           | Fabric |          |           |
|---------------------|-----------|---------|-----------------------|--|--|----------------------------------|---------------------------|--------|----------|-----------|
|                     |           | 10      | 20<br>Madras<br>Softy | 30<br>Hugo<br>Fantasy<br>Illusion<br>Tucson<br>Utah<br>Vintage<br>Wild Laredo<br>Yukon | 40<br>Elegance<br>Princess<br>Santiago<br>Sensation<br>Sunset<br>Trina<br>Victoria | 50<br>Bull<br>Cassiope<br>Dublin | 60<br>Caress<br>Ultrasued | A      | B<br>COM | C<br>alta |
| 001 CHAIR           | 34X35X35  | 1100    | 1170                  | 1240   | 1310   | 1380                             | 1450                      | 830    | 890      | 950       |
| 004 DOUBLE SOFA BED | 68X35X35  | 2025    | 2145                  | 2265   | 2385   | 2505                             | 2625                      | 1525   | 1605     | 1685      |
| 014 SINGLE SOFA BED | 48X35X35  | 1520    | 1630                  | 1740   | 1850   | 1960                             | 2070                      | 1150   | 1225     | 1300      |
| 060 QUEEN SOFA BED  | 76X35X35  | 2165    | 2285                  | 2405   | 2525   | 2645                             | 2765                      | 1635   | 1720     | 1805      |

# ECHO



Hauteur complète 35" | Hauteur de siège 18" | Hauteur devant bras 25½" | Profondeur d'assise 21"  
Total Height 35" | Seat Height 18" | Arm Height 25½" | Seat Depth 21"

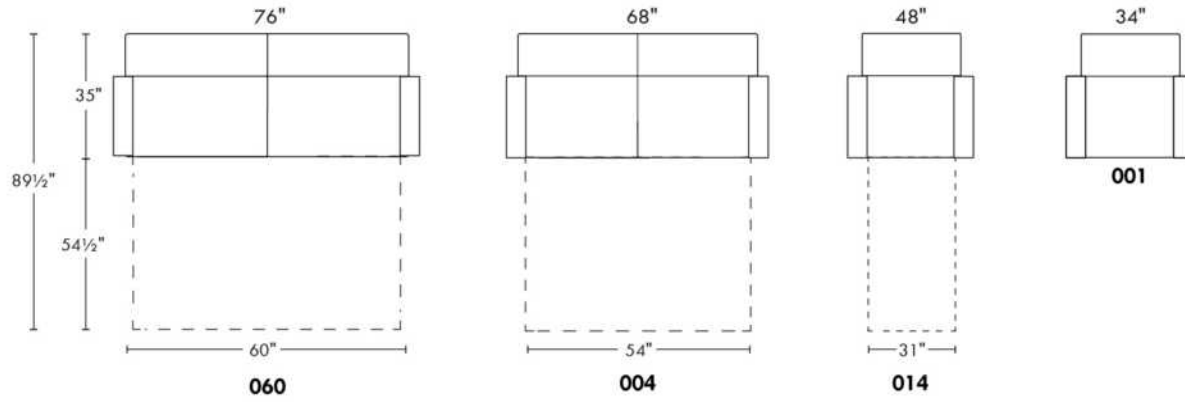

[www.jaymar.ca](http://www.jaymar.ca)

Toutes les dimensions indiquées sont au pouce près. Nos produits sont fabriqués à la main et des variations mineures peuvent survenir.  
All dimensions indicated are to the nearest inch. Our product is hand-made and minor variations can occur.

### CDN Price List

## ESTHER

N.B.: SOFA BED/SLEEPER items available ONLY with skus #060, #004 & #014.  
COMBO: Cover #2 on back and seat.  
LEG: LG65 metal or LG51 wood (specify colour).  
SINGLE Sleeper 31": with 1 BACK & 1 SEAT CUSHION.  
SINGLE MATTRESS: width 31" AND length 71"

Sofa bed MATTRESS: Regular 4" thick mattress included. OPTIONAL mattresses:  
- 4,5" thick mattress with coils and memory foam with gel: Single \$70, Double or Queen add \$100 or  
- 5" thick mattress with high density foam and memory foam with gel: Single \$100, Double or Queen add \$150.

| Description         | L x D x H    | Leather |                       |  |  |                                  |                           | Fabric |          |           |
|---------------------|--------------|---------|-----------------------|--|--|----------------------------------|---------------------------|--------|----------|-----------|
|                     |              | 10      | 20<br>Madras<br>Softy | 30<br>Hugo<br>Fantasy<br>Illusion<br>Tucson<br>Utah<br>Vintage<br>Wild Laredo<br>Yukon | 40<br>Elegance<br>Princess<br>Santiago<br>Sensation<br>Sunset<br>Trina<br>Victoria | 50<br>Bull<br>Cassiope<br>Dublin | 60<br>Caress<br>Ultrasued | A      | B<br>COM | C<br>alta |
| 001 CHAIR           | 32X36X35     | 1360    | 1450                  | 1540   | 1630   | 1720                             | 1810                      | 955    | 1005     | 1055      |
| 002 LOVESEAT        | 55X36X35     | 1875    | 1995                  | 2115   | 2235   | 2355                             | 2475                      | 1360   | 1435     | 1510      |
| 003 SOFA            | 78X36X35     | 2290    | 2425                  | 2560   | 2695   | 2830                             | 2965                      | 1660   | 1765     | 1870      |
| 004 DOUBLE SOFA BED | 70X36X35     | 2595    | 2705                  | 2815   | 2925   | 3035                             | 3145                      | 1950   | 2035     | 2120      |
| 006 OTTOMAN         | 25.5X25.5X18 | 685     | 710                   | 735  | 760  | 785                              | 810                       | 500    | 515      | 530       |
| 014 SINGLE SOFA BED | 50X36X35     | 2065    | 2170                  | 2275   | 2380   | 2485                             | 2590                      | 1610   | 1670     | 1730      |
| 060 QUEEN SOFA BED  | 78X36X35     | 2725    | 2860                  | 2995   | 3130   | 3265                             | 3400                      | 2120   | 2210     | 2300      |
| 095 APARTMENT SOFA  | 70X36X35     | 2165    | 2300                  | 2435   | 2570   | 2705                             | 2840                      | 1525   | 1615     | 1705      |

# ESTHER



Hauteur complète 35" | Hauteur de siège 19" | Hauteur devant bras 26" | Profondeur d'assise 21"  
 Total Height 35" | Seat Height 19" | Arm Height 26" | Seat Depth 21"

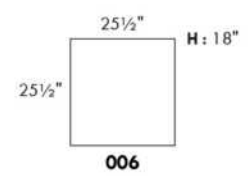
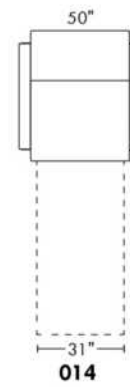
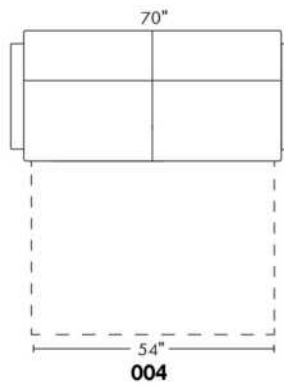
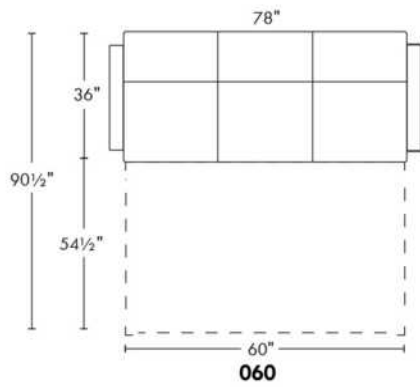
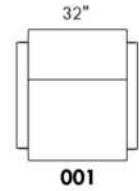
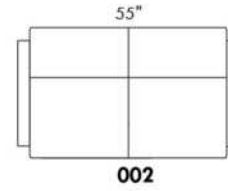
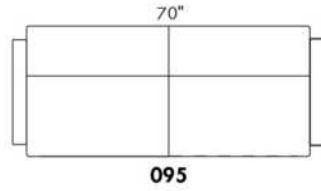
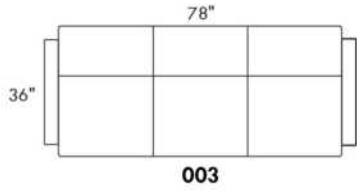

www.jaymar.ca

Toutes les dimensions indiquées sont au pouce près. Nos produits sont fabriqués à la main et des variations mineures peuvent survenir.  
 All dimensions indicated are to the nearest inch. Our product is hand-made and minor variations can occur.

### CDN Price List

## FIT

N.B.: SOFA BED/SLEEPER items available ONLY with skus #060, #004 & #014.

FABRIC: There is no stitching on back and seat cushions.

LEG: LG51 wood (specify colour).

Regular sleeper and Queen sleeper feature 2 back and 2 seat cushions.

SINGLE sleeper 31": with 1 BACK & 1 SEAT CUSHION.

SINGLE MATTRESS: Width 31".

Sofa bed MATTRESS: Regular 4" thick mattress included. OPTIONAL mattresses:

- 4.5" thick mattress with coils and memory foam with gel: Single \$70, Double or Queen add \$100 or

- 5" thick mattress with high density foam and memory foam with gel: Single \$100, Double or Queen add \$150.

| Description         | L x D x H | Leather |                       |  |  |                                  |                           | Fabric |          |           |
|---------------------|-----------|---------|-----------------------|--|--|----------------------------------|---------------------------|--------|----------|-----------|
|                     |           | 10      | 20<br>Madras<br>Softy | 30<br>Hugo<br>Fantasy<br>Illusion<br>Tucson<br>Utah<br>Vintage<br>Wild Laredo<br>Yukon | 40<br>Elegance<br>Princess<br>Santiago<br>Sensation<br>Sunset<br>Trina<br>Victoria | 50<br>Bull<br>Cassiope<br>Dublin | 60<br>Caress<br>Ultrasued | A      | B<br>COM | C<br>alta |
| 001 CHAIR           | 34X35X35  | 1100    | 1170                  | 1240   | 1310   | 1380                             | 1450                      | 830    | 890      | 950       |
| 004 DOUBLE SOFA BED | 66X35X35  | 2025    | 2145                  | 2265   | 2385   | 2505                             | 2625                      | 1525   | 1605     | 1685      |
| 014 SINGLE SOFA BED | 46X35X35  | 1520    | 1630                  | 1740   | 1850   | 1960                             | 2070                      | 1150   | 1225     | 1300      |
| 060 QUEEN SOFA BED  | 74X35X35  | 2165    | 2285                  | 2405   | 2525   | 2645                             | 2765                      | 1635   | 1720     | 1805      |

Hauteur complète 35" | Hauteur de siège 18" | Hauteur devant bras 25½" | Profondeur d'assise 21"  
 Total Height 35" | Seat Height 18" | Arm Height 25½" | Seat Depth 21"

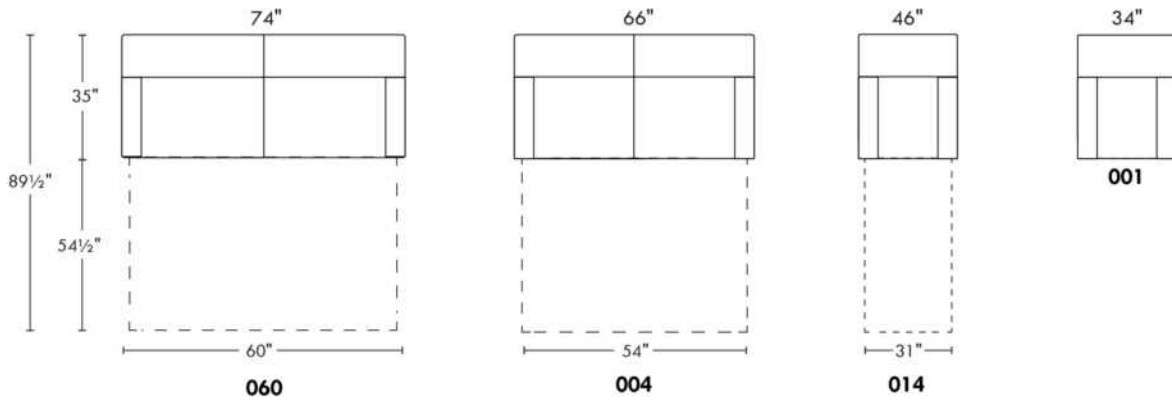

### CDN Price List

## NEW YORK

N.B.: SOFA BED/SLEEPER items available ONLY with skus #060 & #004.  
LEGS: Specify colour of legs LG4.

PLAIN FABRIC RECOMMENDED.  
COMBO: Cover #2 on back and seat.

Sofa bed MATTRESS: Regular 4" thick mattress included. OPTIONAL mattresses:  
- 4,5" thick mattress with coils and memory foam with gel: Double or Queen add \$100 or  
- 5" thick mattress with high density foam and memory foam with gel: Double or Queen add \$150.

| Description              | L x D x H    | Leather |                       |  |  |                                  |                           | Fabric |          |           |
|--------------------------|--------------|---------|-----------------------|--|--|----------------------------------|---------------------------|--------|----------|-----------|
|                          |              | 10      | 20<br>Madras<br>Softy | 30<br>Hugo<br>Fantasy<br>Illusion<br>Tucson<br>Utah<br>Vintage<br>Wild Laredo<br>Yukon | 40<br>Elegance<br>Princess<br>Santiago<br>Sensation<br>Sunset<br>Trina<br>Victoria | 50<br>Bull<br>Cassiope<br>Dublin | 60<br>Caress<br>Ultrasued | A      | B<br>COM | C<br>alta |
| 001 CHAIR                | 38x36x33     | 1360    | 1450                  | 1540   | 1630   | 1720                             | 1810                      | 1005   | 1050     | 1095      |
| 002 LOVESEAT             | 61X36X33     | 1875    | 1995                  | 2115   | 2235   | 2355                             | 2475                      | 1425   | 1505     | 1585      |
| 004 DOUBLE SOFA BED      | 76x36x33     | 2595    | 2705                  | 2815   | 2925   | 3035                             | 3145                      | 1960   | 2045     | 2130      |
| 006 OTTOMAN              | 25.5x25.5x18 | 685     | 710                   | 735  | 760  | 785                              | 810                       | 535    | 545      | 555       |
| 060 QUEEN SOFA BED       | 84x36x33     | 2725    | 2860                  | 2995   | 3130   | 3265                             | 3400                      | 2175   | 2255     | 2335      |
| 090 SOFA 2 SEATS 2 BACKS | 84x36x33     | 2290    | 2425                  | 2560   | 2695   | 2830                             | 2965                      | 1740   | 1820     | 1900      |
| 095 APARTMENT SOFA       | 76x36x33     | 2165    | 2300                  | 2435   | 2570   | 2705                             | 2840                      | 1580   | 1660     | 1740      |

# NEW YORK



Hauteur complète 33" | Hauteur de siège 17" | Hauteur devant bras 24" | Profondeur d'assise 21"  
 Total Height 33" | Seat Height 17" | Arm Height 24" | Seat Depth 21"

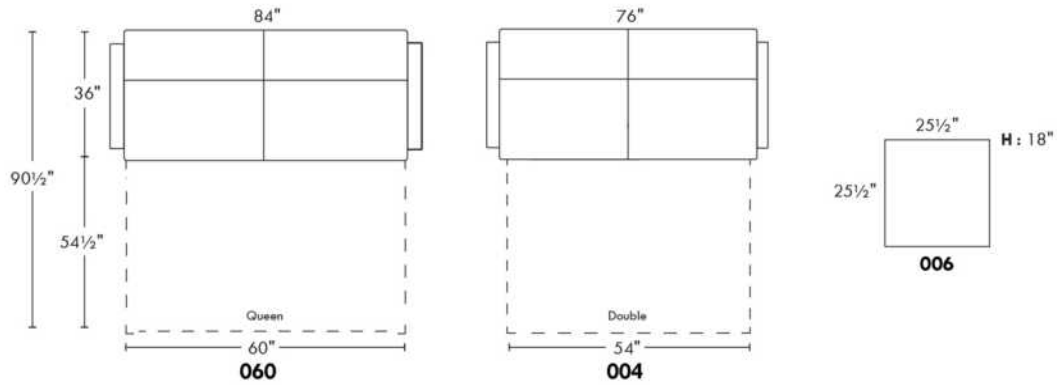
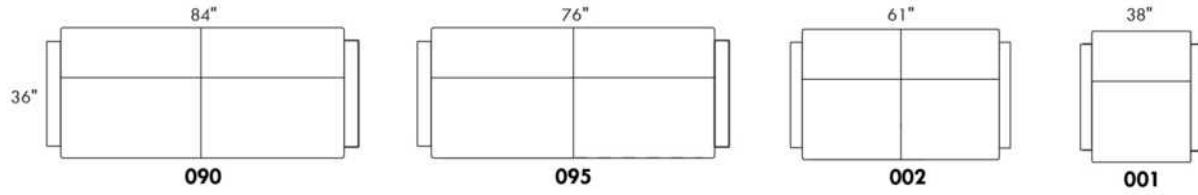

[www.jaymar.ca](http://www.jaymar.ca)

Toutes les dimensions indiquées sont au pouce près. Nos produits sont fabriqués à la main et des variations mineures peuvent survenir.  
 All dimensions indicated are to the nearest inch. Our product is hand-made and minor variations can occur.



### SCARSDALE

N.B.: SOFA BED/SLEEPER items available ONLY with skus #060, #004 & #014.

COMBO: Cover #2 on back and seat.

FABRIC: There is no stitching on back and seat cushions.  
2 arm bolster included.

In leather: Leather pillows same colour.

In fabric: Fabric pillows same colour.

SINGLE Sleeper 31": with 1 BACK & 1 SEAT CUSHION.

SINGLE MATTRESS: Width 31" and Length 71".

Sofa bed MATTRESS: Regular 4" thick mattress included. OPTIONAL mattresses:

- 4,5" thick mattress with coils and memory foam with gel: Single \$70, Double or Queen add \$100 or

- 5" thick mattress with high density foam and memory foam with gel: Single \$100, Double or Queen add \$150.

| Description         | L x D x H    | Leather |                       |  |  |                                  |                           | Fabric |          |           |
|---------------------|--------------|---------|-----------------------|--|--|----------------------------------|---------------------------|--------|----------|-----------|
|                     |              | 10      | 20<br>Madras<br>Softy | 30<br>Hugo<br>Fantasy<br>Illusion<br>Tucson<br>Utah<br>Vintage<br>Wild Laredo<br>Yukon | 40<br>Elegance<br>Princess<br>Santiago<br>Sensation<br>Sunset<br>Trina<br>Victoria | 50<br>Bull<br>Cassiope<br>Dublin | 60<br>Caress<br>Ultrasued | A      | B<br>COM | C<br>alta |
| 001 CHAIR           | 29X38X35     | 1305    | 1380                  | 1455   | 1530   | 1605                             | 1680                      | 955    | 1005     | 1055      |
| 002 LOVESEAT        | 62X38X35     | 1755    | 1860                  | 1965   | 2070   | 2175                             | 2280                      | 1320   | 1380     | 1440      |
| 004 DOUBLE SOFA BED | 67X38X35     | 2450    | 2595                  | 2740   | 2885   | 3030                             | 3175                      | 1905   | 2000     | 2095      |
| 006 OTTOMAN         | 25.5X25.5X18 | 630     | 685                   | 740  | 795  | 850                              | 905                       | 500    | 515      | 530       |
| 014 SINGLE SOFA BED | 47X38X35     | 2055    | 2165                  | 2275   | 2385   | 2495                             | 2605                      | 1625   | 1695     | 1765      |
| 060 QUEEN SOFA BED  | 75X38X35     | 2610    | 2725                  | 2840   | 2955   | 3070                             | 3185                      | 1990   | 2080     | 2170      |
| 095 APARTMENT SOFA  | 75X38X35     | 2165    | 2300                  | 2435   | 2570   | 2705                             | 2840                      | 1525   | 1615     | 1705      |

# SCARSDALE



Hauteur complète 35" | Hauteur de siège 19" | Hauteur devant bras 27" | Profondeur d'assise 20"  
 Total Height 35" | Seat Height 19" | Arm Height 27" | Seat Depth 20"

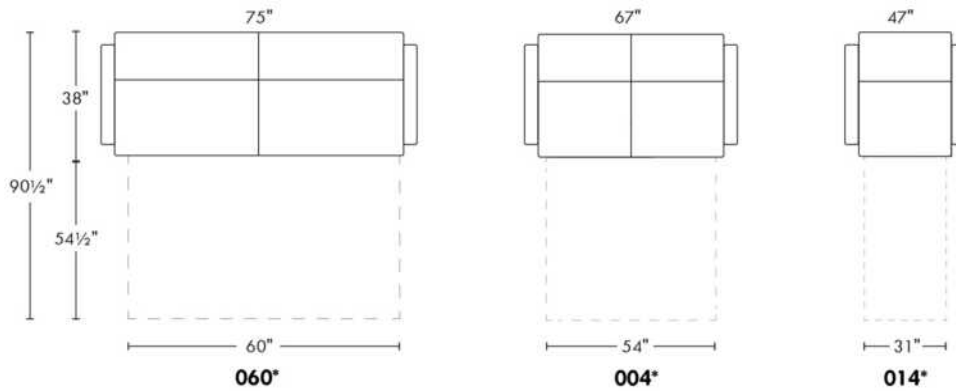
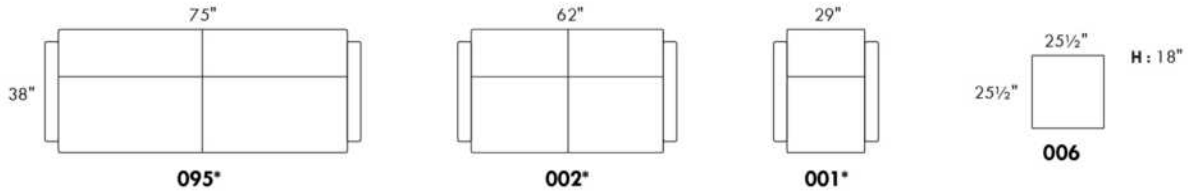

**\*2 COUSSINS DÉCORATIFS INCLUS\***

**\*2 ARM BOLSTER INCLUDED\***

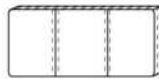

**PL31**

20" x 9" x 2"  
 rectangulaire | **rectangular**

www.jaymar.ca

Toutes les dimensions indiquées sont au pouce près. Nos produits sont fabriqués à la main et des variations mineures peuvent survenir.  
 All dimensions indicated are to the nearest inch. Our product is hand-made and minor variations can occur.

### CDN Price List

## SURF

N.B.: SOFA BED/SLEEPER items available ONLY with skus #060, #004 & #014.

PLAIN FABRIC RECOMMENDED.

COMBO: Cover #2 on back and seat.

Single Sofa Bed: Mattress 31" with 1 Back Cushion and 1 Seat Cushion.

Sofa bed MATTRESS: Regular 4" thick mattress included. OPTIONAL mattresses:

- 4,5" thick mattress with coils and memory foam with gel: Single \$70, Double or Queen add \$100 or

- 5" thick mattress with high density foam and memory foam with gel: Single \$100, Double or Queen add \$150.

| Description         | L x D x H    | Leather |                       |  |  |                                  |                           | Fabric |          |           |
|---------------------|--------------|---------|-----------------------|--|--|----------------------------------|---------------------------|--------|----------|-----------|
|                     |              | 10      | 20<br>Madras<br>Softy | 30<br>Hugo<br>Fantasy<br>Illusion<br>Tucson<br>Utah<br>Vintage<br>Wild Laredo<br>Yukon | 40<br>Elegance<br>Princess<br>Santiago<br>Sensation<br>Sunset<br>Trina<br>Victoria | 50<br>Bull<br>Cassiope<br>Dublin | 60<br>Caress<br>Ultrasued | A      | B<br>COM | C<br>alta |
| 001 CHAIR           | 34x39x36     | 1525    | 1590                  | 1655   | 1720   | 1785                             | 1850                      | 1155   | 1215     | 1275      |
| 002 LOVESEAT        | 67x39x36     | 1970    | 2055                  | 2140   | 2225   | 2310                             | 2395                      | 1525   | 1605     | 1685      |
| 004 DOUBLE SOFA BED | 72x39x36     | 2655    | 2755                  | 2855   | 2955   | 3055                             | 3155                      | 2120   | 2205     | 2290      |
| 006 OTTOMAN         | 25.5x25.5x18 | 865     | 895                   | 925  | 955  | 985                              | 1015                      | 710    | 725      | 740       |
| 014 SINGLE SOFA BED | 52x39x36     | 2280    | 2370                  | 2460   | 2550   | 2640                             | 2730                      | 1835   | 1915     | 1995      |
| 060 QUEEN SOFA BED  | 80x39x36     | 2805    | 2910                  | 3015   | 3120   | 3225                             | 3330                      | 2200   | 2305     | 2410      |
| 095 APARTMENT SOFA  | 80x39x36     | 2400    | 2495                  | 2590   | 2685   | 2780                             | 2875                      | 1740   | 1820     | 1900      |

# SURF



Hauteur complète 36" | Hauteur de siège 22" | Hauteur devant bras 28½" | Profondeur d'assise 21½"  
 Total Height 36" | Seat Height 22" | Arm Height 28½" | Seat Depth 21½"

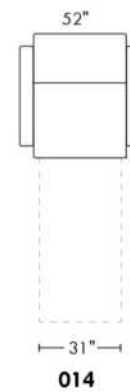
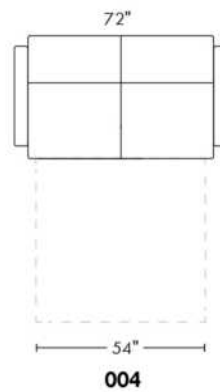
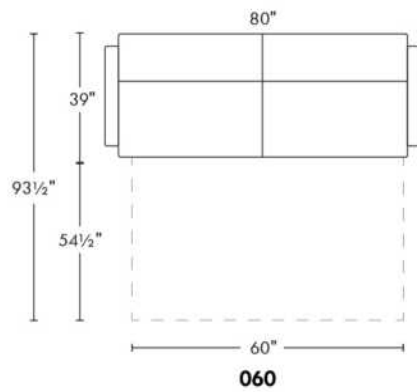
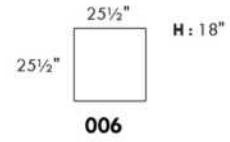
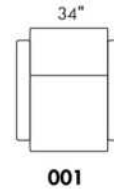
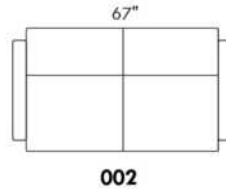
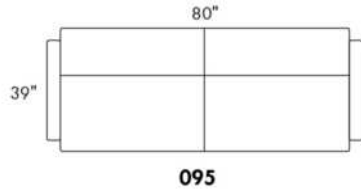

www.jaymar.ca

Toutes les dimensions indiquées sont au pouce près. Nos produits sont fabriqués à la main et des variations mineures peuvent survenir.  
 All dimensions indicated are to the nearest inch. Our product is hand-made and minor variations can occur.

### YARIS

N.B.: SOFA BED/SLEEPER items available ONLY with skus #060, #004 & #014.  
 FABRIC: There is no stitching on back and seat cushions.  
 LEG: LG51 (specify colour).  
 Regular sleeper and Queen sleeper feature 2 back and 2 seat cushions.  
 SINGLE sleeper 31": with 1 BACK & 1 SEAT CUSHION.  
 SINGLE MATTRESS: Width 31".

Sofa bed MATTRESS: Regular 4" thick mattress included. OPTIONAL mattresses:  
 - 4.5" thick mattress with coils and memory foam with gel: Single \$70, Double or Queen add \$100 or  
 - 5" thick mattress with high density foam and memory foam with gel: Single \$100, Double or Queen add \$150.

| Description         | L x D x H | Leather |                       |  |  |                                  |                           | Fabric |          |           |
|---------------------|-----------|---------|-----------------------|--|--|----------------------------------|---------------------------|--------|----------|-----------|
|                     |           | 10      | 20<br>Madras<br>Softy | 30<br>Hugo<br>Fantasy<br>Illusion<br>Tucson<br>Utah<br>Vintage<br>Wild Laredo<br>Yukon | 40<br>Elegance<br>Princess<br>Santiago<br>Sensation<br>Sunset<br>Trina<br>Victoria | 50<br>Bull<br>Cassiope<br>Dublin | 60<br>Caress<br>Ultrasued | A      | B<br>COM | C<br>alta |
| 001 CHAIR           | 34X35X35  | 1100    | 1170                  | 1240   | 1310   | 1380                             | 1450                      | 830    | 890      | 950       |
| 004 DOUBLE SOFA BED | 68X35X35  | 2025    | 2145                  | 2265   | 2385   | 2505                             | 2625                      | 1525   | 1605     | 1685      |
| 014 SINGLE SOFA BED | 48X35X35  | 1520    | 1630                  | 1740   | 1850   | 1960                             | 2070                      | 1150   | 1225     | 1300      |
| 060 QUEEN SOFA BED  | 76X35X35  | 2165    | 2285                  | 2405   | 2525   | 2645                             | 2765                      | 1635   | 1720     | 1805      |

# YARIS



Hauteur complète 35" | Hauteur de siège 18" | Hauteur devant bras 25½" | Profondeur d'assise 21"  
Total Height 35" | Seat Height 18" | Arm Height 25½" | Seat Depth 21"

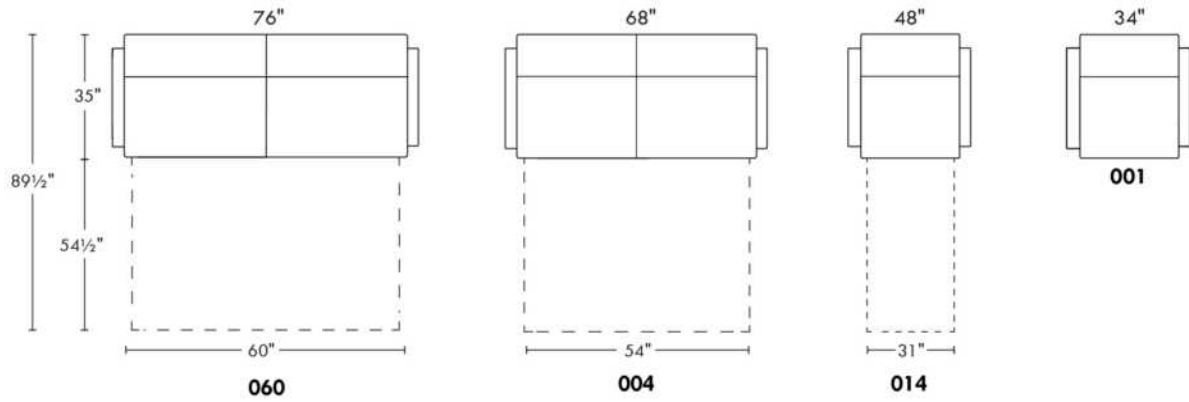

[www.jaymar.ca](http://www.jaymar.ca)

Toutes les dimensions indiquées sont au pouce près. Nos produits sont fabriqués à la main et des variations mineures peuvent survenir.  
All dimensions indicated are to the nearest inch. Our product is hand-made and minor variations can occur.



## 99900 BASE L

FOR HEADBOARD WITHOUT WINGS

\*Base WITH LEGS: Specify leg choice: LG182 wood (colour), LG60 metal or LG189 metal.

\*NB: Narrow bed base for "ADJUSTABLE BED" (items 560-561-563): WOOD leg only (specify colour).

WIDE CONTOUR base - with LEGS & NO DUST - Posture Board included.

Includes: 3 wood slats and 2 central leg heights: High position at 9.75" (8.25" leg) or low position at 6.5" (5" leg).

WIDE CONTOUR base with STORAGE - plywood posture board included.

NARROW CONTOUR base - posture board included at fixed height of 10,25".

NARROW CONTOUR base for ADJUSTABLE BED: Interior dimensions: King: 78"W x 82"D | Queen: 61"W x 82"D | Single: 40"W x 82"D

NARROW CONTOUR base with STORAGE: Attn: The contour will be 1" wider to support the storage mechanism.

SIDE DRAWER BASES: King and Queen bases have 2 DRAWERS (1 on each side). / Double and Single bases only have 1 DRAWER. Please specify on your order which side (front view facing). SIDE DRAWER: Clearance space for night table is minimum 20" from wall.

Birch DRAWER DIMENSIONS for Front & Side Drawers: King & Queen: 54.25"x 24.5" x 5". / Double & Single: 48.25" x 24.5" x 5".

DRAWER OPENED: Leave at least 18" clearance space.

NB: Only bed bases with "Drawers" (frontal or side) can be sold separately. The headboard side of the bed base will not be finished.

| Description                       | L x D x H    | Leather |                       |  |  |                                  |                           | Fabric |          |           |
|-----------------------------------|--------------|---------|-----------------------|--|--|----------------------------------|---------------------------|--------|----------|-----------|
|                                   |              | 10      | 20<br>Madras<br>Softy | 30<br>Hugo<br>Fantasy<br>Illusion<br>Tucson<br>Utah<br>Vintage<br>Wild Laredo<br>Yukon | 40<br>Elegance<br>Princess<br>Santiago<br>Sensation<br>Sunset<br>Trina<br>Victoria | 50<br>Bull<br>Cassiope<br>Dublin | 60<br>Caress<br>Ultrasued | A      | B<br>COM | C<br>alta |
| 410 KING WIDE BASE WITH LEGS      | 87 x 86 x 12 | 795     | 895                   | 995  | 1095   | 1195                             | 1295                      | 635    | 660      | 685       |
| 411 QUEEN WIDE BASE WITH LEGS     | 69 x 86 x 12 | 735     | 835                   | 935  | 1035   | 1135                             | 1235                      | 570    | 590      | 610       |
| 412 DOUBLE WIDE BASE WITH LEGS    | 64 x 82 x 12 | 685     | 755                   | 825  | 895  | 965                              | 1035                      | 525    | 540      | 555       |
| 413 SINGLE WIDE BASE WITH LEGS    | 49 x 82 x 12 | 575     | 650                   | 725  | 800  | 875                              | 950                       | 510    | 525      | 540       |
| 420 KING WIDE NO DUST BASE        | 87 x 86 x 12 | 955     | 1075                  | 1195   | 1315   | 1435                             | 1555                      | 735    | 760      | 785       |
| 421 QUEEN WIDE NO DUST BASE       | 69 x 86 x 12 | 875     | 985                   | 1095   | 1205   | 1315                             | 1425                      | 665    | 685      | 705       |
| 422 DOUBLE WIDE NO DUST BASE      | 64 x 82 x 12 | 820     | 910                   | 1000   | 1090   | 1180                             | 1270                      | 635    | 655      | 675       |
| 423 SINGLE WIDE NO DUST BASE      | 49 x 82 x 12 | 735     | 830                   | 925  | 1020   | 1115                             | 1210                      | 620    | 640      | 660       |
| 430 KING WIDE BASE WITH STORAGE   | 87 x 86 x 12 | 1295    | 1430                  | 1565   | 1700   | 1835                             | 1970                      | 1085   | 1115     | 1145      |
| 431 QUEEN WIDE BASE WITH STORAGE  | 69 x 86 x 12 | 1135    | 1225                  | 1315   | 1405   | 1495                             | 1585                      | 925    | 945      | 965       |
| 440 KING WIDE BASE FRONT DRAWER   | 87 x 86 x 12 | 1355    | 1485                  | 1615   | 1745   | 1875                             | 2005                      | 1155   | 1185     | 1215      |
| 441 QUEEN WIDE BASE FRONT DRAWER  | 69 x 86 x 12 | 1275    | 1380                  | 1485   | 1590   | 1695                             | 1800                      | 1070   | 1085     | 1100      |
| 442 DOUBLE WIDE BASE FRONT DRAWER | 64 x 82 x 12 | 1225    | 1320                  | 1415   | 1510   | 1605                             | 1700                      | 1065   | 1080     | 1095      |
| 450 KING WIDE BASE SIDE DRAWERS   | 87 x 86 x 12 | 1660    | 1780                  | 1900   | 2020   | 2140                             | 2260                      | 1470   | 1500     | 1530      |
| 451 QUEEN WIDE BASE SIDE DRAWERS  | 69 x 86 x 12 | 1650    | 1755                  | 1860   | 1965   | 2070                             | 2175                      | 1465   | 1490     | 1515      |
| 452 DOUBLE WIDE BASE SIDE DRAWER  | 64 x 82 x 12 | 1225    | 1320                  | 1415   | 1510   | 1605                             | 1700                      | 1065   | 1080     | 1095      |



## 99900 BASE L

FOR HEADBOARD WITHOUT WINGS

\*Base WITH LEGS: Specify leg choice: LG182 wood (colour), LG60 metal or LG189 metal.

\*NB: Narrow bed base for "ADJUSTABLE BED" (items 560-561-563): WOOD leg only (specify colour).

WIDE CONTOUR base - with LEGS & NO DUST - Posture Board included.

Includes: 3 wood slats and 2 central leg heights: High position at 9.75" (8.25" leg) or low position at 6.5" (5" leg).

WIDE CONTOUR base with STORAGE - plywood posture board included.

NARROW CONTOUR base - posture board included at fixed height of 10,25".

NARROW CONTOUR base for AJDUSTABLE BED: Interior dimensions: King: 78"W x 82"D | Queen: 61"W x 82"D | Single: 40"W x 82"D

NARROW CONTOUR base with STORAGE: Attn: The contour will be 1" wider to support the storage mechanism.

SIDE DRAWER BASES: King and Queen bases have 2 DRAWERS (1 on each side). / Double and Single bases only have 1 DRAWER. Please specify on your order which side (front view facing). SIDE DRAWER: Clearance space for night table is minimum 20" from wall.

Birch DRAWER DIMENSIONS for Front & Side Drawers: King & Queen: 54.25"x 24.5" x 5". / Double & Single: 48.25" x 24.5" x 5".

DRAWER OPENED: Leave at least 18" clearance space.

NB: Only bed bases with "Drawers" (frontal or side) can be sold separately. The headboard side of the bed base will not be finished.

| Description                            | L x D x H    | Leather |                       |  |  |                                  |                           | Fabric |          |           |
|--|--------------|---------|-----------------------|--|--|----------------------------------|---------------------------|--------|----------|-----------|
|  |              | 10      | 20<br>Madras<br>Softy | 30<br>Hugo<br>Fantasy<br>Illusion<br>Tucson<br>Utah<br>Vintage<br>Wild Laredo<br>Yukon | 40<br>Elegance<br>Princess<br>Santiago<br>Sensation<br>Sunset<br>Trina<br>Victoria | 50<br>Bull<br>Cassiope<br>Dublin | 60<br>Caress<br>Ultrasued | A      | B<br>COM | C<br>alta |
| 453 SINGLE WIDE BASE SIDE DRAWER       | 49 x 82 x 12 | 1225    | 1310                  | 1395   | 1480   | 1565                             | 1650                      | 1065   | 1080     | 1095      |
| 510 KING NARROW BASE WITH LEGS         | 82 x 84 x 12 | 795     | 905                   | 1015   | 1125   | 1235                             | 1345                      | 635    | 665      | 695       |
| 511 QUEEN NARROW BASE WITH LEGS        | 64 x 84 x 12 | 735     | 835                   | 935  | 1035   | 1135                             | 1235                      | 570    | 590      | 610       |
| 512 DOUBLE NARROW BASE WITH LEGS       | 59 x 80 x 12 | 700     | 780                   | 860  | 940  | 1020                             | 1100                      | 540    | 560      | 580       |
| 513 SINGLE NARROW BASE WITH LEGS       | 44 x 80 x 12 | 575     | 655                   | 735  | 815  | 895                              | 975                       | 510    | 525      | 540       |
| 520 KING NARROW NO DUST BASE           | 82 x 84 x 12 | 960     | 1075                  | 1190   | 1305   | 1420                             | 1535                      | 740    | 760      | 780       |
| 521 QUEEN NARROW NO DUST BASE          | 64 x 84 x 12 | 880     | 985                   | 1090   | 1195   | 1300                             | 1405                      | 680    | 695      | 710       |
| 522 DOUBLE NARROW NO DUST BASE         | 59 x 80 x 12 | 830     | 920                   | 1010   | 1100   | 1190                             | 1280                      | 655    | 675      | 695       |
| 523 SIMPLE NARROW NO DUST BASE         | 44 x 80 x 12 | 735     | 830                   | 925  | 1020   | 1115                             | 1210                      | 620    | 645      | 670       |
| 530 KING NARROW BASE WITH STORAGE      | 83 x 84 x 12 | 1295    | 1430                  | 1565   | 1700   | 1835                             | 1970                      | 1085   | 1115     | 1145      |
| 531 QUEEN NARROW BED BASE WITH STORAGE | 66 x 84 x 12 | 1135    | 1225                  | 1315   | 1405   | 1495                             | 1585                      | 925    | 945      | 965       |
| 540 KING NARROW BASE FRONT DRAWER      | 82 x 84 x 12 | 1355    | 1485                  | 1615   | 1745   | 1875                             | 2005                      | 1155   | 1185     | 1215      |
| 541 QUEEN NARROW BASE FRONT DRAWER     | 64 x 84 x 12 | 1275    | 1380                  | 1485   | 1590   | 1695                             | 1800                      | 1070   | 1085     | 1100      |
| 542 DOUBLE NARROW BASE FRONT DRAWER    | 59 x 80 x 12 | 1225    | 1320                  | 1415   | 1510   | 1605                             | 1700                      | 1065   | 1080     | 1095      |
| 550 KING NARROW BASE SIDE DRAWERS      | 82 x 84 x 12 | 1660    | 1780                  | 1900   | 2020   | 2140                             | 2260                      | 1470   | 1500     | 1530      |
| 551 QUEEN NARROW BASE SIDE DRAWERS     | 64 x 84 x 12 | 1650    | 1755                  | 1860   | 1965   | 2070                             | 2175                      | 1465   | 1490     | 1515      |
| 552 DOUBLE NARROW BASE SIDE DRAWER     | 59 x 80 x 12 | 1225    | 1320                  | 1415   | 1510   | 1605                             | 1700                      | 1065   | 1080     | 1095      |





## 99900 BASE L

FOR HEADBOARD WITHOUT WINGS

\*Base WITH LEGS: Specify leg choice: LG182 wood (colour), LG60 metal or LG189 metal.

\*NB: Narrow bed base for "ADJUSTABLE BED" (items 560-561-563): WOOD leg only (specify colour).

WIDE CONTOUR base - with LEGS & NO DUST - Posture Board included.

Includes: 3 wood slats and 2 central leg heights: High position at 9.75" (8.25" leg) or low position at 6.5" (5" leg).

WIDE CONTOUR base with STORAGE - plywood posture board included.

NARROW CONTOUR base - posture board included at fixed height of 10,25".

NARROW CONTOUR base for AJDUSTABLE BED: Interior dimensions: King: 78"W x 82"D | Queen: 61"W x 82"D | Single: 40"W x 82"D

NARROW CONTOUR base with STORAGE: Attn: The contour will be 1" wider to support the storage mechanism.

SIDE DRAWER BASES: King and Queen bases have 2 DRAWERS (1 on each side). / Double and Single bases only have 1 DRAWER. Please specify on your order which side (front view facing). SIDE DRAWER: Clearance space for night table is minimum 20" from wall.

Birch DRAWER DIMENSIONS for Front & Side Drawers: King & Queen: 54.25"x 24.5" x 5". / Double & Single: 48.25" x 24.5" x 5".

DRAWER OPENED: Leave at least 18" clearance space.

NB: Only bed bases with "Drawers" (frontal or side) can be sold separately. The headboard side of the bed base will not be finished.

| Description                               | L x D x H    | Leather |                       |  |  |                                  |                           | Fabric |          |           |
|---|--------------|---------|-----------------------|--|--|----------------------------------|---------------------------|--------|----------|-----------|
|   |              | 10      | 20<br>Madras<br>Softy | 30<br>Hugo<br>Fantasy<br>Illusion<br>Tucson<br>Utah<br>Vintage<br>Wild Laredo<br>Yukon | 40<br>Elegance<br>Princess<br>Santiago<br>Sensation<br>Sunset<br>Trina<br>Victoria | 50<br>Bull<br>Cassiope<br>Dublin | 60<br>Caress<br>Ultrasued | A      | B<br>COM | C<br>alta |
| 553 SINGLE NARROW BASE SIDE DRAWER        | 44 x 80 x 12 | 1225    | 1310                  | 1395   | 1480   | 1565                             | 1650                      | 1065   | 1080     | 1095      |
| 560 KING NARROW BASE FOR ADJUSTABLE BED   | 82x84x12     | 795     | 905                   | 1015   | 1125   | 1235                             | 1345                      | 635    | 665      | 695       |
| 561 QUEEN NARROW BASE FOR ADJUSTABLE BED  | 65x84x12     | 735     | 835                   | 935  | 1035   | 1135                             | 1235                      | 570    | 590      | 610       |
| 563 SINGLE NARROW BASE FOR ADJUSTABLE BED | 44x84x12     | 575     | 655                   | 735  | 815  | 895                              | 975                       | 510    | 525      | 540       |

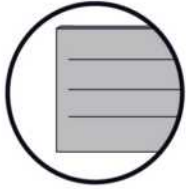

# 99900

## BASE pour tête de lit SANS oreilles Bed base for headboard WITHOUT wings

### 4" Base contour LARGE | WIDE contour Base

#### DIMENSIONS

Base de lits seulement  
Bed base only

L x P/D x H

|   |                 |
|---|-----------------|
| K | 87" x 86" x 12" |
| Q | 69" x 86" x 12" |
| D | 64" x 82" x 12" |
| S | 49" x 82" x 12" |



\*Avec pattes | \*With Legs  
K 410 - Q 411 - D 412 - S 413

2 positions de matelas à 9,75" ou 6,5" du plancher  
2 mattress position from 9,75" or 6,5" from the floor



Anti-poussière | No Dust  
K 420 - Q 421 - D 422 - S 423

2 positions de matelas à 9,75" ou 6,5" du plancher  
2 mattress position from 9,75" or 6,5" from the floor

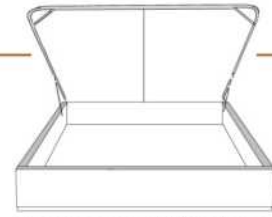

Avec rangement | With Storage  
K 430 - Q 431

1 position de matelas à 10,25" du plancher  
1 mattress position at 10,25" from floor



Rangement à tiroir frontal  
With Front Drawer  
K 440 - Q 441 - D 442

1 position de matelas à 10,25" du plancher  
1 mattress position at 10,25" from floor



Rangement à tiroir latéraux  
With Side Drawers  
K 450 - Q 451 (2 tiroirs | drawers)  
D 452 - S 453 (1 tiroir | drawer)

1 position de matelas à 10,25" du plancher  
1 mattress position at 10,25" from floor

### 2" Base contour MINCE | NARROW contour Base

#### DIMENSIONS

Base de lits seulement  
Bed base only

L x P/D x H

|   |                 |
|---|-----------------|
| K | 82" x 84" x 12" |
| Q | 64" x 84" x 12" |
| D | 59" x 80" x 12" |
| S | 44" x 80" x 12" |



\*Avec pattes | \*With Legs  
K 510 - Q 511 - D 512 - S 513

1 position de matelas à 10,25" du plancher  
1 mattress position at 10,25" from floor



Anti-poussière | No Dust  
K 520 - Q 521 - D 522 - S 523

1 position de matelas à 10,25" du plancher  
1 mattress position at 10,25" from floor

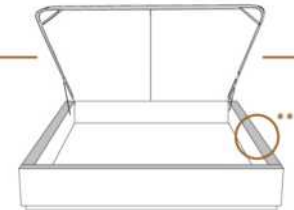

Avec rangement | With Storage  
\*\*1" plus large | \*\*1" wider  
K 530 - Q 531

1 position de matelas à 10,25" du plancher  
1 mattress position at 10,25" from floor



Lit réglable | Adjustable bed  
Pattes de bois seulement | Wood leg only  
K 560 - Q 561 - S 563

|      | King     | Queen    | Simple Single |
|------|----------|----------|---------------|
| EXT: | 87x89x56 | 69x89x56 | 49x89x56      |
| INT: | 78x82x12 | 61x82x12 | 40x82x12      |

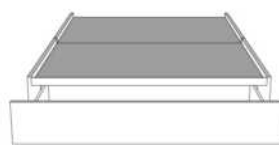

Rangement à tiroir frontal  
With Front Drawer  
K 540 - Q 541 - D 542

1 position de matelas à 10,25" du plancher  
1 mattress position at 10,25" from floor



Rangement à tiroir latéraux  
With Side Drawers  
K 550 - Q 551 (2 tiroirs | drawers)  
D 552 - S 553 (1 tiroir | drawer)

1 position de matelas à 10,25" du plancher  
1 mattress position at 10,25" from floor

Les illustrations sont génériques et n'indiquent pas tous les détails de coutures. | The sketches are generic and do not reflect all sewing details.

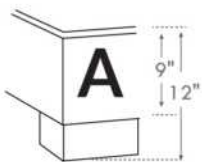

LG182 Bois | Wood

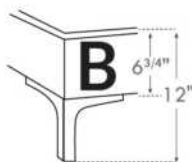

LG60 Metal

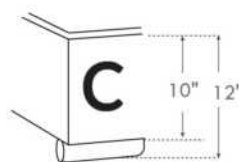

LG189 Metal

\*Choix de pattes (Seulement pour base avec pattes)  
\*Leg choices (Only for Bed base with legs)

### N.B.

La hauteur du pied et longeron varie selon la patte choisie.  
Foot & siderail height varies according to leg choice.



## 99905 BASE C

### FOR HEADBOARD WITH WINGS

\*Base with legs: Specify leg choice: LG182 wood (colour), LG60 metal or LG189 metal.

\*NB: Narrow bed base for "ADJUSTABLE BED" (items 560-561-563): WOOD leg only (specify colour).

WIDE CONTOUR BASE - WITH LEGS & NO DUST - Posture Board included.

Includes: 3 wood slats and 2 central leg heights: High position at 9.75" (8.25" leg) or low position at 6.5" (5" leg).

WIDE CONTOUR BASE WITH STORAGE - plywood posture board included.

NARROW CONTOUR BASE - posture board included at fixed height of 10,25".

NARROW CONTOUR base for AJDUSTABLE BED: Interior dimensions including headboard depth: King: 78"W x 82"D | Queen: 61"W x 82"D | Single: 40"W x 82"D.

NARROW CONTOUR base with STORAGE: Attn: The contour will be 1" wider to support the storage mechanism.

SIDE DRAWER BASES: King and Queen bases have 2 DRAWERS (1 on each side). / Double and Single bases only have 1 DRAWER. Please specify on your order which side (front view facing).

SIDE DRAWER: Clearance space for night table is minimum 20" from wall.

Birch DRAWER DIMENSIONS for Front & Side Drawers: King & Queen: 54.25"x 24.5" x 5". / Double & Single: 48.25" x 24.5" x 5".

Drawer opened: Leave at least 18" clearance space.

NB: Only bed bases with "Drawers" (frontal or side) can be sold separately. The headboard side of the bed base will not be finished.

| Description                       | L x D x H    | Leather |                       |  |  |                                  |                           | Fabric |          |           |
|-----------------------------------|--------------|---------|-----------------------|--|--|----------------------------------|---------------------------|--------|----------|-----------|
|                                   |              | 10      | 20<br>Madras<br>Softy | 30<br>Hugo<br>Fantasy<br>Illusion<br>Tucson<br>Utah<br>Vintage<br>Wild Laredo<br>Yukon | 40<br>Elegance<br>Princess<br>Santiago<br>Sensation<br>Sunset<br>Trina<br>Victoria | 50<br>Bull<br>Cassiope<br>Dublin | 60<br>Caress<br>Ultrasued | A      | B<br>COM | C<br>alta |
| 410 KING WIDE BASE WITH LEGS      | 87 x 79 x 12 | 795     | 895                   | 995  | 1095   | 1195                             | 1295                      | 635    | 660      | 685       |
| 411 QUEEN WIDE BASE WITH LEGS     | 69 x 79 x 12 | 735     | 835                   | 935  | 1035   | 1135                             | 1235                      | 570    | 590      | 610       |
| 412 DOUBLE WIDE BASE WITH LEGS    | 64 x 75 x 12 | 685     | 755                   | 825  | 895  | 965                              | 1035                      | 525    | 540      | 555       |
| 413 SINGLE WIDE BASE WITH LEGS    | 49 x 75 x 12 | 575     | 650                   | 725  | 800  | 875                              | 950                       | 510    | 525      | 540       |
| 420 KING WIDE NO DUST BASE        | 87 x 79 x 12 | 955     | 1075                  | 1195   | 1315   | 1435                             | 1555                      | 735    | 760      | 785       |
| 421 QUEEN WIDE NO DUST BASE       | 69 x 79 x 12 | 875     | 985                   | 1095   | 1205   | 1315                             | 1425                      | 665    | 685      | 705       |
| 422 DOUBLE WIDE NO DUST BASE      | 64 x 75 x 12 | 820     | 910                   | 1000   | 1090   | 1180                             | 1270                      | 635    | 655      | 675       |
| 423 SINGLE WIDE NO DUST BASE      | 49 x 75 x 12 | 735     | 830                   | 925  | 1020   | 1115                             | 1210                      | 620    | 640      | 660       |
| 430 KING WIDE BASE WITH STORAGE   | 87 x 79 x 12 | 1295    | 1430                  | 1565   | 1700   | 1835                             | 1970                      | 1085   | 1115     | 1145      |
| 431 QUEEN WIDE BASE WITH STORAGE  | 69 x 79 x 12 | 1135    | 1225                  | 1315   | 1405   | 1495                             | 1585                      | 925    | 945      | 965       |
| 440 KING WIDE BASE FRONT DRAWER   | 87 x 79 x 12 | 1355    | 1485                  | 1615   | 1745   | 1875                             | 2005                      | 1155   | 1185     | 1215      |
| 441 QUEEN WIDE BASE FRONT DRAWER  | 69 x 79 x 12 | 1275    | 1380                  | 1485   | 1590   | 1695                             | 1800                      | 1070   | 1085     | 1100      |
| 442 DOUBLE WIDE BASE FRONT DRAWER | 64 x 75 x 12 | 1225    | 1320                  | 1415   | 1510   | 1605                             | 1700                      | 1065   | 1080     | 1095      |
| 450 KING WIDE BASE SIDE DRAWERS   | 87 x 79 x 12 | 1660    | 1780                  | 1900   | 2020   | 2140                             | 2260                      | 1470   | 1500     | 1530      |
| 451 QUEEN WIDE BASE SIDE DRAWERS  | 69 x 79 x 12 | 1650    | 1755                  | 1860   | 1965   | 2070                             | 2175                      | 1465   | 1490     | 1515      |
| 452 DOUBLE WIDE BASE SIDE DRAWER  | 64 x 75 x 12 | 1225    | 1320                  | 1415   | 1510   | 1605                             | 1700                      | 1065   | 1080     | 1095      |



## 99905 BASE C

FOR HEADBOARD WITH WINGS

\*Base with legs: Specify leg choice: LG182 wood (colour), LG60 metal or LG189 metal.

\*NB: Narrow bed base for "ADJUSTABLE BED" (items 560-561-563): WOOD leg only (specify colour).

WIDE CONTOUR BASE - WITH LEGS & NO DUST - Posture Board included.

Includes: 3 wood slats and 2 central leg heights: High position at 9.75" (8.25" leg) or low position at 6.5" (5" leg).

WIDE CONTOUR BASE WITH STORAGE - plywood posture board included.

NARROW CONTOUR BASE - posture board included at fixed height of 10,25".

NARROW CONTOUR base for AJDUSTABLE BED: Interior dimensions including headboard depth: King: 78"W x 82"D | Queen: 61"W x 82"D | Single: 40"W x 82"D.

NARROW CONTOUR base with STORAGE: Attn: The contour will be 1" wider to support the storage mechanism.

SIDE DRAWER BASES: King and Queen bases have 2 DRAWERS (1 on each side). / Double and Single bases only have 1 DRAWER. Please specify on your order which side (front view facing).

SIDE DRAWER: Clearance space for night table is minimum 20" from wall.

Birch DRAWER DIMENSIONS for Front & Side Drawers: King & Queen: 54.25"x 24.5" x 5". / Double & Single: 48.25" x 24.5" x 5".

Drawer opened: Leave at least 18" clearance space.

NB: Only bed bases with "Drawers" (frontal or side) can be sold separately. The headboard side of the bed base will not be finished.

| Description                            | L x D x H    | Leather |                       |  |  |                                  |                           | Fabric |          |           |
|--|--------------|---------|-----------------------|--|--|----------------------------------|---------------------------|--------|----------|-----------|
|  |              | 10      | 20<br>Madras<br>Softy | 30<br>Hugo<br>Fantasy<br>Illusion<br>Tucson<br>Utah<br>Vintage<br>Wild Laredo<br>Yukon | 40<br>Elegance<br>Princess<br>Santiago<br>Sensation<br>Sunset<br>Trina<br>Victoria | 50<br>Bull<br>Cassiope<br>Dublin | 60<br>Caress<br>Ultrasued | A      | B<br>COM | C<br>alta |
| 453 SINGLE WIDE BASE SIDE DRAWER       | 49 x 75 x 12 | 1225    | 1310                  | 1395   | 1480   | 1565                             | 1650                      | 1065   | 1080     | 1095      |
| 510 KING NARROW BASE WITH LEGS         | 82 x 77 x 12 | 795     | 905                   | 1015   | 1125   | 1235                             | 1345                      | 635    | 665      | 695       |
| 511 QUEEN NARROW BASE WITH LEGS        | 64 x 77 x 12 | 735     | 835                   | 935  | 1035   | 1135                             | 1235                      | 570    | 590      | 610       |
| 512 DOUBLE NARROW BASE WITH LEGS       | 59 x 73 x 12 | 700     | 780                   | 860  | 940  | 1020                             | 1100                      | 540    | 560      | 580       |
| 513 SINGLE NARROW BASE WITH LEGS       | 44 x 73 x 12 | 575     | 655                   | 735  | 815  | 895                              | 975                       | 510    | 525      | 540       |
| 520 KING NARROW NO DUST BASE           | 82 x 77 x 12 | 960     | 1075                  | 1190   | 1305   | 1420                             | 1535                      | 740    | 760      | 780       |
| 521 QUEEN NARROW NO DUST BASE          | 64 x 77 x 12 | 880     | 985                   | 1090   | 1195   | 1300                             | 1405                      | 680    | 695      | 710       |
| 522 DOUBLE NARROW NO DUST BASE         | 59 x 73 x 12 | 830     | 920                   | 1010   | 1100   | 1190                             | 1280                      | 655    | 675      | 695       |
| 523 SIMPLE NARROW NO DUST BASE         | 44 x 73 x 12 | 735     | 830                   | 925  | 1020   | 1115                             | 1210                      | 620    | 645      | 670       |
| 530 KING NARROW BASE WITH STORAGE      | 83 x 77 x 12 | 1295    | 1430                  | 1565   | 1700   | 1835                             | 1970                      | 1085   | 1115     | 1145      |
| 531 QUEEN NARROW BED BASE WITH STORAGE | 66 x 77 x 12 | 1135    | 1225                  | 1315   | 1405   | 1495                             | 1585                      | 925    | 945      | 965       |
| 540 KING NARROW BASE FRONT DRAWER      | 82 x 77 x 12 | 1355    | 1485                  | 1615   | 1745   | 1875                             | 2005                      | 1155   | 1185     | 1215      |
| 541 QUEEN NARROW BASE FRONT DRAWER     | 64 x 77 x 12 | 1275    | 1380                  | 1485   | 1590   | 1695                             | 1800                      | 1070   | 1085     | 1100      |
| 542 DOUBLE NARROW BASE FRONT DRAWER    | 59 x 73 x 12 | 1225    | 1320                  | 1415   | 1510   | 1605                             | 1700                      | 1065   | 1080     | 1095      |
| 550 KING NARROW BASE SIDE DRAWERS      | 82 x 77 x 12 | 1660    | 1780                  | 1900   | 2020   | 2140                             | 2260                      | 1470   | 1500     | 1530      |
| 551 QUEEN NARROW BASE SIDE DRAWERS     | 64 x 77 x 12 | 1650    | 1755                  | 1860   | 1965   | 2070                             | 2175                      | 1465   | 1490     | 1515      |
| 552 DOUBLE NARROW BASE SIDE DRAWER     | 59 x 73 x 12 | 1225    | 1320                  | 1415   | 1510   | 1605                             | 1700                      | 1065   | 1080     | 1095      |



## 99905 BASE C

### FOR HEADBOARD WITH WINGS

\*Base with legs: Specify leg choice: LG182 wood (colour), LG60 metal or LG189 metal.

\*NB: Narrow bed base for "ADJUSTABLE BED" (items 560-561-563): WOOD leg only (specify colour).

WIDE CONTOUR BASE - WITH LEGS & NO DUST - Posture Board included.

Includes: 3 wood slats and 2 central leg heights: High position at 9.75" (8.25" leg) or low position at 6.5" (5" leg).

WIDE CONTOUR BASE WITH STORAGE - plywood posture board included.

NARROW CONTOUR BASE - posture board included at fixed height of 10,25".

NARROW CONTOUR base for AJDUSTABLE BED: Interior dimensions including headboard depth: King: 78"W x 82"D | Queen: 61"W x 82"D | Single: 40"W x 82"D.

NARROW CONTOUR base with STORAGE: Attn: The contour will be 1" wider to support the storage mechanism.

SIDE DRAWER BASES: King and Queen bases have 2 DRAWERS (1 on each side). / Double and Single bases only have 1 DRAWER. Please specify on your order which side (front view facing).

SIDE DRAWER: Clearance space for night table is minimum 20" from wall.

Birch DRAWER DIMENSIONS for Front & Side Drawers: King & Queen: 54.25"x 24.5" x 5". / Double & Single: 48.25" x 24.5" x 5".

Drawer opened: Leave at least 18" clearance space.

NB: Only bed bases with "Drawers" (frontal or side) can be sold separately. The headboard side of the bed base will not be finished.

| Description                               | L x D x H    | Leather |                       |  |  |                                  |                           | Fabric |          |           |
|---|--------------|---------|-----------------------|--|--|----------------------------------|---------------------------|--------|----------|-----------|
|   |              | 10      | 20<br>Madras<br>Softy | 30<br>Hugo<br>Fantasy<br>Illusion<br>Tucson<br>Utah<br>Vintage<br>Wild Laredo<br>Yukon | 40<br>Elegance<br>Princess<br>Santiago<br>Sensation<br>Sunset<br>Trina<br>Victoria | 50<br>Bull<br>Cassiope<br>Dublin | 60<br>Caress<br>Ultrasued | A      | B<br>COM | C<br>alta |
| 553 SINGLE NARROW BASE SIDE DRAWER        | 44 x 73 x 12 | 1225    | 1310                  | 1395   | 1480   | 1565                             | 1650                      | 1065   | 1080     | 1095      |
| 560 KING NARROW BASE FOR ADJUSTABLE BED   | 82x76x12     | 795     | 905                   | 1015   | 1125   | 1235                             | 1345                      | 635    | 665      | 695       |
| 561 QUEEN NARROW BASE FOR ADJUSTABLE BED  | 65x76x12     | 735     | 835                   | 935  | 1035   | 1135                             | 1235                      | 570    | 590      | 610       |
| 563 SINGLE NARROW BASE FOR ADJUSTABLE BED | 44x76x12     | 575     | 655                   | 735  | 815  | 895                              | 975                       | 510    | 525      | 540       |





# 99905

**BASE pour tête de lit AVEC oreilles**  
Bed base for headboard WITH wings

## 4" Base contour LARGE | WIDE contour Base

### DIMENSIONS

Base de lits seulement  
Bed base only

**L x P/D x H**

|          |                 |
|----------|-----------------|
| <b>K</b> | 87" x 79" x 12" |
| <b>Q</b> | 69" x 79" x 12" |
| <b>D</b> | 64" x 75" x 12" |
| <b>S</b> | 49" x 75" x 12" |



**\*Avec pattes | \*With Legs**  
**K 410 - Q 411 - D 412 - S 413**

2 positions de matelas à 9,75" ou 6,5" du plancher  
2 mattress position from 9,75" or 6,5" from the floor



**Anti-poussière | No Dust**  
**K 420 - Q 421 - D 422 - S 423**

2 positions de matelas à 9,75" ou 6,5" du plancher  
2 mattress position from 9,75" or 6,5" from the floor



**Avec rangement | With Storage**  
**K 430 - Q 431**

1 position de matelas à 10,25" du plancher  
1 mattress position at 10,25" from floor



**Rangement à tiroir frontal**  
**With Front Drawer**  
**K 440 - Q 441 - D 442**

1 position de matelas à 10,25" du plancher  
1 mattress position at 10,25" from floor



**Rangement à tiroir latéraux**  
**With Side Drawers**  
**K 450 - Q 451 (2 tiroirs | drawers)**  
**D 452 - S 453 (1 tiroir | drawer)**

1 position de matelas à 10,25" du plancher  
1 mattress position at 10,25" from floor

## 2" Base contour MINCE | NARROW contour Base

### DIMENSIONS

Base de lits seulement  
Bed base only

**L x P/D x H**

|          |                 |
|----------|-----------------|
| <b>K</b> | 82" x 77" x 12" |
| <b>Q</b> | 64" x 77" x 12" |
| <b>D</b> | 59" x 73" x 12" |
| <b>S</b> | 44" x 73" x 12" |



**\*Avec pattes | \*With Legs**  
**K 510 - Q 511 - D 512 - S 513**

1 position de matelas à 10,25" du plancher  
1 mattress position at 10,25" from floor



**Anti-poussière | No Dust**  
**K 520 - Q 521 - D 522 - S 523**

1 position de matelas à 10,25" du plancher  
1 mattress position at 10,25" from floor

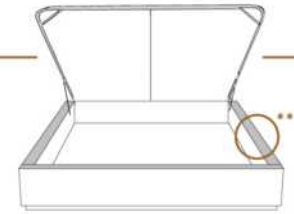

**Avec rangement | With Storage**  
**\*\*1" plus large | \*\*1" wider**  
**K 530 - Q 531**

1 position de matelas à 10,25" du plancher  
1 mattress position at 10,25" from floor



**Lit réglable | Adjustable bed**  
**Pattes de bois seulement | Wood leg only**  
**K 560 - Q 561 - S 563**

|      | King     | Queen    | Simple Single |
|------|----------|----------|---------------|
| EXT: | 87x89x56 | 69x89x56 | 49x89x56      |
| INT: | 78x82x12 | 61x82x12 | 40x82x12      |



**Rangement à tiroir frontal**  
**With Front Drawer**  
**K 540 - Q 541 - D 542**

1 position de matelas à 10,25" du plancher  
1 mattress position at 10,25" from floor



**Rangement à tiroir latéraux**  
**With Side Drawers**  
**K 550 - Q 551 (2 tiroirs | drawers)**  
**D 552 - S 553 (1 tiroir | drawer)**

1 position de matelas à 10,25" du plancher  
1 mattress position at 10,25" from floor

Les illustrations sont génériques et n'indiquent pas tous les détails de coutures. | The sketches are generic and do not reflect all sewing details.

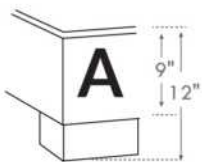

LG182 Bois | Wood

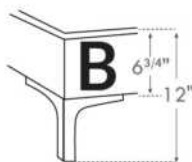

LG60 Metal

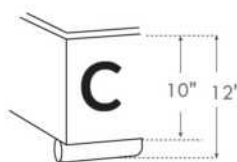

LG189 Metal

**\*Choix de pattes (Seulement pour base avec pattes)**  
**\*Leg choices (Only for Bed base with legs)**

## N.B.

La hauteur du pied et longeron varie selon la patte choisie.  
Foot & siderail height varies according to leg choice.



Lits rembourrés  
*Upholstered Beds*

## CDN Price List



## ALONZO

### GROUP B

Headboard with NO wings - Choose your bed base - See 99900 BASE L price list.

### OPTIONS:

Decorative Nails: MEDIUM ½" nails around contour of appliqué, ADD: King \$100, Queen \$95, Double \$90, Simple \$80.  
Specify nail colour on your order: BRASS-SILVER-PEWTER or COPPER.

COMBO available: Appliqué can be made with contrasting colour. Refer to "COMBO" chart in Product Knowledge booklet.

### Finished BACK of HEADBOARD add:

- in LEATHER: King \$175, Queen \$145, Double \$135, Single \$105.
- in FABRIC: King \$55, Queen \$50, Double \$45, Single \$35.

| Description          | L x D x H | Leather |                       |  |   |                                  |                           | Fabric |          |           |
|----------------------|-----------|---------|-----------------------|--|---|----------------------------------|---------------------------|--------|----------|-----------|
|                      |           | 10      | 20<br>Madras<br>Softy | 30<br>Hugo<br>Fantasy<br>Illusion<br>Tucson<br>Utah<br>Vintage<br>Wild Laredo<br>Yukon | 40<br>Elegance<br>Princess<br>Santiago<br>Sensation | 50<br>Bull<br>Cassiope<br>Dublin | 60<br>Caress<br>Ultrasued | A      | B<br>COM | C<br>alta |
| 400 KING HEADBOARD   | 87X5X56   | 1500    | 1640                  | 1780   | 1920  | 2060                             | 2200                      | 815    | 865      | 915       |
| 401 QUEEN HEADBOARD  | 69X5X56   | 1255    | 1360                  | 1465   | 1570  | 1675                             | 1780                      | 655    | 685      | 715       |
| 402 DOUBLE HEADBOARD | 64X5X56   | 1205    | 1305                  | 1405   | 1505  | 1605                             | 1705                      | 590    | 615      | 640       |
| 403 SINGLE HEADBOARD | 49X5X56   | 1050    | 1150                  | 1250   | 1350  | 1450                             | 1550                      | 395    | 415      | 435       |

# ALONZO

Tête de lit **sans oreilles** | Headboard **without wings**

400 King - 401 Queen - 402 Double - 403 Simple | Single

Pour les dimensions des bases; Voir la liste de prix 99900  
For the dimensions of the bed bases; See Price list 99900

Option de clous | Nail options



Silver - Copper - Pewter - Brass  
1/2" diamètre



## 4" Base contour LARGE | WIDE contour Base

### DIMENSIONS

Lit grandeur complète  
Complete bed size

Base: 12" Haut | Height

L x P/D x H

|   |                 |
|---|-----------------|
| K | 87" x 91" x 56" |
| Q | 69" x 91" x 56" |
| D | 64" x 87" x 56" |
| S | 49" x 87" x 56" |



\*Avec pattes | \*With Legs  
K 410 - Q 411 - D 412 - S 413

2 positions de matelas à 9,75" ou 6,5" du plancher  
2 mattress position from 9,75" or 6,5" from the floor



Anti-poussière | No Dust  
K 420 - Q 421 - D 422 - S 423

2 positions de matelas à 9,75" ou 6,5" du plancher  
2 mattress position from 9,75" or 6,5" from the floor

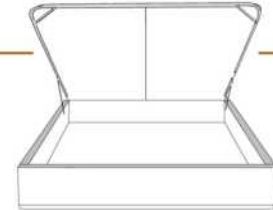

Avec rangement | With Storage  
K 430 - Q 431

1 position de matelas à 10,25" du plancher  
1 mattress position at 10,25" from the floor



Rangement à tiroir frontal  
With Front Drawer  
K 440 - Q 441 - D 442

1 position de matelas à 10,25" du plancher  
1 mattress position at 10,25" from floor



Rangement à tiroir latéraux  
With Side Drawers  
K 450 - Q 451 (2 tiroirs | drawers)  
D 452 - S 453 (1 tiroir | drawer)

1 position de matelas à 10,25" du plancher  
1 mattress position at 10,25" from floor

## 2" Base contour MINCE | NARROW contour Base

### DIMENSIONS

Lit grandeur complète  
Complete bed size

Base: 12" Haut | Height

L x P/D x H

|   |                 |
|---|-----------------|
| K | 87" x 89" x 56" |
| Q | 69" x 89" x 56" |
| D | 64" x 85" x 56" |
| S | 49" x 85" x 56" |



\*Avec pattes | \*With Legs  
K 510 - Q 511 - D 512 - S 513

1 position de matelas à 10,25" du plancher  
1 mattress position at 10,25" from floor



Anti-poussière | No Dust  
K 520 - Q 521 - D 522 - S 523

1 position de matelas à 10,25" du plancher  
1 mattress position at 10,25" from floor

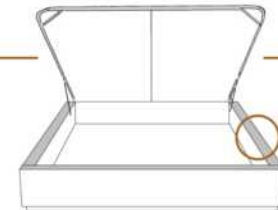

Avec rangement | With Storage  
\*\*1" plus large | \*\*1" wider  
K 530 - Q 531

1 position de matelas à 10,25" du plancher  
1 mattress position at 10,25" from floor



Lit réglable | Adjustable bed  
Pattes de bois seulement | Wood leg only  
K 560 - Q 561 - S 563

|      |          |          |               |
|------|----------|----------|---------------|
|      | King     | Queen    | Simple Single |
| EXT: | 87x89x56 | 69x89x56 | 49x89x56      |
| INT: | 78x82x12 | 61x82x12 | 40x82x12      |



Rangement à tiroir frontal  
With Front Drawer  
K 540 - Q 541 - D 542

1 position de matelas à 10,25" du plancher  
1 mattress position at 10,25" from floor



Rangement à tiroir latéraux  
With Side Drawers  
K 550 - Q 551 (2 tiroirs | drawers)  
D 552 - S 553 (1 tiroir | drawer)

1 position de matelas à 10,25" du plancher  
1 mattress position at 10,25" from floor

Les illustrations sont génériques et n'indiquent pas tous les détails de coutures. | The sketches are generic and do not reflect all sewing details.





Lits rembourrés  
*Upholstered Beds*

## CDN Price List



## AMELIE

### GROUP C

Headboard WITH WINGS - Choose your bed base - See 99905 BASE C price list.

### OPTIONS:

Decorative Nails: 2 rows of MEDIUM ½" nails on front of headboard wing (superior & inferior sides), ADD \$90.  
Specify nail colour on your order: BRASS-SILVER-PEWTER or COPPER.

Finished BACK of HEADBOARD add:

In FABRIC: King \$55, Queen \$50, Double \$45, Single \$35.

| Description          | L x D x H | Leather |                       |  |  |                                  |                           | Fabric |          |           |
|----------------------|-----------|---------|-----------------------|--|--|----------------------------------|---------------------------|--------|----------|-----------|
|                      |           | 10      | 20<br>Madras<br>Softy | 30<br>Hugo<br>Fantasy<br>Illusion<br>Tucson<br>Utah<br>Vintage<br>Wild Laredo<br>Yukon | 40<br>Elegance<br>Princess<br>Santiago<br>Sensation<br>Sunset<br>Trina<br>Victoria | 50<br>Bull<br>Cassiope<br>Dublin | 60<br>Caress<br>Ultrasued | A      | B<br>COM | C<br>alta |
| 400 KING HEADBOARD   | 87x11x47  |         |                       |  |  |                                  |                           | 1060   | 1115     | 1170      |
| 401 QUEEN HEADBOARD  | 69x11x47  |         |                       |  |  |                                  |                           | 900    | 950      | 1000      |
| 402 DOUBLE HEADBOARD | 64x11x47  |         |                       |  |  |                                  |                           | 825    | 870      | 915       |
| 403 SINGLE HEADBOARD | 49x11x47  |         |                       |  |  |                                  |                           | 655    | 685      | 715       |

# AMELIE

Tête de lit avec oreilles | Headboard with wings

400 King - 401 Queen - 402 Double - 403 Simple | Single

Pour les dimensions des bases; Voir la liste de prix 99905  
For the dimensions of the bed bases; See Price list 99905

Option de clous | Nail options



Silver - Copper - Pewter - Brass  
1/2" diamètre



## 4" Base contour LARGE | WIDE contour Base

### DIMENSIONS

Lit grandeur complète  
Complete bed size

Base: 12" Haut | Height

L x P/D x H

|   |                 |
|---|-----------------|
| K | 87" x 90" x 47" |
| Q | 69" x 90" x 47" |
| D | 64" x 86" x 47" |
| S | 49" x 86" x 47" |



\* Avec pattes | \*With Legs  
K 410 - Q 411 - D 412 - S 413

2 positions de matelas à 9,75" ou 6,5" du plancher  
2 mattress position from 9,75" or 6,5" from the floor



Anti-poussière | No Dust  
K 420 - Q 421 - D 422 - S 423

2 positions de matelas à 9,75" ou 6,5" du plancher  
2 mattress position from 9,75" or 6,5" from the floor

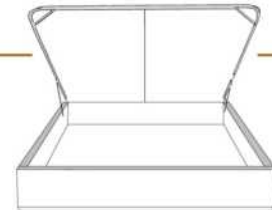

Avec rangement | With Storage  
K 430 - Q 431

1 position de matelas à 10,25" du plancher  
1 mattress position at 10,25" from the floor



Rangement à tiroir frontal  
With Front Drawer  
K 440 - Q 441 - D 442

1 position de matelas à 10,25" du plancher  
1 mattress position at 10,25" from floor



Rangement à tiroir latéraux  
With Side Drawers  
K 450 - Q 451 (2 tiroirs | drawers)  
D 452 - S 453 (1 tiroir | drawer)

1 position de matelas à 10,25" du plancher  
1 mattress position at 10,25" from floor

## 2" Base contour MINCE | NARROW contour Base

### DIMENSIONS

Lit grandeur complète  
Complete bed size

Base: 12" Haut | Height

L x P/D x H

|   |                 |
|---|-----------------|
| K | 87" x 88" x 47" |
| Q | 69" x 88" x 47" |
| D | 64" x 84" x 47" |
| S | 49" x 84" x 47" |



\* Avec pattes | \*With Legs  
K 510 - Q 511 - D 512 - S 513

1 position de matelas à 10,25" du plancher  
1 mattress position at 10,25" from floor



Anti-poussière | No Dust  
K 520 - Q 521 - D 522 - S 523

1 position de matelas à 10,25" du plancher  
1 mattress position at 10,25" from floor

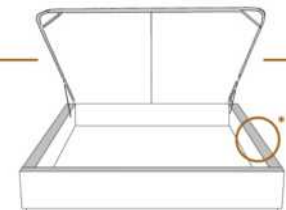

Avec rangement | With Storage  
\*\*1" plus large | \*\*1" wider  
K 530 - Q 531

1 position de matelas à 10,25" du plancher  
1 mattress position at 10,25" from floor



Lit réglable | Adjustable bed  
Pattes de bois seulement | Wood leg only  
K 560 - Q 561 - S 563

|      |          |          |               |
|------|----------|----------|---------------|
|      | King     | Queen    | Simple Single |
| EXT: | 87x87x47 | 69x87x47 | 49x87x47      |
| INT: | 78x82x12 | 61x82x12 | 40x82x12      |



Rangement à tiroir frontal  
With Front Drawer  
K 540 - Q 541 - D 542

1 position de matelas à 10,25" du plancher  
1 mattress position at 10,25" from floor



Rangement à tiroir latéraux  
With Side Drawers  
K 550 - Q 551 (2 tiroirs | drawers)  
D 552 - S 553 (1 tiroir | drawer)

1 position de matelas à 10,25" du plancher  
1 mattress position at 10,25" from floor

Les illustrations sont génériques et n'indiquent pas tous les détails de coutures. | The sketches are generic and do not reflect all sewing details.



## BEATRICE

**GROUP B**

Headboard with NO wings - Choose your bed base - See 99900 BASE L price list.

**OPTIONS:**

Decorative Nails: MEDIUM ½" nails around contour of appliqué, ADD: King \$105, Queen \$100, Double \$95, Simple \$85.  
Specify nail colour on your order: BRASS-SILVER-PEWTER or COPPER.

COMBO available: Appliqué can be made with contrasting colour. Refer to "COMBO" chart in Product Knowledge booklet.

Finished BACK of HEADBOARD add:

- in LEATHER: King \$175, Queen \$145, Double \$135, Single \$105.
- in FABRIC: King \$55, Queen \$50, Double \$45, Single \$35.

| Description          | L x D x H | Leather |                       |  |   |                                  |                           | Fabric |          |           |
|----------------------|-----------|---------|-----------------------|--|---|----------------------------------|---------------------------|--------|----------|-----------|
|                      |           | 10      | 20<br>Madras<br>Softy | 30<br>Hugo<br>Fantasy<br>Illusion<br>Tucson<br>Utah<br>Vintage<br>Wild Laredo<br>Yukon | 40<br>Elegance<br>Princess<br>Santiago<br>Sensation | 50<br>Bull<br>Cassiope<br>Dublin | 60<br>Caress<br>Ultrasued | A      | B<br>COM | C<br>alta |
| 400 KING HEADBOARD   | 87X5X56   | 1500    | 1640                  | 1780   | 1920  | 2060                             | 2200                      | 815    | 865      | 915       |
| 401 QUEEN HEADBOARD  | 69X5X56   | 1255    | 1360                  | 1465   | 1570  | 1675                             | 1780                      | 655    | 685      | 715       |
| 402 DOUBLE HEADBOARD | 64X5X56   | 1205    | 1305                  | 1405   | 1505  | 1605                             | 1705                      | 590    | 615      | 640       |
| 403 SINGLE HEADBOARD | 49X5X56   | 1050    | 1150                  | 1250   | 1350  | 1450                             | 1550                      | 395    | 415      | 435       |

# BEATRICE

Tête de lit sans oreilles | Headboard without wings

400 King - 401 Queen - 402 Double - 403 Simple | Single

Pour les dimensions des bases; Voir la liste de prix 99900  
For the dimensions of the bed bases; See Price list 99900

Option de clous | Nail options



Silver - Copper - Pewter - Brass  
1/2" diamètre



## 4" Base contour LARGE | WIDE contour Base

### DIMENSIONS

Lit grandeur complète  
Complete bed size

Base: 12" Haut | Height

L x P/D x H

|   |                 |
|---|-----------------|
| K | 87" x 91" x 56" |
| Q | 69" x 91" x 56" |
| D | 64" x 87" x 56" |
| S | 49" x 87" x 56" |



\* Avec pattes | \* With Legs  
K 410 - Q 411 - D 412 - S 413

2 positions de matelas à 9,75" ou 6,5" du plancher  
2 mattress position from 9,75" or 6,5" from the floor



Anti-poussière | No Dust  
K 420 - Q 421 - D 422 - S 423

2 positions de matelas à 9,75" ou 6,5" du plancher  
2 mattress position from 9,75" or 6,5" from the floor

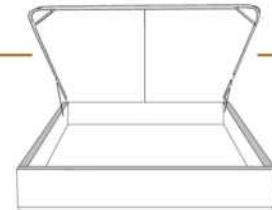

Avec rangement | With Storage  
K 430 - Q 431

1 position de matelas à 10,25" du plancher  
1 mattress position at 10,25" from the floor



Rangement à tiroir frontal  
With Front Drawer  
K 440 - Q 441 - D 442

1 position de matelas à 10,25" du plancher  
1 mattress position at 10,25" from the floor



Rangement à tiroir latéraux  
With Side Drawers  
K 450 - Q 451 (2 tiroirs | drawers)  
D 452 - S 453 (1 tiroir | drawer)

1 position de matelas à 10,25" du plancher  
1 mattress position at 10,25" from the floor

## 2" Base contour MINCE | NARROW contour Base

### DIMENSIONS

Lit grandeur complète  
Complete bed size

Base: 12" Haut | Height

L x P/D x H

|   |                 |
|---|-----------------|
| K | 87" x 89" x 56" |
| Q | 69" x 89" x 56" |
| D | 64" x 85" x 56" |
| S | 49" x 85" x 56" |



\* Avec pattes | \* With Legs  
K 510 - Q 511 - D 512 - S 513

1 position de matelas à 10,25" du plancher  
1 mattress position at 10,25" from the floor



Anti-poussière | No Dust  
K 520 - Q 521 - D 522 - S 523

1 position de matelas à 10,25" du plancher  
1 mattress position at 10,25" from the floor

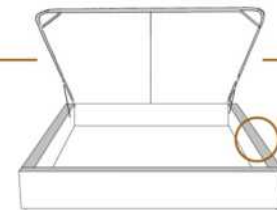

Avec rangement | With Storage  
\*\*1" plus large | \*\*1" wider  
K 530 - Q 531

1 position de matelas à 10,25" du plancher  
1 mattress position at 10,25" from the floor



Lit réglable | Adjustable bed  
Pattes de bois seulement | Wood leg only  
K 560 - Q 561 - S 563

|      |          |          |               |
|------|----------|----------|---------------|
|      | King     | Queen    | Simple Single |
| EXT: | 87x89x56 | 69x89x56 | 49x89x56      |
| INT: | 78x82x12 | 61x82x12 | 40x82x12      |



Rangement à tiroir frontal  
With Front Drawer  
K 540 - Q 541 - D 542

1 position de matelas à 10,25" du plancher  
1 mattress position at 10,25" from the floor



Rangement à tiroir latéraux  
With Side Drawers  
K 550 - Q 551 (2 tiroirs | drawers)  
D 552 - S 553 (1 tiroir | drawer)

1 position de matelas à 10,25" du plancher  
1 mattress position at 10,25" from the floor

Les illustrations sont génériques et n'indiquent pas tous les détails de coutures. | The sketches are generic and do not reflect all sewing details.



## BRIDGE BED

Decorative Pillows: Decorative pillows are not included with this model.

Features: Bed has channel on its perimeter where backs and Traycool niteshelves can be inserted.

Metal legs LG125: Polished aluminum legs.

IMPORTANT: Specify color of generic wood legs LG113.

Each bed base includes 1 posture board.

Recommended size mattress: 8 to 10 inches thick.

| Description                 | L x D x H     | Leather |                       |  |  |                                  |                           | Fabric |          |           |
|-----------------------------|---------------|---------|-----------------------|--|--|----------------------------------|---------------------------|--------|----------|-----------|
|                             |               | 10      | 20<br>Madras<br>Softy | 30<br>Hugo<br>Fantasy<br>Illusion<br>Tucson<br>Utah<br>Vintage<br>Wild Laredo<br>Yukon | 40<br>Elegance<br>Princess<br>Santiago<br>Sensation<br>Sunset<br>Trina<br>Victoria | 50<br>Bull<br>Cassiope<br>Dublin | 60<br>Caress<br>Ultrasued | A      | B<br>COM | C<br>alta |
| 131 BED BACK                | 28X11X18      | 325     | 385                   | 445  | 505  | 565                              | 625                       | 195    | 215      | 235       |
| 150 LARGE PILLOW            | 22X22         |         |                       |  |  |                                  |                           | 75     | 100      | 125       |
| 314 SINGLE BED              | 56x92x13.5/33 | 1325    | 1490                  | 1655   | 1820   | 1985                             | 2150                      | 1030   | 1090     | 1150      |
| 321 TRAYNITE *WOOD*         | 16DIAM.X15    | 120     | 120                   | 120  | 120  | 120                              | 120                       | 120    | 120      | 120       |
| 322 TRAYCOOL *WOOD & METAL* | 16DIAM. X15   | 120     | 120                   | 120  | 120  | 120                              | 120                       | 120    | 120      | 120       |
| 360 QUEEN BED               | 77x97x13.5/33 | 1395    | 1575                  | 1755   | 1935   | 2115                             | 2295                      | 1070   | 1135     | 1200      |
| 380 KING BED                | 95x97x13.5/33 | 1615    | 1815                  | 2015   | 2215   | 2415                             | 2615                      | 1185   | 1260     | 1335      |

# BRIDGE

Lit bridge *Bed items*

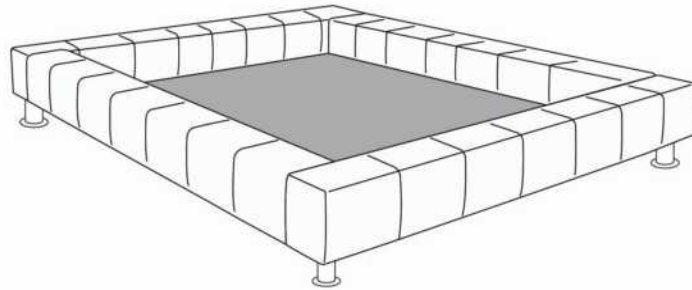

Base de Lit/*Bed base*

372 California King (US only/*seulement*) | 380 King | 360 Queen | 314 Simple/*Single*



Grand Coussin/*Large pillow*  
150

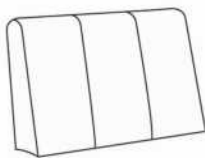

Dos lit/*Bed back*  
131



Traynite  
321



Traycool  
322

Les illustrations sont génériques et n'indiquent pas tous les détails de coutures.  
*The sketches are generic and do not reflect all sewing details.*

R2014-03



Lits rembourrés  
*Upholstered Beds*

## CDN Price List



## CALYPSO

### GROUP A

Headboard with NO wings - Choose your bed base - See 99900 BASE L price list.

### OPTIONS:

Decorative Nails: MEDIUM ½" nails around contour of appliqué, ADD: King \$100, Queen \$95, Double \$90, Simple \$80.  
Specify nail colour on your order: BRASS-SILVER-PEWTER or COPPER.

COMBO available: Appliqué can be made with contrasting colour. Refer to "COMBO" chart in Product Knowledge booklet.

### Finished BACK of HEADBOARD add:

- in LEATHER: King \$175, Queen \$145, Double \$135, Single \$105.
- in FABRIC: King \$55, Queen \$50, Double \$45, Single \$35.

| Description          | L x D x H | Leather |                       |  |   |                                  |                           | Fabric |          |           |
|----------------------|-----------|---------|-----------------------|--|---|----------------------------------|---------------------------|--------|----------|-----------|
|                      |           | 10      | 20<br>Madras<br>Softy | 30<br>Hugo<br>Fantasy<br>Illusion<br>Tucson<br>Utah<br>Vintage<br>Wild Laredo<br>Yukon | 40<br>Elegance<br>Princess<br>Santiago<br>Sensation | 50<br>Bull<br>Cassiope<br>Dublin | 60<br>Caress<br>Ultrasued | A      | B<br>COM | C<br>alta |
| 400 KING HEADBOARD   | 87X5X49   | 890     | 1005                  | 1120   | 1235  | 1350                             | 1465                      | 565    | 615      | 665       |
| 401 QUEEN HEADBOARD  | 69X5X49   | 805     | 910                   | 1015   | 1120  | 1225                             | 1330                      | 480    | 510      | 540       |
| 402 DOUBLE HEADBOARD | 64X5X49   | 735     | 835                   | 935  | 1035  | 1135                             | 1235                      | 460    | 485      | 510       |
| 403 SINGLE HEADBOARD | 49X5X49   | 675     | 755                   | 835  | 915   | 995                              | 1075                      | 365    | 385      | 405       |



# CALYPSO

Tête de lit **sans oreilles** | Headboard **without wings**

400 King - 401 Queen - 402 Double - 403 Simple | Single

Pour les dimensions des bases; Voir la liste de prix 99900  
For the dimensions of the bed bases; See Price list 99900

Option de clous | Nail options



Silver - Copper - Pewter - Brass  
1/2" diamètre



## 4" Base contour LARGE | WIDE contour Base

### DIMENSIONS

Lit grandeur complète  
Complete bed size

Base: 12" Haut | Height

L x P/D x H

|   |                 |
|---|-----------------|
| K | 87" x 91" x 49" |
| Q | 69" x 91" x 49" |
| D | 64" x 87" x 49" |
| S | 49" x 87" x 49" |



\* Avec pattes | \* With Legs  
K 410 - Q 411 - D 412 - S 413

2 positions de matelas à 9,75" ou 6,5" du plancher  
2 mattress position from 9,75" or 6,5" from the floor



Anti-poussière | No Dust  
K 420 - Q 421 - D 422 - S 423

2 positions de matelas à 9,75" ou 6,5" du plancher  
2 mattress position from 9,75" or 6,5" from the floor

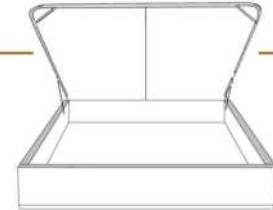

Avec rangement | With Storage  
K 430 - Q 431

1 position de matelas à 10,25" du plancher  
1 mattress position at 10,25" from the floor



Rangement à tiroir frontal  
With Front Drawer  
K 440 - Q 441 - D 442

1 position de matelas à 10,25" du plancher  
1 mattress position at 10,25" from the floor



Rangement à tiroir latéraux  
With Side Drawers  
K 450 - Q 451 (2 tiroirs | drawers)  
D 452 - S 453 (1 tiroir | drawer)

1 position de matelas à 10,25" du plancher  
1 mattress position at 10,25" from the floor

## 2" Base contour MINCE | NARROW contour Base

### DIMENSIONS

Lit grandeur complète  
Complete bed size

Base: 12" Haut | Height

L x P/D x H

|   |                 |
|---|-----------------|
| K | 87" x 89" x 49" |
| Q | 69" x 89" x 49" |
| D | 64" x 85" x 49" |
| S | 49" x 85" x 49" |



\* Avec pattes | \* With Legs  
K 510 - Q 511 - D 512 - S 513

1 position de matelas à 10,25" du plancher  
1 mattress position at 10,25" from the floor



Anti-poussière | No Dust  
K 520 - Q 521 - D 522 - S 523

1 position de matelas à 10,25" du plancher  
1 mattress position at 10,25" from the floor

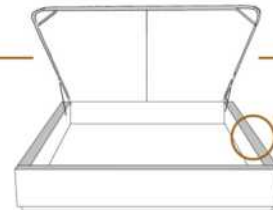

Avec rangement | With Storage  
\*\*1" plus large | \*\*1" wider  
K 530 - Q 531

1 position de matelas à 10,25" du plancher  
1 mattress position at 10,25" from the floor

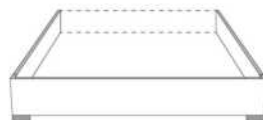

Lit réglable | Adjustable bed  
Pattes de bois seulement | Wood leg only  
K 560 - Q 561 - S 563

|      |          |          |               |
|------|----------|----------|---------------|
|      | King     | Queen    | Simple Single |
| EXT: | 87x89x49 | 69x89x49 | 49x89x49      |
| INT: | 78x82x12 | 61x82x12 | 40x82x12      |



Rangement à tiroir frontal  
With Front Drawer  
K 540 - Q 541 - D 542

1 position de matelas à 10,25" du plancher  
1 mattress position at 10,25" from the floor



Rangement à tiroir latéraux  
With Side Drawers  
K 550 - Q 551 (2 tiroirs | drawers)  
D 552 - S 553 (1 tiroir | drawer)

1 position de matelas à 10,25" du plancher  
1 mattress position at 10,25" from the floor

Les illustrations sont génériques et n'indiquent pas tous les détails de coutures. | The sketches are generic and do not reflect all sewing details.





## CASTLE

### GROUP B

Headboard with NO wings - Choose your bed base - See 99900 BASE L price list.

### OPTIONS:

Decorative Nails: MEDIUM ½" nails around contour of appliqué, ADD: King \$95, Queen \$85, Double \$80, Single \$75.  
Specify nail colour on your order: BRASS-SILVER-PEWTER or COPPER.

COMBO available: Appliqué can be made with contrasting colour. Refer to "COMBO" chart in Product Knowledge booklet.

Finished BACK of HEADBOARD add:

- in LEATHER: King \$175, Queen \$145, Double \$135, Single \$105.
- in FABRIC: King \$55, Queen \$50, Double \$45, Single \$35.

| Description          | L x D x H | Leather |                       |  |   |                                  |                           | Fabric |          |           |
|----------------------|-----------|---------|-----------------------|--|---|----------------------------------|---------------------------|--------|----------|-----------|
|                      |           | 10      | 20<br>Madras<br>Softy | 30<br>Hugo<br>Fantasy<br>Illusion<br>Tucson<br>Utah<br>Vintage<br>Wild Laredo<br>Yukon | 40<br>Elegance<br>Princess<br>Santiago<br>Sensation | 50<br>Bull<br>Cassiope<br>Dublin | 60<br>Caress<br>Ultrasued | A      | B<br>COM | C<br>alta |
| 400 KING HEADBOARD   | 87X5X56   | 1500    | 1640                  | 1780   | 1920  | 2060                             | 2200                      | 815    | 865      | 915       |
| 401 QUEEN HEADBOARD  | 69X5X56   | 1255    | 1360                  | 1465   | 1570  | 1675                             | 1780                      | 655    | 685      | 715       |
| 402 DOUBLE HEADBOARD | 64X5X56   | 1205    | 1305                  | 1405   | 1505  | 1605                             | 1705                      | 590    | 615      | 640       |
| 403 SINGLE HEADBOARD | 49X5X56   | 1050    | 1150                  | 1250   | 1350  | 1450                             | 1550                      | 395    | 415      | 435       |

# CASTLE

Tête de lit **sans oreilles** | Headboard **without wings**

400 King - 401 Queen - 402 Double - 403 Simple | Single

Pour les dimensions des bases; Voir la liste de prix 99900  
For the dimensions of the bed bases; See Price list 99900

Option de clous | Nail options



Silver - Copper - Pewter - Brass  
1/2" diamètre

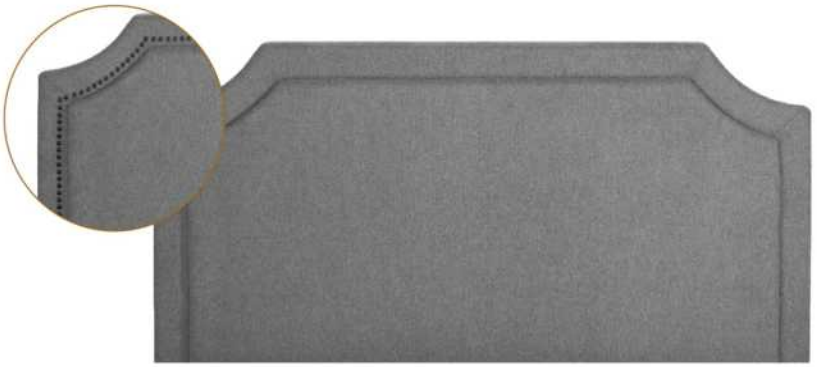

## 4" Base contour LARGE | WIDE contour Base

### DIMENSIONS

Lit grandeur complète  
Complete bed size

Base: 12" Haut | Height

L x P/D x H

|   |                 |
|---|-----------------|
| K | 87" x 91" x 56" |
| Q | 69" x 91" x 56" |
| D | 64" x 87" x 56" |
| S | 49" x 87" x 56" |



\*Avec pattes | \*With Legs  
**K 410 - Q 411 - D 412 - S 413**

2 positions de matelas à 9,75" ou 6,5" du plancher  
2 mattress position from 9,75" or 6,5" from the floor



Anti-poussière | No Dust  
**K 420 - Q 421 - D 422 - S 423**

2 positions de matelas à 9,75" ou 6,5" du plancher  
2 mattress position from 9,75" or 6,5" from the floor

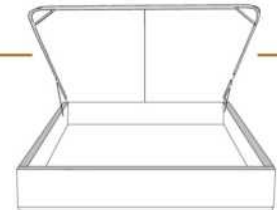

Avec rangement | With Storage  
**K 430 - Q 431**

1 position de matelas à 10,25" du plancher  
1 mattress position at 10,25" from the floor



Rangement à tiroir frontal  
With Front Drawer  
**K 440 - Q 441 - D 442**

1 position de matelas à 10,25" du plancher  
1 mattress position at 10,25" from the floor



Rangement à tiroir latéraux  
With Side Drawers  
**K 450 - Q 451 (2 tiroirs | drawers)  
D 452 - S 453 (1 tiroir | drawer)**

1 position de matelas à 10,25" du plancher  
1 mattress position at 10,25" from the floor

## 2" Base contour MINCE | NARROW contour Base

### DIMENSIONS

Lit grandeur complète  
Complete bed size

Base: 12" Haut | Height

L x P/D x H

|   |                 |
|---|-----------------|
| K | 87" x 89" x 56" |
| Q | 69" x 89" x 56" |
| D | 64" x 85" x 56" |
| S | 49" x 85" x 56" |



\*Avec pattes | \*With Legs  
**K 510 - Q 511 - D 512 - S 513**

1 position de matelas à 10,25" du plancher  
1 mattress position at 10,25" from the floor



Anti-poussière | No Dust  
**K 520 - Q 521 - D 522 - S 523**

1 position de matelas à 10,25" du plancher  
1 mattress position at 10,25" from the floor

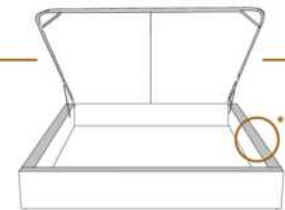

Avec rangement | With Storage  
**\*\*1" plus large | \*\*1" wider  
K 530 - Q 531**

1 position de matelas à 10,25" du plancher  
1 mattress position at 10,25" from the floor



Lit réglable | Adjustable bed  
Pattes de bois seulement | Wood leg only  
**K 560 - Q 561 - S 563**

|      |          |          |               |
|------|----------|----------|---------------|
|      | King     | Queen    | Simple Single |
| EXT: | 87x89x56 | 69x89x56 | 49x89x56      |
| INT: | 78x82x12 | 61x82x12 | 40x82x12      |



Rangement à tiroir frontal  
With Front Drawer  
**K 540 - Q 541 - D 542**

1 position de matelas à 10,25" du plancher  
1 mattress position at 10,25" from the floor



Rangement à tiroir latéraux  
With Side Drawers  
**K 550 - Q 551 (2 tiroirs | drawers)  
D 552 - S 553 (1 tiroir | drawer)**

1 position de matelas à 10,25" du plancher  
1 mattress position at 10,25" from the floor

Les illustrations sont génériques et n'indiquent pas tous les détails de coutures. | The sketches are generic and do not reflect all sewing details.



## CASUAL

### GROUP A

Headboard with NO wings - CHOOSE your BED BASE - See 99900 BASE L price list.

Finished BACK of HEADBOARD add:

- in LEATHER: King \$175, Queen \$145, Double \$135, Single \$105.

- in FABRIC: King \$55, Queen \$50, Double \$45, Single \$35.

| Description          | L x D x H | Leather |                       |  |  |                                  |                           | Fabric |          |           |
|----------------------|-----------|---------|-----------------------|--|--|----------------------------------|---------------------------|--------|----------|-----------|
|                      |           | 10      | 20<br>Madras<br>Softy | 30<br>Hugo<br>Fantasy<br>Illusion<br>Tucson<br>Utah<br>Vintage<br>Wild Laredo<br>Yukon | 40<br>Elegance<br>Princess<br>Santiago<br>Sensation<br>Sunset<br>Trina<br>Victoria | 50<br>Bull<br>Cassiope<br>Dublin | 60<br>Caress<br>Ultrasued | A      | B<br>COM | C<br>alta |
| 400 KING HEADBOARD   | 87X4X49   | 890     | 1005                  | 1120   | 1235   | 1350                             | 1465                      | 565    | 615      | 665       |
| 401 QUEEN HEADBOARD  | 69X4X49   | 805     | 910                   | 1015   | 1120   | 1225                             | 1330                      | 480    | 510      | 540       |
| 402 DOUBLE HEADBOARD | 64X4X49   | 735     | 835                   | 935  | 1035   | 1135                             | 1235                      | 460    | 485      | 510       |
| 403 SINGLE HEADBOARD | 49X4X49   | 675     | 755                   | 835  | 915  | 995                              | 1075                      | 365    | 385      | 405       |

# CASUAL

Tête de lit sans oreilles | Headboard without wings

400 King - 401 Queen - 402 Double - 403 Simple | Single

Pour les dimensions des bases; Voir la liste de prix 99900  
For the dimensions of the bed bases; See Price list 99900



## 4" Base contour LARGE | WIDE contour Base

### DIMENSIONS

Lit grandeur complète  
Complete bed size

Base: 12" Haut | Height

L x P/D x H

|   |                 |
|---|-----------------|
| K | 87" x 90" x 46" |
| Q | 69" x 90" x 46" |
| D | 64" x 86" x 46" |
| S | 49" x 86" x 46" |



\*Avec pattes | \*With Legs  
K 410 - Q 411 - D 412 - S 413

2 positions de matelas à 9,75" ou 6,5" du plancher  
2 mattress position from 9,75" or 6,5" from the floor



Anti-poussière | No Dust  
K 420 - Q 421 - D 422 - S 423

2 positions de matelas à 9,75" ou 6,5" du plancher  
2 mattress position from 9,75" or 6,5" from the floor

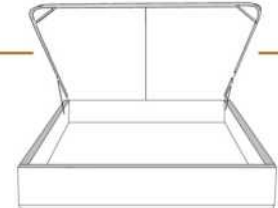

Avec rangement | With Storage  
K 430 - Q 431

1 position de matelas à 10,25" du plancher  
1 mattress position at 10,25" from floor



Rangement à tiroir frontal  
With Front Drawer  
K 440 - Q 441 - D 442

1 position de matelas à 10,25" du plancher  
1 mattress position at 10,25" from floor



Rangement à tiroir latéraux  
With Side Drawers  
K 450 - Q 451 (2 tiroirs | drawers)  
D 452 - S 453 (1 tiroir | drawer)

1 position de matelas à 10,25" du plancher  
1 mattress position at 10,25" from floor

## 2" Base contour MINCE | NARROW contour Base

### DIMENSIONS

Lit grandeur complète  
Complete bed size

Base: 12" Haut | Height

L x P/D x H

|   |                 |
|---|-----------------|
| K | 87" x 88" x 46" |
| Q | 69" x 88" x 46" |
| D | 64" x 84" x 46" |
| S | 49" x 84" x 46" |



\*Avec pattes | \*With Legs  
K 510 - Q 511 - D 512 - S 513

1 position de matelas à 10,25" du plancher  
1 mattress position at 10,25" from floor



Anti-poussière | No Dust  
K 520 - Q 521 - D 522 - S 523

1 position de matelas à 10,25" du plancher  
1 mattress position at 10,25" from floor

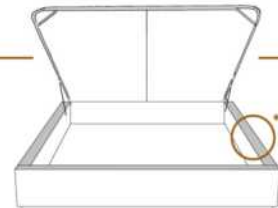

Avec rangement | With Storage  
\*\*1" plus large | \*\*1" wider  
K 530 - Q 531

1 position de matelas à 10,25" du plancher  
1 mattress position at 10,25" from floor



Lit réglable | Adjustable bed  
Pattes de bois seulement | Wood leg only  
K 560 - Q 561 - S 563

|      |          |          |               |
|------|----------|----------|---------------|
|      | King     | Queen    | Simple/Single |
| EXT: | 87x88x49 | 69x88x49 | 49x88x49      |
| INT: | 78x82x12 | 61x82x12 | 40x82x12      |



Rangement à tiroir frontal  
With Front Drawer  
K 540 - Q 541 - D 542

1 position de matelas à 10,25" du plancher  
1 mattress position at 10,25" from floor



Rangement à tiroir latéraux  
With Side Drawers  
K 550 - Q 551 (2 tiroirs | drawers)  
D 552 - S 553 (1 tiroir | drawer)

1 position de matelas à 10,25" du plancher  
1 mattress position at 10,25" from floor

Les illustrations sont génériques et n'indiquent pas tous les détails de coutures. | The sketches are generic and do not reflect all sewing details.



Lits rembourrés  
*Upholstered Beds*

CDN Price List



## CATHERINE

GROUP C

Headboard WITH WINGS - Choose your bed base - See 99905 BASE C price list.

OPTIONS:

Decorative Nails: 2 rows of MEDIUM ½" nails on front of headboard wing (superior & inferior sides & top), ADD \$100.  
Specify nail colour on your order: BRASS-SILVER-PEWTER or COPPER.

Finished BACK of HEADBOARD add:

In FABRIC: King \$55, Queen \$50, Double \$45, Single \$35.

| Description          | L x D x H    | Leather |                       |  |  |                                  |                           | Fabric |          |           |
|----------------------|--------------|---------|-----------------------|--|--|----------------------------------|---------------------------|--------|----------|-----------|
|                      |              | 10      | 20<br>Madras<br>Softy | 30<br>Hugo<br>Fantasy<br>Illusion<br>Tucson<br>Utah<br>Vintage<br>Wild Laredo<br>Yukon | 40<br>Elegance<br>Princess<br>Santiago<br>Sensation<br>Sunset<br>Trina<br>Victoria | 50<br>Bull<br>Cassiope<br>Dublin | 60<br>Caress<br>Ultrasued | A      | B<br>COM | C<br>alta |
| 400 KING HEADBOARD   | 87 x 11 x 56 |         |                       |  |  |                                  |                           | 1060   | 1115     | 1170      |
| 401 QUEEN HEADBOARD  | 69 x 11 x 56 |         |                       |  |  |                                  |                           | 900    | 950      | 1000      |
| 402 DOUBLE HEADBOARD | 64 x 11 x 56 |         |                       |  |  |                                  |                           | 825    | 870      | 915       |
| 403 SINGLE HEADBOARD | 49 x 11 x 56 |         |                       |  |  |                                  |                           | 655    | 685      | 715       |



# CATHERINE

Tête de lit avec oreilles | Headboard with wings

400 King - 401 Queen - 402 Double - 403 Simple | Single

Pour les dimensions des bases; Voir la liste de prix 99905  
For the dimensions of the bed bases; See Price list 99905

Option de clous | Nail options



Silver - Copper - Pewter - Brass  
1/2" diamètre



## 4" Base contour LARGE | WIDE contour Base

### DIMENSIONS

Lit grandeur complète  
Complete bed size

Base: 12" Haut | Height

L x P/D x H

|   |                 |
|---|-----------------|
| K | 87" x 90" x 56" |
| Q | 69" x 90" x 56" |
| D | 64" x 86" x 56" |
| S | 49" x 86" x 56" |



\*Avec pattes | \*With Legs  
K 410 - Q 411 - D 412 - S 413

2 positions de matelas à 9,75" ou 6,5" du plancher  
2 mattress position from 9,75" or 6,5" from the floor



Anti-poussière | No Dust  
K 420 - Q 421 - D 422 - S 423

2 positions de matelas à 9,75" ou 6,5" du plancher  
2 mattress position from 9,75" or 6,5" from the floor

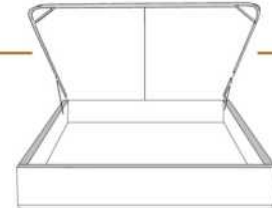

Avec rangement | With Storage  
K 430 - Q 431

1 position de matelas à 10,25" du plancher  
1 mattress position at 10,25" from floor



Rangement à tiroir frontal  
With Front Drawer  
K 440 - Q 441 - D 442

1 position de matelas à 10,25" du plancher  
1 mattress position at 10,25" from floor



Rangement à tiroir latéraux  
With Side Drawers  
K 450 - Q 451 (2 tiroirs | drawers)  
D 452 - S 453 (1 tiroir | drawer)

1 position de matelas à 10,25" du plancher  
1 mattress position at 10,25" from floor

## 2" Base contour MINCE | NARROW contour Base

### DIMENSIONS

Lit grandeur complète  
Complete bed size

Base: 12" Haut | Height

L x P/D x H

|   |                 |
|---|-----------------|
| K | 87" x 88" x 56" |
| Q | 69" x 88" x 56" |
| D | 64" x 84" x 56" |
| S | 49" x 84" x 56" |



\*Avec pattes | \*With Legs  
K 510 - Q 511 - D 512 - S 513

1 position de matelas à 10,25" du plancher  
1 mattress position at 10,25" from floor



Anti-poussière | No Dust  
K 520 - Q 521 - D 522 - S 523

1 position de matelas à 10,25" du plancher  
1 mattress position at 10,25" from floor

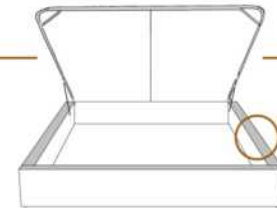

Avec rangement | With Storage  
\*\*1" plus large | \*\*1" wider  
K 530 - Q 531

1 position de matelas à 10,25" du plancher  
1 mattress position at 10,25" from floor



Lit réglable | Adjustable bed  
Pattes de bois seulement | Wood leg only  
K 560 - Q 561 - S 563

|      |          |          |               |
|------|----------|----------|---------------|
|      | King     | Queen    | Simple Single |
| EXT: | 87x87x56 | 69x87x56 | 49x87x56      |
| INT: | 78x82x12 | 61x82x12 | 40x82x12      |



Rangement à tiroir frontal  
With Front Drawer  
K 540 - Q 541 - D 542

1 position de matelas à 10,25" du plancher  
1 mattress position at 10,25" from floor



Rangement à tiroir latéraux  
With Side Drawers  
K 550 - Q 551 (2 tiroirs | drawers)  
D 552 - S 553 (1 tiroir | drawer)

1 position de matelas à 10,25" du plancher  
1 mattress position at 10,25" from floor

Les illustrations sont génériques et n'indiquent pas tous les détails de coutures. | The sketches are generic and do not reflect all sewing details.



Lits rembourrés  
*Upholstered Beds*

## CDN Price List



## CELINE

### GROUP B

Headboard WITH WINGS - Choose your bed base - See 99905 BASE C price list.

### OPTIONS:

Decorative Nails: MEDIUM ½" nails on front of headboard wing and top of headboard, ADD King \$105, Queen \$100, Double \$95, Single \$90.  
Specify nail colour on your order: BRASS-SILVER-PEWTER or COPPER.

Finished BACK of HEADBOARD add:

- in LEATHER: King \$175, Queen \$145, Double \$135, Single \$105.
- in FABRIC: King \$55, Queen \$50, Double \$45, Single \$35.

| Description          | L x D x H | Leather |                       |  |  |                                  |                           | Fabric |          |           |
|----------------------|-----------|---------|-----------------------|--|--|----------------------------------|---------------------------|--------|----------|-----------|
|                      |           | 10      | 20<br>Madras<br>Softy | 30<br>Hugo<br>Fantasy<br>Illusion<br>Tucson<br>Utah<br>Vintage<br>Wild Laredo<br>Yukon | 40<br>Elegance<br>Princess<br>Santiago<br>Sensation<br>Sunset<br>Trina<br>Victoria | 50<br>Bull<br>Cassiope<br>Dublin | 60<br>Caress<br>Ultrasued | A      | B<br>COM | C<br>alta |
| 400 KING HEADBOARD   | 87X11X47  |         |                       |  |  |                                  |                           | 815    | 865      | 915       |
| 401 QUEEN HEADBOARD  | 69X11X47  |         |                       |  |  |                                  |                           | 655    | 685      | 715       |
| 402 DOUBLE HEADBOARD | 64X11X47  |         |                       |  |  |                                  |                           | 590    | 615      | 640       |
| 403 SINGLE HEADBOARD | 49X11X47  |         |                       |  |  |                                  |                           | 395    | 415      | 435       |

# CELINE

Tête de lit avec oreilles | Headboard with wings

400 King - 401 Queen - 402 Double - 403 Simple | Single

Pour les dimensions des bases; Voir la liste de prix 99905  
For the dimensions of the bed bases; See Price list 99905

Option de clous | Nail options



Silver - Copper - Pewter - Brass  
1/2" diamètre



## 4" Base contour LARGE | WIDE contour Base

### DIMENSIONS

Lit grandeur complète  
Complete bed size

Base: 12" Haut | Height

L x P/D x H

|   |                 |
|---|-----------------|
| K | 87" x 90" x 47" |
| Q | 69" x 90" x 47" |
| D | 64" x 86" x 47" |
| S | 49" x 86" x 47" |



\*Avec pattes | \*With Legs  
K 410 - Q 411 - D 412 - S 413

2 positions de matelas à 9,75" ou 6,5" du plancher  
2 mattress position from 9,75" or 6,5" from the floor



Anti-poussière | No Dust  
K 420 - Q 421 - D 422 - S 423

2 positions de matelas à 9,75" ou 6,5" du plancher  
2 mattress position from 9,75" or 6,5" from the floor

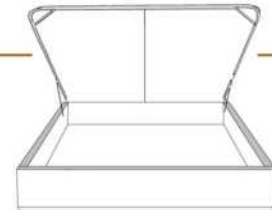

Avec rangement | With Storage  
K 430 - Q 431

1 position de matelas à 10,25" du plancher  
1 mattress position at 10,25" from floor



Rangement à tiroir frontal  
With Front Drawer  
K 440 - Q 441 - D 442

1 position de matelas à 10,25" du plancher  
1 mattress position at 10,25" from floor



Rangement à tiroir latéraux  
With Side Drawers  
K 450 - Q 451 (2 tiroirs | drawers)  
D 452 - S 453 (1 tiroir | drawer)

1 position de matelas à 10,25" du plancher  
1 mattress position at 10,25" from floor

## 2" Base contour MINCE | NARROW contour Base

### DIMENSIONS

Lit grandeur complète  
Complete bed size

Base: 12" Haut | Height

L x P/D x H

|   |                 |
|---|-----------------|
| K | 87" x 88" x 47" |
| Q | 69" x 88" x 47" |
| D | 64" x 84" x 47" |
| S | 49" x 84" x 47" |



\*Avec pattes | \*With Legs  
K 510 - Q 511 - D 512 - S 513

1 position de matelas à 10,25" du plancher  
1 mattress position at 10,25" from floor



Anti-poussière | No Dust  
K 520 - Q 521 - D 522 - S 523

1 position de matelas à 10,25" du plancher  
1 mattress position at 10,25" from floor

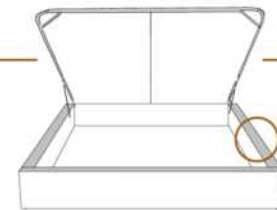

Avec rangement | With Storage  
\*\*1" plus large | \*\*1" wider  
K 530 - Q 531

1 position de matelas à 10,25" du plancher  
1 mattress position at 10,25" from floor



Lit réglable | Adjustable bed  
Pattes de bois seulement | Wood leg only  
K 560 - Q 561 - S 563

|      |          |          |               |
|------|----------|----------|---------------|
|      | King     | Queen    | Simple Single |
| EXT: | 87x87x47 | 69x87x47 | 49x87x47      |
| INT: | 78x82x12 | 61x82x12 | 40x82x12      |



Rangement à tiroir frontal  
With Front Drawer  
K 540 - Q 541 - D 542

1 position de matelas à 10,25" du plancher  
1 mattress position at 10,25" from floor



Rangement à tiroir latéraux  
With Side Drawers  
K 550 - Q 551 (2 tiroirs | drawers)  
D 552 - S 553 (1 tiroir | drawer)

1 position de matelas à 10,25" du plancher  
1 mattress position at 10,25" from floor

Les illustrations sont génériques et n'indiquent pas tous les détails de coutures. | The sketches are generic and do not reflect all sewing details.





Lits rembourrés  
*Upholstered Beds*

## CDN Price List



### CONTEMPO 56" H

**GROUP C**

Headboard WITH WINGS - Choose your bed base - See 99905 BASE C price list.

**OPTIONS:**

Decorative Nails: MEDIUM ½" nails on front of headboard wing, ADD \$50.  
Specify nail colour on your order: BRASS-SILVER-PEWTER or COPPER.

Finished BACK of HEADBOARD add:

- in LEATHER: King \$175, Queen \$145, Double \$135, Single \$105.
- in FABRIC: King \$55, Queen \$50, Double \$45, Single \$35.

| Description          | L x D x H | Leather |                       |  |  |                                  |                           | Fabric |          |           |
|----------------------|-----------|---------|-----------------------|--|--|----------------------------------|---------------------------|--------|----------|-----------|
|                      |           | 10      | 20<br>Madras<br>Softy | 30<br>Hugo<br>Fantasy<br>Illusion<br>Tucson<br>Utah<br>Vintage<br>Wild Laredo<br>Yukon | 40<br>Elegance<br>Princess<br>Santiago<br>Sensation<br>Sunset<br>Trina<br>Victoria | 50<br>Bull<br>Cassiope<br>Dublin | 60<br>Caress<br>Ultrasued | A      | B<br>COM | C<br>alta |
| 400 KING HEADBOARD   | 87X11X56  | 1650    | 1785                  | 1920   | 2055   | 2190                             | 2325                      | 1060   | 1115     | 1170      |
| 401 QUEEN HEADBOARD  | 69X11X56  | 1300    | 1405                  | 1510   | 1615   | 1720                             | 1825                      | 900    | 950      | 1000      |
| 402 DOUBLE HEADBOARD | 64X11X56  | 1245    | 1345                  | 1445   | 1545   | 1645                             | 1745                      | 825    | 870      | 915       |
| 403 SINGLE HEADBOARD | 49X11X56  | 960     | 1040                  | 1120   | 1200   | 1280                             | 1360                      | 655    | 685      | 715       |

# CONTEMPO

Tête de lit avec oreilles | Headboard with wings

400 King - 401 Queen - 402 Double - 403 Simple | Single

Pour les dimensions des bases; Voir la liste de prix 99905  
For the dimensions of the bed bases; See Price list 99905

Option de clous | Nail options



Silver - Copper - Pewter - Brass  
1/2" diamètre



## 4" Base contour LARGE | WIDE contour Base

### DIMENSIONS

Lit grandeur complète  
Complete bed size

Base: 12" Haut | Height

L x P/D x H

K  
Q  
D  
S

87" x 90" x 56"  
69" x 90" x 56"  
64" x 86" x 56"  
49" x 86" x 56"



\* Avec pattes | \* With Legs  
K 410 - Q 411 - D 412 - S 413

2 positions de matelas à 9,75" ou 6,5" du plancher  
2 mattress position from 9,75" or 6,5" from the floor



Anti-poussière | No Dust  
K 420 - Q 421 - D 422 - S 423

2 positions de matelas à 9,75" ou 6,5" du plancher  
2 mattress position from 9,75" or 6,5" from the floor

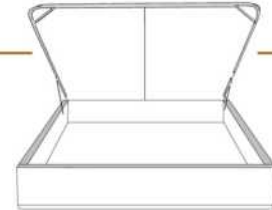

Avec rangement | With Storage  
K 430 - Q 431

1 position de matelas à 10,25" du plancher  
1 mattress position at 10,25" from the floor



Rangement à tiroir frontal  
With Front Drawer  
K 440 - Q 441 - D 442

1 position de matelas à 10,25" du plancher  
1 mattress position at 10,25" from floor



Rangement à tiroir latéraux  
With Side Drawers  
K 450 - Q 451 (2 tiroirs | drawers)  
D 452 - S 453 (1 tiroir | drawer)

1 position de matelas à 10,25" du plancher  
1 mattress position at 10,25" from floor

## 2" Base contour MINCE | NARROW contour Base

### DIMENSIONS

Lit grandeur complète  
Complete bed size

Base: 12" Haut | Height

L x P/D x H

K  
Q  
D  
S

87" x 88" x 56"  
69" x 88" x 56"  
64" x 84" x 56"  
49" x 84" x 56"



\* Avec pattes | \* With Legs  
K 510 - Q 511 - D 512 - S 513

1 position de matelas à 10,25" du plancher  
1 mattress position at 10,25" from floor



Anti-poussière | No Dust  
K 520 - Q 521 - D 522 - S 523

1 position de matelas à 10,25" du plancher  
1 mattress position at 10,25" from floor

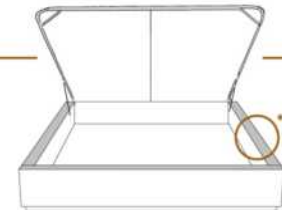

Avec rangement | With Storage  
\*\*1" plus large | \*\*1" wider  
K 530 - Q 531

1 position de matelas à 10,25" du plancher  
1 mattress position at 10,25" from floor



Lit réglable | Adjustable bed  
Pattes de bois seulement | Wood leg only  
K 560 - Q 561 - S 563

|      | King     | Queen    | Simple   Single |
|------|----------|----------|-----------------|
| EXT: | 87x87x56 | 69x87x56 | 49x87x56        |
| INT: | 78x82x12 | 61x82x12 | 40x82x12        |



Rangement à tiroir frontal  
With Front Drawer  
K 540 - Q 541 - D 542

1 position de matelas à 10,25" du plancher  
1 mattress position at 10,25" from floor



Rangement à tiroir latéraux  
With Side Drawers  
K 550 - Q 551 (2 tiroirs | drawers)  
D 552 - S 553 (1 tiroir | drawer)

1 position de matelas à 10,25" du plancher  
1 mattress position at 10,25" from floor

Les illustrations sont génériques et n'indiquent pas tous les détails de coutures. | The sketches are generic and do not reflect all sewing details.



Lits rembourrés  
*Upholstered Beds*

## CDN Price List



### DYLAN 44" H

**GROUP B**

Headboard WITH WINGS - Choose your bed base - See 99905 BASE C price list.

**OPTIONS:**

Decorative Nails: MEDIUM ½" nails on front of headboard wing, ADD \$45.  
Specify nail colour on your order: BRASS-SILVER-PEWTER or COPPER.

Finished BACK of HEADBOARD add:

- in LEATHER: King \$175, Queen \$145, Double \$135, Single \$105.
- in FABRIC: King \$55, Queen \$50, Double \$45, Single \$35.

| Description          | L x D x H | Leather |                       |  |  |                                  |                           | Fabric |          |           |
|----------------------|-----------|---------|-----------------------|--|--|----------------------------------|---------------------------|--------|----------|-----------|
|                      |           | 10      | 20<br>Madras<br>Softy | 30<br>Hugo<br>Fantasy<br>Illusion<br>Tucson<br>Utah<br>Vintage<br>Wild Laredo<br>Yukon | 40<br>Elegance<br>Princess<br>Santiago<br>Sensation<br>Sunset<br>Trina<br>Victoria | 50<br>Bull<br>Cassiope<br>Dublin | 60<br>Caress<br>Ultrasued | A      | B<br>COM | C<br>alta |
| 400 KING HEADBOARD   | 87X11X44  | 1500    | 1640                  | 1780   | 1920   | 2060                             | 2200                      | 815    | 865      | 915       |
| 401 QUEEN HEADBOARD  | 69X11X44  | 1255    | 1360                  | 1465   | 1570   | 1675                             | 1780                      | 655    | 685      | 715       |
| 402 DOUBLE HEADBOARD | 64X11X44  | 1205    | 1305                  | 1405   | 1505   | 1605                             | 1705                      | 590    | 615      | 640       |
| 403 SINGLE HEADBOARD | 49X11X44  | 1050    | 1150                  | 1250   | 1350   | 1450                             | 1550                      | 395    | 415      | 435       |

# DYLAN

Tête de lit avec oreilles | Headboard with wings

400 King - 401 Queen - 402 Double - 403 Simple | Single

Pour les dimensions des bases; Voir la liste de prix 99905  
For the dimensions of the bed bases; See Price list 99905

Option de clous | Nail options



Silver - Copper - Pewter - Brass  
1/2" diamètre

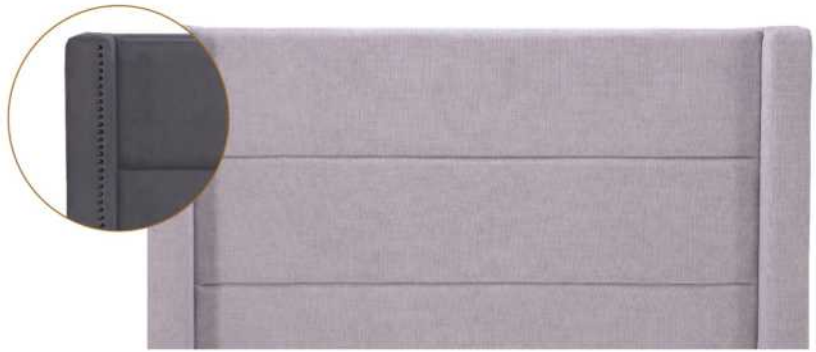

## 4" Base contour LARGE | WIDE contour Base

### DIMENSIONS

Lit grandeur complète  
Complete bed size

Base: 12" Haut | Height

L x P/D x H

K  
Q  
D  
S

87" x 90" x 44"  
69" x 90" x 44"  
64" x 86" x 44"  
49" x 86" x 44"



\* Avec pattes | \* With Legs  
K 410 - Q 411 - D 412 - S 413

2 positions de matelas à 9,75" ou 6,5" du plancher  
2 mattress position from 9,75" or 6,5" from the floor



Anti-poussière | No Dust  
K 420 - Q 421 - D 422 - S 423

2 positions de matelas à 9,75" ou 6,5" du plancher  
2 mattress position from 9,75" or 6,5" from the floor

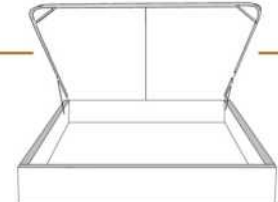

Avec rangement | With Storage  
K 430 - Q 431

1 position de matelas à 10,25" du plancher  
1 mattress position at 10,25" from floor



Rangement à tiroir frontal  
With Front Drawer  
K 440 - Q 441 - D 442

1 position de matelas à 10,25" du plancher  
1 mattress position at 10,25" from floor



Rangement à tiroir latéraux  
With Side Drawers  
K 450 - Q 451 (2 tiroirs | drawers)  
D 452 - S 453 (1 tiroir | drawer)

1 position de matelas à 10,25" du plancher  
1 mattress position at 10,25" from floor

## 2" Base contour MINCE | NARROW contour Base

### DIMENSIONS

Lit grandeur complète  
Complete bed size

Base: 12" Haut | Height

L x P/D x H



\* Avec pattes | \* With Legs  
K 510 - Q 511 - D 512 - S 513

1 position de matelas à 10,25" du plancher  
1 mattress position at 10,25" from floor



Anti-poussière | No Dust  
K 520 - Q 521 - D 522 - S 523

1 position de matelas à 10,25" du plancher  
1 mattress position at 10,25" from floor

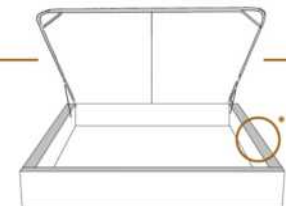

Avec rangement | With Storage  
\*\*1" plus large | \*\*1" wider  
K 530 - Q 531

1 position de matelas à 10,25" du plancher  
1 mattress position at 10,25" from floor



Lit réglable | Adjustable bed  
Pattes de bois seulement | Wood leg only  
K 560 - Q 561 - S 563

|      | King     | Queen    | Simple Single |
|------|----------|----------|---------------|
| EXT: | 87x87x44 | 69x87x44 | 49x87x44      |
| INT: | 78x82x12 | 61x82x12 | 40x82x12      |

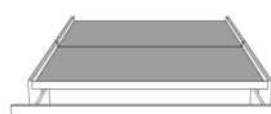

Rangement à tiroir frontal  
With Front Drawer  
K 540 - Q 541 - D 542

1 position de matelas à 10,25" du plancher  
1 mattress position at 10,25" from floor



Rangement à tiroir latéraux  
With Side Drawers  
K 550 - Q 551 (2 tiroirs | drawers)  
D 552 - S 553 (1 tiroir | drawer)

1 position de matelas à 10,25" du plancher  
1 mattress position at 10,25" from floor

Les illustrations sont génériques et n'indiquent pas tous les détails de coutures. | The sketches are generic and do not reflect all sewing details.



Lits rembourrés  
*Upholstered Beds*

## CDN Price List



## FELICITY

### GROUP C

Headboard WITH WINGS - Choose your bed base - See 99905 BASE C price list.

### OPTIONS:

Decorative Nails: MEDIUM ½" nails on front of headboard wing, ADD \$65.  
Specify nail colour on your order: BRASS-SILVER-PEWTER or COPPER.

Finished BACK of HEADBOARD add:

In FABRIC: King \$55, Queen \$50, Double \$45, Single \$35.

| Description          | L x D x H    | Leather |                       |  |  |                                  |                           | Fabric |          |           |
|----------------------|--------------|---------|-----------------------|--|--|----------------------------------|---------------------------|--------|----------|-----------|
|                      |              | 10      | 20<br>Madras<br>Softy | 30<br>Hugo<br>Fantasy<br>Illusion<br>Tucson<br>Utah<br>Vintage<br>Wild Laredo<br>Yukon | 40<br>Elegance<br>Princess<br>Santiago<br>Sensation<br>Sunset<br>Trina<br>Victoria | 50<br>Bull<br>Cassiope<br>Dublin | 60<br>Caress<br>Ultrasued | A      | B<br>COM | C<br>alta |
| 400 KING HEADBOARD   | 87 x 11 x 62 |         |                       |  |  |                                  |                           | 1060   | 1115     | 1170      |
| 401 QUEEN HEADBOARD  | 69 x 11 x 62 |         |                       |  |  |                                  |                           | 900    | 950      | 1000      |
| 402 DOUBLE HEADBOARD | 64 x 11 x 62 |         |                       |  |  |                                  |                           | 825    | 870      | 915       |
| 403 SINGLE HEADBOARD | 49 x 11 x 62 |         |                       |  |  |                                  |                           | 655    | 685      | 715       |



# FELICITY

Tête de lit avec oreilles | Headboard with wings

400 King - 401 Queen - 402 Double - 403 Simple | Single

Pour les dimensions des bases; Voir la liste de prix 99905  
For the dimensions of the bed bases; See Price list 99905

Option de clous | Nail options



Silver - Copper - Pewter - Brass  
1/2" diamètre



## 4" Base contour LARGE | WIDE contour Base

### DIMENSIONS

Lit grandeur complète  
Complete bed size

Base: 12" Haut | Height

L x P/D x H

K  
Q  
D  
S

87" x 90" x 62"  
69" x 90" x 62"  
64" x 86" x 62"  
49" x 86" x 62"



\*Avec pattes | \*With Legs  
K 410 - Q 411 - D 412 - S 413

2 positions de matelas à 9,75" ou 6,5" du plancher  
2 mattress position from 9,75" or 6,5" from the floor



Anti-poussière | No Dust  
K 420 - Q 421 - D 422 - S 423

2 positions de matelas à 9,75" ou 6,5" du plancher  
2 mattress position from 9,75" or 6,5" from the floor

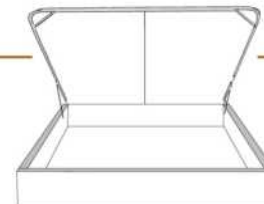

Avec rangement | With Storage  
K 430 - Q 431

1 position de matelas à 10,25" du plancher  
1 mattress position at 10,25" from floor

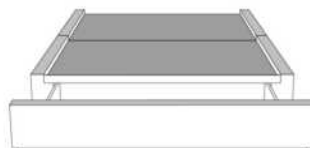

Rangement à tiroir frontal  
With Front Drawer  
K 440 - Q 441 - D 442

1 position de matelas à 10,25" du plancher  
1 mattress position at 10,25" from floor



Rangement à tiroir latéraux  
With Side Drawers  
K 450 - Q 451 (2 tiroirs | drawers)  
D 452 - S 453 (1 tiroir | drawer)

1 position de matelas à 10,25" du plancher  
1 mattress position at 10,25" from floor

## 2" Base contour MINCE | NARROW contour Base

### DIMENSIONS

Lit grandeur complète  
Complete bed size

Base: 12" Haut | Height

L x P/D x H

K  
Q  
D  
S

87" x 88" x 62"  
69" x 88" x 62"  
64" x 84" x 62"  
49" x 84" x 62"



\*Avec pattes | \*With Legs  
K 510 - Q 511 - D 512 - S 513

1 position de matelas à 10,25" du plancher  
1 mattress position at 10,25" from floor



Anti-poussière | No Dust  
K 520 - Q 521 - D 522 - S 523

1 position de matelas à 10,25" du plancher  
1 mattress position at 10,25" from floor

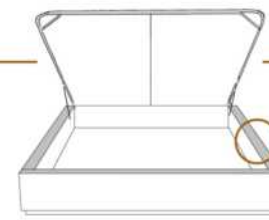

Avec rangement | With Storage  
\*\*1" plus large | \*\*1" wider  
K 530 - Q 531

1 position de matelas à 10,25" du plancher  
1 mattress position at 10,25" from floor

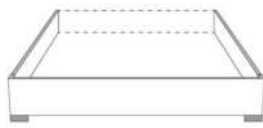

Lit réglable | Adjustable bed  
Pattes de bois seulement | Wood leg only  
K 560 - Q 561 - S 563

|      | King     | Queen    | Simple Single |
|------|----------|----------|---------------|
| EXT: | 87x87x62 | 69x87x62 | 49x87x62      |
| INT: | 78x82x12 | 61x82x12 | 40x82x12      |



Rangement à tiroir frontal  
With Front Drawer  
K 540 - Q 541 - D 542

1 position de matelas à 10,25" du plancher  
1 mattress position at 10,25" from floor



Rangement à tiroir latéraux  
With Side Drawers  
K 550 - Q 551 (2 tiroirs | drawers)  
D 552 - S 553 (1 tiroir | drawer)

1 position de matelas à 10,25" du plancher  
1 mattress position at 10,25" from floor

Les illustrations sont génériques et n'indiquent pas tous les détails de coutures. | The sketches are generic and do not reflect all sewing details.



Lits rembourrés  
*Upholstered Beds*

## CDN Price List



## ISABELLE

### GROUP C

Headboard WITH WINGS. Choose your bed base - See 99905 BASE C price list.

### OPTIONS:

Decorative Nails: LARGE 7/8" nails on OUTER contour of headboard wings ADD \$55.

Specify nail colour: BRASS - SILVER - PEWTER or COPPER.

Finished BACK of HEADBOARD add:

In FABRIC: King \$55, Queen \$50, Double \$45, Single \$35.

| Description          | L x D x H | Leather |                       |  |  |                                  |                           | Fabric |          |           |
|----------------------|-----------|---------|-----------------------|--|--|----------------------------------|---------------------------|--------|----------|-----------|
|                      |           | 10      | 20<br>Madras<br>Softy | 30<br>Hugo<br>Fantasy<br>Illusion<br>Tucson<br>Utah<br>Vintage<br>Wild Laredo<br>Yukon | 40<br>Elegance<br>Princess<br>Santiago<br>Sensation<br>Sunset<br>Trina<br>Victoria | 50<br>Bull<br>Cassiope<br>Dublin | 60<br>Caress<br>Ultrasued | A      | B<br>COM | C<br>alta |
| 400 KING HEADBOARD   | 87X11X56  |         |                       |  |  |                                  |                           | 1060   | 1115     | 1170      |
| 401 QUEEN HEADBOARD  | 69X11X56  |         |                       |  |  |                                  |                           | 900    | 950      | 1000      |
| 402 DOUBLE HEADBOARD | 64X11X56  |         |                       |  |  |                                  |                           | 825    | 870      | 915       |
| 403 SINGLE HEADBOARD | 49X11X56  |         |                       |  |  |                                  |                           | 655    | 685      | 715       |

# ISABELLE

Tête de lit avec oreilles | Headboard with wings

400 King - 401 Queen - 402 Double - 403 Simple | Single

Pour les dimensions des bases; Voir la liste de prix 99905  
For the dimensions of the bed bases; See Price list 99905

Option de clous | Nail options



Silver - Copper - Pewter - Brass  
7/8" diamètre



## 4" Base contour LARGE | WIDE contour Base

### DIMENSIONS

Lit grandeur complète  
Complete bed size

Base: 12" Haut | Height

L x P/D x H

|   |                 |
|---|-----------------|
| K | 87" x 90" x 56" |
| Q | 69" x 90" x 56" |
| D | 64" x 86" x 56" |
| S | 49" x 86" x 56" |



\* Avec pattes | \*With Legs  
K 410 - Q 411 - D 412 - S 413

2 positions de matelas à 9,75" ou 6,5" du plancher  
2 mattress position from 9,75" or 6,5" from the floor



Anti-poussière | No Dust  
K 420 - Q 421 - D 422 - S 423

2 positions de matelas à 9,75" ou 6,5" du plancher  
2 mattress position from 9,75" or 6,5" from the floor



Avec rangement | With Storage  
K 430 - Q 431

1 position de matelas à 10,25" du plancher  
1 mattress position at 10,25" from the floor



Rangement à tiroir frontal  
With Front Drawer  
K 440 - Q 441 - D 442

1 position de matelas à 10,25" du plancher  
1 mattress position at 10,25" from floor



Rangement à tiroir latéraux  
With Side Drawers  
K 450 - Q 451 (2 tiroirs | drawers)  
D 452 - S 453 (1 tiroir | drawer)

1 position de matelas à 10,25" du plancher  
1 mattress position at 10,25" from floor

## 2" Base contour MINCE | NARROW contour Base

### DIMENSIONS

Lit grandeur complète  
Complete bed size

Base: 12" Haut | Height

L x P/D x H

|   |                 |
|---|-----------------|
| K | 87" x 88" x 56" |
| Q | 69" x 88" x 56" |
| D | 64" x 84" x 56" |
| S | 49" x 84" x 56" |



\* Avec pattes | \*With Legs  
K 510 - Q 511 - D 512 - S 513

1 position de matelas à 10,25" du plancher  
1 mattress position at 10,25" from floor



Anti-poussière | No Dust  
K 520 - Q 521 - D 522 - S 523

1 position de matelas à 10,25" du plancher  
1 mattress position at 10,25" from floor

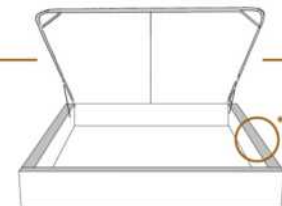

Avec rangement | With Storage  
\*\*1" plus large | \*\*1" wider  
K 530 - Q 531

1 position de matelas à 10,25" du plancher  
1 mattress position at 10,25" from floor



Lit réglable | Adjustable bed  
Pattes de bois seulement | Wood leg only  
K 560 - Q 561 - S 563

|      |          |          |                 |
|------|----------|----------|-----------------|
|      | King     | Queen    | Simple   Single |
| EXT: | 87x87x56 | 69x87x56 | 49x87x56        |
| INT: | 78x82x12 | 61x82x12 | 40x82x12        |



Rangement à tiroir frontal  
With Front Drawer  
K 540 - Q 541 - D 542

1 position de matelas à 10,25" du plancher  
1 mattress position at 10,25" from floor



Rangement à tiroir latéraux  
With Side Drawers  
K 550 - Q 551 (2 tiroirs | drawers)  
D 552 - S 553 (1 tiroir | drawer)

1 position de matelas à 10,25" du plancher  
1 mattress position at 10,25" from floor

Les illustrations sont génériques et n'indiquent pas tous les détails de coutures. | The sketches are generic and do not reflect all sewing details.





Lits rembourrés  
*Upholstered Beds*

## CDN Price List



## JESSICA

### GROUP A

Headboard with NO wings - CHOOSE your BED BASE - See 99900 BASE L price list.

Finished BACK of HEADBOARD add:

- in LEATHER: King \$175, Queen \$145, Double \$135, Single \$105.

- in FABRIC: King \$55, Queen \$50, Double \$45, Single \$35.

| Description          | L x D x H | Leather |                       |  |  |                                  |                           | Fabric |          |           |
|----------------------|-----------|---------|-----------------------|--|--|----------------------------------|---------------------------|--------|----------|-----------|
|                      |           | 10      | 20<br>Madras<br>Softy | 30<br>Hugo<br>Fantasy<br>Illusion<br>Tucson<br>Utah<br>Vintage<br>Wild Laredo<br>Yukon | 40<br>Elegance<br>Princess<br>Santiago<br>Sensation<br>Sunset<br>Trina<br>Victoria | 50<br>Bull<br>Cassiope<br>Dublin | 60<br>Caress<br>Ultrasued | A      | B<br>COM | C<br>alta |
| 400 KING HEADBOARD   | 87X4X49   | 890     | 1005                  | 1120   | 1235   | 1350                             | 1465                      | 565    | 615      | 665       |
| 401 QUEEN HEADBOARD  | 69X4X49   | 805     | 910                   | 1015   | 1120   | 1225                             | 1330                      | 480    | 510      | 540       |
| 402 DOUBLE HEADBOARD | 64X4X49   | 735     | 835                   | 935  | 1035   | 1135                             | 1235                      | 460    | 485      | 510       |
| 403 SINGLE HEADBOARD | 49X4X49   | 675     | 755                   | 835  | 915  | 995                              | 1075                      | 365    | 385      | 405       |

# JESSICA

Tête de lit sans oreilles | Headboard without wings

400 King - 401 Queen - 402 Double - 403 Simple | Single

Pour les dimensions des bases; Voir la liste de prix 99900  
For the dimensions of the bed bases; See Price list 99900



## 4" Base contour LARGE | WIDE contour Base

### DIMENSIONS

Lit grandeur complète  
Complete bed size

Base: 12" Haut | Height

L x P/D x H

K  
Q  
D  
S

87" x 90" x 46"  
69" x 90" x 46"  
64" x 86" x 46"  
49" x 86" x 46"



\*Avec pattes | \*With Legs  
K 410 - Q 411 - D 412 - S 413

2 positions de matelas à 9,75" ou 6,5" du plancher  
2 mattress position from 9,75" or 6,5" from the floor



Anti-poussière | No Dust  
K 420 - Q 421 - D 422 - S 423

2 positions de matelas à 9,75" ou 6,5" du plancher  
2 mattress position from 9,75" or 6,5" from the floor

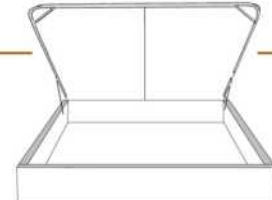

Avec rangement | With Storage  
K 430 - Q 431

1 position de matelas à 10,25" du plancher  
1 mattress position at 10,25" from the floor



Rangement à tiroir frontal  
With Front Drawer  
K 440 - Q 441 - D 442

1 position de matelas à 10,25" du plancher  
1 mattress position at 10,25" from floor



Rangement à tiroir latéraux  
With Side Drawers  
K 450 - Q 451 (2 tiroirs | drawers)  
D 452 - S 453 (1 tiroir | drawer)

1 position de matelas à 10,25" du plancher  
1 mattress position at 10,25" from floor

## 2" Base contour MINCE | NARROW contour Base

### DIMENSIONS

Lit grandeur complète  
Complete bed size

Base: 12" Haut | Height

L x P/D x H

K  
Q  
D  
S

87" x 88" x 46"  
69" x 88" x 46"  
64" x 84" x 46"  
49" x 84" x 46"



\*Avec pattes | \*With Legs  
K 510 - Q 511 - D 512 - S 513

1 position de matelas à 10,25" du plancher  
1 mattress position at 10,25" from floor



Anti-poussière | No Dust  
K 520 - Q 521 - D 522 - S 523

1 position de matelas à 10,25" du plancher  
1 mattress position at 10,25" from floor

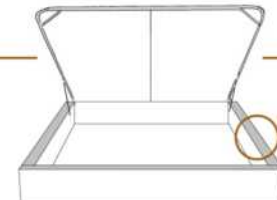

Avec rangement | With Storage  
\*\*1" plus large | \*\*1" wider  
K 530 - Q 531

1 position de matelas à 10,25" du plancher  
1 mattress position at 10,25" from floor



Lit réglable | Adjustable bed  
Pattes de bois seulement | Wood leg only  
K 560 - Q 561 - S 563

|      | King     | Queen    | Simple   Single |
|------|----------|----------|-----------------|
| EXT: | 87x88x49 | 69x88x49 | 49x88x49        |
| INT: | 78x82x12 | 61x82x12 | 40x82x12        |

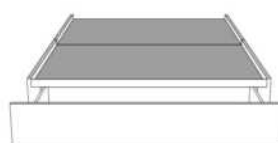

Rangement à tiroir frontal  
With Front Drawer  
K 540 - Q 541 - D 542

1 position de matelas à 10,25" du plancher  
1 mattress position at 10,25" from floor



Rangement à tiroir latéraux  
With Side Drawers  
K 550 - Q 551 (2 tiroirs | drawers)  
D 552 - S 553 (1 tiroir | drawer)

1 position de matelas à 10,25" du plancher  
1 mattress position at 10,25" from floor

Les illustrations sont génériques et n'indiquent pas tous les détails de coutures. | The sketches are generic and do not reflect all sewing details.



Lits rembourrés  
*Upholstered Beds*

## CDN Price List



## KIANA

### GROUP C

\*Headboard WITH NARROW WINGS - See 99905 BASE C price list under .NARROW bed bases.

\*NOTE: This headboard is only available with the NARROW contour bed bases (excludes the narrow base with legs for "Adjustable" beds & the narrow storage bed base).

Finished BACK of HEADBOARD add:

In FABRIC: King \$55, Queen \$50, Double \$45, Single \$35.

| Description          | L x D x H | Leather |                       |  |  |                                  |                           | Fabric |          |           |
|----------------------|-----------|---------|-----------------------|--|--|----------------------------------|---------------------------|--------|----------|-----------|
|                      |           | 10      | 20<br>Madras<br>Softy | 30<br>Hugo<br>Fantasy<br>Illusion<br>Tucson<br>Utah<br>Vintage<br>Wild Laredo<br>Yukon | 40<br>Elegance<br>Princess<br>Santiago<br>Sensation<br>Sunset<br>Trina<br>Victoria | 50<br>Bull<br>Cassiope<br>Dublin | 60<br>Caress<br>Ultrasued | A      | B<br>COM | C<br>alta |
| 400 KING HEADBOARD   | 82x11x65  |         |                       |  |  |                                  |                           | 1060   | 1115     | 1170      |
| 401 QUEEN HEADBOARD  | 64x11x65  |         |                       |  |  |                                  |                           | 900    | 950      | 1000      |
| 402 DOUBLE HEADBOARD | 59x11x65  |         |                       |  |  |                                  |                           | 825    | 870      | 915       |
| 403 SINGLE HEADBOARD | 44x11x65  |         |                       |  |  |                                  |                           | 655    | 685      | 715       |

# KIANA

Tête de lit avec oreilles | Headboard with wings

400 King - 401 Queen - 402 Double - 403 Simple | Single

Pour les dimensions des bases; Voir la liste de prix 99905  
For the dimensions of the bed bases; See Price list 99905

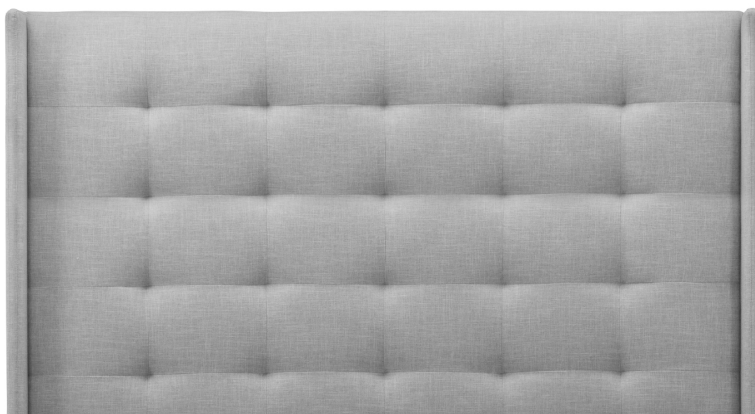

## 2" Base contour MINCE | NARROW contour Base

### DIMENSIONS

Lit grandeur complète  
Complete bed size

Base: 12" Haut | Height

#### L x P/D x H

K  
Q  
D  
S

82" x 88" x 65"

64" x 88" x 65"

59" x 84" x 65"

44" x 84" x 65"

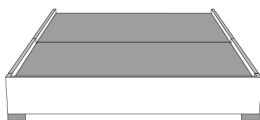

\*Avec pattes | \*With Legs  
K 510 - Q 511 - D 512 - S 513

1 position de matelas à 10,25" du plancher  
1 mattress position at 10,25" from floor



Anti-poussière | No Dust  
K 520 - Q 521 - D 522 - S 523

1 position de matelas à 10,25" du plancher  
1 mattress position at 10,25" from floor



Rangement à tiroir frontal  
With Front Drawer  
K 540 - Q 541 - D 542

1 position de matelas à 10,25" du plancher  
1 mattress position at 10,25" from floor



Rangement à tiroir latéraux  
With Side Drawers  
K 550 - Q 551 (2 tiroirs | drawers)  
D 552 - S 553 (1 tiroir | drawer)

1 position de matelas à 10,25" du plancher  
1 mattress position at 10,25" from floor

Les illustrations sont génériques et n'indiquent pas tous les détails de coutures. | The sketches are generic and do not reflect all sewing details.



Lits rembourrés  
*Upholstered Beds*

## CDN Price List



## LINE

### GROUP B

Headboard WITH WINGS. Choose your bed base - See 99905 B ASE C price list.

### OPTIONS:

Decorative Nails: MEDIUM 1/2" nails on OUTER front of wings & TOP of headboard. ADD King \$105, Queen \$100, Double \$95, Simple \$90.  
SPECIFY nail colour: BRASS - SILVER - PEWTER or COPPER.

Finished BACK of HEADBOARD add:

- in LEATHER: King \$175, Queen \$145, Double \$135, Single \$105.
- in FABRIC: King \$55, Queen \$50, Double \$45, Single \$35.

| Description          | L x D x H | Leather |                       |  |  |                                  |                           | Fabric |          |           |
|----------------------|-----------|---------|-----------------------|--|--|----------------------------------|---------------------------|--------|----------|-----------|
|                      |           | 10      | 20<br>Madras<br>Softy | 30<br>Hugo<br>Fantasy<br>Illusion<br>Tucson<br>Utah<br>Vintage<br>Wild Laredo<br>Yukon | 40<br>Elegance<br>Princess<br>Santiago<br>Sensation<br>Sunset<br>Trina<br>Victoria | 50<br>Bull<br>Cassiope<br>Dublin | 60<br>Caress<br>Ultrasued | A      | B<br>COM | C<br>alta |
| 400 KING HEADBOARD   | 87X11X47  | 1500    | 1640                  | 1780   | 1920   | 2060                             | 2200                      | 815    | 865      | 915       |
| 401 QUEEN HEADBOARD  | 69X11X47  | 1255    | 1360                  | 1465   | 1570   | 1675                             | 1780                      | 655    | 685      | 715       |
| 402 DOUBLE HEADBOARD | 64X11X47  | 1205    | 1305                  | 1405   | 1505   | 1605                             | 1705                      | 590    | 615      | 640       |
| 403 SINGLE HEADBOARD | 49X11X47  | 1050    | 1150                  | 1250   | 1350   | 1450                             | 1550                      | 395    | 415      | 435       |

# LINE

Tête de lit avec oreilles | Headboard with wings

400 King - 401 Queen - 402 Double - 403 Simple | Single

Pour les dimensions des bases; Voir la liste de prix 99905  
For the dimensions of the bed bases; See Price list 99905



Option de clous | Nail options



Silver - Copper - Pewter - Brass  
1/2" diamètre

## 4" Base contour LARGE | WIDE contour Base

### DIMENSIONS

Lit grandeur complète  
Complete bed size

Base: 12" Haut | Height

L x P/D x H

|   |                 |
|---|-----------------|
| K | 87" x 90" x 47" |
| Q | 69" x 90" x 47" |
| D | 64" x 86" x 47" |
| S | 49" x 86" x 47" |



\* Avec pattes | \*With Legs  
K 410 - Q 411 - D 412 - S 413

2 positions de matelas à 9,75" ou 6,5" du plancher  
2 mattress position from 9,75" or 6,5" from the floor



Anti-poussière | No Dust  
K 420 - Q 421 - D 422 - S 423

2 positions de matelas à 9,75" ou 6,5" du plancher  
2 mattress position from 9,75" or 6,5" from the floor

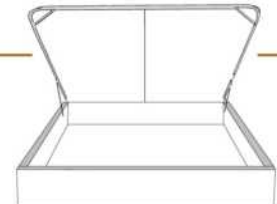

Avec rangement | With Storage  
K 430 - Q 431

1 position de matelas à 10,25" du plancher  
1 mattress position at 10,25" from the floor



Rangement à tiroir frontal  
With Front Drawer  
K 440 - Q 441 - D 442

1 position de matelas à 10,25" du plancher  
1 mattress position at 10,25" from floor



Rangement à tiroir latéraux  
With Side Drawers  
K 450 - Q 451 (2 tiroirs | drawers)  
D 452 - S 453 (1 tiroir | drawer)

1 position de matelas à 10,25" du plancher  
1 mattress position at 10,25" from floor

## 2" Base contour MINCE | NARROW contour Base

### DIMENSIONS

Lit grandeur complète  
Complete bed size

Base: 12" Haut | Height

L x P/D x H

|   |                 |
|---|-----------------|
| K | 87" x 88" x 47" |
| Q | 69" x 88" x 47" |
| D | 64" x 84" x 47" |
| S | 49" x 84" x 47" |



\* Avec pattes | \*With Legs  
K 510 - Q 511 - D 512 - S 513

1 position de matelas à 10,25" du plancher  
1 mattress position at 10,25" from floor



Anti-poussière | No Dust  
K 520 - Q 521 - D 522 - S 523

1 position de matelas à 10,25" du plancher  
1 mattress position at 10,25" from floor

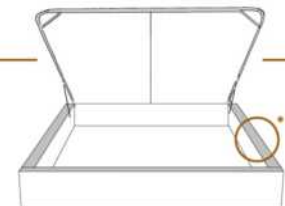

Avec rangement | With Storage  
\*\*1" plus large | \*\*1" wider  
K 530 - Q 531

1 position de matelas à 10,25" du plancher  
1 mattress position at 10,25" from floor



Lit réglable | Adjustable bed  
Pattes de bois seulement | Wood leg only  
K 560 - Q 561 - S 563

|      |          |          |               |
|------|----------|----------|---------------|
|      | King     | Queen    | Simple Single |
| EXT: | 87x87x47 | 69x87x47 | 49x87x47      |
| INT: | 78x82x12 | 61x82x12 | 40x82x12      |



Rangement à tiroir frontal  
With Front Drawer  
K 540 - Q 541 - D 542

1 position de matelas à 10,25" du plancher  
1 mattress position at 10,25" from floor



Rangement à tiroir latéraux  
With Side Drawers  
K 550 - Q 551 (2 tiroirs | drawers)  
D 552 - S 553 (1 tiroir | drawer)

1 position de matelas à 10,25" du plancher  
1 mattress position at 10,25" from floor

Les illustrations sont génériques et n'indiquent pas tous les détails de coutures. | The sketches are generic and do not reflect all sewing details.



Lits rembourrés  
*Upholstered Beds*

## CDN Price List



## LUCIE

GROUP C

Headboard with NO wings - CHOOSE your BED BASE - See 99900 BASE L price list.

Finished BACK of HEADBOARD add:  
- in FABRIC: King \$55, Queen \$50.

| Description         | L x D x H    | Leather |                       |  |  |                                  |                           | Fabric |          |           |
|---------------------|--------------|---------|-----------------------|--|--|----------------------------------|---------------------------|--------|----------|-----------|
|                     |              | 10      | 20<br>Madras<br>Softy | 30<br>Hugo<br>Fantasy<br>Illusion<br>Tucson<br>Utah<br>Vintage<br>Wild Laredo<br>Yukon | 40<br>Elegance<br>Princess<br>Santiago<br>Sensation<br>Sunset<br>Trina<br>Victoria | 50<br>Bull<br>Cassiope<br>Dublin | 60<br>Caress<br>Ultrasued | A      | B<br>COM | C<br>alta |
| 400 KING HEADBOARD  | 96 x 12 x 44 |         |                       |  |  |                                  |                           | 1060   | 1115     | 1170      |
| 401 QUEEN HEADBOARD | 79 x 12 x 44 |         |                       |  |  |                                  |                           | 900    | 950      | 1000      |



# LUCIE

Tête de lit sans oreilles | Headboard without wings

400 King - 401 Queen

Pour les dimensions des bases; Voir la liste de prix 99900  
For the dimensions of the bed bases; See Price list 99900



## 4" Base contour LARGE | WIDE contour Base

### DIMENSIONS

Lit grandeur complète  
Complete bed size

Base: 12" Haut | Height

L x P/D x H

96" x 98" x 44"

79" x 98" x 44"

K  
Q



\*Avec pattes | \*With Legs  
K 410 - Q 411

2 positions de matelas à 9,75" ou 6,5" du plancher  
2 mattress position from 9,75" or 6,5" from the floor



Anti-poussière | No Dust  
K 420 - Q 421

2 positions de matelas à 9,75" ou 6,5" du plancher  
2 mattress position from 9,75" or 6,5" from the floor

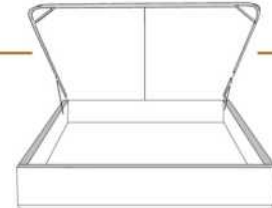

Avec rangement | With Storage  
K 430 - Q 431

1 position de matelas à 10,25" du plancher  
1 mattress position at 10,25" from floor



Rangement à tiroir frontal  
With Front Drawer  
K 440 - Q 441

1 position de matelas à 10,25" du plancher  
1 mattress position at 10,25" from floor



Rangement à tiroir latéraux  
With Side Drawers  
K 450 - Q 451 (2 tiroirs | drawers)

1 position de matelas à 10,25" du plancher  
1 mattress position at 10,25" from floor

## 2" Base contour MINCE | NARROW contour Base

### DIMENSIONS

Lit grandeur complète  
Complete bed size

Base: 12" Haut | Height

L x P/D x H

96" x 96" x 44"

79" x 96" x 44"

K  
Q



\*Avec pattes | \*With Legs  
K 510 - Q 511

1 position de matelas à 10,25" du plancher  
1 mattress position at 10,25" from floor



Anti-poussière | No Dust  
K 520 - Q 521

1 position de matelas à 10,25" du plancher  
1 mattress position at 10,25" from floor

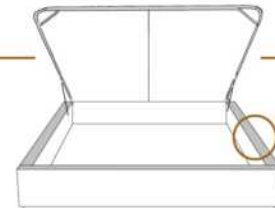

Avec rangement | With Storage  
\*\*1" plus large | \*\*1" wider  
K 530 - Q 531

1 position de matelas à 10,25" du plancher  
1 mattress position at 10,25" from floor



Lit réglable | Adjustable bed  
Pattes de bois seulement | Wood leg only  
K 560 - Q 561

King Queen  
EXT: 96x96x44 79x96x49  
INT: 78x82x12 61x82x12



Rangement à tiroir frontal  
With Front Drawer  
K 540 - Q 541

1 position de matelas à 10,25" du plancher  
1 mattress position at 10,25" from floor



Rangement à tiroir latéraux  
With Side Drawers  
K 550 - Q 551 (2 tiroirs | drawers)

1 position de matelas à 10,25" du plancher  
1 mattress position at 10,25" from floor

Les illustrations sont génériques et n'indiquent pas tous les détails de coutures. | The sketches are generic and do not reflect all sewing details.





Lits rembourrés  
*Upholstered Beds*

## CDN Price List



## MARIANNE

### GROUP C

Headboard WITH WINGS - Choose your bed base - See 99905 BASE C price list.

### OPTIONS:

Decorative Nails: MEDIUM ½" nails on front of headboard wing, ADD \$50.  
Specify nail colour on your order: BRASS-SILVER-PEWTER or COPPER.

Finished BACK of HEADBOARD add:

- in FABRIC: King \$55, Queen \$50, Double \$45, Single \$35.

| Description          | L x D x H | Leather |                       |  |  |                                  |                           | Fabric |          |           |
|----------------------|-----------|---------|-----------------------|--|--|----------------------------------|---------------------------|--------|----------|-----------|
|                      |           | 10      | 20<br>Madras<br>Softy | 30<br>Hugo<br>Fantasy<br>Illusion<br>Tucson<br>Utah<br>Vintage<br>Wild Laredo<br>Yukon | 40<br>Elegance<br>Princess<br>Santiago<br>Sensation<br>Sunset<br>Trina<br>Victoria | 50<br>Bull<br>Cassiope<br>Dublin | 60<br>Caress<br>Ultrasued | A      | B<br>COM | C<br>alta |
| 400 KING HEADBOARD   | 87x11x56  |         |                       |  |  |                                  |                           | 1060   | 1115     | 1170      |
| 401 QUEEN HEADBOARD  | 69x11x56  |         |                       |  |  |                                  |                           | 900    | 950      | 1000      |
| 402 DOUBLE HEADBOARD | 64x11x56  |         |                       |  |  |                                  |                           | 825    | 870      | 915       |
| 403 SINGLE HEADBOARD | 49x11x56  |         |                       |  |  |                                  |                           | 655    | 685      | 715       |

# MARIANNE

Tête de lit avec oreilles | Headboard with wings

400 King - 401 Queen - 402 Double - 403 Simple | Single

Pour les dimensions des bases; Voir la liste de prix 99905  
For the dimensions of the bed bases; See Price list 99905

Option de clous | Nail options



Silver - Copper - Pewter - Brass  
1/2" diamètre



## 4" Base contour LARGE | WIDE contour Base

### DIMENSIONS

Lit grandeur complète  
Complete bed size

Base: 12" Haut | Height

L x P/D x H

K  
Q  
D  
S

87" x 90" x 56"  
69" x 90" x 56"  
64" x 86" x 56"  
49" x 86" x 56"



\*Avec pattes | \*With Legs  
K 410 - Q 411 - D 412 - S 413

2 positions de matelas à 9,75" ou 6,5" du plancher  
2 mattress position from 9,75" or 6,5" from the floor



Anti-poussière | No Dust  
K 420 - Q 421 - D 422 - S 423

2 positions de matelas à 9,75" ou 6,5" du plancher  
2 mattress position from 9,75" or 6,5" from the floor

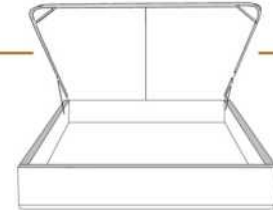

Avec rangement | With Storage  
K 430 - Q 431

1 position de matelas à 10,25" du plancher  
1 mattress position at 10,25" from floor



Rangement à tiroir frontal  
With Front Drawer  
K 440 - Q 441 - D 442

1 position de matelas à 10,25" du plancher  
1 mattress position at 10,25" from floor



Rangement à tiroir latéraux  
With Side Drawers  
K 450 - Q 451 (2 tiroirs | drawers)  
D 452 - S 453 (1 tiroir | drawer)

1 position de matelas à 10,25" du plancher  
1 mattress position at 10,25" from floor

## 2" Base contour MINCE | NARROW contour Base

### DIMENSIONS

Lit grandeur complète  
Complete bed size

Base: 12" Haut | Height

L x P/D x H

K  
Q  
D  
S

87" x 88" x 56"  
69" x 88" x 56"  
64" x 84" x 56"  
49" x 84" x 56"



\*Avec pattes | \*With Legs  
K 510 - Q 511 - D 512 - S 513

1 position de matelas à 10,25" du plancher  
1 mattress position at 10,25" from floor



Anti-poussière | No Dust  
K 520 - Q 521 - D 522 - S 523

1 position de matelas à 10,25" du plancher  
1 mattress position at 10,25" from floor

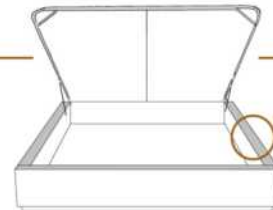

Avec rangement | With Storage  
\*\*1" plus large | \*\*1" wider  
K 530 - Q 531

1 position de matelas à 10,25" du plancher  
1 mattress position at 10,25" from floor



Lit réglable | Adjustable bed  
Pattes de bois seulement | Wood leg only  
K 560 - Q 561 - S 563

|      | King     | Queen    | Simple Single |
|------|----------|----------|---------------|
| EXT: | 87x87x56 | 69x87x56 | 49x87x56      |
| INT: | 78x82x12 | 61x82x12 | 40x82x12      |



Rangement à tiroir frontal  
With Front Drawer  
K 540 - Q 541 - D 542

1 position de matelas à 10,25" du plancher  
1 mattress position at 10,25" from floor



Rangement à tiroir latéraux  
With Side Drawers  
K 550 - Q 551 (2 tiroirs | drawers)  
D 552 - S 553 (1 tiroir | drawer)

1 position de matelas à 10,25" du plancher  
1 mattress position at 10,25" from floor

Les illustrations sont génériques et n'indiquent pas tous les détails de coutures. | The sketches are generic and do not reflect all sewing details.



Lits rembourrés  
*Upholstered Beds*

## CDN Price List



## MARILOU

### GROUP C

Headboard WITH WINGS. Choose your bed base - see 99905 BASE C price list.

### OPTIONS:

Decorative Nails: Large 7/8" nails on OUTER wing contour of headboard . ADD \$45.  
Specify nail colour on your order: BRASS-SILVER-PEWTER or COPPER.

Finished BACK of HEADBOARD add:

In FABRIC: King \$55, Queen \$50, Double \$45, Single \$35.

| Description          | L x D x H    | Leather |                       |  |  |                                  |                           | Fabric |          |           |
|----------------------|--------------|---------|-----------------------|--|--|----------------------------------|---------------------------|--------|----------|-----------|
|                      |              | 10      | 20<br>Madras<br>Softy | 30<br>Hugo<br>Fantasy<br>Illusion<br>Tucson<br>Utah<br>Vintage<br>Wild Laredo<br>Yukon | 40<br>Elegance<br>Princess<br>Santiago<br>Sensation<br>Sunset<br>Trina<br>Victoria | 50<br>Bull<br>Cassiope<br>Dublin | 60<br>Caress<br>Ultrasued | A      | B<br>COM | C<br>alta |
| 400 KING HEADBOARD   | 87 x 11 x 58 |         |                       |  |  |                                  |                           | 1060   | 1115     | 1170      |
| 401 QUEEN HEADBOARD  | 69 x 11 x 58 |         |                       |  |  |                                  |                           | 900    | 950      | 1000      |
| 402 DOUBLE HEADBOARD | 64 x 11 x 58 |         |                       |  |  |                                  |                           | 825    | 870      | 915       |
| 403 SINGLE HEADBOARD | 49 x 11 x 58 |         |                       |  |  |                                  |                           | 655    | 685      | 715       |

# MARILOU

Tête de lit avec oreilles | Headboard with wings

400 King - 401 Queen - 402 Double - 403 Simple | Single

Pour les dimensions des bases; Voir la liste de prix 99905  
For the dimensions of the bed bases; See Price list 99905

Option de clous | Nail options



Silver - Copper - Pewter - Brass  
7/8" diamètre



## 4" Base contour LARGE | WIDE contour Base

### DIMENSIONS

Lit grandeur complète  
Complete bed size

Base: 12" Haut | Height

L x P/D x H

K  
Q  
D  
S

87" x 90" x 58"  
69" x 90" x 58"  
64" x 86" x 58"  
49" x 86" x 58"



\* Avec pattes | \* With Legs  
K 410 - Q 411 - D 412 - S 413

2 positions de matelas à 9,75" ou 6,5" du plancher  
2 mattress position from 9,75" or 6,5" from the floor



Anti-poussière | No Dust  
K 420 - Q 421 - D 422 - S 423

2 positions de matelas à 9,75" ou 6,5" du plancher  
2 mattress position from 9,75" or 6,5" from the floor

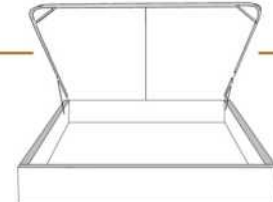

Avec rangement | With Storage  
K 430 - Q 431

1 position de matelas à 10,25" du plancher  
1 mattress position at 10,25" from the floor



Rangement à tiroir frontal  
With Front Drawer  
K 440 - Q 441 - D 442

1 position de matelas à 10,25" du plancher  
1 mattress position at 10,25" from floor



Rangement à tiroir latéraux  
With Side Drawers  
K 450 - Q 451 (2 tiroirs | drawers)  
D 452 - S 453 (1 tiroir | drawer)

1 position de matelas à 10,25" du plancher  
1 mattress position at 10,25" from floor

## 2" Base contour MINCE | NARROW contour Base

### DIMENSIONS

Lit grandeur complète  
Complete bed size

Base: 12" Haut | Height

L x P/D x H

K  
Q  
D  
S

87" x 88" x 58"  
69" x 88" x 58"  
64" x 84" x 58"  
49" x 84" x 58"



\* Avec pattes | \* With Legs  
K 510 - Q 511 - D 512 - S 513

1 position de matelas à 10,25" du plancher  
1 mattress position at 10,25" from floor



Anti-poussière | No Dust  
K 520 - Q 521 - D 522 - S 523

1 position de matelas à 10,25" du plancher  
1 mattress position at 10,25" from floor

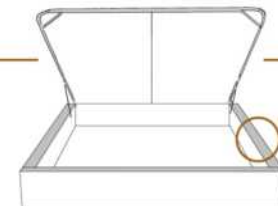

Avec rangement | With Storage  
\*\*1" plus large | \*\*1" wider  
K 530 - Q 531

1 position de matelas à 10,25" du plancher  
1 mattress position at 10,25" from floor



Lit réglable | Adjustable bed  
Pattes de bois seulement | Wood leg only  
K 560 - Q 561 - S 563

|      | King     | Queen    | Simple Single |
|------|----------|----------|---------------|
| EXT: | 87x87x58 | 69x87x58 | 49x87x58      |
| INT: | 78x82x12 | 61x82x12 | 40x82x12      |



Rangement à tiroir frontal  
With Front Drawer  
K 540 - Q 541 - D 542

1 position de matelas à 10,25" du plancher  
1 mattress position at 10,25" from floor



Rangement à tiroir latéraux  
With Side Drawers  
K 550 - Q 551 (2 tiroirs | drawers)  
D 552 - S 553 (1 tiroir | drawer)

1 position de matelas à 10,25" du plancher  
1 mattress position at 10,25" from floor

Les illustrations sont génériques et n'indiquent pas tous les détails de coutures. | The sketches are generic and do not reflect all sewing details.



Lits rembourrés  
*Upholstered Beds*

## CDN Price List



## MAXIM

### GROUP A

Headboard with NO wings - Choose your bed base - See 99900 BASE L price list.

### OPTIONS:

Finished BACK of HEADBOARD add:

- in FABRIC: King \$55, Queen \$50, Double \$45, Single \$35.

| Description          | L x D x H | Leather |                       |  |  |                                  |                           | Fabric |          |           |
|----------------------|-----------|---------|-----------------------|--|--|----------------------------------|---------------------------|--------|----------|-----------|
|                      |           | 10      | 20<br>Madras<br>Softy | 30<br>Hugo<br>Fantasy<br>Illusion<br>Tucson<br>Utah<br>Vintage<br>Wild Laredo<br>Yukon | 40<br>Elegance<br>Princess<br>Santiago<br>Sensation<br>Sunset<br>Trina<br>Victoria | 50<br>Bull<br>Cassiope<br>Dublin | 60<br>Caress<br>Ultrasued | A      | B<br>COM | C<br>alta |
| 400 KING HEADBOARD   | 87x4x46   |         |                       |  |  |                                  |                           | 565    | 615      | 665       |
| 401 QUEEN HEADBOARD  | 69x4x46   |         |                       |  |  |                                  |                           | 480    | 510      | 540       |
| 402 DOUBLE HEADBOARD | 64x4x46   |         |                       |  |  |                                  |                           | 460    | 485      | 510       |
| 403 SINGLE HEADBOARD | 49x4x46   |         |                       |  |  |                                  |                           | 365    | 385      | 405       |



# MAXIM

Tête de lit sans oreilles | Headboard without wings

400 King - 401 Queen - 402 Double - 403 Simple | Single

Pour les dimensions des bases; Voir la liste de prix 99900  
For the dimensions of the bed bases; See Price list 99900



## 4" Base contour LARGE | WIDE contour Base

### DIMENSIONS

Lit grandeur complète  
Complete bed size

Base: 12" Haut | Height

L x P/D x H

K  
Q  
D  
S

87" x 90" x 46"  
69" x 90" x 46"  
64" x 86" x 46"  
49" x 86" x 46"



\*Avec pattes | \*With Legs  
K 410 - Q 411 - D 412 - S 413

2 positions de matelas à 9,75" ou 6,5" du plancher  
2 mattress position from 9,75" or 6,5" from the floor



Anti-poussière | No Dust  
K 420 - Q 421 - D 422 - S 423

2 positions de matelas à 9,75" ou 6,5" du plancher  
2 mattress position from 9,75" or 6,5" from the floor

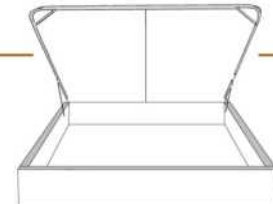

Avec rangement | With Storage  
K 430 - Q 431

1 position de matelas à 10,25" du plancher  
1 mattress position at 10,25" from floor



Rangement à tiroir frontal  
With Front Drawer  
K 440 - Q 441 - D 442

1 position de matelas à 10,25" du plancher  
1 mattress position at 10,25" from floor



Rangement à tiroir latéraux  
With Side Drawers  
K 450 - Q 451 (2 tiroirs | drawers)  
D 452 - S 453 (1 tiroir | drawer)

1 position de matelas à 10,25" du plancher  
1 mattress position at 10,25" from floor

## 2" Base contour MINCE | NARROW contour Base

### DIMENSIONS

Lit grandeur complète  
Complete bed size

Base: 12" Haut | Height

L x P/D x H

K  
Q  
D  
S

87" x 88" x 46"  
69" x 88" x 46"  
64" x 84" x 46"  
49" x 84" x 46"



\*Avec pattes | \*With Legs  
K 510 - Q 511 - D 512 - S 513

1 position de matelas à 10,25" du plancher  
1 mattress position at 10,25" from floor



Anti-poussière | No Dust  
K 520 - Q 521 - D 522 - S 523

1 position de matelas à 10,25" du plancher  
1 mattress position at 10,25" from floor



Avec rangement | With Storage  
\*\*1" plus large | \*\*1" wider  
K 530 - Q 531

1 position de matelas à 10,25" du plancher  
1 mattress position at 10,25" from floor



Lit réglable | Adjustable bed  
Pattes de bois seulement | Wood leg only  
K 560 - Q 561 - S 563

|      | King     | Queen    | Simple Single |
|------|----------|----------|---------------|
| EXT: | 87x88x46 | 69x88x46 | 49x88x46      |
| INT: | 78x82x12 | 61x82x12 | 40x82x12      |



Rangement à tiroir frontal  
With Front Drawer  
K 540 - Q 541 - D 542

1 position de matelas à 10,25" du plancher  
1 mattress position at 10,25" from floor



Rangement à tiroir latéraux  
With Side Drawers  
K 550 - Q 551 (2 tiroirs | drawers)  
D 552 - S 553 (1 tiroir | drawer)

1 position de matelas à 10,25" du plancher  
1 mattress position at 10,25" from floor

Les illustrations sont génériques et n'indiquent pas tous les détails de coutures. | The sketches are generic and do not reflect all sewing details.



Lits rembourrés  
*Upholstered Beds*

## CDN Price List



## MELANIE

### GROUP C

Headboard WITH WINGS. Choose your bed base - see 99905 BASE C price list.

### OPTIONS:

Decorative Nails: Large 7/8" nails on OUTER wing contour of headboard . ADD \$40.  
Specify nail colour on your order: BRASS-SILVER-PEWTER or COPPER.

Finished BACK of HEADBOARD add:

In FABRIC: King \$55, Queen \$50, Double \$45, Single \$35.

| Description          | L x D x H | Leather |                       |  |  |                                  |                           | Fabric |          |           |
|----------------------|-----------|---------|-----------------------|--|--|----------------------------------|---------------------------|--------|----------|-----------|
|                      |           | 10      | 20<br>Madras<br>Softy | 30<br>Hugo<br>Fantasy<br>Illusion<br>Tucson<br>Utah<br>Vintage<br>Wild Laredo<br>Yukon | 40<br>Elegance<br>Princess<br>Santiago<br>Sensation<br>Sunset<br>Trina<br>Victoria | 50<br>Bull<br>Cassiope<br>Dublin | 60<br>Caress<br>Ultrasued | A      | B<br>COM | C<br>alta |
| 400 KING HEADBOARD   | 87X11X56  |         |                       |  |  |                                  |                           | 1060   | 1115     | 1170      |
| 401 QUEEN HEADBOARD  | 69X11X56  |         |                       |  |  |                                  |                           | 900    | 950      | 1000      |
| 402 DOUBLE HEADBOARD | 64X11X56  |         |                       |  |  |                                  |                           | 825    | 870      | 915       |
| 403 SINGLE HEADBOARD | 49X11X56  |         |                       |  |  |                                  |                           | 655    | 685      | 715       |

# MELANIE

Tête de lit avec oreilles | Headboard with wings

400 King - 401 Queen - 402 Double - 403 Simple | Single

Pour les dimensions des bases; Voir la liste de prix 99905  
For the dimensions of the bed bases; See Price list 99905

Option de clous | Nail options



Silver - Copper - Pewter - Brass  
7/8" diamètre



## 4" Base contour LARGE | WIDE contour Base

### DIMENSIONS

Lit grandeur complète  
Complete bed size

Base: 12" Haut | Height

L x P/D x H

K  
Q  
D  
S

87" x 90" x 56"  
69" x 90" x 56"  
64" x 86" x 56"  
49" x 86" x 56"



\* Avec pattes | \*With Legs  
K 410 - Q 411 - D 412 - S 413

2 positions de matelas à 9,75" ou 6,5" du plancher  
2 mattress position from 9,75" or 6,5" from the floor



Anti-poussière | No Dust  
K 420 - Q 421 - D 422 - S 423

2 positions de matelas à 9,75" ou 6,5" du plancher  
2 mattress position from 9,75" or 6,5" from the floor

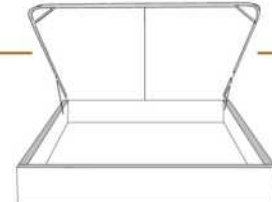

Avec rangement | With Storage  
K 430 - Q 431

1 position de matelas à 10,25" du plancher  
1 mattress position at 10,25" from floor



Rangement à tiroir frontal  
With Front Drawer  
K 440 - Q 441 - D 442

1 position de matelas à 10,25" du plancher  
1 mattress position at 10,25" from floor



Rangement à tiroir latéraux  
With Side Drawers  
K 450 - Q 451 (2 tiroirs | drawers)  
D 452 - S 453 (1 tiroir | drawer)

1 position de matelas à 10,25" du plancher  
1 mattress position at 10,25" from floor

## 2" Base contour MINCE | NARROW contour Base

### DIMENSIONS

Lit grandeur complète  
Complete bed size

Base: 12" Haut | Height

L x P/D x H

K  
Q  
D  
S

87" x 88" x 56"  
69" x 88" x 56"  
64" x 84" x 56"  
49" x 84" x 56"



\* Avec pattes | \*With Legs  
K 510 - Q 511 - D 512 - S 513

1 position de matelas à 10,25" du plancher  
1 mattress position at 10,25" from floor



Anti-poussière | No Dust  
K 520 - Q 521 - D 522 - S 523

1 position de matelas à 10,25" du plancher  
1 mattress position at 10,25" from floor

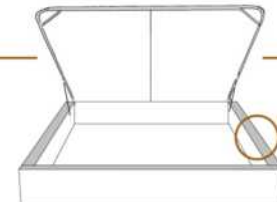

Avec rangement | With Storage  
\*\*1" plus large | \*\*1" wider  
K 530 - Q 531

1 position de matelas à 10,25" du plancher  
1 mattress position at 10,25" from floor



Lit réglable | Adjustable bed  
Pattes de bois seulement | Wood leg only  
K 560 - Q 561 - S 563

|      | King     | Queen    | Simple   Single |
|------|----------|----------|-----------------|
| EXT: | 87x87x56 | 69x87x56 | 49x87x56        |
| INT: | 78x82x12 | 61x82x12 | 40x82x12        |

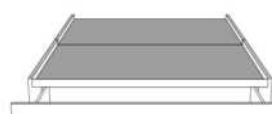

Rangement à tiroir frontal  
With Front Drawer  
K 540 - Q 541 - D 542

1 position de matelas à 10,25" du plancher  
1 mattress position at 10,25" from floor



Rangement à tiroir latéraux  
With Side Drawers  
K 550 - Q 551 (2 tiroirs | drawers)  
D 552 - S 553 (1 tiroir | drawer)

1 position de matelas à 10,25" du plancher  
1 mattress position at 10,25" from floor

Les illustrations sont génériques et n'indiquent pas tous les détails de coutures. | The sketches are generic and do not reflect all sewing details.





Lits rembourrés  
*Upholstered Beds*

## CDN Price List



## MELISSA

### GROUP C

Headboard with NO wings - CHOOSE your BED BASE - See 99900 BASE L price list.

Finished BACK of HEADBOARD add:

- in LEATHER: King \$175, Queen \$145, Double \$135, Single \$105.

- in FABRIC: King \$55, Queen \$50, Double \$45, Single \$35.

| Description         | L x D x H   | Leather |                       |  |  |                                  |                           | Fabric |          |           |
|---------------------|-------------|---------|-----------------------|--|--|----------------------------------|---------------------------|--------|----------|-----------|
|                     |             | 10      | 20<br>Madras<br>Softy | 30<br>Hugo<br>Fantasy<br>Illusion<br>Tucson<br>Utah<br>Vintage<br>Wild Laredo<br>Yukon | 40<br>Elegance<br>Princess<br>Santiago<br>Sensation<br>Sunset<br>Trina<br>Victoria | 50<br>Bull<br>Cassiope<br>Dublin | 60<br>Caress<br>Ultrasued | A      | B<br>COM | C<br>alta |
| 400 KING HEADBOARD  | 88 x 9 x 46 | 1650    | 1785                  | 1920   | 2055   | 2190                             | 2325                      | 1060   | 1115     | 1170      |
| 401 QUEEN HEADBOARD | 74 x 9 x 46 | 1300    | 1405                  | 1510   | 1615   | 1720                             | 1825                      | 900    | 950      | 1000      |

# MELISSA

Tête de lit sans oreilles | Headboard without wings

400 King - 401 Queen

Pour les dimensions des bases; Voir la liste de prix 99900  
For the dimensions of the bed bases; See Price list 99900



## 4" Base contour LARGE | WIDE contour Base

### DIMENSIONS

Lit grandeur complète  
Complete bed size

Base: 12" Haut | Height

L x P/D x H

88" x 95" x 46"

74" x 95" x 46"

K  
Q



\*Avec pattes | \*With Legs  
K 410 - Q 411

2 positions de matelas à 9,75" ou 6,5" du plancher  
2 mattress position from 9,75" or 6,5" from the floor



Anti-poussière | No Dust  
K 420 - Q 421

2 positions de matelas à 9,75" ou 6,5" du plancher  
2 mattress position from 9,75" or 6,5" from the floor

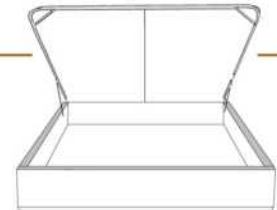

Avec rangement | With Storage  
K 430 - Q 431

1 position de matelas à 10,25" du plancher  
1 mattress position at 10,25" from floor



Rangement à tiroir frontal  
With Front Drawer  
K 440 - Q 441

1 position de matelas à 10,25" du plancher  
1 mattress position at 10,25" from floor



Rangement à tiroir latéraux  
With Side Drawers  
K 450 - Q 451 (2 tiroirs | drawers)

1 position de matelas à 10,25" du plancher  
1 mattress position at 10,25" from floor

## 2" Base contour MINCE | NARROW contour Base

### DIMENSIONS

Lit grandeur complète  
Complete bed size

Base: 12" Haut | Height

L x P/D x H

88" x 93" x 46"

74" x 93" x 46"

K  
Q



\*Avec pattes | \*With Legs  
K 510 - Q 511

1 position de matelas à 10,25" du plancher  
1 mattress position at 10,25" from floor



Anti-poussière | No Dust  
K 520 - Q 521

1 position de matelas à 10,25" du plancher  
1 mattress position at 10,25" from floor

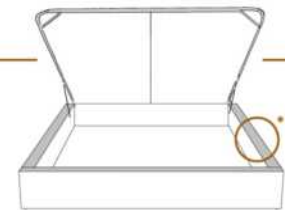

Avec rangement | With Storage  
\*\*1" plus large | \*\*1" wider  
K 530 - Q 531

1 position de matelas à 10,25" du plancher  
1 mattress position at 10,25" from floor



Lit réglable | Adjustable bed  
Pattes de bois seulement | Wood leg only  
K 560 - Q 561

King Queen  
EXT: 87x102x46 69x102x46  
INT: 78x82x12 61x82x12



Rangement à tiroir frontal  
With Front Drawer  
K 540 - Q 541

1 position de matelas à 10,25" du plancher  
1 mattress position at 10,25" from floor



Rangement à tiroir latéraux  
With Side Drawers  
K 550 - Q 551 (2 tiroirs | drawers)

1 position de matelas à 10,25" du plancher  
1 mattress position at 10,25" from floor

Les illustrations sont génériques et n'indiquent pas tous les détails de coutures. | The sketches are generic and do not reflect all sewing details.



## MELODY

LEGS: Metal LG64; Wood: LG68 IMPORTANT specify colour of wooden legs.

ITEMS: 380, 360, 304 & 314 include 3 wood slats with central legs preinstalled at high position 9 3/4" overall height. Adjustable to a lower position (6 1/2" overall height) includes three 6 1/2" central legs. POSTURE BOARD included.

OPTION: Finished BACK of HEADBOARD add:

- in LEATHER: King \$175, Queen \$145, Double \$135, Single \$105.

- in FABRIC: King \$55, Queen \$50, Double \$45, Single \$35.

| Description    | L x D x H  | Leather |                       |  |  |                                  |                           | Fabric |          |           |
|----------------|------------|---------|-----------------------|--|--|----------------------------------|---------------------------|--------|----------|-----------|
|                |            | 10      | 20<br>Madras<br>Softy | 30<br>Hugo<br>Fantasy<br>Illusion<br>Tucson<br>Utah<br>Vintage<br>Wild Laredo<br>Yukon | 40<br>Elegance<br>Princess<br>Santiago<br>Sensation<br>Sunset<br>Trina<br>Victoria | 50<br>Bull<br>Cassiope<br>Dublin | 60<br>Caress<br>Ultrasued | A      | B<br>COM | C<br>alta |
| 304 DOUBLE BED | 72X93X32/9 | 1670    | 1845                  | 2020   | 2195   | 2370                             | 2545                      | 1155   | 1230     | 1305      |
| 314 SINGLE BED | 57X93X32/9 | 1500    | 1655                  | 1810   | 1965   | 2120                             | 2275                      | 1050   | 1135     | 1220      |
| 360 QUEEN BED  | 78X97X32/9 | 1735    | 1905                  | 2075   | 2245   | 2415                             | 2585                      | 1230   | 1305     | 1380      |
| 380 KING BED   | 94X97X32/9 | 1970    | 2165                  | 2360   | 2555   | 2750                             | 2945                      | 1385   | 1490     | 1595      |

# MELODY

items

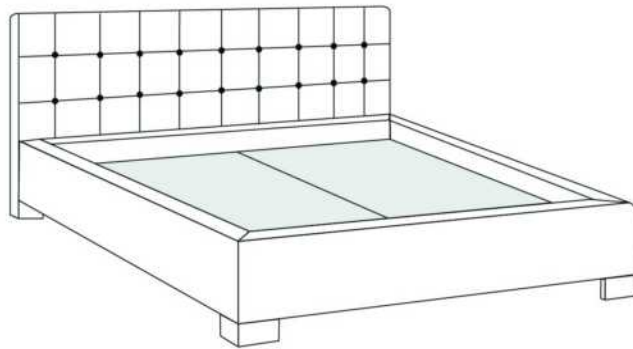

Lit/Bed

380 King | 360 Queen | 304 Double | 314 Simple/ Single

Les illustrations sont génériques et n'indiquent pas tous les détails de coutures.  
The sketches are generic and do not reflect all sewing details.

R2014-03



Lits rembourrés  
*Upholstered Beds*

## CDN Price List



## MILAN

### GROUP C

Headboard with NO wings - CHOOSE your BED BASE - See 99900 BASE L price list.

FEATURE: Adjustable headrest .

Finished BACK of HEADBOARD add:

- in LEATHER: King \$175, Queen \$145, Double \$135, Single \$105.

- in FABRIC: King \$55, Queen \$50, Double \$45, Single \$35.

| Description          | L x D x H     | Leather |                       |  |  |                                  |                           | Fabric |          |           |
|----------------------|---------------|---------|-----------------------|--|--|----------------------------------|---------------------------|--------|----------|-----------|
|                      |               | 10      | 20<br>Madras<br>Softy | 30<br>Hugo<br>Fantasy<br>Illusion<br>Tucson<br>Utah<br>Vintage<br>Wild Laredo<br>Yukon | 40<br>Elegance<br>Princess<br>Santiago<br>Sensation<br>Sunset<br>Trina<br>Victoria | 50<br>Bull<br>Cassiope<br>Dublin | 60<br>Caress<br>Ultrasued | A      | B<br>COM | C<br>alta |
| 400 KING HEADBOARD   | 87X17.5X45/38 | 1650    | 1785                  | 1920   | 2055   | 2190                             | 2325                      | 1060   | 1115     | 1170      |
| 401 QUEEN HEADBOARD  | 69X17.5X45/38 | 1300    | 1405                  | 1510   | 1615   | 1720                             | 1825                      | 900    | 950      | 1000      |
| 402 DOUBLE HEADBOARD | 64X17.5X45/38 | 1245    | 1345                  | 1445   | 1545   | 1645                             | 1745                      | 825    | 870      | 915       |
| 403 SINGLE HEADBOARD | 49X17.5X45/38 | 960     | 1040                  | 1120   | 1200   | 1280                             | 1360                      | 655    | 685      | 715       |

# MILAN



Tête de lit sans oreilles | Headboard without wings

400 King - 401 Queen - 402 Double - 403 Simple | Single

Pour les dimensions des bases; Voir la liste de prix 99900  
For the dimensions of the bed bases; See Price list 99900



## 4" Base contour LARGE | WIDE contour Base

### DIMENSIONS

Lit grandeur complète  
Complete bed size

Base: 12" Haut | Height

L x P/D x H

K 87" x 103,5" x 45/38"  
Q 69" x 103,5" x 45/38"  
D 64" x 99,5" x 45/38"  
S 49" x 99,5" x 45/38"



\* Avec pattes | \* With Legs  
K 410 - Q 411 - D 412 - S 413

2 positions de matelas à 9,75" ou 6,5" du plancher  
2 mattress position from 9,75" or 6,5" from the floor



Anti-poussière | No Dust  
K 420 - Q 421 - D 422 - S 423

2 positions de matelas à 9,75" ou 6,5" du plancher  
2 mattress position from 9,75" or 6,5" from the floor

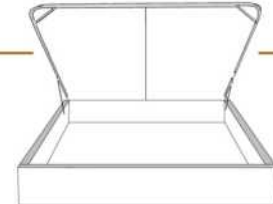

Avec rangement | With Storage  
K 430 - Q 431

1 position de matelas à 10,25" du plancher  
1 mattress position at 10,25" from floor



Rangement à tiroir frontal  
With Front Drawer

K 440 - Q 441 - D 442

1 position de matelas à 10,25" du plancher  
1 mattress position at 10,25" from floor



Rangement à tiroir latéraux  
With Side Drawers  
K 450 - Q 451 (2 tiroirs | drawers)  
D 452 - S 453 (1 tiroir | drawer)

1 position de matelas à 10,25" du plancher  
1 mattress position at 10,25" from floor

## 2" Base contour MINCE | NARROW contour Base

### DIMENSIONS

Lit grandeur complète  
Complete bed size

Base: 12" Haut | Height

L x P/D x H

K 87" x 101,5" x 45/38"  
Q 69" x 101,5" x 45/38"  
D 64" x 97,5" x 45/38"  
S 49" x 97,5" x 45/38"



\* Avec pattes | \* With Legs  
K 510 - Q 511 - D 512 - S 513

1 position de matelas à 10,25" du plancher  
1 mattress position at 10,25" from floor



Anti-poussière | No Dust  
K 520 - Q 521 - D 522 - S 523

1 position de matelas à 10,25" du plancher  
1 mattress position at 10,25" from floor

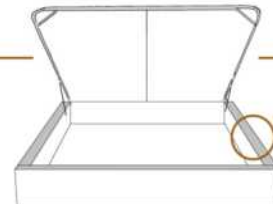

Avec rangement | With Storage  
\*\*1" plus large | \*\*1" wider  
K 530 - Q 531

1 position de matelas à 10,25" du plancher  
1 mattress position at 10,25" from floor

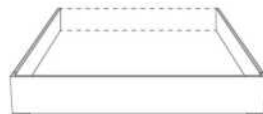

Lit réglable | Adjustable bed  
Pattes de bois seulement | Wood leg only  
K 560 - Q 561 - S 563

King Queen Simple|Single  
EXT: 87x102x45/38 69x102x45/38 49x102x45/38  
INT: 78x82x12 61x82x12 40x82x12



Rangement à tiroir frontal  
With Front Drawer  
K 540 - Q 541 - D 542

1 position de matelas à 10,25" du plancher  
1 mattress position at 10,25" from floor



Rangement à tiroir latéraux  
With Side Drawers  
K 550 - Q 551 (2 tiroirs | drawers)  
D 552 - S 553 (1 tiroir | drawer)

1 position de matelas à 10,25" du plancher  
1 mattress position at 10,25" from floor

Les illustrations sont génériques et n'indiquent pas tous les détails de coutures. | The sketches are generic and do not reflect all sewing details.



## MODENA

GROUP A

Headboard with NO wings - CHOOSE your BED BASE - See 99900 BASE L price list.

Finished BACK of HEADBOARD add:

- in LEATHER: King \$175, Queen \$145, Double \$135, Single \$105.

- in FABRIC: King \$55, Queen \$50, Double \$45, Single \$35.

| Description          | L x D x H | Leather |                       |  |  |                                  |                           | Fabric |          |           |
|----------------------|-----------|---------|-----------------------|--|--|----------------------------------|---------------------------|--------|----------|-----------|
|                      |           | 10      | 20<br>Madras<br>Softy | 30<br>Hugo<br>Fantasy<br>Illusion<br>Tucson<br>Utah<br>Vintage<br>Wild Laredo<br>Yukon | 40<br>Elegance<br>Princess<br>Santiago<br>Sensation<br>Sunset<br>Trina<br>Victoria | 50<br>Bull<br>Cassiope<br>Dublin | 60<br>Caress<br>Ultrasued | A      | B<br>COM | C<br>alta |
| 400 KING HEADBOARD   | 87X4X49   | 890     | 1005                  | 1120   | 1235   | 1350                             | 1465                      | 565    | 615      | 665       |
| 401 QUEEN HEADBOARD  | 69X4X49   | 805     | 910                   | 1015   | 1120   | 1225                             | 1330                      | 480    | 510      | 540       |
| 402 DOUBLE HEADBOARD | 64X4X49   | 735     | 835                   | 935  | 1035   | 1135                             | 1235                      | 460    | 485      | 510       |
| 403 SINGLE HEADBOARD | 49X4X49   | 675     | 755                   | 835  | 915  | 995                              | 1075                      | 365    | 385      | 405       |



# MODENA

Tête de lit sans oreilles | Headboard without wings

400 King - 401 Queen - 402 Double - 403 Simple | Single

Pour les dimensions des bases; Voir la liste de prix 99900  
For the dimensions of the bed bases; See Price list 99900

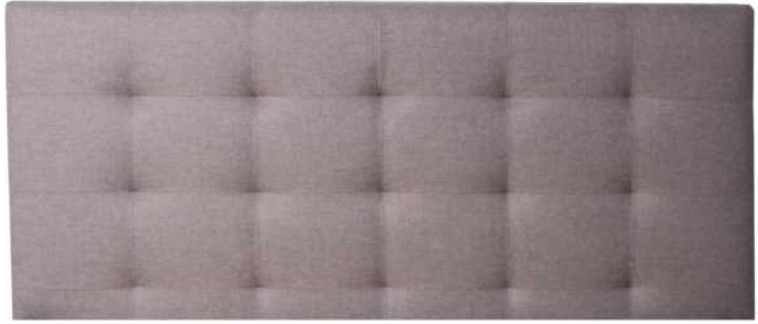

## 4" Base contour LARGE | WIDE contour Base

### DIMENSIONS

Lit grandeur complète  
Complete bed size

Base: 12" Haut | Height

L x P/D x H

K  
Q  
D  
S

87" x 90" x 49"  
69" x 90" x 49"  
64" x 86" x 49"  
49" x 86" x 49"



\*Avec pattes | \*With Legs  
K 410 - Q 411 - D 412 - S 413

2 positions de matelas à 9,75" ou 6,5" du plancher  
2 mattress position from 9,75" or 6,5" from the floor



Anti-poussière | No Dust  
K 420 - Q 421 - D 422 - S 423

2 positions de matelas à 9,75" ou 6,5" du plancher  
2 mattress position from 9,75" or 6,5" from the floor

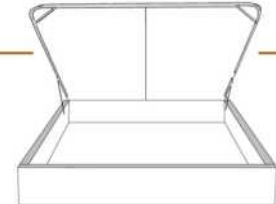

Avec rangement | With Storage  
K 430 - Q 431

1 position de matelas à 10,25" du plancher  
1 mattress position at 10,25" from the floor



Rangement à tiroir frontal  
With Front Drawer  
K 440 - Q 441 - D 442

1 position de matelas à 10,25" du plancher  
1 mattress position at 10,25" from the floor



Rangement à tiroir latéraux  
With Side Drawers  
K 450 - Q 451 (2 tiroirs | drawers)  
D 452 - S 453 (1 tiroir | drawer)

1 position de matelas à 10,25" du plancher  
1 mattress position at 10,25" from the floor

## 2" Base contour MINCE | NARROW contour Base

### DIMENSIONS

Lit grandeur complète  
Complete bed size

Base: 12" Haut | Height

L x P/D x H

K  
Q  
D  
S

87" x 88" x 49"  
69" x 88" x 49"  
64" x 84" x 49"  
49" x 84" x 49"



\*Avec pattes | \*With Legs  
K 510 - Q 511 - D 512 - S 513

1 position de matelas à 10,25" du plancher  
1 mattress position at 10,25" from the floor



Anti-poussière | No Dust  
K 520 - Q 521 - D 522 - S 523

1 position de matelas à 10,25" du plancher  
1 mattress position at 10,25" from the floor

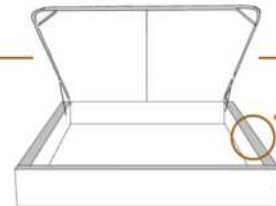

Avec rangement | With Storage  
\*\*1" plus large | \*\*1" wider  
K 530 - Q 531

1 position de matelas à 10,25" du plancher  
1 mattress position at 10,25" from the floor



Lit réglable | Adjustable bed  
Pattes de bois seulement | Wood leg only  
K 560 - Q 561 - S 563

|      | King     | Queen    | Simple Single |
|------|----------|----------|---------------|
| EXT: | 87x88x49 | 69x88x49 | 49x88x49      |
| INT: | 78x82x12 | 61x82x12 | 40x82x12      |



Rangement à tiroir frontal  
With Front Drawer  
K 540 - Q 541 - D 542

1 position de matelas à 10,25" du plancher  
1 mattress position at 10,25" from the floor



Rangement à tiroir latéraux  
With Side Drawers  
K 550 - Q 551 (2 tiroirs | drawers)  
D 552 - S 553 (1 tiroir | drawer)

1 position de matelas à 10,25" du plancher  
1 mattress position at 10,25" from the floor

Les illustrations sont génériques et n'indiquent pas tous les détails de coutures. | The sketches are generic and do not reflect all sewing details.





Lits rembourrés  
*Upholstered Beds*

## CDN Price List



## NATHALIE

### GROUP B

Headboard with NO wings - CHOOSE your BED BASE - See 99900 BASE L price list.

Finished BACK of HEADBOARD add:

- in LEATHER: King \$175, Queen \$145, Double \$135, Single \$105.
- in FABRIC: King \$55, Queen \$50, Double \$45, Single \$35.

| Description          | L x D x H | Leather |                       |  |  |                                  |                           | Fabric |          |           |
|----------------------|-----------|---------|-----------------------|--|--|----------------------------------|---------------------------|--------|----------|-----------|
|                      |           | 10      | 20<br>Madras<br>Softy | 30<br>Hugo<br>Fantasy<br>Illusion<br>Tucson<br>Utah<br>Vintage<br>Wild Laredo<br>Yukon | 40<br>Elegance<br>Princess<br>Santiago<br>Sensation<br>Sunset<br>Trina<br>Victoria | 50<br>Bull<br>Cassiope<br>Dublin | 60<br>Caress<br>Ultrasued | A      | B<br>COM | C<br>alta |
| 400 KING HEADBOARD   | 87X4X72   | 1500    | 1640                  | 1780   | 1920   | 2060                             | 2200                      | 815    | 865      | 915       |
| 401 QUEEN HEADBOARD  | 69X4X72   | 1255    | 1360                  | 1465   | 1570   | 1675                             | 1780                      | 655    | 685      | 715       |
| 402 DOUBLE HEADBOARD | 64X4X72   | 1205    | 1305                  | 1405   | 1505   | 1605                             | 1705                      | 590    | 615      | 640       |
| 403 SINGLE HEADBOARD | 49X4X72   | 1050    | 1150                  | 1250   | 1350   | 1450                             | 1550                      | 395    | 415      | 435       |

# NATHALIE

Tête de lit **sans** oreilles | Headboard **without** wings

400 King - 401 Queen - 402 Double - 403 Simple | Single

Pour les dimensions des bases; Voir la liste de prix 99900  
For the dimensions of the bed bases; See Price list 99900

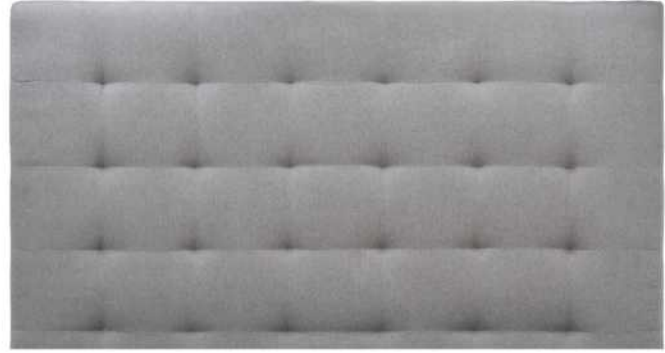

## 4" Base contour LARGE | WIDE contour Base

### DIMENSIONS

Lit grandeur complète  
Complete bed size

Base: 12" Haut | Height

L x P/D x H

K  
Q  
D  
S

87" x 90" x 72"

69" x 90" x 72"

64" x 86" x 72"

49" x 86" x 72"



**\* Avec pattes | \*With Legs**  
**K 410 - Q 411 - D 412 - S 413**

2 positions de matelas à 9,75" ou 6,5" du plancher  
2 mattress position from 9,75" or 6,5" from the floor



**Anti-poussière | No Dust**  
**K 420 - Q 421 - D 422 - S 423**

2 positions de matelas à 9,75" ou 6,5" du plancher  
2 mattress position from 9,75" or 6,5" from the floor

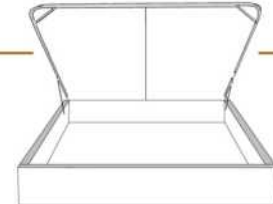

**Avec rangement | With Storage**  
**K 430 - Q 431**

1 position de matelas à 10,25" du plancher  
1 mattress position at 10,25" from the floor



**Rangement à tiroir frontal**  
**With Front Drawer**  
**K 440 - Q 441 - D 442**

1 position de matelas à 10,25" du plancher  
1 mattress position at 10,25" from floor



**Rangement à tiroir latéraux**  
**With Side Drawers**  
**K 450 - Q 451 (2 tiroirs | drawers)**  
**D 452 - S 453 (1 tiroir | drawer)**

1 position de matelas à 10,25" du plancher  
1 mattress position at 10,25" from floor

## 2" Base contour MINCE | NARROW contour Base

### DIMENSIONS

Lit grandeur complète  
Complete bed size

Base: 12" Haut | Height

L x P/D x H

K  
Q  
D  
S

87" x 88" x 72"

69" x 88" x 72"

64" x 84" x 72"

49" x 84" x 72"



**\* Avec pattes | \*With Legs**  
**K 510 - Q 511 - D 512 - S 513**

1 position de matelas à 10,25" du plancher  
1 mattress position at 10,25" from floor



**Anti-poussière | No Dust**  
**K 520 - Q 521 - D 522 - S 523**

1 position de matelas à 10,25" du plancher  
1 mattress position at 10,25" from floor

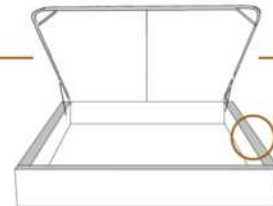

**Avec rangement | With Storage**  
**\*\*1" plus large | \*\*1" wider**  
**K 530 - Q 531**

1 position de matelas à 10,25" du plancher  
1 mattress position at 10,25" from floor



**Lit réglable | Adjustable bed**  
*Pattes de bois seulement | Wood leg only*  
**K 560 - Q 561 - S 563**

|      | King     | Queen    | Simple Single |
|------|----------|----------|---------------|
| EXT: | 87x88x72 | 69x88x72 | 49x88x72      |
| INT: | 78x82x12 | 61x82x12 | 40x82x12      |



**Rangement à tiroir frontal**  
**With Front Drawer**  
**K 540 - Q 541 - D 542**

1 position de matelas à 10,25" du plancher  
1 mattress position at 10,25" from floor



**Rangement à tiroir latéraux**  
**With Side Drawers**  
**K 550 - Q 551 (2 tiroirs | drawers)**  
**D 552 - S 553 (1 tiroir | drawer)**

1 position de matelas à 10,25" du plancher  
1 mattress position at 10,25" from floor

Les illustrations sont génériques et n'indiquent pas tous les détails de coutures. | The sketches are generic and do not reflect all sewing details.



Lits rembourrés  
*Upholstered Beds*

## CDN Price List



### NEIGE 56"H

GROUP C

Headboard WITH WINGS - Choose your bed base - See 99905 BASE C price list.

OPTIONS:

Decorative Nails: MEDIUM ½" nails on front of headboard wing, ADD \$60.

Specify nail colour on your order: BRASS-SILVER-PEWTER or COPPER.

Finished BACK of HEADBOARD add:

In FABRIC: King \$55, Queen \$50, Double \$45, Single \$35.

| Description          | L x D x H | Leather |                       |  |  |                                  |                           | Fabric |          |           |
|----------------------|-----------|---------|-----------------------|--|--|----------------------------------|---------------------------|--------|----------|-----------|
|                      |           | 10      | 20<br>Madras<br>Softy | 30<br>Hugo<br>Fantasy<br>Illusion<br>Tucson<br>Utah<br>Vintage<br>Wild Laredo<br>Yukon | 40<br>Elegance<br>Princess<br>Santiago<br>Sensation<br>Sunset<br>Trina<br>Victoria | 50<br>Bull<br>Cassiope<br>Dublin | 60<br>Caress<br>Ultrasued | A      | B<br>COM | C<br>alta |
| 400 KING HEADBOARD   | 87X11X56  |         |                       |  |  |                                  |                           | 1060   | 1115     | 1170      |
| 401 QUEEN HEADBOARD  | 69X11X56  |         |                       |  |  |                                  |                           | 900    | 950      | 1000      |
| 402 DOUBLE HEADBOARD | 64X11X56  |         |                       |  |  |                                  |                           | 825    | 870      | 915       |
| 403 SINGLE HEADBOARD | 49X11X56  |         |                       |  |  |                                  |                           | 655    | 685      | 715       |

# NEIGE

Tête de lit avec oreilles | Headboard with wings

400 King - 401 Queen - 402 Double - 403 Simple | Single

Pour les dimensions des bases; Voir la liste de prix 99905  
For the dimensions of the bed bases; See Price list 99905

Option de clous | Nail options



Silver - Copper - Pewter - Brass  
1/2" diamètre



## 4" Base contour LARGE | WIDE contour Base

### DIMENSIONS

Lit grandeur complète  
Complete bed size

Base: 12" Haut | Height

L x P/D x H

K  
Q  
D  
S

87" x 90" x 56"  
69" x 90" x 56"  
64" x 86" x 56"  
49" x 86" x 56"



\*Avec pattes | \*With Legs  
K 410 - Q 411 - D 412 - S 413

2 positions de matelas à 9,75" ou 6,5" du plancher  
2 mattress position from 9,75" or 6,5" from the floor



Anti-poussière | No Dust  
K 420 - Q 421 - D 422 - S 423

2 positions de matelas à 9,75" ou 6,5" du plancher  
2 mattress position from 9,75" or 6,5" from the floor

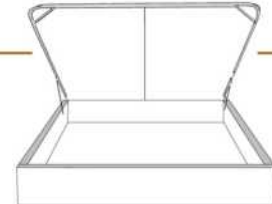

Avec rangement | With Storage  
K 430 - Q 431

1 position de matelas à 10,25" du plancher  
1 mattress position at 10,25" from floor



Rangement à tiroir frontal  
With Front Drawer  
K 440 - Q 441 - D 442

1 position de matelas à 10,25" du plancher  
1 mattress position at 10,25" from floor



Rangement à tiroir latéraux  
With Side Drawers  
K 450 - Q 451 (2 tiroirs | drawers)  
D 452 - S 453 (1 tiroir | drawer)

1 position de matelas à 10,25" du plancher  
1 mattress position at 10,25" from floor

## 2" Base contour MINCE | NARROW contour Base

### DIMENSIONS

Lit grandeur complète  
Complete bed size

Base: 12" Haut | Height

L x P/D x H

K  
Q  
D  
S

87" x 88" x 56"  
69" x 88" x 56"  
64" x 84" x 56"  
49" x 84" x 56"



\*Avec pattes | \*With Legs  
K 510 - Q 511 - D 512 - S 513

1 position de matelas à 10,25" du plancher  
1 mattress position at 10,25" from floor



Anti-poussière | No Dust  
K 520 - Q 521 - D 522 - S 523

1 position de matelas à 10,25" du plancher  
1 mattress position at 10,25" from floor

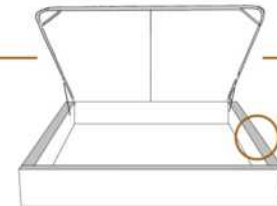

Avec rangement | With Storage  
\*\*1" plus large | \*\*1" wider  
K 530 - Q 531

1 position de matelas à 10,25" du plancher  
1 mattress position at 10,25" from floor



Lit réglable | Adjustable bed  
Pattes de bois seulement | Wood leg only  
K 560 - Q 561 - S 563

|      | King     | Queen    | Simple Single |
|------|----------|----------|---------------|
| EXT: | 87x87x56 | 69x87x56 | 49x87x56      |
| INT: | 78x82x12 | 61x82x12 | 40x82x12      |

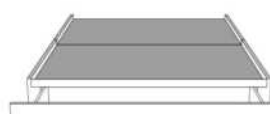

Rangement à tiroir frontal  
With Front Drawer  
K 540 - Q 541 - D 542

1 position de matelas à 10,25" du plancher  
1 mattress position at 10,25" from floor



Rangement à tiroir latéraux  
With Side Drawers  
K 550 - Q 551 (2 tiroirs | drawers)  
D 552 - S 553 (1 tiroir | drawer)

1 position de matelas à 10,25" du plancher  
1 mattress position at 10,25" from floor

Les illustrations sont génériques et n'indiquent pas tous les détails de coutures. | The sketches are generic and do not reflect all sewing details.



Lits rembourrés  
*Upholstered Beds*

## CDN Price List



## RACHEL

### GROUP A

Headboard with NO wings - CHOOSE your BED BASE - See 99900 BASE L price list.

Finished BACK of HEADBOARD add:

- in LEATHER: King \$175, Queen \$145, Double \$135, Single \$105.

- in FABRIC: King \$55, Queen \$50, Double \$45, Single \$35.

| Description          | L x D x H | Leather |                       |  |  |                                  |                           | Fabric |          |           |
|----------------------|-----------|---------|-----------------------|--|--|----------------------------------|---------------------------|--------|----------|-----------|
|                      |           | 10      | 20<br>Madras<br>Softy | 30<br>Hugo<br>Fantasy<br>Illusion<br>Tucson<br>Utah<br>Vintage<br>Wild Laredo<br>Yukon | 40<br>Elegance<br>Princess<br>Santiago<br>Sensation<br>Sunset<br>Trina<br>Victoria | 50<br>Bull<br>Cassiope<br>Dublin | 60<br>Caress<br>Ultrasued | A      | B<br>COM | C<br>alta |
| 400 KING HEADBOARD   | 87X4X49   | 890     | 1005                  | 1120   | 1235   | 1350                             | 1465                      | 565    | 615      | 665       |
| 401 QUEEN HEADBOARD  | 69X4X49   | 805     | 910                   | 1015   | 1120   | 1225                             | 1330                      | 480    | 510      | 540       |
| 402 DOUBLE HEADBOARD | 64X4X49   | 735     | 835                   | 935  | 1035   | 1135                             | 1235                      | 460    | 485      | 510       |
| 403 SINGLE HEADBOARD | 49X4X49   | 675     | 755                   | 835  | 915  | 995                              | 1075                      | 365    | 385      | 405       |



# RACHEL

Tête de lit sans oreilles | Headboard without wings

400 King - 401 Queen - 402 Double - 403 Simple | Single

Pour les dimensions des bases; Voir la liste de prix 99900  
For the dimensions of the bed bases; See Price list 99900

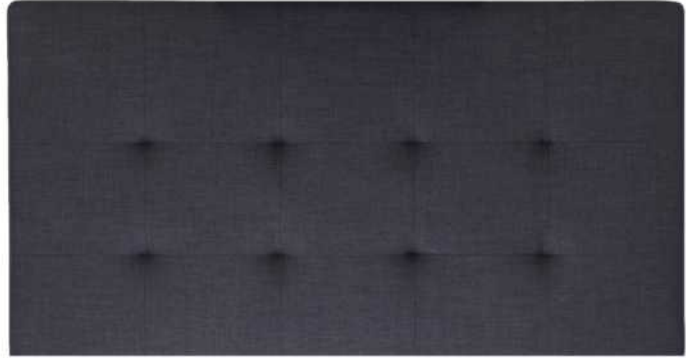

## 4" Base contour LARGE | WIDE contour Base

### DIMENSIONS

Lit grandeur complète  
Complete bed size

Base: 12" Haut | Height

L x P/D x H

K  
Q  
D  
S

87" x 90" x 49"

69" x 90" x 49"

64" x 86" x 49"

49" x 86" x 49"



\* Avec pattes | \*With Legs  
K 410 - Q 411 - D 412 - S 413

2 positions de matelas à 9,75" ou 6,5" du plancher  
2 mattress position from 9,75" or 6,5" from the floor



Anti-poussière | No Dust  
K 420 - Q 421 - D 422 - S 423

2 positions de matelas à 9,75" ou 6,5" du plancher  
2 mattress position from 9,75" or 6,5" from the floor

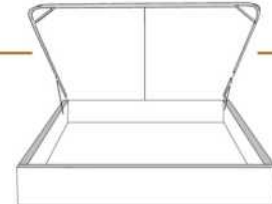

Avec rangement | With Storage  
K 430 - Q 431

1 position de matelas à 10,25" du plancher  
1 mattress position at 10,25" from the floor



Rangement à tiroir frontal  
With Front Drawer  
K 440 - Q 441 - D 442

1 position de matelas à 10,25" du plancher  
1 mattress position at 10,25" from the floor



Rangement à tiroir latéraux  
With Side Drawers  
K 450 - Q 451 (2 tiroirs | drawers)  
D 452 - S 453 (1 tiroir | drawer)

1 position de matelas à 10,25" du plancher  
1 mattress position at 10,25" from the floor

## 2" Base contour MINCE | NARROW contour Base

### DIMENSIONS

Lit grandeur complète  
Complete bed size

Base: 12" Haut | Height

L x P/D x H

K  
Q  
D  
S

87" x 88" x 49"

69" x 88" x 49"

64" x 84" x 49"

49" x 84" x 49"



\* Avec pattes | \*With Legs  
K 510 - Q 511 - D 512 - S 513

1 position de matelas à 10,25" du plancher  
1 mattress position at 10,25" from the floor



Anti-poussière | No Dust  
K 520 - Q 521 - D 522 - S 523

1 position de matelas à 10,25" du plancher  
1 mattress position at 10,25" from the floor

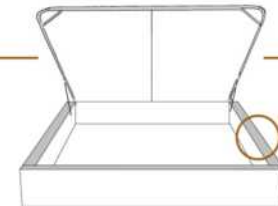

Avec rangement | With Storage  
\*\*1" plus large | \*\*1" wider  
K 530 - Q 531

1 position de matelas à 10,25" du plancher  
1 mattress position at 10,25" from the floor



Lit réglable | Adjustable bed  
Pattes de bois seulement | Wood leg only  
K 560 - Q 561 - S 563

|      | King     | Queen    | Simple Single |
|------|----------|----------|---------------|
| EXT: | 87x88x49 | 69x88x49 | 49x88x49      |
| INT: | 78x82x12 | 61x82x12 | 40x82x12      |



Rangement à tiroir frontal  
With Front Drawer  
K 540 - Q 541 - D 542

1 position de matelas à 10,25" du plancher  
1 mattress position at 10,25" from the floor



Rangement à tiroir latéraux  
With Side Drawers  
K 550 - Q 551 (2 tiroirs | drawers)  
D 552 - S 553 (1 tiroir | drawer)

1 position de matelas à 10,25" du plancher  
1 mattress position at 10,25" from the floor

Les illustrations sont génériques et n'indiquent pas tous les détails de coutures. | The sketches are generic and do not reflect all sewing details.



Lits rembourrés  
*Upholstered Beds*

## CDN Price List



## ROBIN

### GROUP C

Headboard with NO wings - CHOOSE your BED BASE - See 99900 BASE L price list.

FEATURES: Adjustable headboard cushions 2 positions.

COMBO: Cover #1: Whole Bed. Cover #2: Adjustable headboard cushions.

Finished BACK of HEADBOARD add:

- in LEATHER: King \$175, Queen \$145.

- in FABRIC: King \$55, Queen \$50.

| Description         | L x D x H   | Leather |                       |  |  |                                  |                           | Fabric |          |           |
|---------------------|-------------|---------|-----------------------|--|--|----------------------------------|---------------------------|--------|----------|-----------|
|                     |             | 10      | 20<br>Madras<br>Softy | 30<br>Hugo<br>Fantasy<br>Illusion<br>Tucson<br>Utah<br>Vintage<br>Wild Laredo<br>Yukon | 40<br>Elegance<br>Princess<br>Santiago<br>Sensation<br>Sunset<br>Trina<br>Victoria | 50<br>Bull<br>Cassiope<br>Dublin | 60<br>Caress<br>Ultrasued | A      | B<br>COM | C<br>alta |
| 400 KING HEADBOARD  | 87X12X46/41 | 1650    | 1785                  | 1920   | 2055   | 2190                             | 2325                      | 1060   | 1115     | 1170      |
| 401 QUEEN HEADBOARD | 69X12X46/41 | 1300    | 1405                  | 1510   | 1615   | 1720                             | 1825                      | 900    | 950      | 1000      |

# ROBIN



Tête de lit sans oreilles | Headboard without wings

400 King - 401 Queen

Pour les dimensions des bases; Voir la liste de prix 99900  
For the dimensions of the bed bases; See Price list 99900

## 4" Base contour LARGE | WIDE contour Base

### DIMENSIONS

Lit grandeur complète  
Complete bed size

Base: 12" Haut | Height

L x P/D x H

87" x 98" x 46/41"

69" x 98" x 46/41"

K  
Q



\*Avec pattes | \*With Legs  
K 410 - Q 411

2 positions de matelas à 9,75" ou 6,5" du plancher  
2 mattress position from 9,75" or 6,5" from the floor



Anti-poussière | No Dust  
K 420 - Q 421

2 positions de matelas à 9,75" ou 6,5" du plancher  
2 mattress position from 9,75" or 6,5" from the floor

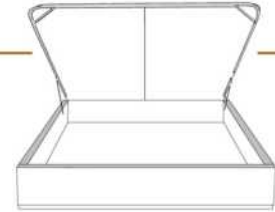

Avec rangement | With Storage  
K 430 - Q 431

1 position de matelas à 10,25" du plancher  
1 mattress position at 10,25" from the floor



Rangement à tiroir frontal  
With Front Drawer  
K 440 - Q 441

1 position de matelas à 10,25" du plancher  
1 mattress position at 10,25" from floor



Rangement à tiroir latéraux  
With Side Drawers  
K 450 - Q 451 (2 tiroirs | drawers)

1 position de matelas à 10,25" du plancher  
1 mattress position at 10,25" from floor

## 2" Base contour MINCE | NARROW contour Base

### DIMENSIONS

Lit grandeur complète  
Complete bed size

Base: 12" Haut | Height

L x P/D x H

87" x 96" x 46/41"

69" x 96" x 46/41"

K  
Q



\*Avec pattes | \*With Legs  
K 510 - Q 511

1 position de matelas à 10,25" du plancher  
1 mattress position at 10,25" from floor



Anti-poussière | No Dust  
K 520 - Q 521

1 position de matelas à 10,25" du plancher  
1 mattress position at 10,25" from floor

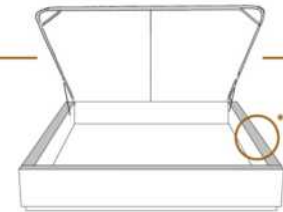

Avec rangement | With Storage  
\*\*1" plus large | \*\*1" wider  
K 530 - Q 531

1 position de matelas à 10,25" du plancher  
1 mattress position at 10,25" from floor



Lit réglable | Adjustable bed  
Pattes de bois seulement | Wood leg only  
K 560 - Q 561

King Queen  
EXT: 87x96x46/41 69x96x46/41  
INT: 78x82x12 61x82x12



Rangement à tiroir frontal  
With Front Drawer  
K 540 - Q 541

1 position de matelas à 10,25" du plancher  
1 mattress position at 10,25" from floor



Rangement à tiroir latéraux  
With Side Drawers  
K 550 - Q 551 (2 tiroirs | drawers)

1 position de matelas à 10,25" du plancher  
1 mattress position at 10,25" from floor

Les illustrations sont génériques et n'indiquent pas tous les détails de coutures. | The sketches are generic and do not reflect all sewing details.





Lits rembourrés  
*Upholstered Beds*

## CDN Price List



## SOFIA

### GROUP C

Headboard with NO wings - Choose your bed base - See 99900 BASE L price list.

### OPTIONS:

Decorative Nails: MEDIUM ½" nails around contour of appliqué, ADD: King \$95, Queen \$85, Double \$80, Simple \$75.  
Specify nail colour on your order: BRASS-SILVER-PEWTER or COPPER.

COMBO available: Appliqué can be made with contrasting colour. Refer to "COMBO" chart in Product Knowledge booklet.

### Finished BACK of HEADBOARD add:

- in LEATHER: King \$175, Queen \$145, Double \$135, Single \$105.
- in FABRIC: King \$55, Queen \$50, Double \$45, Single \$35.

| Description          | L x D x H | Leather |                       |  |   |                                  |                           | Fabric |          |           |
|----------------------|-----------|---------|-----------------------|--|---|----------------------------------|---------------------------|--------|----------|-----------|
|                      |           | 10      | 20<br>Madras<br>Softy | 30<br>Hugo<br>Fantasy<br>Illusion<br>Tucson<br>Utah<br>Vintage<br>Wild Laredo<br>Yukon | 40<br>Elegance<br>Princess<br>Santiago<br>Sensation | 50<br>Bull<br>Cassiope<br>Dublin | 60<br>Caress<br>Ultrasued | A      | B<br>COM | C<br>alta |
| 400 KING HEADBOARD   | 87X6X56   | 1650    | 1785                  | 1920   | 2055  | 2190                             | 2325                      | 1060   | 1115     | 1170      |
| 401 QUEEN HEADBOARD  | 69X6X56   | 1300    | 1405                  | 1510   | 1615  | 1720                             | 1825                      | 900    | 950      | 1000      |
| 402 DOUBLE HEADBOARD | 64X6X56   | 1245    | 1345                  | 1445   | 1545  | 1645                             | 1745                      | 825    | 870      | 915       |
| 403 SINGLE HEADBOARD | 49X6X56   | 960     | 1040                  | 1120   | 1200  | 1280                             | 1360                      | 655    | 685      | 715       |

# SOFIA

Tête de lit avec oreilles | Headboard with wings

400 King - 401 Queen - 402 Double - 403 Simple | Single

Pour les dimensions des bases; Voir la liste de prix 99900  
For the dimensions of the bed bases; See Price list 99900

Option de clous | Nail options



Silver - Copper - Pewter - Brass  
1/2" diamètre



## 4" Base contour LARGE | WIDE contour Base

### DIMENSIONS

Lit grandeur complète  
Complete bed size

Base: 12" Haut | Height

L x P/D x H

|   |                 |
|---|-----------------|
| K | 87" x 91" x 56" |
| Q | 69" x 91" x 56" |
| D | 64" x 87" x 56" |
| S | 49" x 87" x 56" |



\* Avec pattes | \*With Legs  
K 410 - Q 411 - D 412 - S 413

2 positions de matelas à 9,75" ou 6,5" du plancher  
2 mattress position from 9,75" or 6,5" from the floor



Anti-poussière | No Dust  
K 420 - Q 421 - D 422 - S 423

2 positions de matelas à 9,75" ou 6,5" du plancher  
2 mattress position from 9,75" or 6,5" from the floor



Avec rangement | With Storage  
K 430 - Q 431

1 position de matelas à 10,25" du plancher  
1 mattress position at 10,25" from the floor



Rangement à tiroir frontal  
With Front Drawer  
K 440 - Q 441 - D 442

1 position de matelas à 10,25" du plancher  
1 mattress position at 10,25" from floor



Rangement à tiroir latéraux  
With Side Drawers  
K 450 - Q 451 (2 tiroirs | drawers)  
D 452 - S 453 (1 tiroir | drawer)

1 position de matelas à 10,25" du plancher  
1 mattress position at 10,25" from floor

## 2" Base contour MINCE | NARROW contour Base

### DIMENSIONS

Lit grandeur complète  
Complete bed size

Base: 12" Haut | Height

L x P/D x H

|   |                 |
|---|-----------------|
| K | 87" x 89" x 56" |
| Q | 69" x 89" x 56" |
| D | 64" x 85" x 56" |
| S | 49" x 85" x 56" |



\* Avec pattes | \*With Legs  
K 510 - Q 511 - D 512 - S 513

1 position de matelas à 10,25" du plancher  
1 mattress position at 10,25" from floor



Anti-poussière | No Dust  
K 520 - Q 521 - D 522 - S 523

1 position de matelas à 10,25" du plancher  
1 mattress position at 10,25" from floor

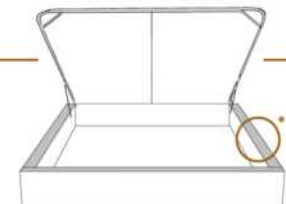

Avec rangement | With Storage  
\*\*1" plus large | \*\*1" wider  
K 530 - Q 531

1 position de matelas à 10,25" du plancher  
1 mattress position at 10,25" from floor



Lit réglable | Adjustable bed  
Pattes de bois seulement | Wood leg only  
K 560 - Q 561 - S 563

|      |          |          |               |
|------|----------|----------|---------------|
|      | King     | Queen    | Simple/Single |
| EXT: | 87x90x56 | 69x90x56 | 49x90x56      |
| INT: | 78x82x12 | 61x82x12 | 40x82x12      |



Rangement à tiroir frontal  
With Front Drawer  
K 540 - Q 541 - D 542

1 position de matelas à 10,25" du plancher  
1 mattress position at 10,25" from floor



Rangement à tiroir latéraux  
With Side Drawers  
K 550 - Q 551 (2 tiroirs | drawers)  
D 552 - S 553 (1 tiroir | drawer)

1 position de matelas à 10,25" du plancher  
1 mattress position at 10,25" from floor

Les illustrations sont génériques et n'indiquent pas tous les détails de coutures. | The sketches are generic and do not reflect all sewing details.



## VOILA BED

Decorative pillows are not included with this model

Features: Bed has channel on its perimeter where backs and Traynite niteshelves can be inserted.

IMPORTANT: Specify color of legs LG96 and Traynite.

Each bed base includes 1 posture board.

Recommended size mattress: 8 to 10 inches thick.

| Description                 | L x D x H     | Leather |                       |  |  |                                  |                           | Fabric |          |           |
|-----------------------------|---------------|---------|-----------------------|--|--|----------------------------------|---------------------------|--------|----------|-----------|
|                             |               | 10      | 20<br>Madras<br>Softy | 30<br>Hugo<br>Fantasy<br>Illusion<br>Tucson<br>Utah<br>Vintage<br>Wild Laredo<br>Yukon | 40<br>Elegance<br>Princess<br>Santiago<br>Sensation<br>Sunset<br>Trina<br>Victoria | 50<br>Bull<br>Cassiope<br>Dublin | 60<br>Caress<br>Ultrasued | A      | B<br>COM | C<br>alta |
| 131 BED BACK                | 28X11X18      | 325     | 385                   | 445  | 505  | 565                              | 625                       | 195    | 215      | 235       |
| 150 LARGE PILLOW            | 22X22         |         |                       |  |  |                                  |                           | 75     | 100      | 125       |
| 314 SINGLE BED              | 56x92x13.5/33 | 1325    | 1490                  | 1655   | 1820   | 1985                             | 2150                      | 1030   | 1090     | 1150      |
| 321 TRAYNITE *WOOD*         | 16 DIAM. X 15 | 120     | 120                   | 120  | 120  | 120                              | 120                       | 120    | 120      | 120       |
| 322 TRAYCOOL *WOOD & METAL* | 16 DIAM. x 15 | 120     | 120                   | 120  | 120  | 120                              | 120                       | 120    | 120      | 120       |
| 360 QUEEN BED               | 77x97x13.5/33 | 1395    | 1575                  | 1755   | 1935   | 2115                             | 2295                      | 1070   | 1135     | 1200      |
| 380 KING BED                | 95x97x13.5/33 | 1615    | 1815                  | 2015   | 2215   | 2415                             | 2615                      | 1185   | 1260     | 1335      |

# VOILÀ

Lit voilà Bed items

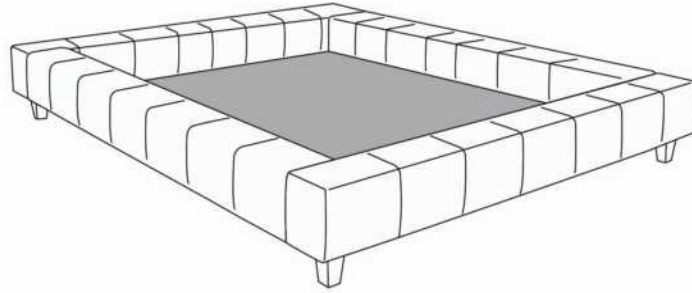

Base de Lit/Bed base

372 California King (US only/seulement) | 380 King | 360 Queen | 314 Simple/ Single

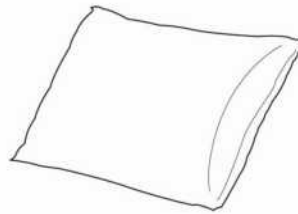

Grand Coussin/Large pillow  
150

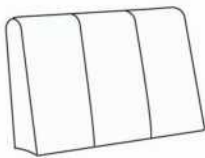

Dos lit/Bed back  
131



Traynite  
321

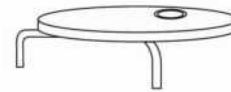

Traycool  
322

Les illustrations sont génériques et n'indiquent pas tous les détails de coutures.  
The sketches are generic and do not reflect all sewing details.

R2014-03



## WAVE

LEGS: Specify colour of legs LG174 for ITEMS 380, 360, 304 & 314.

ITEMS: 380, 360, 304 & 314 include 3 wood slats with central legs preinstalled at high position 8 1/2 " overall height. Adjustable to a lower position (6" overall height) includes three 4 1/2" central legs. Posture board included.

BEDS WITH STORAGE: Plywood posture board included.

OPTION: Finished BACK of HEADBOARD add:  
In LEATHER: King \$175, Queen \$145, Double \$135, Single \$105.  
In FABRIC: King \$55, Queen \$50, Double \$45, Single \$35.

| Description                 | L x D x H    | Leather |                       |  |  |                                  |                           | Fabric |          |           |
|-----------------------------|--------------|---------|-----------------------|--|--|----------------------------------|---------------------------|--------|----------|-----------|
|                             |              | 10      | 20<br>Madras<br>Softy | 30<br>Hugo<br>Fantasy<br>Illusion<br>Tucson<br>Utah<br>Vintage<br>Wild Laredo<br>Yukon | 40<br>Elegance<br>Princess<br>Santiago<br>Sensation<br>Sunset<br>Trina<br>Victoria | 50<br>Bull<br>Cassiope<br>Dublin | 60<br>Caress<br>Ultrasued | A      | B<br>COM | C<br>alta |
| 304 DOUBLE BED              | 72X 92X41/11 | 1900    | 2035                  | 2170   | 2305   | 2440                             | 2575                      | 1230   | 1295     | 1360      |
| 314 SINGLE BED              | 57X92X41/11  | 1695    | 1835                  | 1975   | 2115   | 2255                             | 2395                      | 1125   | 1185     | 1245      |
| 360 QUEEN BED               | 78X96X41/11  | 2060    | 2215                  | 2370   | 2525   | 2680                             | 2835                      | 1300   | 1365     | 1430      |
| 365 KING BED WITH STORAGE   | 94X96X41/11  | 2650    | 2825                  | 3000   | 3175   | 3350                             | 3525                      | 1880   | 1955     | 2030      |
| 366 QUEEN BED WITH STORAGE  | 78X96X41/11  | 2235    | 2385                  | 2535   | 2685   | 2835                             | 2985                      | 1645   | 1720     | 1795      |
| 367 DOUBLE BED WITH STORAGE | 72X92X41/11  | 2060    | 2200                  | 2340   | 2480   | 2620                             | 2760                      | 1560   | 1630     | 1700      |
| 368 SINGLE BED WITH STORAGE | 57X92X41/11  | 1875    | 2010                  | 2145   | 2280   | 2415                             | 2550                      | 1450   | 1525     | 1600      |
| 380 KING BED                | 94X96X41/11  | 2390    | 2570                  | 2750   | 2930   | 3110                             | 3290                      | 1420   | 1500     | 1580      |

# Lit **WAVE** Bed

## Lit régulier | Regular Bed

380 King | 360 Queen | 304 Double | 314 Simple/ Single

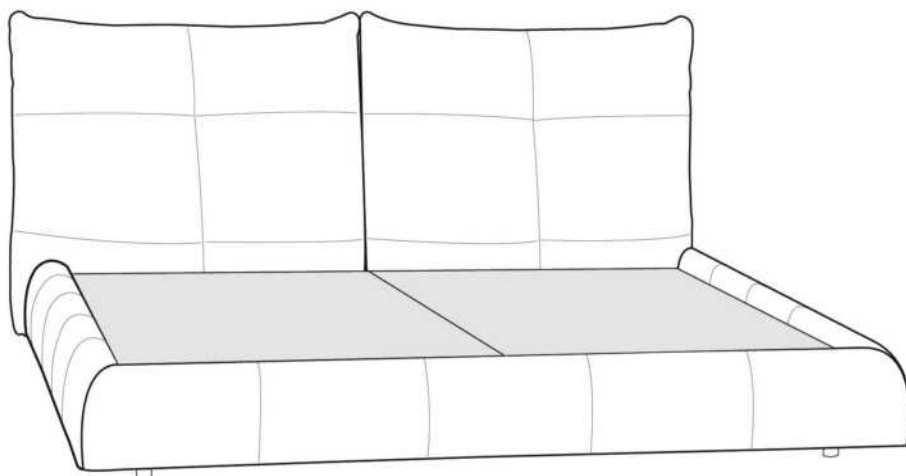

## Lit avec rangement | Bed with storage

365 King | 366 Queen | 367 Double | 368 Simple/ Single

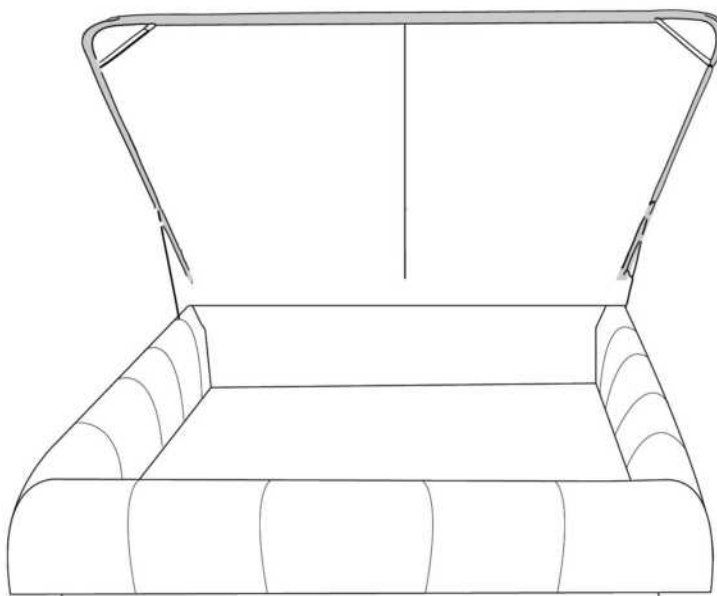

[www.jaymar.ca](http://www.jaymar.ca)

Les illustrations sont génériques et n'indiquent pas tous les détails de coutures.  
The sketches are generic and do not reflect all sewing details.

R: 2016-02



Lits rembourrés  
*Upholstered Beds*

## CDN Price List



## ZEN

### GROUP C

Headboard with NO wings - CHOOSE your BED BASE - See 99900 BASE L price list.

FEATURES: Adjustable headboard cushions 3 positions.

Finished BACK of HEADBOARD add:

- in LEATHER: King \$175, Queen \$145.

- in FABRIC: King \$55, Queen \$50.

| Description         | L x D x H   | Leather |                       |  |  |                                  |                           | Fabric |          |           |
|---------------------|-------------|---------|-----------------------|--|--|----------------------------------|---------------------------|--------|----------|-----------|
|                     |             | 10      | 20<br>Madras<br>Softy | 30<br>Hugo<br>Fantasy<br>Illusion<br>Tucson<br>Utah<br>Vintage<br>Wild Laredo<br>Yukon | 40<br>Elegance<br>Princess<br>Santiago<br>Sensation<br>Sunset<br>Trina<br>Victoria | 50<br>Bull<br>Cassiope<br>Dublin | 60<br>Caress<br>Ultrasued | A      | B<br>COM | C<br>alta |
| 400 KING HEADBOARD  | 87 x 9 x 47 | 1650    | 1785                  | 1920   | 2055   | 2190                             | 2325                      | 1060   | 1115     | 1170      |
| 401 QUEEN HEADBOARD | 69 x 9 x 47 | 1300    | 1405                  | 1510   | 1615   | 1720                             | 1825                      | 900    | 950      | 1000      |

# ZEN

Tête de lit sans oreilles | Headboard without wings

400 King - 401 Queen

Pour les dimensions des bases; Voir la liste de prix 99900  
For the dimensions of the bed bases; See Price list 99900

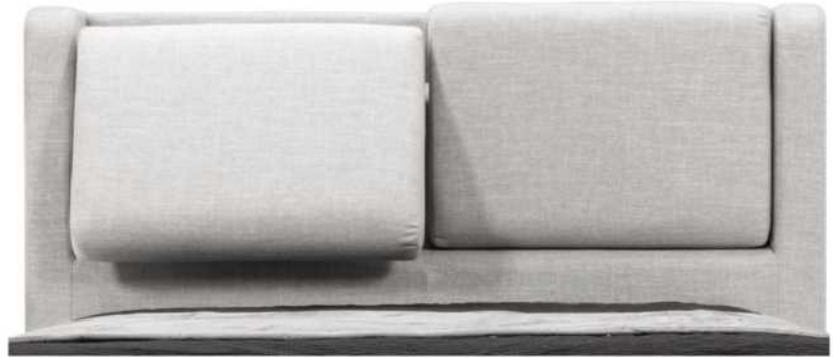

## 4" Base contour LARGE | WIDE contour Base

**DIMENSIONS**  
Lit grandeur complète  
Complete bed size

Base: 12" Haut | Height

**L x P/D x H**

87" x 95" x 47"

69" x 95" x 47"

K  
Q



\*Avec pattes | \*With Legs  
K 410 - Q 411

2 positions de matelas à 9,75" ou 6,5" du plancher  
2 mattress position from 9,75" or 6,5" from the floor



Anti-poussière | No Dust  
K 420 - Q 421

2 positions de matelas à 9,75" ou 6,5" du plancher  
2 mattress position from 9,75" or 6,5" from the floor

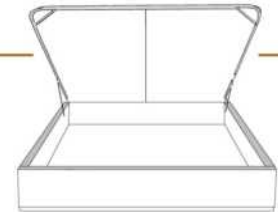

Avec rangement | With Storage  
K 430 - Q 431

1 position de matelas à 10,25" du plancher  
1 mattress position at 10,25" from the floor



Rangement à tiroir frontal  
With Front Drawer  
K 440 - Q 441

1 position de matelas à 10,25" du plancher  
1 mattress position at 10,25" from the floor



Rangement à tiroir latéraux  
With Side Drawers  
K 450 - Q 451 (2 tiroirs | drawers)

1 position de matelas à 10,25" du plancher  
1 mattress position at 10,25" from the floor

## 2" Base contour MINCE | NARROW contour Base

**DIMENSIONS**  
Lit grandeur complète  
Complete bed size

Base: 12" Haut | Height

**L x P/D x H**

87" x 93" x 47"

69" x 93" x 47"

K  
Q



\*Avec pattes | \*With Legs  
K 510 - Q 511

1 position de matelas à 10,25" du plancher  
1 mattress position at 10,25" from the floor



Anti-poussière | No Dust  
K 520 - Q 521

1 position de matelas à 10,25" du plancher  
1 mattress position at 10,25" from the floor

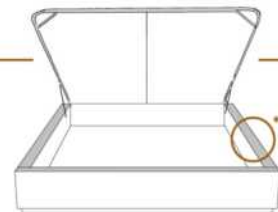

Avec rangement | With Storage  
\*\*1" plus large | \*\*1" wider  
K 530 - Q 531

1 position de matelas à 10,25" du plancher  
1 mattress position at 10,25" from the floor

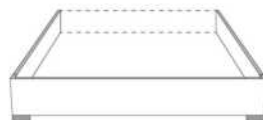

Lit réglable | Adjustable bed  
Pattes de bois seulement | Wood leg only  
K 560 - Q 561

|      |          |          |
|------|----------|----------|
|      | King     | Queen    |
| EXT: | 87x93x47 | 69x93x47 |
| INT: | 78x82x12 | 61x82x12 |



Rangement à tiroir frontal  
With Front Drawer  
K 540 - Q 541

1 position de matelas à 10,25" du plancher  
1 mattress position at 10,25" from the floor



Rangement à tiroir latéraux  
With Side Drawers  
K 550 - Q 551 (2 tiroirs | drawers)

1 position de matelas à 10,25" du plancher  
1 mattress position at 10,25" from the floor

Les illustrations sont génériques et n'indiquent pas tous les détails de coutures. | The sketches are generic and do not reflect all sewing details.