



BERLIN



Conçu et fabriqué fièrement au Canada
Proudly designed and made in Canada

OPTIMA

Collection

Nos produits sont fabriqués à la main et des variations mineures peuvent survenir.
Our product is hand-made and minor variations can occur.

FAUTEUIL BERÇANT PIVOTANT INCLINABLE SWIVEL ROCKING MOTION CHAIR

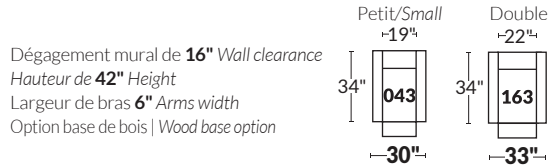

SPECIFICATIONS

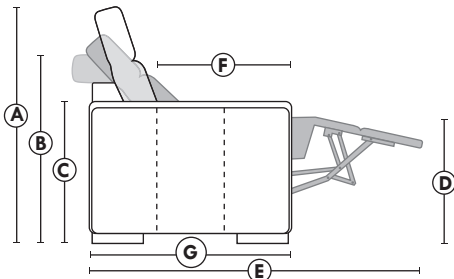

- Appui-tête levé Headrest up
- Appui-tête baissé Headrest down
- Complètement incliné Fully reclined

- A** Hauteur complète 40" Total Height
- B** Hauteur appui-tête baissé 33" Height headrest down
- C** Hauteur du bras 24" Arm Height
- D** Hauteur du siège 19,5" Seat height
- E** Profondeur incliné 65" Depth fully reclined
- F** Profondeur d'assise 20" ou/ or 22" Seat depth
- G** Profondeur appui-tête monté 37,5" Depth with headrest up

BRAS | ARMS

Option de bras:
Bras Régulier Large 10,5" ou Petit bras 6"

Arm option
Regular arm Large 10,5" or Small arm 6"

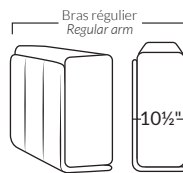

Contrôleur de l'inclinaison situé à l'intérieur du bras
Recliner control located on the inside of the arm.

Option d'accessoires disponible sur
le bras régulier seulement
Accessories option, available on Regular arms ONLY.

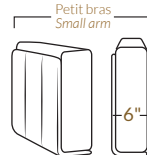

SIÈGE 23" DE LARGE | 23" SEAT WIDTH

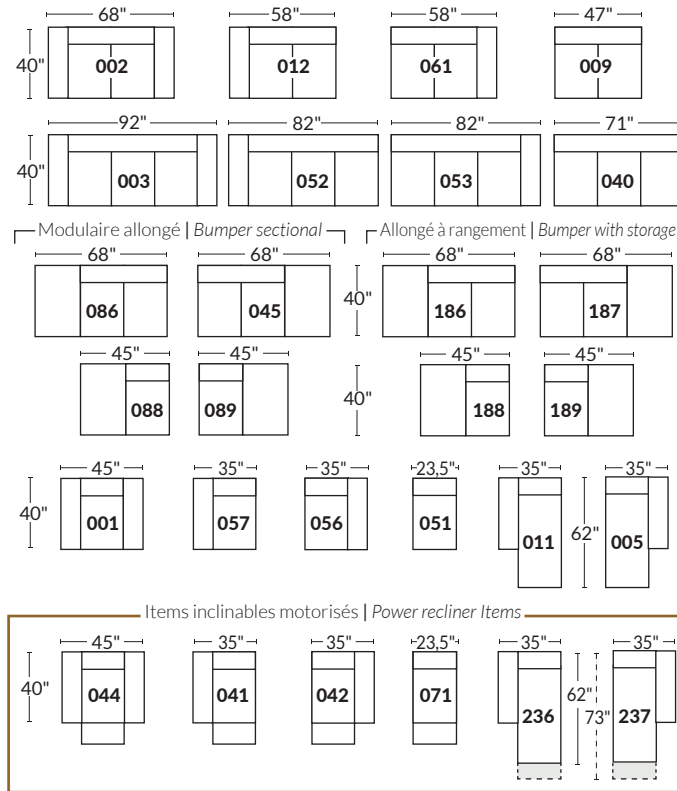

Items inclinables motorisés | Power recliner Items

SIÈGE 30" DE LARGE | 30" SEAT WIDTH

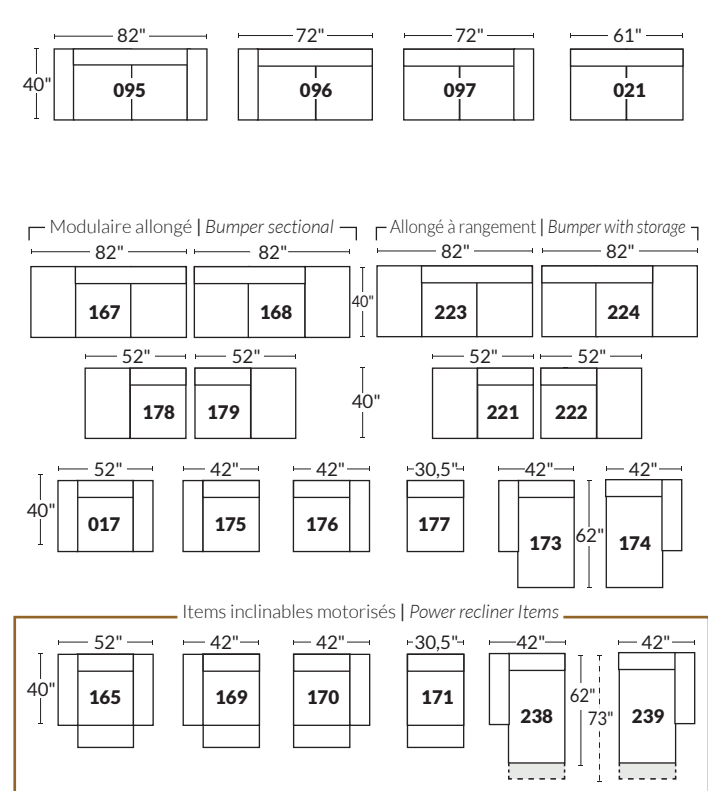

Items inclinables motorisés | Power recliner Items

Autres | Others

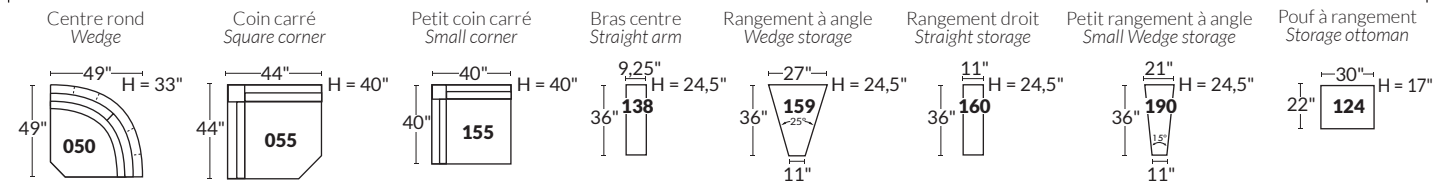

EXEMPLE 23" EXAMPLE

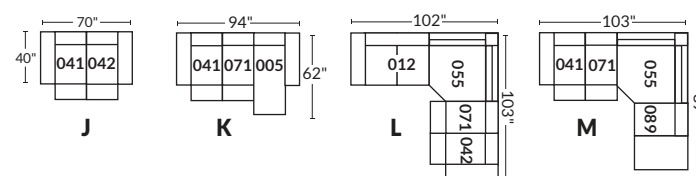

EXEMPLE 30" EXAMPLE

