











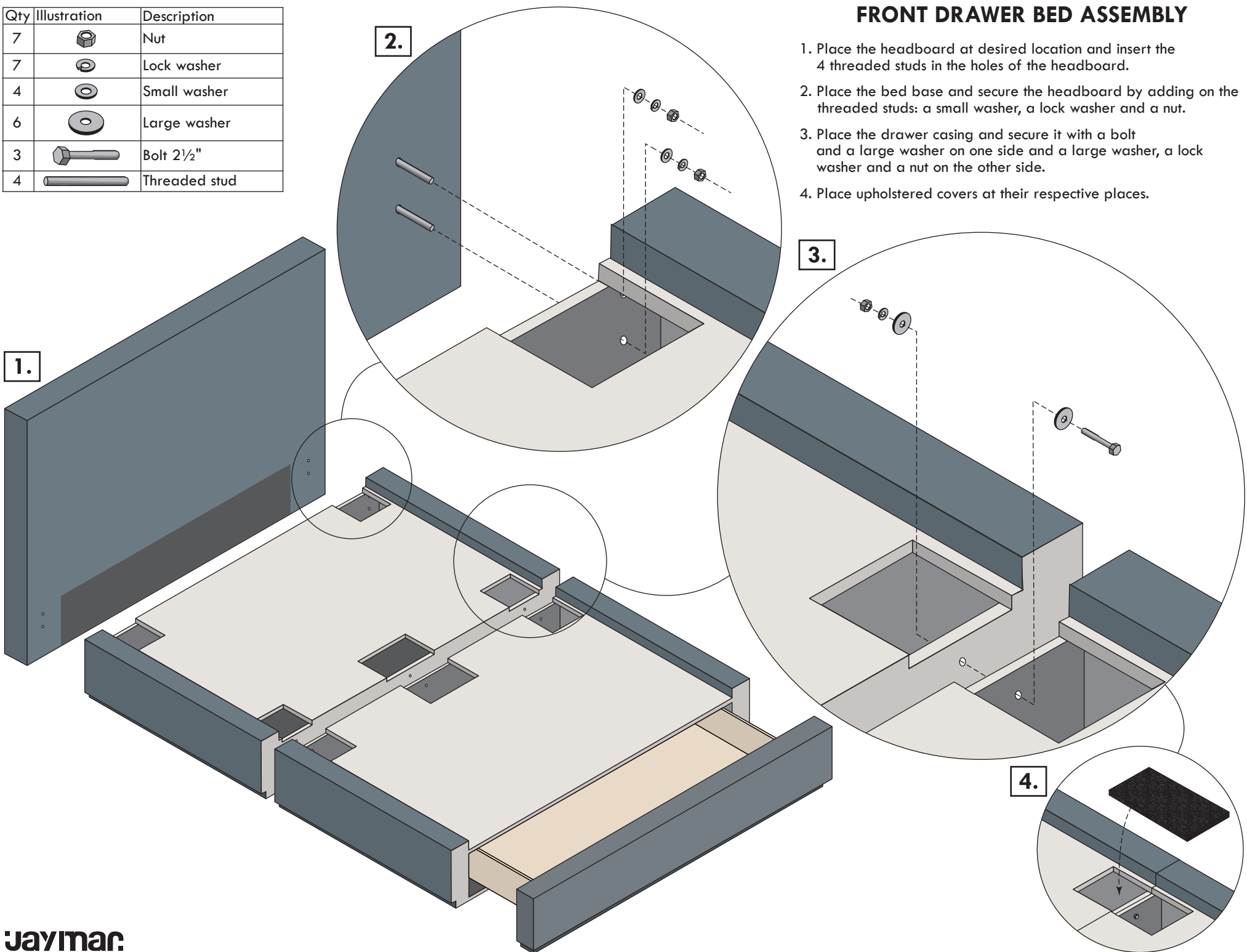

Qty	Illustration	Description
7		Nut
7		Lock washer
4		Small washer
6		Large washer
3		Bolt 2 1/2"
4		Threaded stud

FRONT DRAWER BED ASSEMBLY

1. Place the headboard at desired location and insert the 4 threaded studs in the holes of the headboard.
2. Place the bed base and secure the headboard by adding on the threaded studs: a small washer, a lock washer and a nut.
3. Place the drawer casing and secure it with a bolt and a large washer on one side and a large washer, a lock washer and a nut on the other side.
4. Place upholstered covers at their respective places.







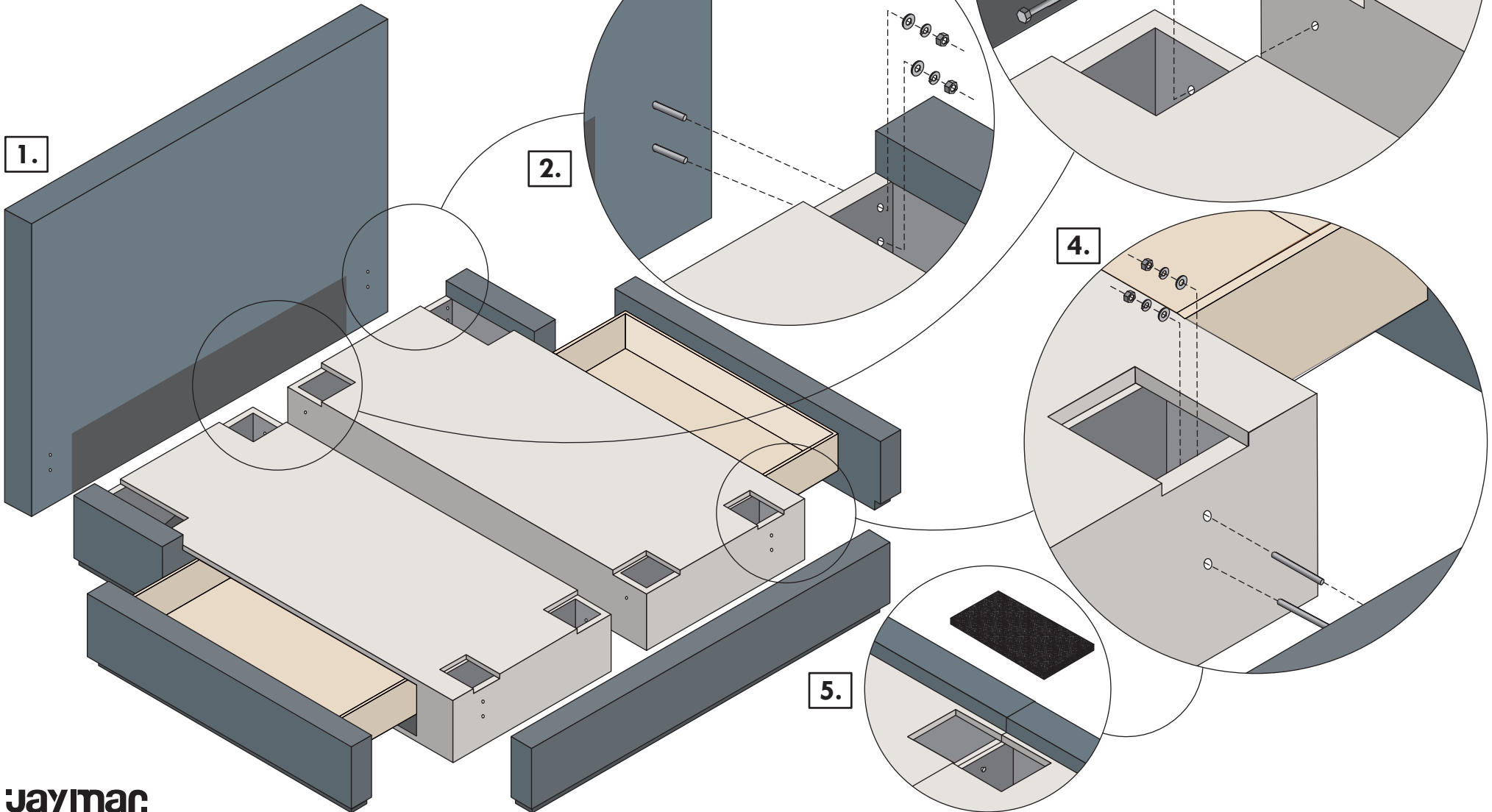

Qty	Illustration	Description
10		Nut
10		Lock washer
8		Small washer
4		Large washer
2		Bolt 2 1/2"
8		Threaded stud

SIDE DRAWER BED ASSEMBLY

1. Place the headboard at desired location and insert the 4 threaded studs in the holes of the headboard.
2. Place the 2 drawer casings and secure them to the headboard by adding to the threaded studs: a small washer, a lock washer and a nut.
3. Secure the 2 drawer casings together with a bolt and large washer on one side and a large washer, a lock washer and a nut on the other side.
4. Insert the 4 threaded studs in the holes of the foot rail and secure it to 2 drawer casings with a small washer, a lock washer and a nut.
5. Place upholstered covers at their respective places.









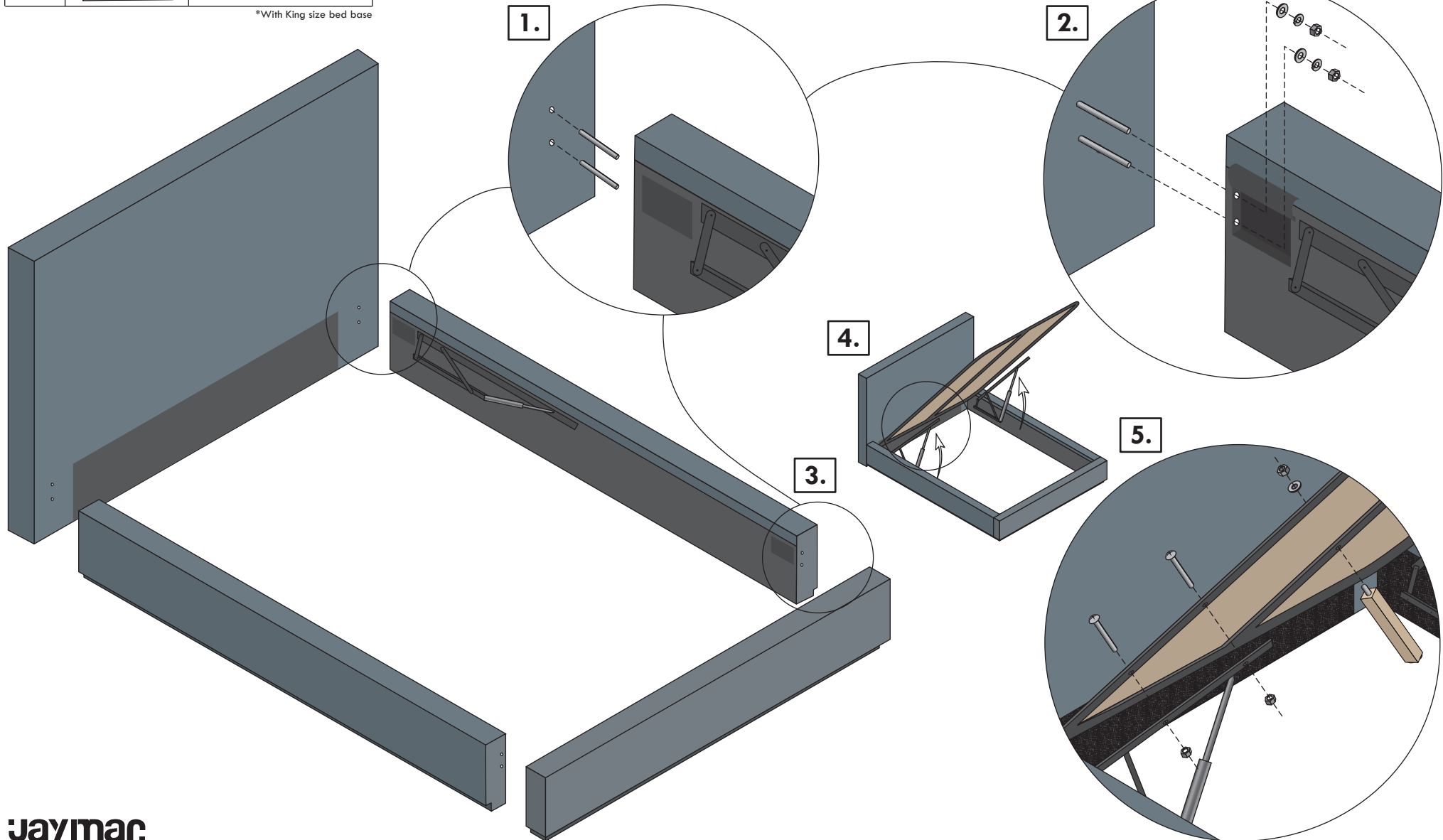

STORAGE BED BASE ASSEMBLY

Qty	Illustration	Description
12-14*		Nut
8-10*		Lock washer
8		Small washer
4		Round head bolt
8		Threaded stud
3*		Support leg

*With King size bed base

- Place headboard at desired location and insert the 4 threaded studs in the holes of the headboard.
- Place the sides rails and secure it to the headboard by adding on the threaded studs: a small washer, a lock washer and a nut. Do not tighten too firmly.
- Repeat steps 1 and 2 for footboard.
- Remove the plastic tie to from the hinges and cylinder. Once the hinges are assembled, place the plywood posture board on top of the support rails.
- Insert all bolts (two on each side) and tighten firmly with the nuts provided.
- Place your mattress.²
 - To avoid breaking the leg supports, screw the levelers before moving the bed.
 - The storage bed mechanism closes only with the weight of the mattress.



Qty	Illustration	Description
8		Nut
8		Lock washer
8		Wide washer
8		Threaded stud
3		Support leg 5" ³ / ₈
3		Support leg 8" ⁵ / ₈
3		Wood slat

WIDE BED BASE ASSEMBLY





1. Place headboard at desired location and insert the 4 threaded studs in the holes of the headboard.
2. Place the sides rails and secure the headboard by adding on the threaded studs: a small washer, a lock washer and a nut. Do not tighten too firmly.
3. Repeat steps 1 and 2 for footboard.
4. Fasten the wood legs to the wood slats.¹

5. Insert wood slat part in the brackets. Make sure to level the legs by unscrewing the leveler (black wheel) so that the leg touches the floor.²

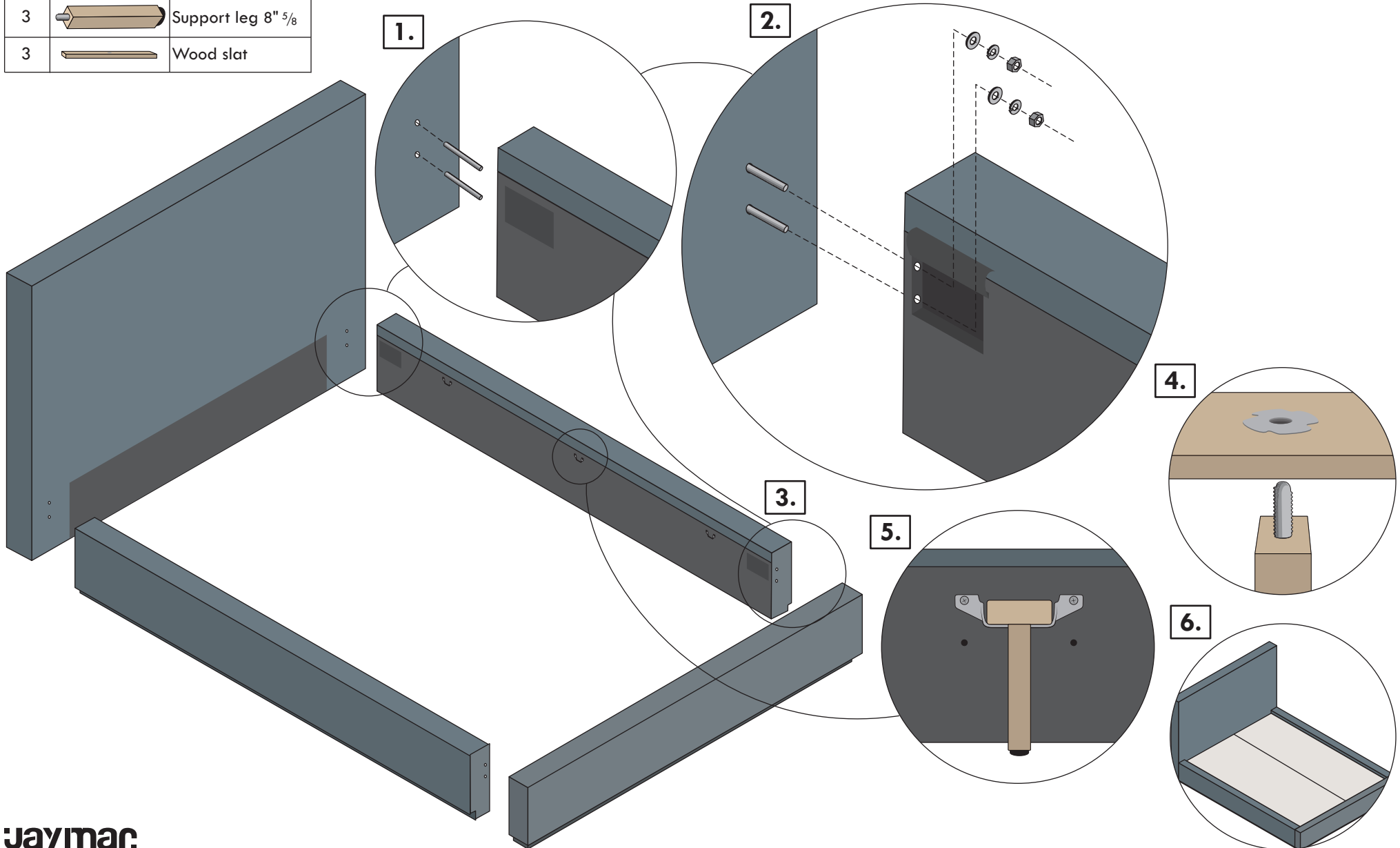
6. Tighten firmly the nuts, place the posture board and your mattress.

1. If you want your mattress to be embedded, unscrew the two brackets screw in the other two holes meant for the 5" ³/₈ legs. Otherwise, use the 8" ⁵/₈ legs. ATTENTION: the metal "T" fastener must be on top of the wood slat.
2. To avoid breaking the leg supports, screw the levelers before moving the bed.

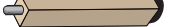

Qté	Illustration	Description
8		Nut
8		Lock washer
8		Small washer
8		Threaded stud
3		Support leg

NARROW BED BASE ASSEMBLY

1. Place headboard at desired location and insert the 4 threaded studs in the holes of the headboard.
 2. Place the sides rails and secure the headboard by adding on the threaded studs: a small washer, a lock washer and a nut. Do not tighten too firmly.
 3. Repeat steps 1 and 2 for footboard.
 4. Screw the support leg to the posture board.
 5. Place the posture board on the bed base and make sure to level the legs by unscrewing the leveler (black wheel) so that the leg touches the floor.¹
 6. Place your mattress.
1. To avoid breaking the leg supports, screw the levelers before moving the bed.

